

VitrA

ACRYLIC BATHTUBS

Installation Applications and User's Manual

CONTENTS

Foreword	3
General Characteristics of the Product	4
Bathtub Installation Applications.....	5
• Installation of Bathtubs with Panels.....	5
• Installation of Monobloc Bathtubs.....	7
• Massage Systems Implemented in VitrA Bathtubs.....	8
Maintenance of Bathtubs.....	10
• Matters Requiring Attention.....	10
• Problems You May Encounter and Their Solutions.....	10
• Cleaning of Acrylic Bathtubs.....	10
Matters Not Covered Under Warranty.....	11
• Transportation, Storage	11
• Installation.....	11
• Use, Cleaning and Maintenance.....	11

Manufacturer Company
Eczacıbaşı Yapı Gereçleri
San. ve Tic. A.Ş.
Şekerpinarı Cumhuriyet Mah.
İsmet İnönü Cad. No: 27
41420 Çayırova / Kocaeli
Tel : (0262) 648 95 00 (Pbx)
Faks: (0262) 658 85 94

General Distribution
Central Service
İntema A.Ş.
Kanyon Ofis Kat: 1819
Büyükdere Cad. No: 185
Levent 34394 İstanbul
Tel : 0212 371 70 00
Faks: 0212 353 13 9495

Consultancy Line
0850 311 70 70
0532 755 75 00

www.vitra.com.tr

This user manual applies to all VitrA Acrylic Bathtubs.
November 2015

Dear customers,

By ensuring a correct and purposeful use of this product which you have purchased, we would like it to deliver the best performance to you.

- 1- Accept the purchased product by removing it from its carton at our sales point and/or at the delivery to address and checking its parts one by one. If any missing materials or any breakage or damage is detected, inform the nearest Authorized Seller or the Authorized Service. In such cases, please protect the product in its original packaging.
- 2- Have the User Manual of the product which you have received without any missing parts or any damages APPROVED by the Authorized Seller.
- 3- We urge you to carefully read this guide in full before having our product installed and keep it for future reference.
- 4- Please call the Authorized Service after completing the preparations for the required infrastructure.
- 5- In the event you need service for installation, maintenance and repairs;
 - Ask from our seller for the telephone number of the Authorized Service in the area you are living in.
 - In places where we do not have a seller, you may get the necessary information from the telephone numbers given in the guide.
 - Ask the service personnel to display their "Vitra Artema Authorized Service Personnel Card". Do not let people without a personnel card perform the installation
 - At the completion of the process, the technician is obliged to write the 'Service Form' correctly and in detail and have you sign it and give a copy to you. Please keep the 'Service Form'.
 - Some Authorized Services may have been shut down in time. You can learn the most reliable address from our website at www.vitra.com.tr, which is continuously updated and/or by calling our consultancy lines at 0850 311 70 70 and 0532 755 75 00
 - The items above have great importance for determining people who work under the name of special service and who are not Authorized Services. Please take note of these.
- 6- In case our Seller or our Authorized Service cannot satisfy your request or complaint please contact the communications means provided within the guide.

Sincerely yours,

GENERAL CHARACTERISTICS OF THE PRODUCT

The highest quality polymethylacrylate, in other words, "Acrylic" is used as the primary material in the production of Vitra Acrylic Bathtub Systems. Acrylic which has a high wear resistance is preferred because it can be easily cleaned and does not host microorganisms.

Acrylic is known to be one of most accommodating materials for human nature. Having a flexible structure, acrylic maintains its resilience against impacts and does not deform. Any small scratches which might occur on the surface can easily be eliminated through polishing. Acrylic products do not lose their shine due to a homogenous distribution of color cells, and saves the "first day appearance" over years.

The acrylic plates used in the production of Vitra Acrylic Bathtubs meet the EN 263 Standards for Acrylic Plates and are supplied from Lucite International (ICI) which is one of the leading producers in the world. The plates are assured against wear and tear through a ten-year aging test conducted by TUBITAK.

Vitra meets the EN 274 standard in the Vitra Shower Trays which are manufactured in accordance with the TSEK – DIN249 – GOSS standards Acrylic Shower Tray standards.

The usage life of the product is 10 years as per the communiqué on "After-sale Services of Industrial products" published by TR the Ministry of Industry and Trade.

- **Vitra Compact Shower Units are under warranty for 2 years from the purchase date.**
- **In order for you to benefit from "2-year warranty" application please have the Warranty Certificate approved by the Intema Store or Intema Authorized Seller from which you purchase your product or the Vitra - Artema Authorized Service which installed your bathtub.**
- **For your Vitra Compact System to be covered by the "2-year warranty", its installation must be performed "free-of-charge" by a Vitra - Artema Authorized Service.**
- **In case of any problem, please contact the nearest Vitra-Artema Authorized Service.**

MATTERS REQUIRING ATTENTION DURING SHIPPING AND TRANSPORTATION

- 1- The products should be transported and placed according to the transportation and protection signs found on the package.
- 2- During the forklift carriage of products shipped in crates or cardboard packaging you should make use of pallets.
- 3- In order to prevent products from breaking during their storage and protection they should be placed in accordance with the direction indicated on the packaging and placing them on top of one another should be avoided.
- 4- Product parts removed from packages opened for the purpose of carrying to floors should be checked and carried in a protected manner.
- 5- The protective film cover over the product should not be removed before transportation, installation and repair transactions.

INSTALLATION OF BATHTUBS

Points that Require Attention:

- We recommend the bathtub to be installed after tiling the wall tiles and other construction related works in the bathroom are completed.
- The technical details of the bathtub is provided in the Technical Data Sheet.
- Faucets should be installed as shown on the Technical Data Sheet.
- If a wall-mounted bathtub mixer is preferred the appropriate mixer should be installed on the wall in accordance with the instructions provided in the Technical Data Sheet.
- It should be ensured that the floor tiles are even and the walls are straight (90 °) before starting installation.
- Cold and hot water connections must already be realized.
- If this is a hydromassage bathtub the electrical connection should be prepared as shown in the Technical Data Sheet.

Installation of Bathtubs with panels

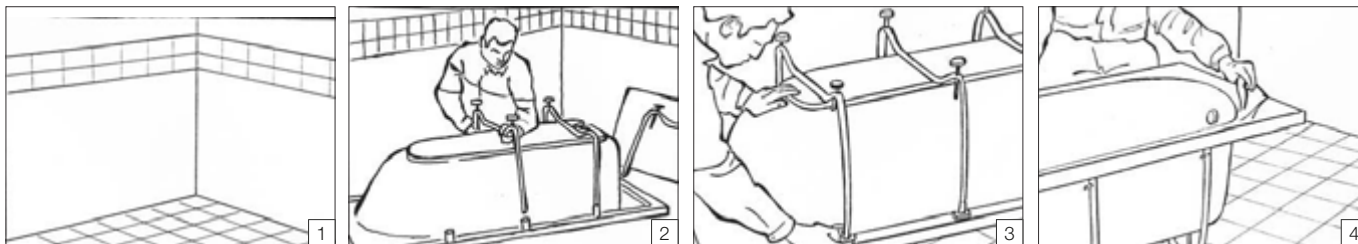

- 1- The bathtub should be installed to a structurally prepared floor.
- 2- If the bathtub is purchased with a packaging on pallets, the leg sets must be installed to the bathtub. In this case the leg profiles are prepared to be installed on the bathtub. The bathtub is placed upside down on a clean floor and the U shaped legs are inserted to the toggle and fixed to the bottom of the product via two screws.
- 3- The toggle screws are tightened.
- 4- Remove the protective folio of the bathtub from its sides that are touching the wall and from the area around the siphon.

(Note: The remaining protective folio on the bathtub should be removed only after the bathtub installation and other construction works in the bathroom are finished.)

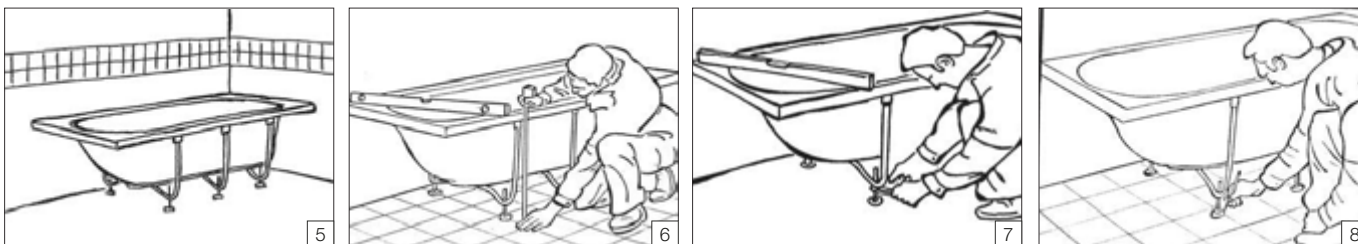

- 5- Place the bathtub to the installation area.
- 6- Adjust and level the leg set according to the height of the panel. Check the evenness with a scale. (See the Technical Data Sheet for the panel height).
- 7- Tighten the leg set nuts.
- 8- Mark the leg set installation holes (Caution! No hole should be drilled on heated and isolated floors!)

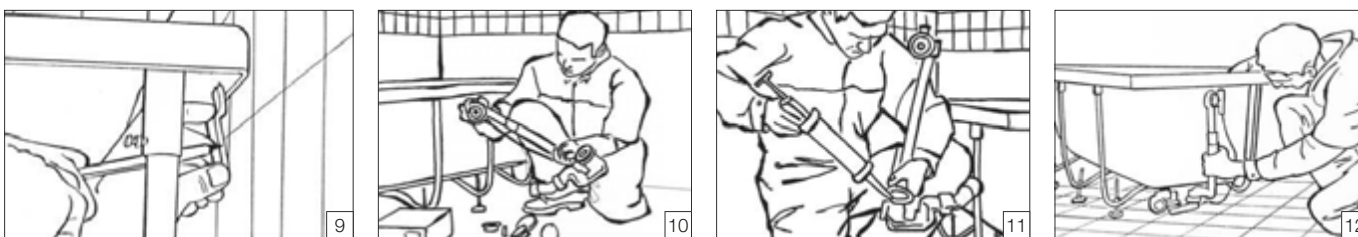

- 9- The points on the wall tiles which are marked for installing the wall hangers are drilled with a drilling machine (tip 10) and the wall hangers are fixed (The technical details are given in the "Wall Hanger Details" section of the Technical Data Sheet.)
- 10- Prepare the bathtub siphon for installation. (At this stage do not forget to remove protective folio on the bathtub around the siphon hole.)
- 11- Apply silicone on the siphon drain seal and the bearing seal,
- 12- Install the bathtub siphon you've prepared.

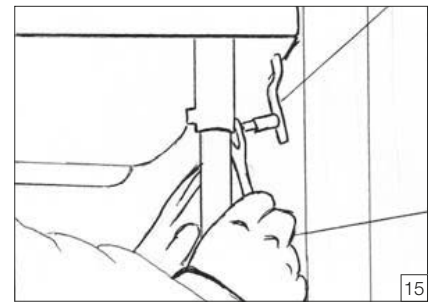
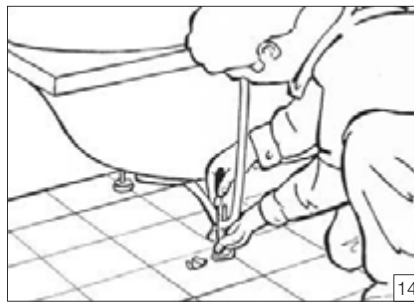

- 13- It is not required to fix the leg set of the bathtub to the floor when wall hangers are used. However for non-straight walls .the bathtub leg set. installation holes are drilled with a drilling machine (tip 7-8) (Caution: No hole should be drilled on heated and isolated floors.)
- 14- Screw the leg set to the floor.
- 15- The bathtub is fixed to the wall by tightening the cap screws of the wall hangers.

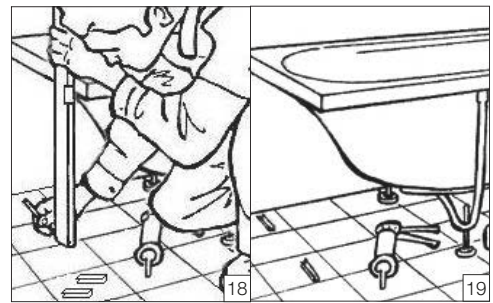
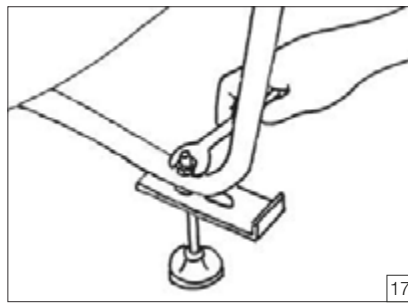
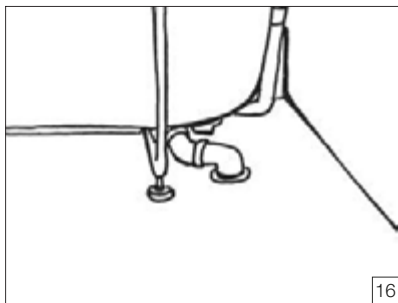

- 16- Siphon outlet is connected to the water drain. Perform leak proofing tests.
- 17- Panel supporting brackets are adjusted and screwed.
- 18-19- If the side panel will be used with the product, mark the floor where the panel supports are to be fixed and fix the panel supports to the floor using silicone.

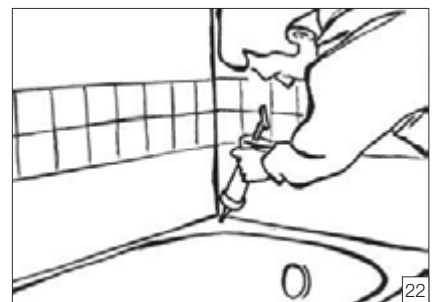

- 20- Remove the protective folio on the panels.
- Note: If this is a hydro massage bathtub, the electrical connection should be made.*
- 21- For rectangular bathtubs, first the side panel and later the front panel are installed to the bathtub. For corner bathtub panels, fixed metal clips are available for panel installation under the front side rims of bathtub to fix the panel. The panel's installation is started from one corner by attaching the top band of the panel to these clips.
- 22- Silicone is applied between the bathtub and the wall in order to prevent any leakage

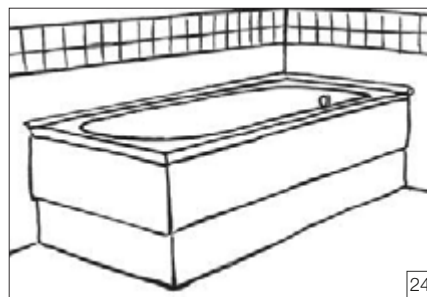

- 23- Additional edge lath application can be carried out if required. However isolation between wall and bathtub must be ensured before the application of edge lath. The edge lath is installed by applying silicone along the length of both surfaces of the edge lath which will come into contact with the bathtub and the wall.
- 24- The installation of the bathtub is complete. Any protective folio remaining on the bathtub should be removed only after all of the construction works in the bathroom are finished.

Installation of Monobloc Bathtubs

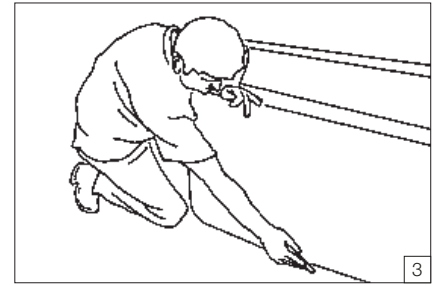
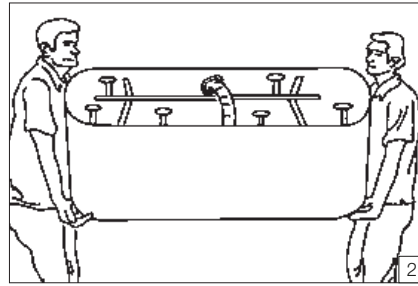
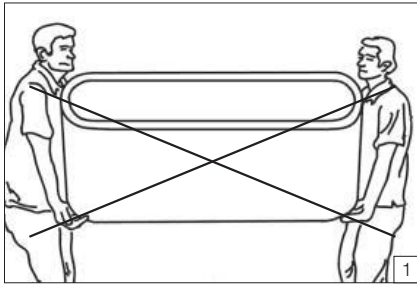

1-2 Bathtub must be carried upside down. It must never be carried by holding from its panel.

3- In this series a 'hidden overflow' is installed to plain and hydro massage bathtubs by the manufacturer. Therefore the product comes with the siphon installed. The bathtub is placed on the installation area and the perimeter of its bottom is marked. Inside the marked area, the 50 mm diameter waste water drain pipe is installed from the center shown in the drawing, at the point indicated by the letter "A", and the water inlet pipes are installed to the centerline of the faucet above the bathtub, at the point indicated by the letter "C", as illustrated in the technical diagram. If this is a hydro massage (hydro massage) bathtub, a 220 V phase, neutral and earth electric lines are required to be connected inside the marked area, in accordance with the orientation of the bathtub (see the area indicated by the letter "E"). No water drain muff should be left in the area indicated by the letter "B". External faucet application should be carried with a minimum distance of 100mm to the bathtub and in accordance with the bathtub placement. The axle distance between the hot and cold water inlet pipes should be adjusted in accordance with the technical drawing of the faucet. (See the Technical Data Sheet for the technical scheme).

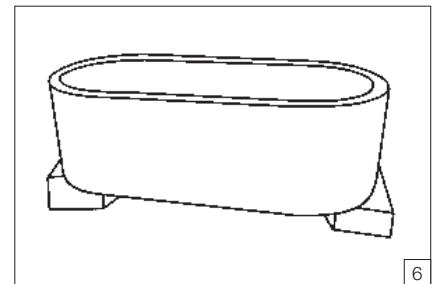
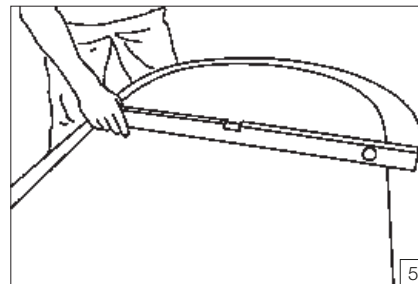
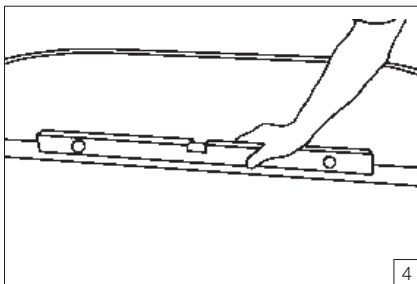

4-5 The bathtub is taken into level using a scale at the installation area.

6- For the infrastructure installation, the bathtub is placed on bearing supports at the installation area.

Caution: During the infrastructure installation, the bathtub should not be tilted sideways and no weight should be placed on its side panels.

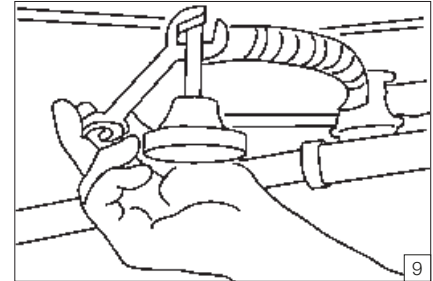
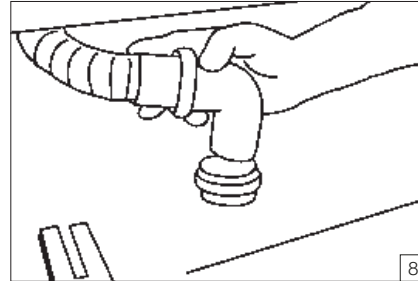
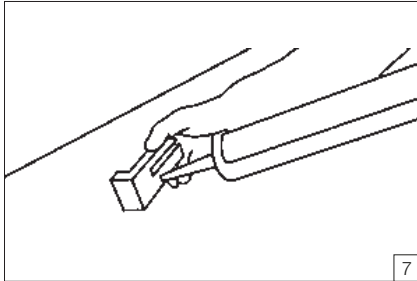

7- The parts of the bathtub's monobloc sides that touch the floor should be marked. The panel supporting brackets should be pulled inside at the thickness of the acrylic and they should be fixed to the floor with silicone. Accordingly, movement of the bathtub on the floor is prevented.

8- The siphon drain pipe connection and also the electrical connection (if the product is hydromassage) of the bathtub should be made.

9- Tighten the leg set nuts.

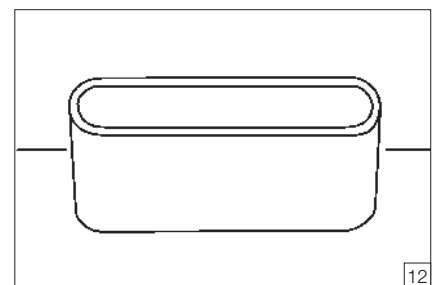
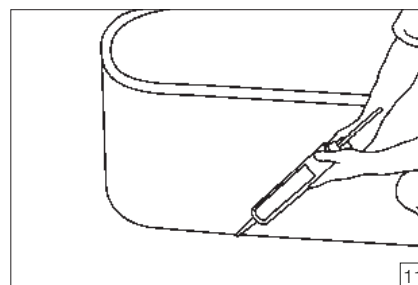
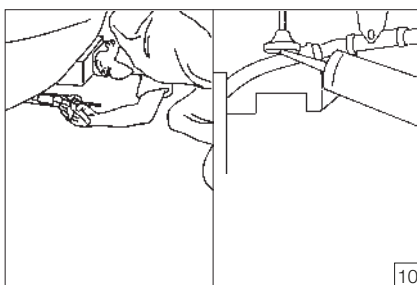

10- Apply silicone on the bathtub legs' parts which contact the floor.



11- When the infrastructure installation is completed the taken down from the bearing supports. When deemed necessary apply silicone to several points between the bathtub panel and the floor and complete the installation

12- The installation of the monobloc bathtub is completed. Any remaining protective folio on the bathtub should be removed only after the bathtub installation and any other construction works in the bathroom are finished.

MESSAGE SYSTEMS IMPLEMENTED IN VİTRA BATHTUBS

- If your VitrA bathtub without massage functionality is a model which is suitable for the implementation of a hydro massage system you can convert it into a massage bathtub and enjoy the pleasure of hydro massages.
- You can have a suitable massage system installed to your VitrA plain bathtub you have purchased and are using anytime you want.
- Which massage systems can be installed to the VitrA bathtubs are detailed in the table below. You can obtain detailed information about massage systems from VitrA Bathtub Authorized Sellers.

Hydro Massage Systems – Technical Features

		Duo Maxi	Duo Soft	Aqua Maxi
				
System type		electronic	electronic	electronic
Control panel/button type		digital control panel (exquisite)	electronic control panel	electronic controller
No. of jets*	Hava jeti	10	10	–
	Su jeti	18 mikro	6	18 mikro
Air controller		4	2	4
Director		–	–	–
Control panel / button functions	Continuous water massage	✓	✓	✓
	Intermittent water massage	✓	✓	✓
	Automatic water massage intensity setting	✓	–	–
	Manual water massage intensity setting	✓	–	–
	Continuous air massage	✓	✓	–
	Intermittent air massage	✓	✓	–
	Automatic air massage intensity setting	✓	–	–
	Manual air massage intensity setting	✓	✓	–
	Continuous light (optional)	✓	✓	✓
	Intermittent light (optional)	✓	✓	✓
Automatic disinfection program		✓	–	–
Visible parts		chrome coating over brass	chrome coating over brass	chrome coating over brass
Light application		2 halogen lamps (optional)	2 halogen lamps (optional)	1 halogen lamps (optional)
After-use drying function		✓	✓	–
Average weight (kg)		40	30	26
Input Power (kW)	Pump	0.8	0.8	0.8
	Blower	1.05	1.05	–
Voltage (Volts)		220-230	220-230	220-230
Current (Amps)		16	16	10



★ The number of jets in the massage systems may vary according to the selected bathtub model.

★ For the massage system and bathtub model information see the “Hydromassage - Bathtub Suitability Table” in the Price List.

Önemli Not:

- The specified number of jets and air controllers for the massage system may vary according to the bathtub model due to technical reasons.
- You can find more detailed info regarding the subject at www.vitra.com.tr or using our consultation line 0800 211 70 00 and 0532 755 75 00
- If your product is a product that is suitable for hydromassage system implementation, you can find more detailed info in the schemes in the technical data sheet.

Hydro Massage Systems – Technical Features

		Air Relax	Aqua Soft	Aqua Soft Easy
				
System type		electronic	electronic	pneumatic
Control panel/button type		electronic control panel	electronic control panel	–
No. of jets*	Air jets	24	6	–
	Water jets	–	2	6
Air controller		–	–	1
Director		–	–	–
Control panel / button functions	Continuous water massage	–	✓	✓
	Intermittent water massage	–	✓	–
	Automatic water massage intensity setting	–	–	–
	Manual water massage intensity setting	–	–	–
	Continuous air massage	✓	–	–
	Intermittent air massage	–	–	–
	Automatic air massage intensity setting	–	–	–
	Manual air massage intensity setting	–	–	–
	Continuous light (optional)	✓	–	–
	Intermittent light (optional)	–	–	–
	Automatic disinfection program	–	–	–
Visible parts		chrome coating over brass	chrome coating over brass	ABS or chrome coating
Light application		2 halogen lamps (optional)	–	–
After-use drying function		–	–	–
Average weight (kg)		12	21	18
Input Power (kW)	Pump	–	0.8	0.8
	Blower	0.04	–	–
Voltage (Volts)		220-230	220-230	220-230
Current (Amps)		10	10	10

★ The number of jets in the massage systems may vary according to the selected bathtub model.

★ For the massage system and bathtub model information see the “Hydromassage - Bathtub Suitability Table” in the Price List.

MAINTENANCE OF BATHTUBS

MATTERS THAT REQUIRE ATTENTION!

- Acrylic is durable against acids and alkalines. However do not let organic solutions used in dry cleaning, paint remover substances, acetone or other solvents to your compact system.
- Keep lighted cigarettes away from the product.
- If the construction activities in the bath will continue after installation, do not remove the folio layer on the product and apply full protection to the product.

POSSIBLE PROBLEMS AND THEIR SOLUTIONS

Problem	Solution
<ul style="list-style-type: none">• The surface of the product is dull and/or scratched.	<ul style="list-style-type: none">• If your product is new, the protective film layer on it might not have been removed.• If dullness/scratches occur after a certain period of use, you may be using incorrect cleaning materials. See the 'Cleaning' section.
<ul style="list-style-type: none">• My bathtub stretches	<ul style="list-style-type: none">• Check if the Wall hangers are installed on the wall or not.• The wall hangers must be used in order to preserve the rigidity of the bathtub
<ul style="list-style-type: none">• Water leakage under the bathtub	<ul style="list-style-type: none">• Check the silicone application between the bathtub and the wall
<ul style="list-style-type: none">• The siphon drain of my bathtub clogs frequently.	<ul style="list-style-type: none">• Hair, soap, etc. could clog the siphon in time. Clean the siphon drain with a drain opener from time to time.
<ul style="list-style-type: none">• The siphon plug does not open even though the control handle is forced.	<ul style="list-style-type: none">• If you force the control handle too much the siphon wire could break. Therefore height adjustment should be made by turning the plug counter clock wise without forcing the handle.

If your problems persist please contact the nearest VitrA-Artema Authorized Service.

CLEANING THE ACRYLIC BATHTUBS

- Right after you use your bathtub, clean it with a liquid bath cleaner or a decalcifier and a soft cloth and warm water. Otherwise unwanted soap products, dirt and hard water will create a thin layer on the acrylic surface and it will become more difficult to clean.
- Do not use hydrochloric acid, abrasives, powdered detergents and cream detergents that contain powders, soft soap and hard/scratching cleaning sponges for cleaning your bathtub.

Note: When products with cabins, particularly patterned products are concerned, clean the glasses with a soft cloth and warm water. Do not use hydrochloric acid, abrasive / powdered / liquid detergents soft soap or hard/scratching cleaning sponges. Do not let organic dilutions, paint removers, acetone and other solvents contact the glass.

DEFECTS NOT COVERED UNDER WARRANTY

Shipping, Storage

- 1- Deformations to the product surface during the shipping and transportation carried out after the products are delivered or any breakages which may occur as the result of impacts,
 - 2- Deformations and breakages on the surfaces of products which remain at the construction site for a long time without protection,
 - 3- Damage to the product as the result of effects of the water and/or humidity in the environment during the storage and use of the products,
 - 4- Products damaged by each other due to stacking on top of each other during storage,
- shall be treated out of scope of the warranty.

Installation

- 1- Failures which occur as the result of incorrect installation, maintenance, repairs and disassembly performed by unauthorized persons,
 - 2- Factors which impact the installation of the product, resulting from the wall or floor not being level, or hot-cold water, waste water drain installments not complying with the infrastructure measurements given in the technical data sheets.
 - 3- Surface deformations and failures occurring due to small particles in the plumbing (stone, sand, gravel, etc.) and encrustation,
 - 4- Failures occurring due to the wall structure being different than the specified types.
 - 5- Failures occurring due to the utility system pressure not being at the required value.
 - 6- Failures occurring due to faulty electrical installment (such as unearthed cable, voltage fluctuations)
 - 7- Failures occurring where the holes required for on-bathtub armature application are drilled by people other than the manufacturer or the authorized services.
 - 8- Failures occurring due to not establishing the ventilation valve and drain which must be established in built-in applications.
- shall be treated out of scope of the warranty.

Use, Cleaning and Maintenance

- 1- Deformations and failures on the surface, electronic parts due to practices other than the use functions specified in the User Guide,
 - 2- Deformations and dullness occurring on the surface of products wiped with cleaning substances containing acid and cleaning substances containing abrasive powders,
 - 3- Deformations and dullness occurring on the surface of products wiped with rough cleaning substances (wire sponge, hardened sponge, etc.),
 - 4- Deformations that welding electrode sparks, flammable substances during alterations made in the bathroom spaces and cigarettes may cause on the product surface,
 - 5- Failures occurring due to use of parts other than original spare parts,
- shall be treated out of scope of the warranty.

VitrA

 Eczacıbaşı

Eczacıbaşı Yapı Gereçleri San. Ve Tic. A.Ş.

Reserves the right to make any technical changes on the product without prior notice

