

AZTECA

S205-REG1W1D/21/9

A	B	C	D	
1	S205 028	2071	396	3/6
2	S205 137	2043	390	2/6
3	S205 138	2043	390	2/6
4	S205 139	2043	364	2/6
5	S205 221	900	390	1/6
6	S205 222	900	390	1/6
7	S205 306	474	360	1/6
8	S205 716	809	496	3/6
9	S205 314	475	360	1/6
10	S205 315	374	360	1/6
11	S205 553	919	480	5/6
12	S205 583	370	100	3/6
13	S205 586	270	100	3/6
14	S205 308	469	340	4/6
15	S205 718	403	496	3/6
16	S205 915	2053	388	2/6
17	S205 958	2053	244	2/6
18	S205 958	2053	244	2/6
19	Lh 2035	2035	14	2/6

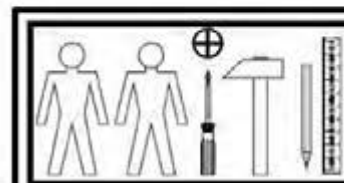
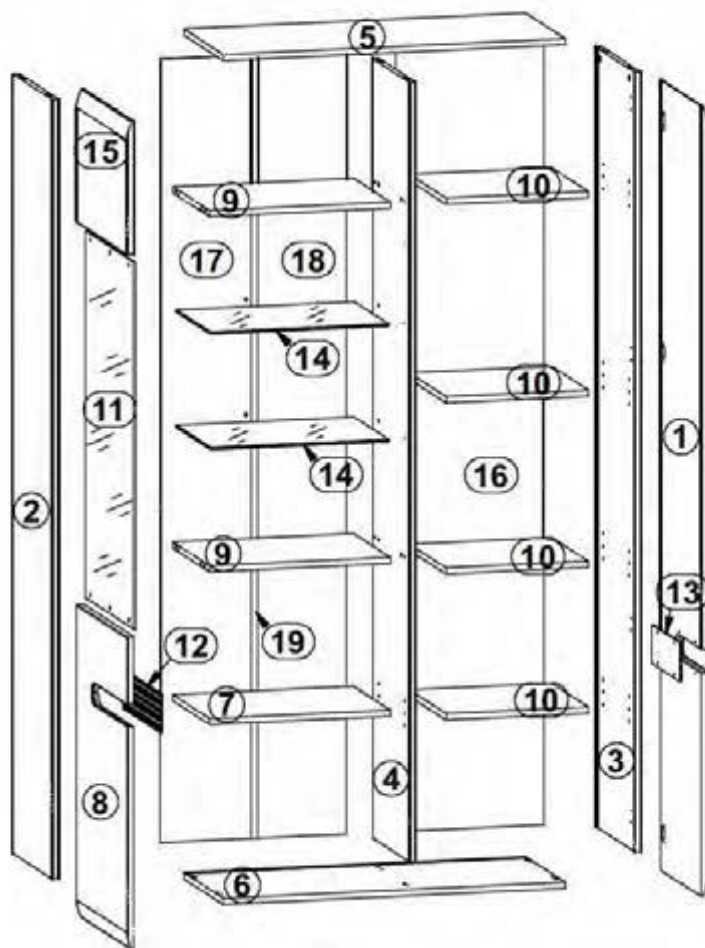
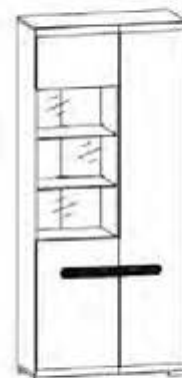

8x a102	8x b59	20x d1	8x d33	6x e1	6x e47	20x f1	2x k84	3x k85
12x l1	22x l2	12x n108	2x o43l8	1x o43l6	6x o54	15x p38	16x p51	12x p55
6x p6	14x r1	14x r42	14x s2	1x z1	1x n26l1	40x s4		

1 

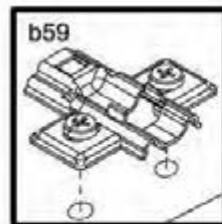
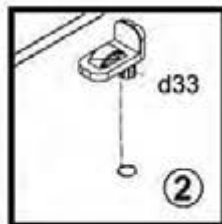
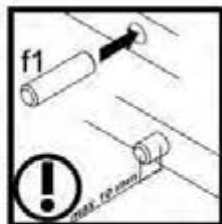
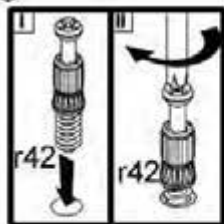
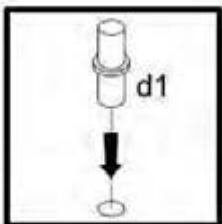
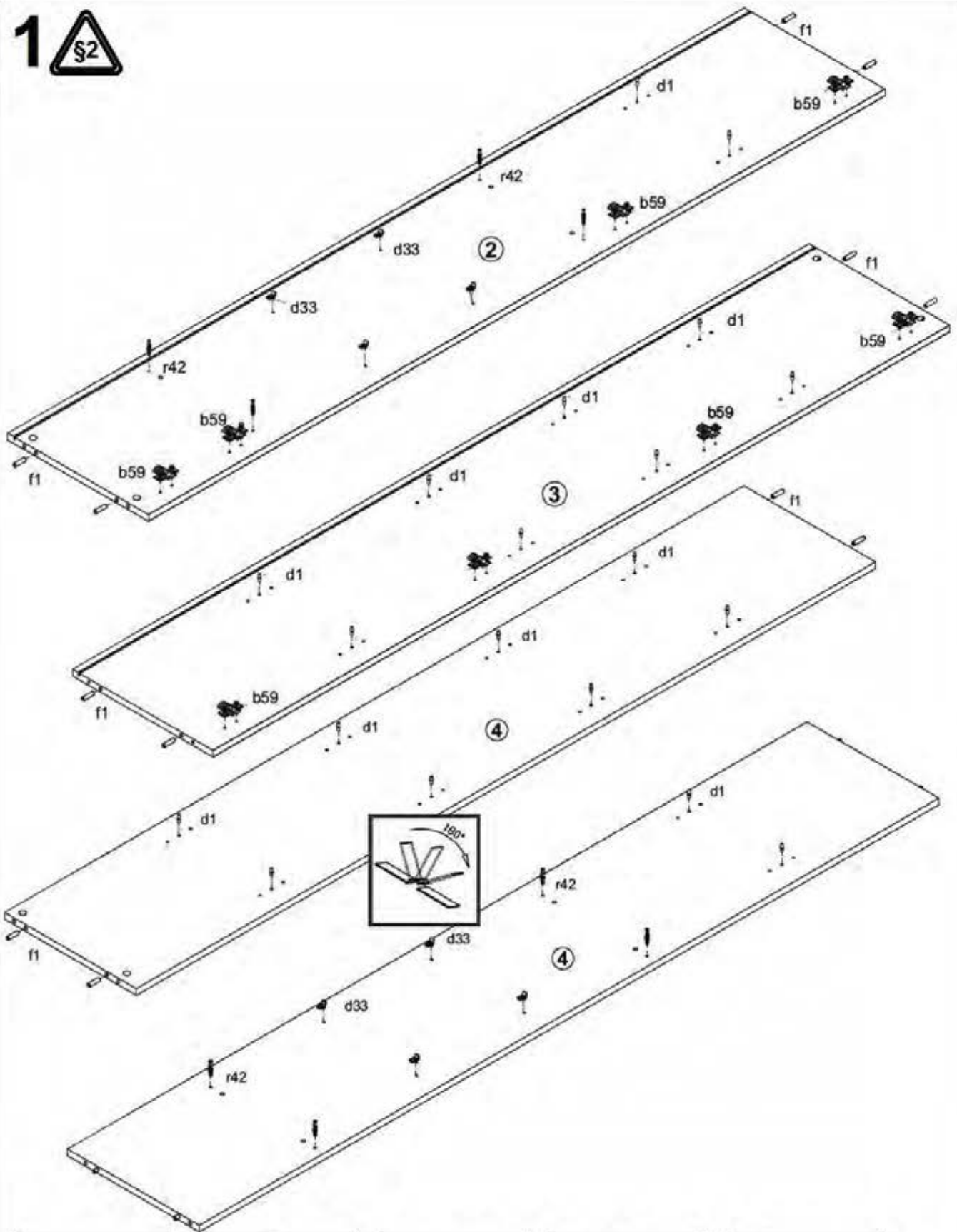

3

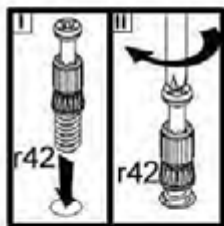
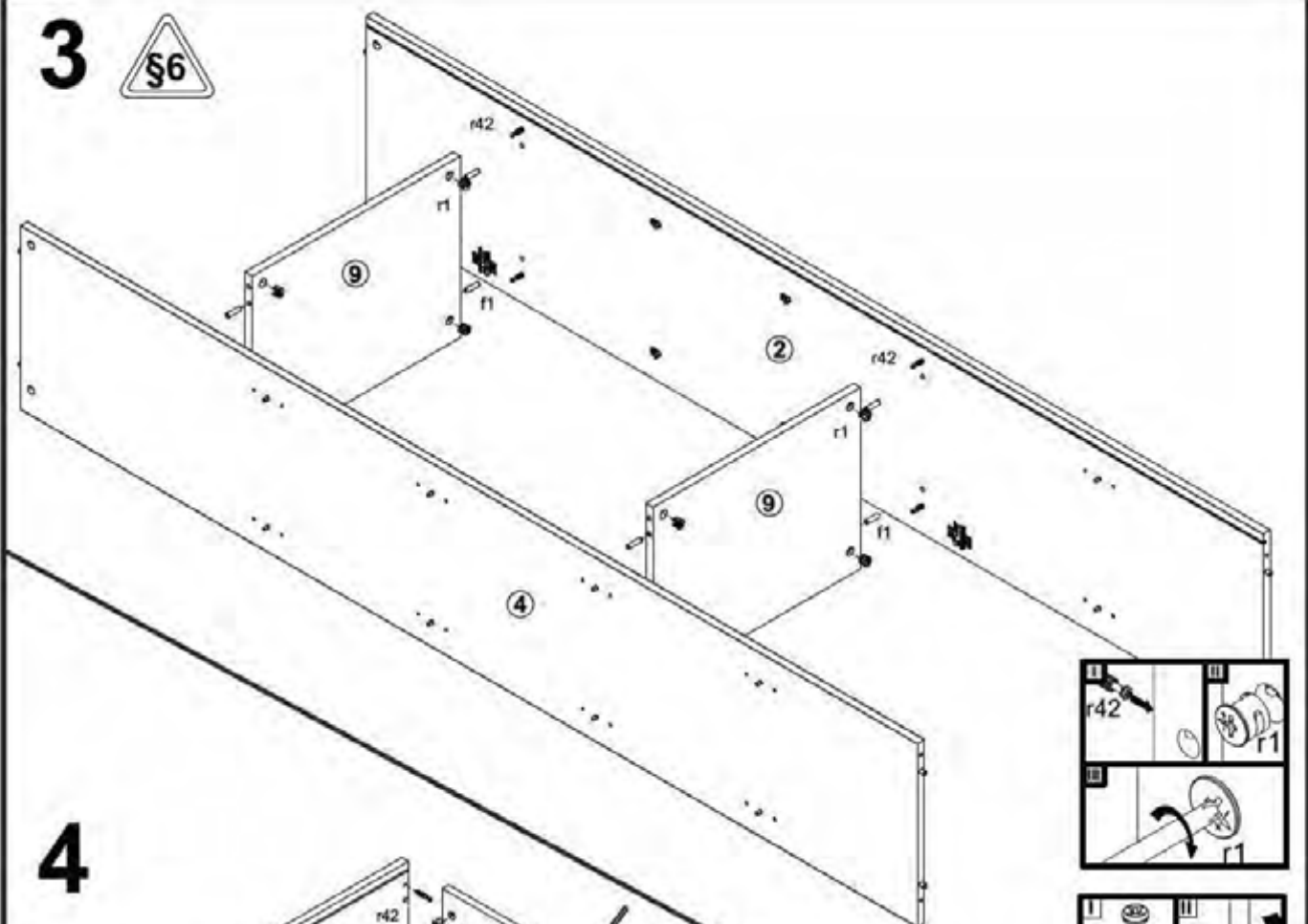

4

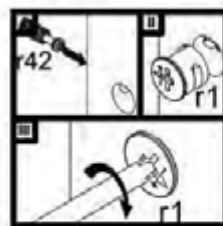
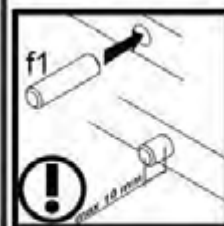
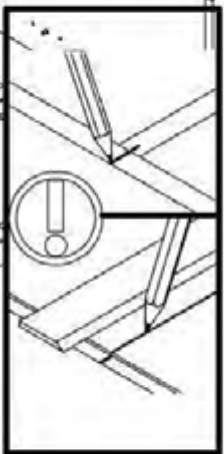
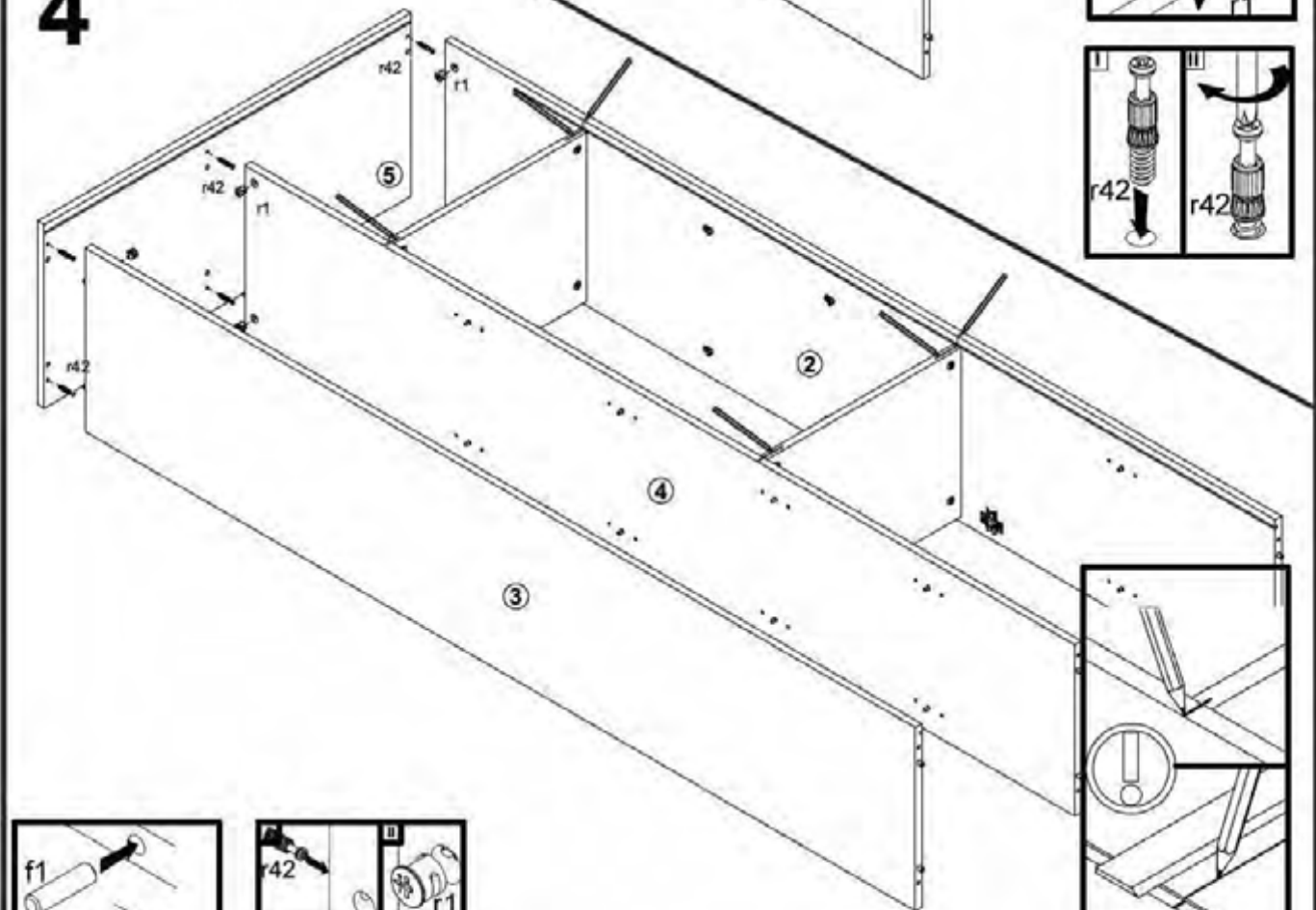

5

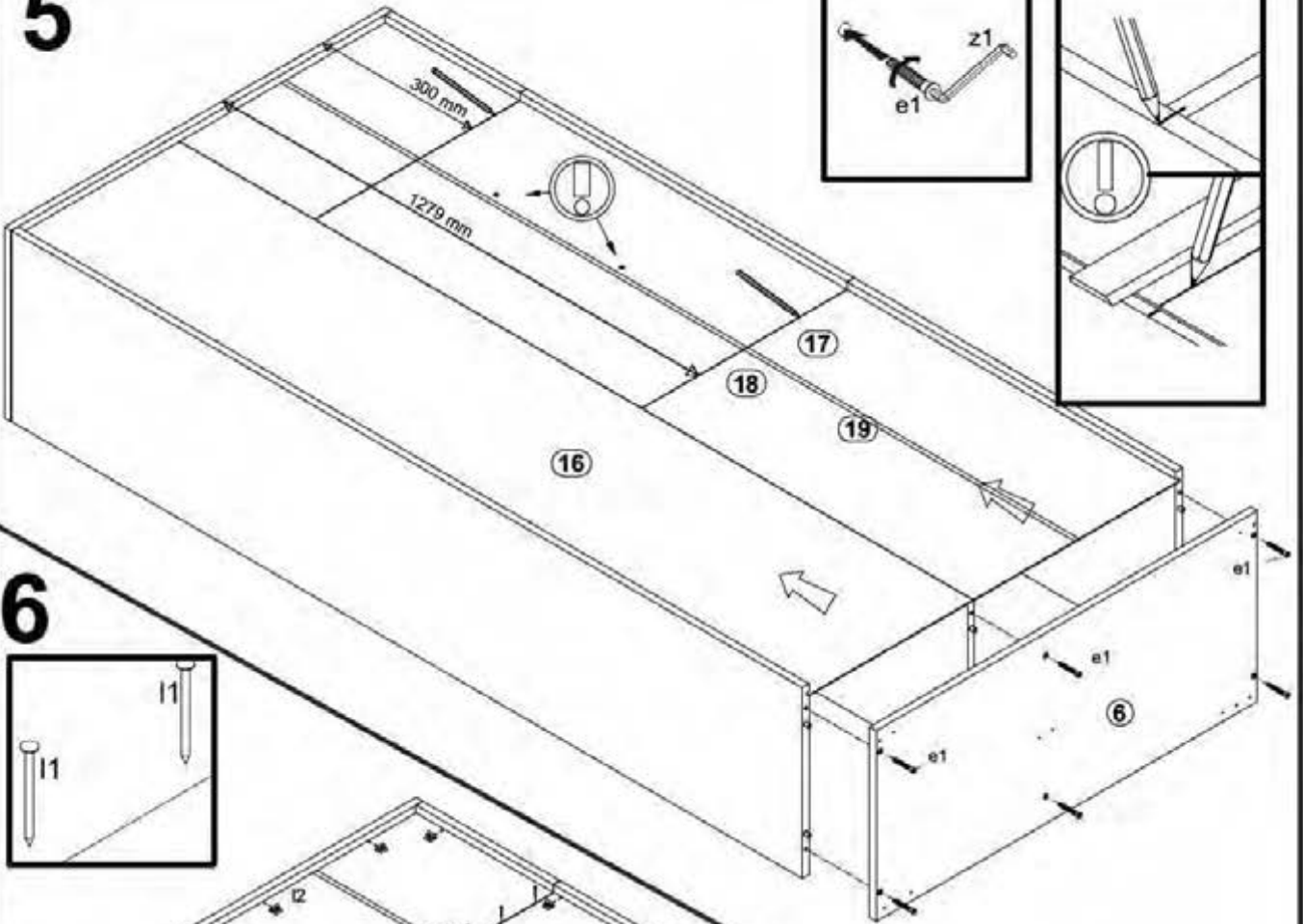

6

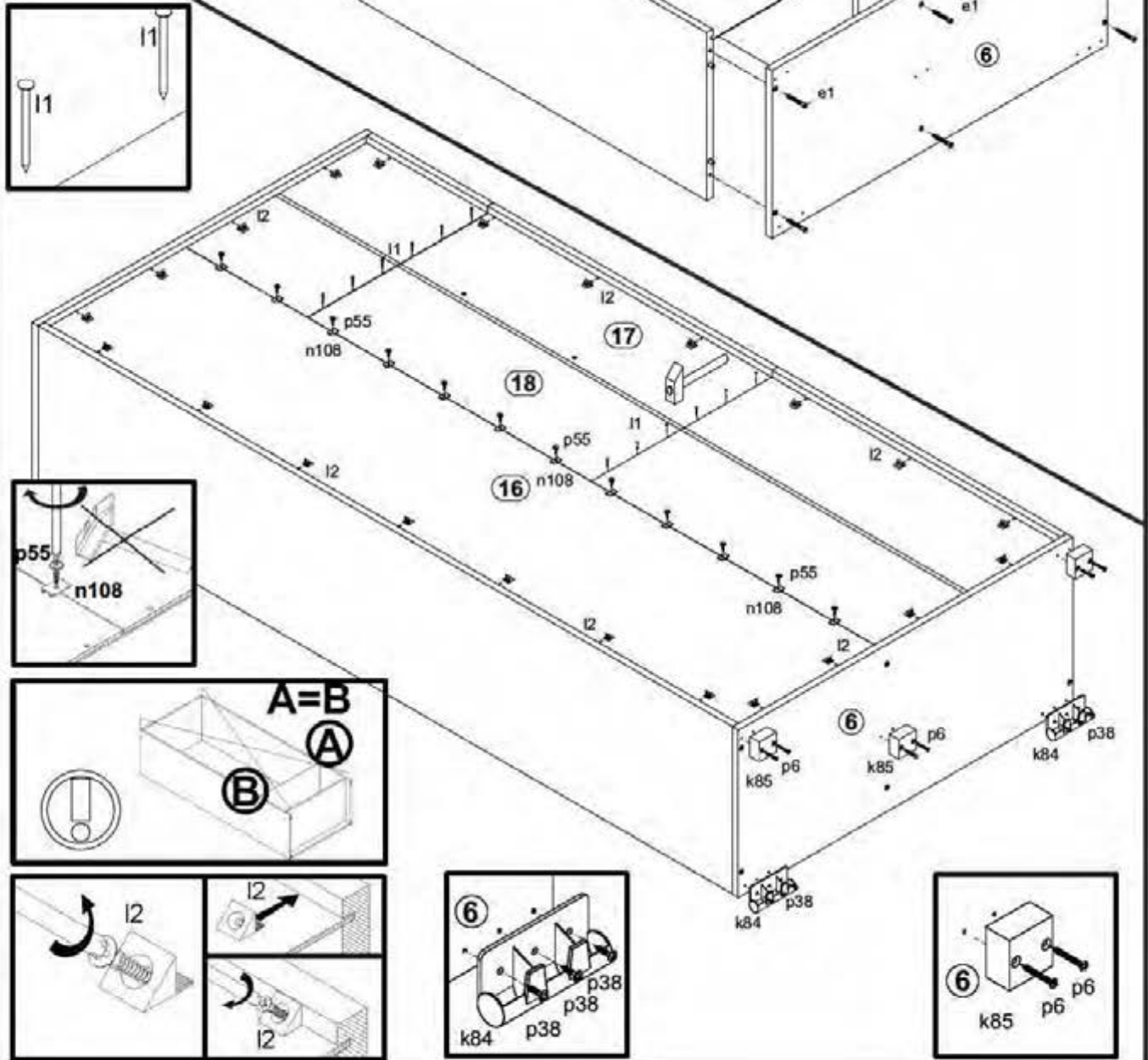

7

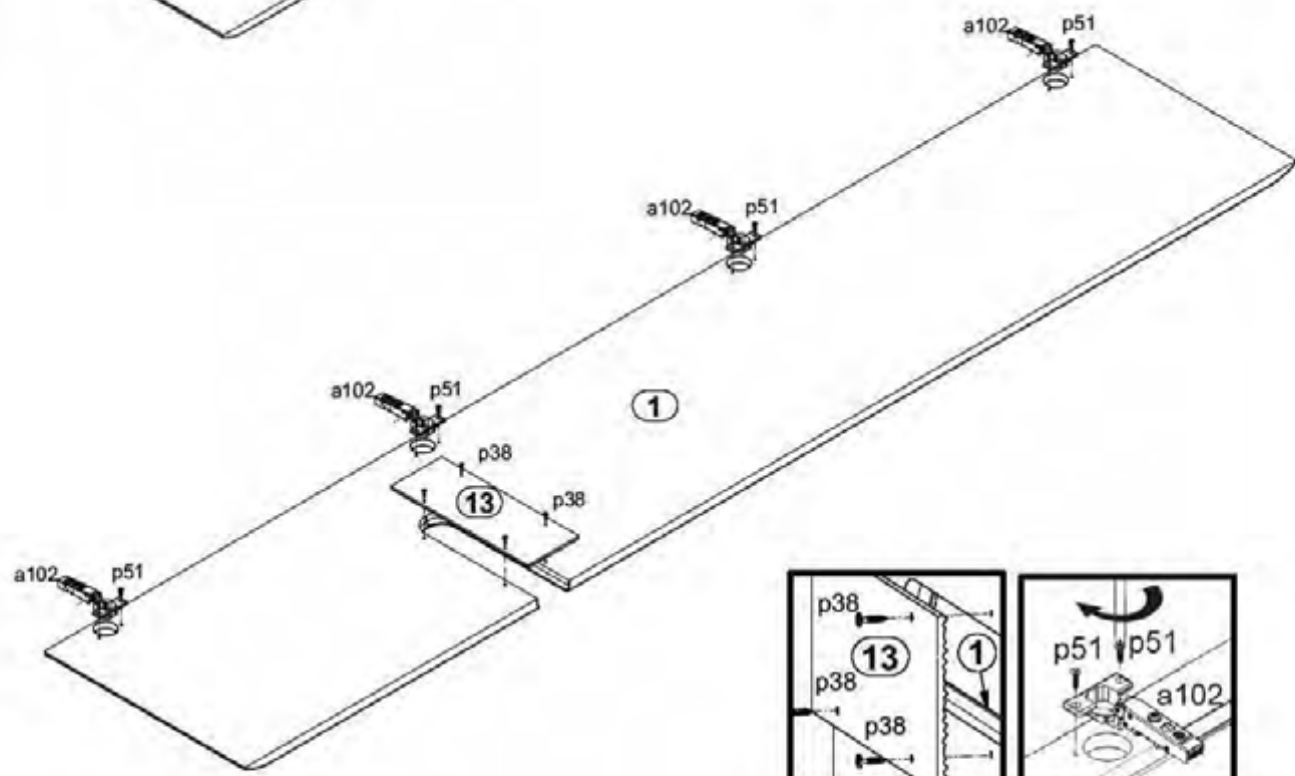
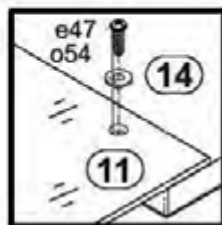
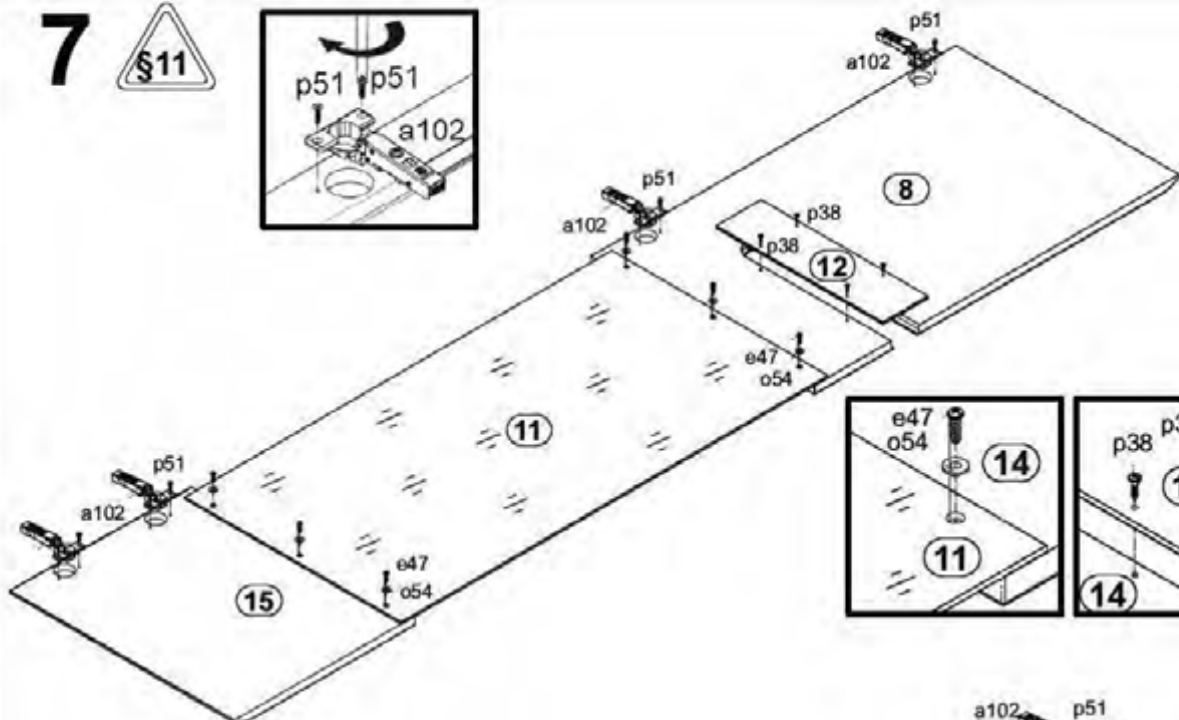
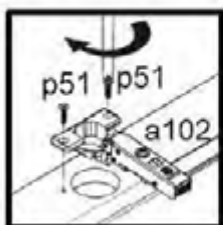

8

