

European Community Design Registration RCD 000929971

TORK[®]

Liquid Soap
Dispenser
Arm Lever

S1

Elevation
Design

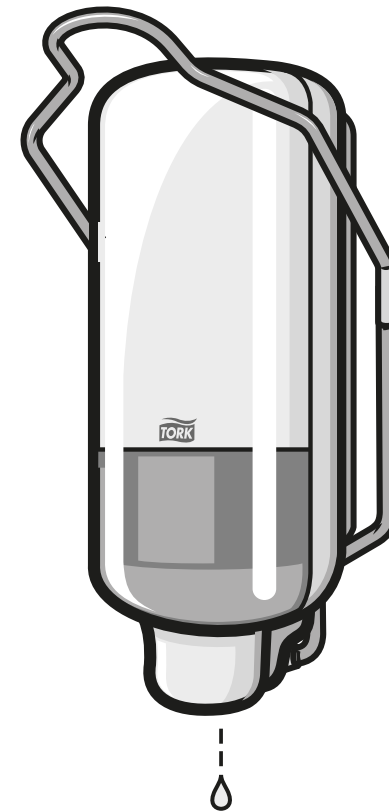

 **essity**

Manufactured by Essity Hygiene and Health AB
SE-40503 Göteborg, Sweden
Visiting address: Mölndals Bro 2, Mölndal
www.essity.com, www.torkglobal.com
Made in Hungary
Patents/Brevets/Patentes: www.essity.com/patents

www.torkglobal.com

TORK[®]

TM.by
ONLINE STORE

<https://tm.by>
Интернет-магазин TM.by

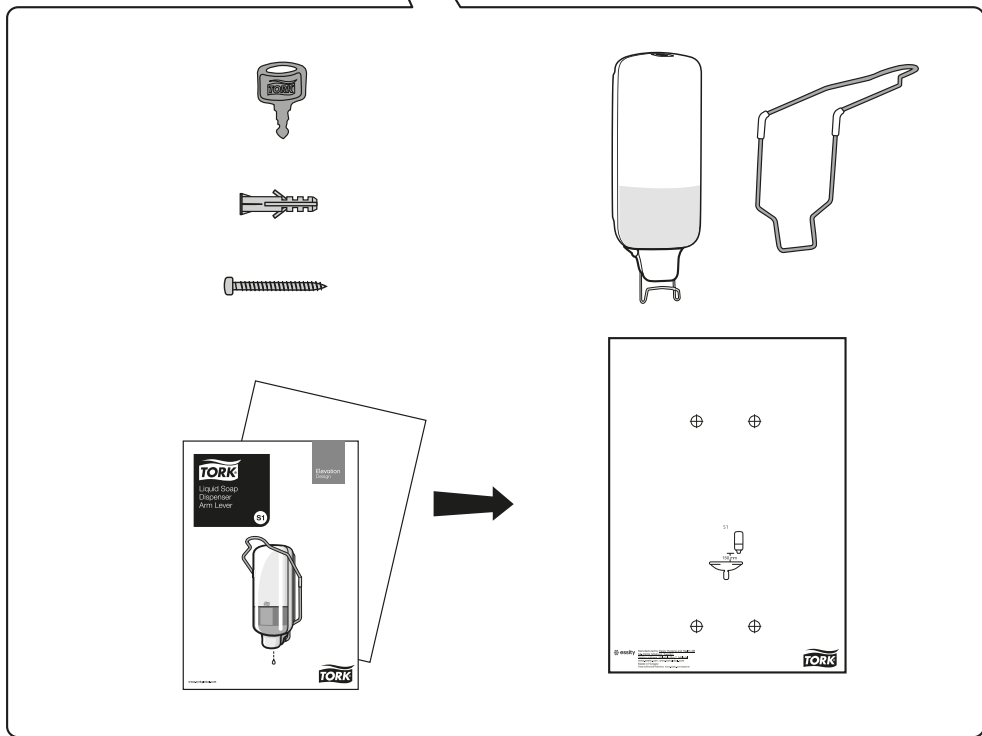
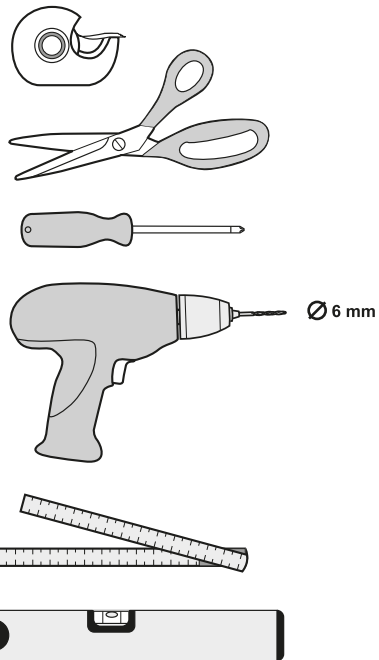
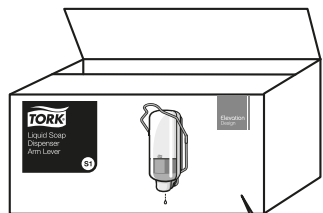

1

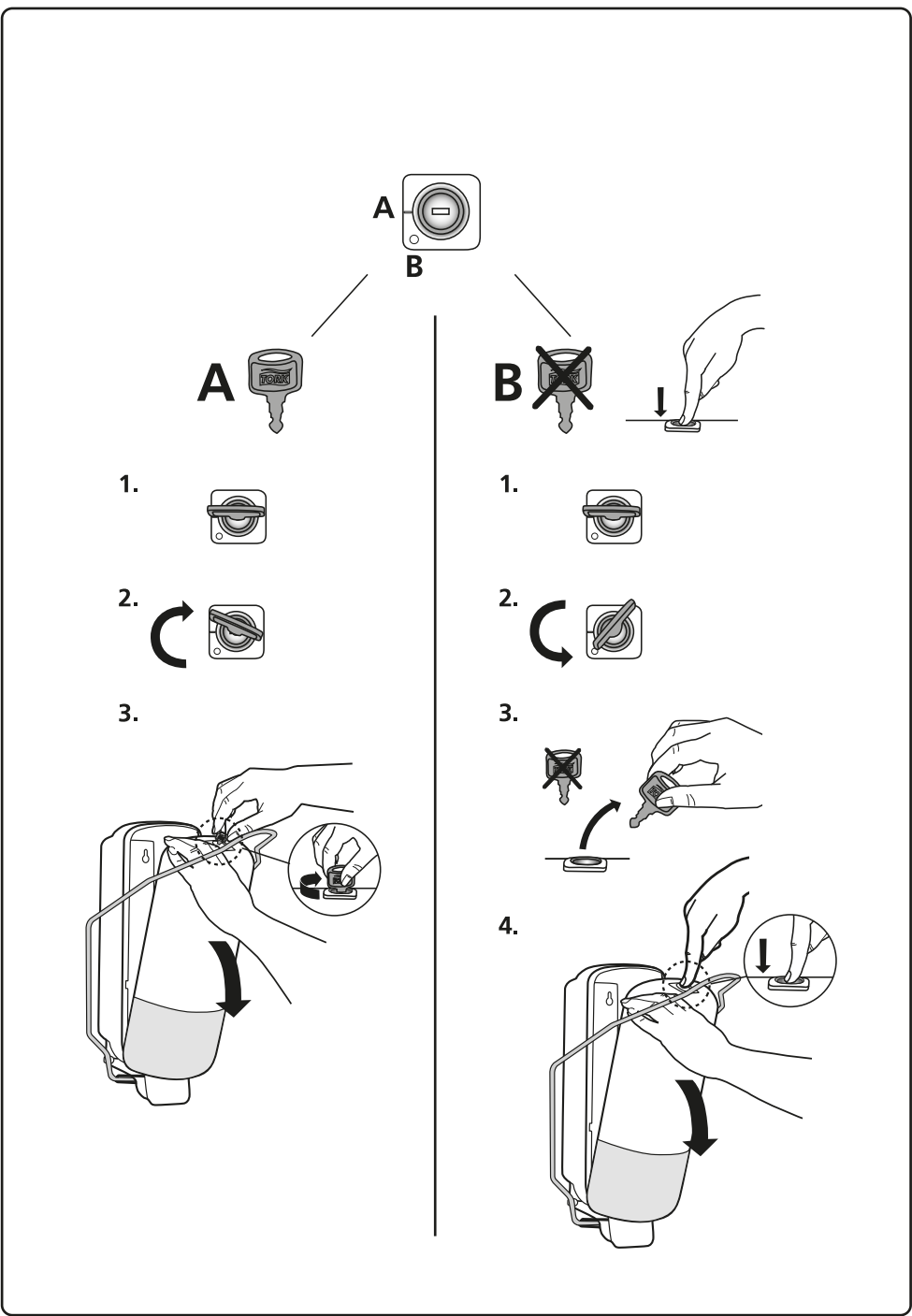

6

3.

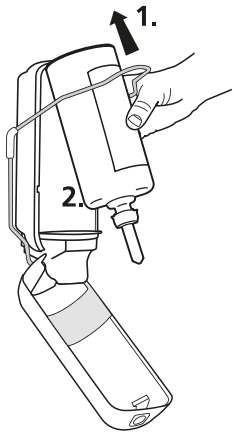

4.

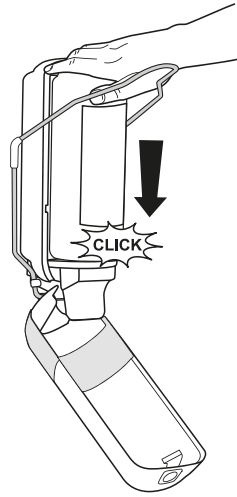

5.

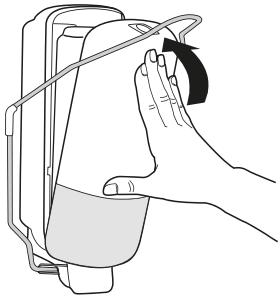

6.

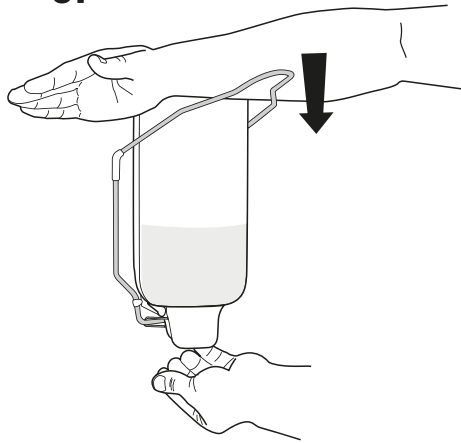

1.

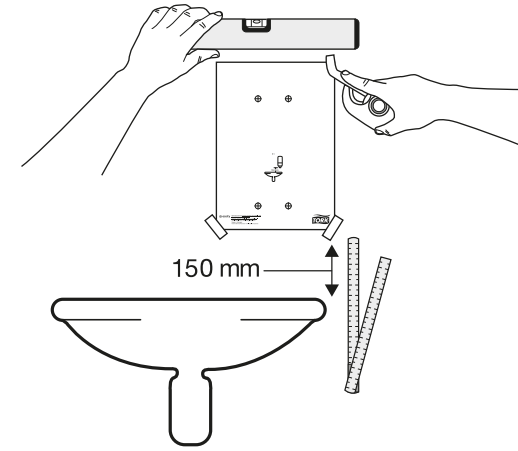

2.

