

Dell P2222H/P2422H/P2722H

Monitor

User's Guide

Monitor Model: P2222H/P2422H/P2722H
Regulatory Model: P2222Hb/P2222Ht/P2422Hb/P2422Hc/P2722Hb/P2722Ht



 **NOTE:** A NOTE indicates important information that helps you make better use of your computer.

 **CAUTION:** A CAUTION indicates potential damage to hardware or loss of data if instructions are not followed.

 **WARNING:** A WARNING indicates a potential for property damage, personal injury, or death.

Copyright © 2021 Dell Inc. or its subsidiaries. All rights reserved. Dell, EMC, and other trademarks are trademarks of Dell Inc. or its subsidiaries. Other trademarks may be trademarks of their respective owners.

2021 – 05

Rev. A00



2 |

Contents

Safety instructions	6
About your monitor	7
Package contents	7
Product features	9
Identifying parts and controls	10
Front view	10
Back view	11
Bottom view	12
Monitor specifications	13
Resolution specifications	19
Supported video modes	19
Preset display modes	20
Physical characteristics	23
Environmental characteristics	26
Pin assignments	27
VGA connector	27
DisplayPort connector	28
HDMI connector	29
Universal Serial Bus (USB) interface	30
Plug and play capability	31
LCD monitor quality and pixel policy	32
Maintenance guidelines	32
Cleaning your monitor	32



Setting up the monitor	33
Connecting the stand	33
Connecting your monitor	36
Connecting the DisplayPort and USB cable	36
Connecting the HDMI cable (optional)	37
Connecting the VGA cable (optional).	37
Organizing cables	38
Removing the stand	39
Wall mounting (optional)	40
Operating your monitor	41
Power on the monitor	41
Using the joystick control	41
Using the On-Screen Display (OSD) menu	42
Accessing the Menu Launcher.	42
Using the navigation keys.	43
Accessing the OSD menu	44
Menu and Power button lock	55
OSD warning messages	58
Setting the maximum resolution	61
Using the tilt, swivel, and vertical extension	62
Tilt, swivel	62
Vertical Extension	62
Rotating the monitor	63
Rotate clockwise	63
Rotate counterclockwise	64
Adjusting the rotation display settings of your system	65



Troubleshooting 66

- Self-Test 66
- Built-in diagnostics 68
- Common problems 70
- Product-specific problems 73
- Universal Serial Bus (USB) specific problems 73

Appendix. 75

- FCC notices (U.S. Only) and other regulatory information 75
- Contacting Dell. 75
- EU product database for energy label and product information sheet 75



Safety instructions

Use the following safety guidelines to protect your monitor from potential damage and to ensure your personal safety. Unless otherwise noted, each procedure included in this document assumes that you have read the safety information that shipped with your monitor.

 **Before using the monitor, read the safety information that is shipped with your monitor and also printed on the product. Keep the documentation at a secure location for future reference.**

 **CAUTION: Use of controls, adjustments, or procedures other than those specified in this documentation may result in exposure to shock, electrical hazards, and/or mechanical hazards.**

- Place the monitor on a solid surface and handle it carefully. The screen is fragile and can be damaged if dropped or hit with a sharp object.
- Always be sure that your monitor is electrically rated to operate with the AC power available in your location.
- Keep the monitor in room temperature. Excessive cold or hot conditions can have an adverse effect on the liquid crystal of the display.
- Connect the power cable from the monitor to a wall outlet that is near and accessible. See [Connecting your monitor](#).
- Do not place and use the monitor on a wet surface or near water.
- Do not subject the monitor to severe vibration or high impact conditions. For example, do not place the monitor inside a car trunk.
- Unplug the monitor when it is going to be left unused for an extended period of time.
- To avoid electric shock, do not attempt to remove any cover or touch the inside of the monitor.
- Read these instructions carefully. Keep this document for future reference. Follow all warnings and instructions marked on product.
- Excessive sound pressure from earphones and headphones can cause hearing loss. Adjustment of the equalizer to maximum increases the earphones and headphones output voltage and therefore the sound pressure level.
- The equipment can be installed on wall or ceiling mounting in horizontal position.







About your monitor

Package contents

Your monitor ships with the components shown in the table below. If any component is missing, contact Dell. For more information, see [Contacting Dell](#).

NOTE: Some items may be optional and may not ship with your monitor. Some features or media may not be available in certain countries.

	Monitor
	Stand riser
	Stand base
	Power cable (varies by country)



	<p>DisplayPort 1.2 cable</p>
	<p>VGA cable (Japan only)</p>
	<p>HDMI 1.4 cable (Brazil only)</p>
	<p>USB 3.0 upstream cable (enables the USB ports on the monitor)</p>
	<ul style="list-style-type: none"> • Quick Setup Guide • Safety, Environmental and Regulatory Information



Product features

The Dell P2222H/P2422H/P2722H monitor has an active matrix, Thin-Film Transistor (TFT), Liquid Crystal Display (LCD), and LED backlight. The monitor features include:

- P2222H: 54.61 cm (21.5 in.) viewable area display (measured diagonally).
- P2422H: 60.47 cm (23.8 in.) viewable area display (measured diagonally).
- P2722H: 68.60 cm (27 in.) viewable area display (measured diagonally).
- 1920 x 1080 resolution, with full-screen support for lower resolutions.
- Color gamut of 99% sRGB.
- Digital connectivity with DisplayPort and HDMI.
- Equipped with 1 USB upstream port and 4 SuperSpeed USB 5 Gbps (USB3.2 Gen 1).
- Plug and play capability if supported by your computer.
- On-Screen Display (OSD) adjustments for ease of setup and screen optimization.
- Power and joystick buttons lock.
- Removable stand and Video Electronics Standards Association (VESA™) 100 mm mounting holes for flexible mounting solutions.
- Tilt, swivel, height, and rotate adjustment capabilities.
- Security-lock slot.
- Stand lock.
- ≤0.3 W standby power when in Standby Mode.
- Supports Dell Display Manager.
- Optimize eye comfort with a flicker-free screen and low blue light feature.
- The monitor use Low Blue Light panel and compliance with TUV Rheinland (Hardware Solution) at factory reset/default setting model (Preset mode: Standard).

⚠ WARNING: The possible long-term effects of blue light emission from the monitor may cause damage to the eyes, including eye fatigue, digital eye strain, and so on. ComfortView Plus feature is designed to reduce the amount of blue light emitted from the monitor to optimize eye comfort.



Identifying parts and controls

Front view

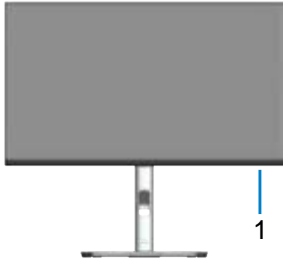

Label	Description
1	Power LED indicator Solid white light indicates that the monitor is turned on and functioning normally. Blinking white light indicates that the monitor is in Standby Mode.



Back view



Back View with monitor stand

Label	Description	Use
1	VESA mounting holes (100 mm x 100 mm - behind attached VESA Cover)	Wall-mount the monitor using VESA-compatible wall mount kit (100 mm x 100 mm).
2	Regulatory label	Lists the regulatory approvals.
3	Stand release button	Releases the stand from the monitor.
4	Barcode, serial number, and Service Tag label	Refer to this label if you need to contact Dell for technical support.
5	Power On/Off button	To turn the monitor on or off.
6	Joystick	Use to control the OSD menu. (For more Information, see Operating your monitor)
7	Cable-management slot	Use to organize cables by routing them through the slot.



Bottom view



Bottom view without monitor stand

Label	Description	Use
1	Security-lock slot	Secure your monitor using a security lock (purchased separately) to prevent unauthorized movement of your monitor.
2	Power connector	Connect the power cable (shipped with your monitor).
3	HDMI port	Connect to your computer using a HDMI cable (shipped with your monitor, for Brazil only).
4	Stand lock	To lock the stand to the monitor using a M3 x 6 mm screw (screw not included).
5	DisplayPort	Connect to your computer using a DisplayPort cable (shipped with your monitor).
6	VGA connector	Connect your computer with VGA cable (shipped with your monitor, for Japan only).
7	USB 3.0 upstream port	Connect the USB cable (shipped with your monitor) from this port to your computer to enable the USB ports on your monitor.
8	SuperSpeed USB 5 Gbps (USB3.2 Gen 1) Type-A downstream port (4)	Connect your USB devices. *  NOTE: To use this port, you must connect the USB upstream cable (shipped with your monitor) between the monitor and the computer.

*To avoid signal interference, when a wireless USB device has been connected to a USB downstream port, it is NOT recommended to connect any other USB devices to the adjacent port(s).



Monitor specifications

Model	P2222H
Screen type	Active matrix-TFT LCD
Panel type	In-Plane Switching Technology
Aspect ratio	16:9
Viewable image	
Diagonal	546.10 mm (21.5 in.)
Horizontal, Active Area	476.06 mm (18.74 in.)
Vertical, Active Area	267.79 mm (10.54 in.)
Area	127484.11 mm ² (197.60 in. ²)
Native resolution and refresh rate	1920 x 1080 at 60 Hz
Pixel pitch	0.2480 mm x 0.2480 mm
Pixel per inch (PPI)	102
Viewing angle	
Horizontal	178° (typical)
Vertical	178° (typical)
Luminance output	250 cd/m ² (typical)
Contrast ratio	1000 to 1 (typical)
Display screen coating	Anti-glare treatment of the front polarizer (3H) hard coating
Backlight	LED edgelight system
Response time	5 ms (Fast mode) 8 ms (Normal mode)
Color depth	16.7 million colors (6bit+FRC)
Color gamut	sRGB 99%
Connectivity	1 x HDMI 1.4 (HDCP 1.4) 1 x DisplayPort 1.2 (HDCP 1.4) 1 x VGA 1 x USB 3.0 upstream 4 x SuperSpeed USB 5 Gbps (USB3.2 Gen 1)



Bezel width (edge of monitor to active area)	
Top	5.60 mm
Left/Right	5.60 mm
Bottom	16.60 mm
Adjustability	
Height adjustable stand	150 mm
Tilt	-5° to 21°
Swivel	-45° to 45°
Pivot	-90° to 90°
Cable management	Yes
Dell display manager compatibility	Easy Arrange and other key features
Security	Security-lock slot (cable lock optional purchase)



Model	P2422H
Screen type	Active matrix-TFT LCD
Panel type	In-Plane Switching Technology
Aspect ratio	16:9
Viewable image	
Diagonal	604.70 mm (23.8 in.)
Horizontal, Active Area	527.04 mm (20.75 in.)
Vertical, Active Area	296.46 mm (11.67 in.)
Area	156246.27 mm ² (242.15 in. ²)
Native resolution and refresh rate	1920 x 1080 at 60 Hz
Pixel pitch	0.2745 mm x 0.2745 mm
Pixel per inch (PPI)	93
Viewing angle	
Horizontal	178° (typical)
Vertical	178° (typical)
Luminance output	250 cd/m ² (typical)
Contrast ratio	1000 to 1 (typical)
Display screen coating	Anti-glare treatment of the front polarizer (3H) hard coating
Backlight	LED edgelight system
Response time	5 ms (Fast mode) 8 ms (Normal mode)
Color depth	16.7 million colors (6bit+FRC)
Color gamut	sRGB 99%



Connectivity	1 x HDMI 1.4 (HDCP 1.4) 1 x DisplayPort 1.2 (HDCP 1.4) 1 x VGA 1 x USB 3.0 upstream 4 x SuperSpeed USB 5 Gbps (USB3.2 Gen 1)
Bezel width (edge of monitor to active area)	
Top	5.38 mm
Left/Right	5.38 mm
Bottom	16.66 mm
Adjustability	
Height adjustable stand	150 mm
Tilt	-5° to 21°
Swivel	-45° to 45°
Pivot	-90° to 90°
Cable management	Yes
Dell display manager compatibility	Easy Arrange and other key features
Security	Security-lock slot (cable lock optional purchase)



Model	P2722H
Screen type	Active matrix-TFT LCD
Panel type	In-Plane Switching Technology
Aspect ratio	16:9
Viewable image	
Diagonal	686.00 mm (27 in.)
Horizontal, Active Area	597.89 mm (23.54 in.)
Vertical, Active Area	336.31 mm (13.24 in.)
Area	201076.39 mm ² (311.67 in. ²)
Native resolution and refresh rate	1920 x 1080 at 60 Hz
Pixel pitch	0.3114 mm x 0.3114 mm
Pixel per inch (PPI)	82
Viewing angle	
Horizontal	178° (typical)
Vertical	178° (typical)
Luminance output	300 cd/m ² (typical)
Contrast ratio	1000 to 1 (typical)
Display screen coating	Anti-glare treatment of the front polarizer (3H) hard coating
Backlight	LED edgelight system
Response time	5 ms (Fast mode) 8 ms (Normal mode)
Color depth	16.7 million colors (6bit+FRC)
Color gamut	sRGB 99%



Connectivity	1 x HDMI 1.4 (HDCP 1.4) 1 x DisplayPort 1.2 (HDCP 1.4) 1 x VGA 1 x USB 3.0 upstream 4 x SuperSpeed USB 5 Gbps (USB3.2 Gen 1)
Bezel width (edge of monitor to active area)	
Top	5.99 mm
Left/Right	6.01 mm
Bottom	17.29 mm
Adjustability	
Height adjustable stand	150 mm
Tilt	-5° to 21°
Swivel	-45° to 45°
Pivot	-90° to 90°
Cable management	Yes
Dell display manager compatibility	Easy Arrange and other key features
Security	Security-lock slot (cable lock optional purchase)



Resolution specifications

Model	P2222H/P2422H/P2722H
Horizontal scan range	30 kHz to 83 kHz (automatic)
Vertical scan range	56 Hz to 76 Hz (automatic)
Maximum preset resolution	1920 x 1080 at 60 Hz

Supported video modes

Model	P2222H/P2422H/P2722H
Video display capabilities (VGA/HDMI/DisplayPort)	480p, 576p, 720p, 1080i, 1080p



Preset display modes

Display Mode	Horizontal Frequency (kHz)	Vertical Frequency (Hz)	Pixel Clock (MHz)	Sync Polarity (Horizontal / Vertical)
720 x 400	31.50	70.10	28.30	-/+
640 x 480	31.50	59.90	25.20	-/-
640 x 480	37.50	75.00	31.50	-/-
800 x 600	37.90	60.30	40.00	+/+
800 x 600	46.90	75.00	49.50	+/+
1024 x 768	48.40	60.00	65.00	-/-
1024 x 768	60.00	75.00	78.80	+/+
1152 x 864	67.50	75.00	108.00	+/+
1280 x 720	45.00	59.94	74.25	-/+
1280 x 720	56.46	74.78	95.75	-/+
1280 x 1024	64.00	60.00	108.00	+/+
1280 x 1024	80.00	75.00	135.00	+/+
1600 x 900-R	60.00	60.00	108.00	+/+
1920 x 1080	67.50	60.00	148.50	+/+



Electrical specifications

Model	P2222H/P2422H/P2722H
Video input signals	<ul style="list-style-type: none"> ·Analog RGB, 0.7 Volts +/- 5%, positive polarity at 75 ohm input impedance ·HDMI 1.4, 600 mV for each differential line, 100 ohm input impedance per differential pair ·DisplayPort 1.2, 600 mV for each differential line, 100 ohm input impedance per differential pair
AC input voltage/frequency/current	100 VAC to 240 VAC / 50 Hz or 60 Hz ± 3 Hz / 1.5 A (typical)
Inrush current	120 V: 30 A (max.) at 0°C (cold start) 240 V: 60 A (max.) at 0°C (cold start)
Power consumption P2222H	0.2 W (Off mode) ¹ 0.3 W (Standby Mode) ¹ 11.8 W (On Mode) ¹ 46 W (Max.) ² 11.34 W (Pon) ³ 36.14 kWh (TEC) ³
Power consumption P2422H	0.2 W (Off mode) ¹ 0.3 W (Standby Mode) ¹ 12 W (On Mode) ¹ 48 W (Max.) ² 11.55 W (Pon) ³ 36.49 kWh (TEC) ³
Power consumption P2722H	0.2 W (Off mode) ¹ 0.2 W (Standby Mode) ¹ 15 W (On Mode) ¹ 55 W (Max.) ² 13.59 W (Pon) ³ 42.75 kWh (TEC) ³



¹ As defined in EU 2019/2021 and EU 2019/2013.

² Max brightness and contrast setting with maximum power loading on all USB ports.

³ Pon: Power consumption of On Mode measured with reference to Energy Star test method.

TEC: Total energy consumption in kWh measured with reference to Energy Star test method.

This document is informational only and reflects laboratory performance. Your product may perform differently, depending on the software, components and peripherals you ordered and shall have no obligation to update such information.

Accordingly, the customer should not rely upon this information in making decisions about electrical tolerances or otherwise. No warranty as to accuracy or completeness is expressed or implied.



Energy Star is a program run by the U.S. Environmental Protection Agency (EPA) and U.S. Department of Energy (DOE) that promotes energy efficiency.

This product qualifies for ENERGY STAR in the “factory default” settings and this is the setting in which power savings will be achieved.

Changing the factory default picture settings or enabling other features will increase power consumption that could exceed the limits necessary to qualify for ENERGY STAR rating.

For more information on the ENERGY STAR program, refer to energystar.gov.



Physical characteristics

Model	P2222H
Signal cable type	<ul style="list-style-type: none">• Digital: DisplayPort, 20 pins• Digital: HDMI, 19 pins (cable not included, except for Brazil)• Analog: D-Sub, 15 pins (cable not included, except for Japan)• Universal Serial Bus: USB, 9 pins
Dimensions (with stand)	
Height (extended)	481.99 mm (18.98 in.)
Height (compressed)	364.00 mm (14.33 in.)
Width	487.26 mm (19.18 in.)
Depth	179.57 mm (7.07 in.)
Dimensions (without stand)	
Height	289.99 mm (11.42 in.)
Width	487.26 mm (19.18 in.)
Depth	52.15 mm (2.05 in.)
Stand dimensions	
Height (extended)	410.80 mm (16.17 in.)
Height (compressed)	364.00 mm (14.33 in.)
Width	245.00 mm (9.65 in.)
Depth	179.57 mm (7.07 in.)
Base	245.00 x 173.00 mm (9.65 in. x 6.81 in.)
Weight	
Weight with packaging	6.37 kg (14.04 lb)
Weight with stand assembly and cables	4.83 kg (10.65 lb)
Weight without stand assembly (no cables)	2.82 kg (6.22 lb)
Weight of stand assembly	1.75 kg (3.86 lb)
Front-frame gloss	Black frame 2-4 gloss units



Model		P2422H
Signal cable type	<ul style="list-style-type: none"> • Digital: DisplayPort, 20 pins • Digital: HDMI, 19 pins (cable not included, except for Brazil) • Analog: D-Sub, 15 pins (cable not included, except for Japan) • Universal Serial Bus: USB, 9 pins 	
Dimensions (with stand)		
Height (extended)	496.11 mm (19.53 in.)	
Height (compressed)	364.00 mm (14.33 in.)	
Width	537.80 mm (21.17 in.)	
Depth	179.57 mm (7.07 in.)	
Dimensions (without stand)		
Height	318.50 mm (12.54 in.)	
Width	537.80 mm (21.17 in.)	
Depth	52.15 mm (2.05 in.)	
Stand dimensions		
Height (extended)	410.80 mm (16.17 in.)	
Height (compressed)	364.00 mm (14.33 in.)	
Width	245.00 mm (9.65 in.)	
Depth	179.57 mm (7.07 in.)	
Base	245.00 x 173.00 mm (9.65 in. x 6.81 in.)	
Weight		
Weight with packaging	7.95 kg (17.53 lb)	
Weight with stand assembly and cables	5.57 kg (12.28 lb)	
Weight without stand assembly (no cables)	3.39 kg (7.47 lb)	
Weight of stand assembly	1.76 kg (3.88 lb)	
Front-frame gloss	Black frame 2-4 gloss units	



Model	P2722H
Signal cable type	<ul style="list-style-type: none"> • Digital: DisplayPort, 20 pins • Digital: HDMI, 19 pins (cable not included, except for Brazil) • Analog: D-Sub, 15 pins (cable not included, except for Japan) • Universal Serial Bus: USB, 9 pins
Dimensions (with stand)	
Height (extended)	534.15 mm (21.03 in.)
Height (compressed)	384.15 mm (15.12 in.)
Width	609.90 mm (24.01 in.)
Depth	190.10 mm (7.48 in.)
Dimensions (without stand)	
Height	359.60 mm (14.16 in.)
Width	609.90 mm (24.01 in.)
Depth	52.15 mm (2.05 in.)
Stand dimensions	
Height (extended)	428.30 mm (16.68 in.)
Height (compressed)	381.50 mm (15.02 in.)
Width	268.00 mm (10.55 in.)
Depth	190.10 mm (7.48 in.)
Base	268.00 x 185.00 mm (10.55 in. x 7.28 in.)
Weight	
Weight with packaging	9.31 kg (20.52 lb)
Weight with stand assembly and cables	6.77 kg (14.93 lb)
Weight without stand assembly (no cables)	4.38 kg (9.66 lb)
Weight of stand assembly	1.89 kg (4.17 lb)
Front-frame gloss	Black frame 2-4 gloss units



Environmental characteristics

Model	P2222H/P2422H/P2722H
Compliant Standards	
<ul style="list-style-type: none"> ENERGY STAR certified monitor. EPEAT Gold registered in the U.S. EPEAT registration varies by country. See www.epeat.net for registration status by country. RoHS-compliant. TCO and TCO Certified Edge Displays. BFR/PVC free monitor (excluding external cables). Meets NFPA 99 leakage current requirements. Arsenic-free glass and Mercury-free for the panel only. 	
Temperature	
Operating	0°C to 40°C (32°F to 104°F)
Non-operating	<ul style="list-style-type: none"> Storage: -20°C to 60°C (-4°F to 140°F) Shipping: -20°C to 60°C (-4°F to 140°F)
Humidity	
Operating	10% to 80% (non-condensing)
Non-operating	<ul style="list-style-type: none"> Storage 5% to 90% (non-condensing) Shipping 5% to 90% (non-condensing)
Altitude	
Operating (maximum)	5,000 m (16,400 ft)
Non-operating (maximum)	12,192 m (40,000 ft)
Thermal dissipation P2222H	<ul style="list-style-type: none"> 157.32 BTU/hour (maximum) 40.36 BTU/hour (On Mode)
Thermal dissipation P2422H	<ul style="list-style-type: none"> 164.16 BTU/hour (maximum) 41.04 BTU/hour (On Mode)
Thermal dissipation P2722H	<ul style="list-style-type: none"> 188.10 BTU/hour (maximum) 51.30 BTU/hour (On Mode)



Pin assignments

VGA connector



Pin number	15-pin side of the connected signal cable
1	Video-Red
2	Video-Green
3	Video-Blue
4	GND
5	Self-test
6	GND-R
7	GND-G
8	GND-B
9	Computer 5 V/3.3 V
10	GND-sync
11	GND
12	DDC data
13	H-sync
14	V-sync
15	DDC clock



DisplayPort connector

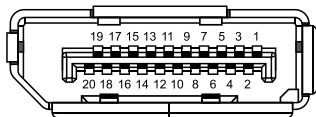

Pin number	20-pin side of the connected signal cable
1	ML3 (n)
2	GND
3	ML3 (p)
4	ML2 (n)
5	GND
6	ML2 (p)
7	ML1 (n)
8	GND
9	ML1 (p)
10	ML0 (n)
11	GND
12	ML0 (p)
13	GND
14	GND
15	AUX (p)
16	GND
17	AUX (n)
18	Hot Plug Detect
19	Re-PWR
20	+3.3 V DP_PWR



HDMI connector

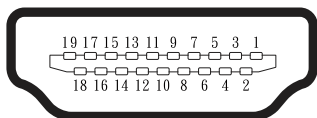

Pin number	19-pin side of the connected signal cable
1	TMDS DATA 2+
2	TMDS DATA 2 SHIELD
3	TMDS DATA 2-
4	TMDS DATA 1+
5	TMDS DATA 1 SHIELD
6	TMDS DATA 1-
7	TMDS DATA 0+
8	TMDS DATA 0 SHIELD
9	TMDS DATA 0-
10	TMDS CLOCK+
11	TMDS CLOCK SHIELD
12	TMDS CLOCK-
13	CEC
14	Reserved (N.C. on device)
15	DDC CLOCK (SCL)
16	DDC DATA (SDA)
17	DDC/CEC Ground
18	+5 V POWER
19	HOT PLUG DETECT



Universal Serial Bus (USB) interface

This section gives you information about the USB ports that are available on the monitor.

SuperSpeed USB 5 Gbps (USB3.2 Gen1)

Transfer speed	Data rate	Maximum power supported (each port)
SuperSpeed	5 Gbps	4.5 W
High speed	480 Mbps	4.5 W
Full speed	12 Mbps	4.5 W

USB 3.0 upstream connector

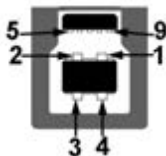

Pin number	9-pin side of the connector
1	VCC
2	D-
3	D+
4	GND
5	SSTX-
6	SSTX+
7	GND
8	SSRX-
9	SSRX+



USB 3.2 downstream connector



Pin number	9-pin side of the connector
1	VCC
2	D-
3	D+
4	GND
5	SSRX-
6	SSRX+
7	GND
8	SSTX-
9	SSTX+

 **NOTE: SuperSpeed USB 5 Gbps (USB 3.2 Gen1) functionality requires a SuperSpeed USB 5 Gbps (USB 3.2 Gen1)-capable computer.**

 **NOTE: The USB ports on the monitor work only when the monitor is turned On or in power save mode. If you turn Off the monitor and then turn it On, the attached peripherals may take a few seconds to resume normal functionality.**

Plug and play capability

You can install the monitor in any Plug and Play-compatible system. The monitor automatically provides the computer system with its Extended Display Identification Data (EDID) using Display Data Channel (DDC) protocols so the system can configure itself and optimize the monitor settings. Most monitor installations are automatic, you can select different settings if desired. For more information about changing the monitor settings, see [Operating your monitor](#).



LCD monitor quality and pixel policy

During the LCD Monitor manufacturing process, it is not uncommon for one or more pixels to become fixed in an unchanging state which are hard to see and do not affect the display quality or usability. For more information on Dell Monitor Quality and Pixel Policy, see Dell Support site at www.dell.com/pixelguidelines.

Maintenance guidelines

Cleaning your monitor

 **WARNING: Before cleaning the monitor, unplug the monitor power cable from the electrical outlet.**

 **CAUTION: Read and follow the [Safety instructions](#) before cleaning the monitor.**

For best practices, follow the instructions in the list below while unpacking, cleaning or handling your monitor:

- To clean your screen, lightly dampen a soft, clean cloth with water. If possible, use a special screen-cleaning tissue or solution suitable for the anti-static coating. Do not use benzene, thinner, ammonia, abrasive cleaners or compressed air.
- Use a lightly-dampened cloth to clean the monitor. Avoid using detergent of any kind as some detergents leave a milky film on the monitor.
- If you notice white powder when you unpack your monitor, wipe it off with a cloth.
- Handle your monitor with care as the black-colored monitor may get scratched and show white scuff marks.
- To help maintain the best image quality on your monitor, use a dynamically changing screen saver and turn off your monitor when not in use.



Setting up the monitor

Connecting the stand

 **NOTE:** The stand is detached when the monitor is shipped from the factory.

 **NOTE:** The following procedure is applicable for the stand that shipped with your monitor. If you are connecting a third-party stand, see the documentation that shipped with the stand.

1. Follow the instructions on the flaps of carton to remove the stand from the top cushion that secures it.
2. Remove the stand riser and stand base from the packaging cushion.



 **NOTE:** The graphics are used for the purpose of illustration only. The appearance of the package cushion may vary.

3. Insert the stand base blocks fully into the stand slot.
4. Lift the screw handle and turn the screw clockwise.
5. After fully tightening the screw, fold the screw handle flat within the recess.

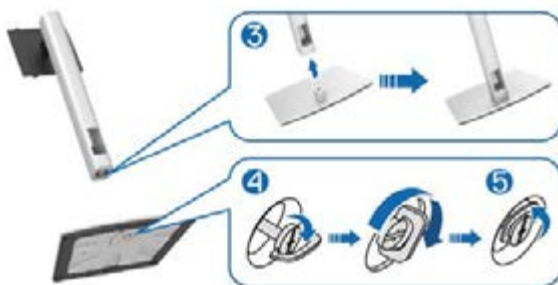

6. Lift the cover, as shown, to access the VESA area for stand assembly.



NOTE: Before attaching the stand assembly to the display, ensure that the front plate flap is opened to allow space for assembly.

7. Attach the stand assembly to the display.
 - a. Fit the two tabs on the upper part of the stand to the groove on the back of the display.
 - b. Press the stand down till it snaps into place.



8. Hold the stand riser and lift the monitor carefully, then place it on a flat surface.



 **NOTE: Lift the monitor carefully to prevent it from slipping or falling.**

9. Remove the cover from the monitor.



Connecting your monitor

⚠ WARNING: Before you begin any of the procedures in this section, follow the [Safety instructions](#).

✍ NOTE: Do not connect all cables to the monitor at the same time. It is recommend to route the cables through the cable-management slot before you connect them to the monitor.

To connect your monitor to the computer:

1. Turn off your computer and disconnect the power cable.
2. Connect the DisplayPort cable (shipped with your monitor) from your monitor to the computer.
3. Connect the HDMI or VGA cable (optional purchase) from your monitor to the computer.
4. Connect the USB upstream cable (shipped with your monitor) to an appropriate USB 3.0 port on your computer. (See [Bottom view](#) for details.)
5. Connect the USB peripherals to the SuperSpeed USB 5 Gbps (USB3.2 Gen 1) on the monitor.

Connecting the DisplayPort and USB cable

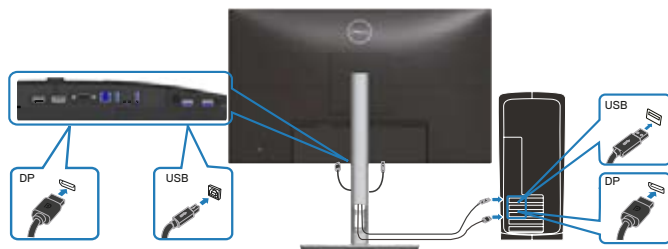

Connecting the HDMI cable (optional)

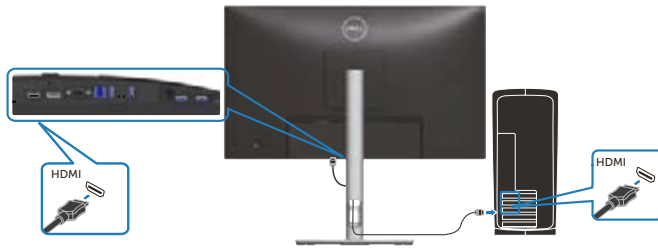

Connecting the VGA cable (optional)

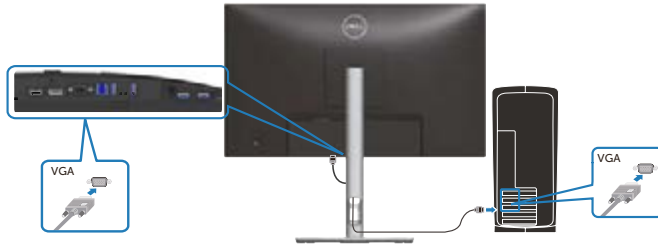

6. Connect the power cables from your computer and monitor into a wall outlet.

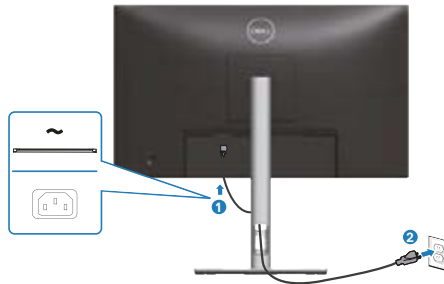

Organizing cables

Use the cable-management slot to route the cables connected to your monitor.



7. Turn on the Monitor.

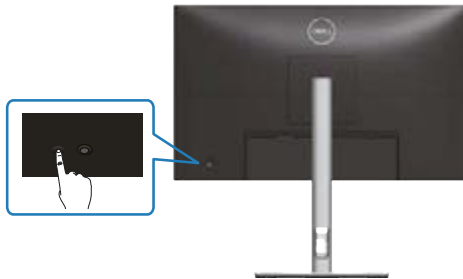

Removing the stand

 **NOTE:** To prevent scratches on the screen when removing the stand, ensure that the monitor is placed on a soft and clean surface.

 **NOTE:** The following procedure is applicable only for the stand that shipped with your monitor. If you are connecting a third-party stand, see the documentation that shipped with the stand.



1. Place the monitor on a soft cloth or cushion at the edge of the desk.
2. Press and hold the stand release button at the back of the display.
3. Lift the stand assembly up and away from the monitor.



Wall mounting (optional)



(Screw dimension: M4 x 10 mm).

See the documentation that shipped with the VESA-compatible wall mounting kit.

1. Place the display on a soft cloth or cushion at the edge of the desk.
2. Remove the stand. See [Removing the stand](#).
3. Remove the four screws that secure the display back cover.
4. Install the mounting bracket from the wall mounting kit to the display.
5. To mount the monitor on the wall, see the documentation that shipped with the wall mounting kit.

 **NOTE: For use only with UL or CSA or GS-listed wall mount bracket with minimum weight/load bearing capacity of 11.28 kg (P2222H) / 13.56 kg (P2422H) / 17.52 kg (P2722H).**



Operating your monitor

Power on the monitor

Press the Power button to turn On the monitor.

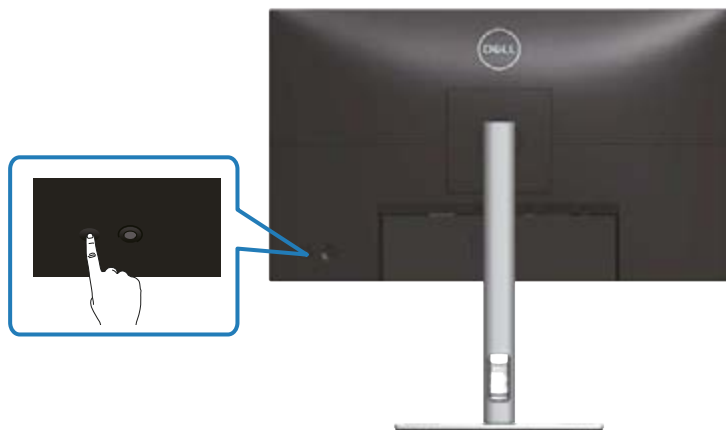

Using the joystick control

Use the joystick control on the rear of the monitor to make On-Screen Display (OSD) adjustments.

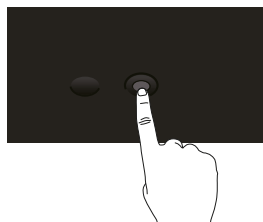

1. Press the joystick to launch the Menu Launcher.
2. Move the joystick up/down/left/right to toggle between options.
3. Press the joystick again to confirm the selection.



Using the On-Screen Display (OSD) menu



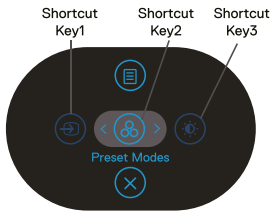

Accessing the Menu Launcher

When you toggle or press the joystick, the Menu Launcher appears to let you access the OSD main menu and shortcut functions.

To select a function, move the joystick.



The following table describes the Menu Launcher functions:





	Joystick	Description
1	 Shortcut key/ Input Source	To choose an input source from the list of video signals that may be connected to your monitor.
2	 Shortcut key/ Preset Modes	To choose a preferred color mode from the list of preset modes.
3	 Shortcut key/ Brightness/Contrast	To access the adjustment sliders of brightness and contrast.
4	 Menu	To launch the On-Screen Display (OSD) main menu. See Accessing the OSD menu .
5	 OK	To exit the Menu Launcher.

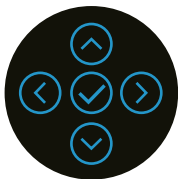

Using the navigation keys

When the OSD main menu is active, move the joystick to configure the settings, following the navigation keys displayed below the OSD.



	Joystick	Description
1	 Up	Use the Up direction to adjust (increase ranges) items in the OSD menu.
2	 Down	Use the Down direction to adjust (decrease ranges) items in the OSD menu.
3	 Left	For all first level in the Menu list, Left arrow will exit/close the OSD menu.
4	 Right	For all other levels except first level in the Menu list, Right arrow will go to the next level.
5	 OK	Press the joystick to confirm your selection.







Accessing the OSD menu

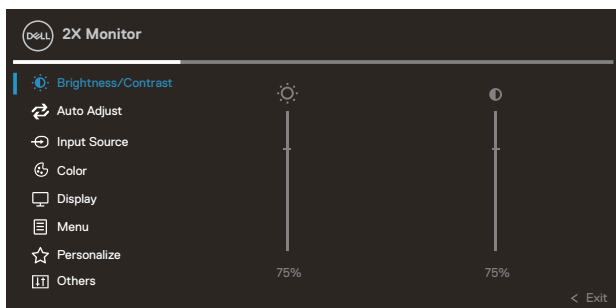





 **NOTE:** If you change the settings and then either proceed to another menu or exit the OSD menu, the monitor automatically saves those changes. The changes are also saved if you change the settings and then wait for the OSD menu to disappear.

1. Select the  icon to launch the OSD and display the main menu.



2. Press the  and  directions to move between the setting options. As you move from one icon to another, the option is highlighted.
3. Press the  or  directions once to activate the highlighted option.

 **NOTE:** The directional buttons (and the OK button) displayed may differ according to the menu you've selected. Use available buttons to make your selection.

4. Press  and  direction to select the desired parameter.
5. Press  and then use the  and  directions, according to the indicators on the menu, to make your changes.
6. Select the  to return to the main menu.



Icon	Menu and Submenus	Description
------	-------------------	-------------



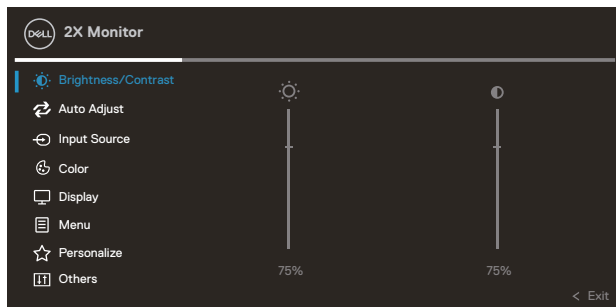

Brightness/Contrast

Use this menu to activate **Brightness/Contrast** adjustment.





Brightness

Brightness adjusts the luminance of the backlight.

Press the  direction to increase the brightness and press the  direction to decrease the brightness (min. 0 / max. 100).

Contrast

Adjust the **Brightness** first, and then adjust the **Contrast** only if further adjustment is necessary.

Press the  direction to increase the contrast and press the  direction to decrease the contrast (min. 0 / max. 100).

The **Contrast** function adjusts the degree of difference between darkness and lightness on the monitor screen.





Auto Adjust

Use this menu to activate **Auto Adjust** (only available for VGA input).

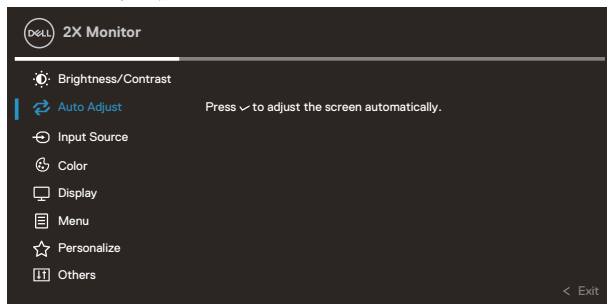

Auto Adjust allows the monitor to self-adjust to the incoming video signal. After using **Auto Adjust**, you can further tune your monitor by using the **Pixel Clock** (Coarse) and **Phase** (Fine) controls under **Display** settings.

NOTE: In most cases, **Auto Adjust** produces the best image for your configuration.



NOTE: **Auto Adjust** option is only available when you are using the analog (VGA) connector.

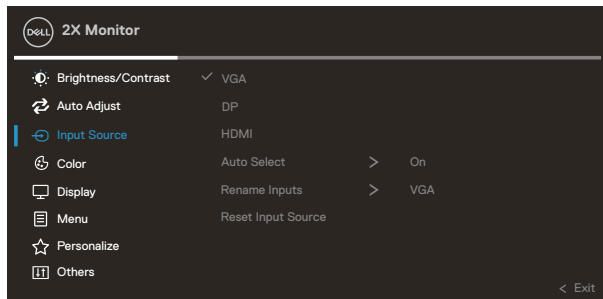

Input Source

Use the **Input Source** menu to select between the different video signals that may be connected to your monitor.



VGA	Select VGA input when you are using the VGA connector. Push  to select the VGA input source.
DP	Select DP input when you are using the DisplayPort connector. Push  to select the DP input source.
HDMI	Select HDMI input when you are using the HDMI connector. Push  to select the HDMI input source.
Auto Select	Choose Auto Select to scan for available input signals.

Rename Inputs

Reset Input Source	Select this option to restore default Input Source.
---------------------------	---



Color Use **Color** to adjust the color setting mode.

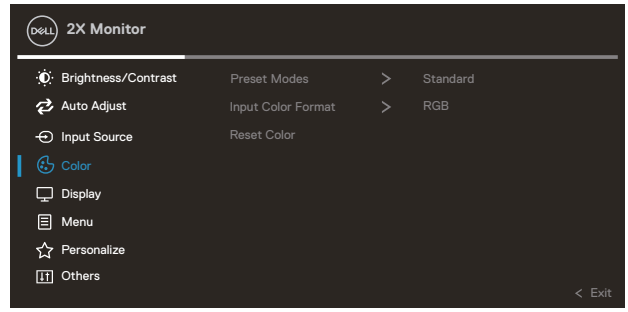

Preset Modes

Allows you to choose from a list of preset color modes.

- **Standard:** Loads the monitor's default color settings. This is the default preset mode.
- **Movie:** Loads color settings ideal for movies.
- **Game:** Loads color settings ideal for most gaming applications.
- **Warm:** Increases the color temperature. The screen appears warmer with a red/yellow tint.
- **Cool:** Decreases the color temperature. The screen appears cooler with a blue tint.
- **Custom Color:** Allows you to manually adjust the color settings.

Press the ⏪ and ⏩ directions to adjust the three colors (R, G, B) values and create your own preset color mode.

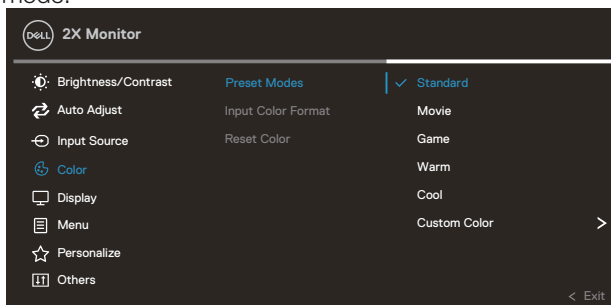



Input Color Format

Allows you to set the video input mode to:

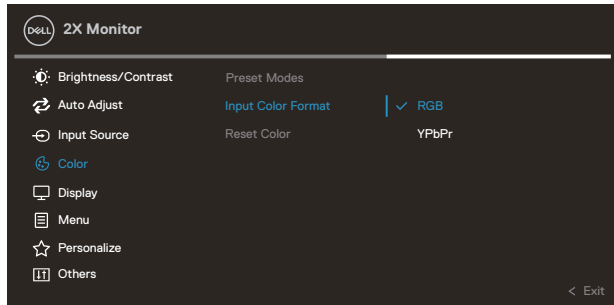
- **RGB:** Select this option if your monitor is connected to a computer or DVD player using the HDMI cable.
- **YCbCr(digital)/YPbPr(analog):** Select this option if your DVD player supports only YCbCr(digital)/YPbPr(analog) output.



Hue



This feature can shift the color of the video image to green or purple. This is used to adjust the desired flesh tone color. Use  or  to adjust the hue from 0 to 100.

Press  to increase the green shade of the video image.

Press  to increase the purple shade of the video image.

 **NOTE: Hue adjustment is available only when you select Movie and Game mode.**

Saturation

This feature can adjust the color saturation of the video image. Use  or  to adjust the saturation from 0 to 100.

Press  to increase the monochrome appearance of the video image.

Press  to increase the colorful appearance of the video image.

 **NOTE: Saturation adjustment is available only when you select Movie and Game mode.**



Reset Color

Resets your monitor's color settings to the factory default.



Display

Use the **display** to adjust image.

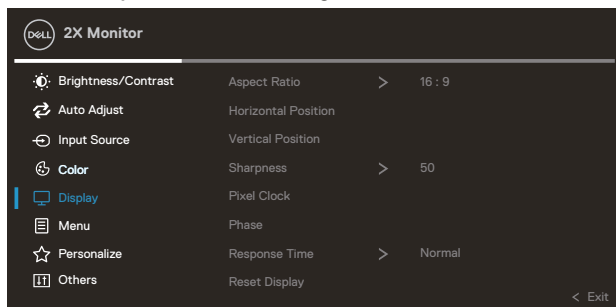

Aspect Ratio

Adjusts the image ratio to 16:9, 4:3 or 5:4.

Horizontal Position

Use \odot or \ominus to adjust the image left or right.
Minimum is '0' (\odot).
Maximum is '100' (\ominus).

Vertical Position

Use \odot or \ominus to adjust the image up or down.
Minimum is '0' (\odot).
Maximum is '100' (\ominus).

NOTE: **Horizontal Position** and **Vertical Position** adjustments are only available for VGA input.

Sharpness

This feature can make the image look sharper or softer.
Use \odot or \ominus to adjust the sharpness from 0 to 100.

Pixel Clock

The **Phase** and **Pixel Clock** adjustments allow you to adjust your monitor to your preference.
Use \odot or \ominus to adjust for best image quality.

Phase

If satisfactory results are not obtained using the **Phase** adjustment, use the **Pixel Clock** (coarse) adjustment and then use **Phase** (fine), again.

NOTE: **Pixel Clock** and **Phase** adjustments are only available for VGA input.



Response Time Allows you to set the **Response Time** to **Normal** or **Fast**.

Reset Display Resets all display settings to the factory default values.





Menu

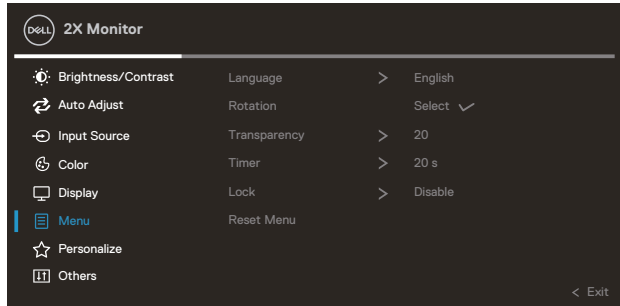

Select this option to adjust the settings of the OSD, such as, the languages of the OSD, the amount of time the menu remains on screen and so on.



Language Language options set the OSD display to one of the eight languages (English, Spanish, French, German, Brazilian Portuguese, Russian, Simplified Chinese, or Japanese).

Rotation Rotates the OSD by 90 degrees counter-clockwise. You can adjust the menu according to your Display Rotation.

Transparency Select this option to change the menu transparency by pressing the  and  directions from 0 to 100.

Timer OSD hold time: sets the length of time the OSD will remain active after the last time you pressed a direction. Use  or  to adjust the slider in 1 second increments, from 5 to 60 seconds.

Lock Controls user access to adjustments. User can select one of the following: Menu Button, Power Button, Menu + Power Buttons, Disable.

Reset Menu Reset all OSD settings to the factory preset values.





Personalize

Select this option to adjust the settings of the personalization.

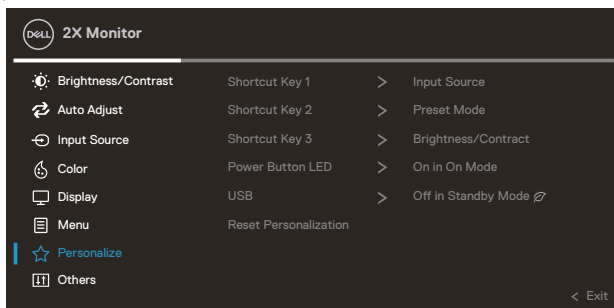

Shortcut Key 1 Allows you to choose a feature from **Preset Modes**, **Shortcut Key 2** **Brightness/Contrast**, **Auto Adjust**, **Input Source**, **Shortcut Key 3** **Aspect Ratio**, **Rotation**, **Display Info** and set it as a shortcut key.

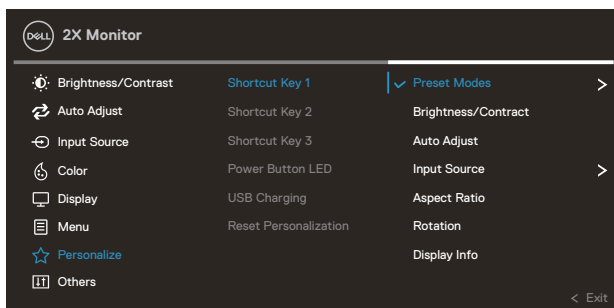

Power Button LED Allows you to set the power LED indicator On or Off to save energy.

USB Allows you to enable or disable USB function during monitor standby mode.

Reset Personalization Reset all settings under the **Personalize** menu to the default setting.





Others

Select this option to adjust the OSD settings, such as the DDC/CI, LCD conditioning, and so on.

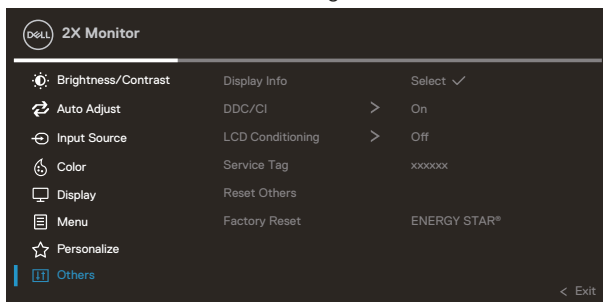

Display Info

Displays the monitor's current settings.

DDC/CI

DDC/CI (display data channel/command interface) allows your monitor parameters (brightness, color balance and etc.) to be adjustable via the software on your computer.

You can disable this feature by selecting **Off**.

Enable this feature by selecting on for best user experience and optimum performance of your monitor.

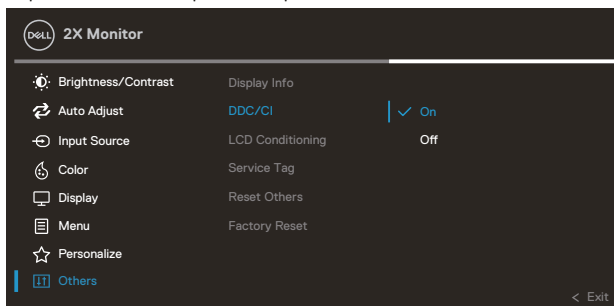

LCD Conditioning

Helps reduce minor cases of image retention. Depending on the degree of image retention, the program may take some time to run. To start LCD conditioning, select on.

Service Tag

Display the service tag number of the display. The Service Tag is a unique alphanumeric identifier that allows Dell to identify the product specifications and access warranty information.

 **NOTE: The Service Tag is also printed on a label located at the back of the cover.**

Reset Others

Reset all settings under the others setting menu to the factory preset values.

Factory Reset

Restore all preset values to the factory default settings. These are also the settings for ENERGY STAR® tests.

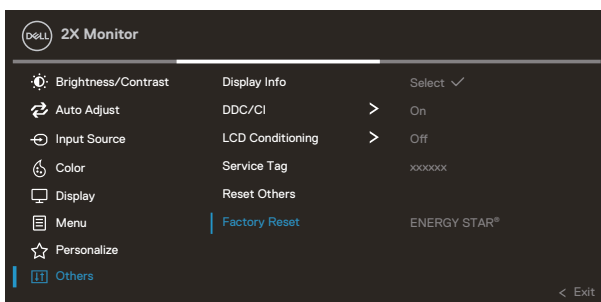

 **NOTE: Your monitor has a built-in feature to automatically calibrate the brightness to compensate for LED aging.**



Menu and Power button lock

Prevents users to access or change OSD menu settings on the display.

By default, the Menu and Power button lock setting is disabled.

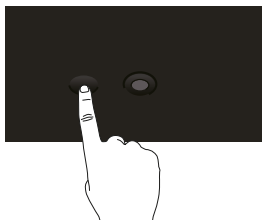

To access the lock menu, press and hold the Up or Down or Left or Right direction for four seconds. A lock menu appears at the bottom right corner of the display.

 **NOTE: The lock menu can be accessed using this method when the Menu and Power buttons are in unlocked state.**

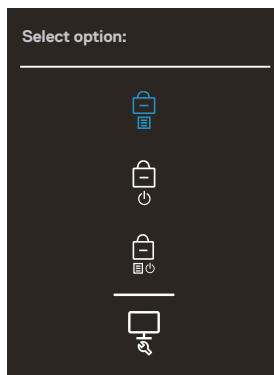



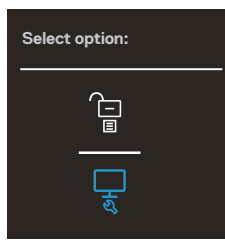

To access the unlock menu, press and hold the Up or Down or Left or Right direction for four seconds. An unlock menu appears at the bottom right corner of the display.

 **NOTE: The unlock menu can be accessed when the Menu and Power buttons are in locked state.**





There are three lock options.

	Menu	Description
1	Menu Buttons 	When Menu Buttons is selected, the OSD menu settings cannot be changed. All buttons are locked except Power button.
2	Power Button 	When Power Button is selected, the display cannot be turned off using the Power button.
3	Menu + Power Buttons 	When Menu + Power Buttons is selected, the OSD menu settings cannot be changed and the Power button is locked.
4	Built-in Diagnostics 	See Built-in diagnostics for more information.

 **NOTE: To access the Lock or Unlock menu – Press and hold the Up or Down or Left or Right direction for four seconds.**

In the following scenarios, the  icon appears at the center of the display:

- When Up or Down or Left or Right direction are pressed. This indicates the OSD menu buttons are in lock state.



- When the Power button is pressed. This indicates the Power button is in lock state.
- When Up or Down or Left or Right direction or Power button are pressed. This indicates OSD menu buttons and the Power button is in lock state.

Unlocking the OSD menu and Power buttons :

1. Press and hold the Up or Down or Left or Right direction for four seconds. The unlock menu appears.
2. Select the unlock icon  to unlock the buttons on the display.



OSD warning messages

When the monitor does not support a particular resolution mode, the following message is displayed:

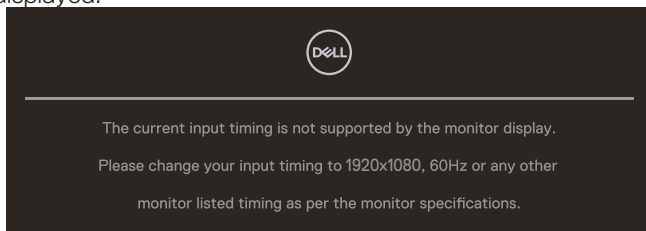

This means that the monitor cannot synchronize with the signal that it is receiving from the computer. See [Monitor specifications](#) for the Horizontal and Vertical frequency ranges addressable by this monitor. Recommended mode is **1920 x 1080**.

 **NOTE: The message may be slightly different according to the connected input signal.**

You will see the following message before the **DDC/CI** function is disabled:

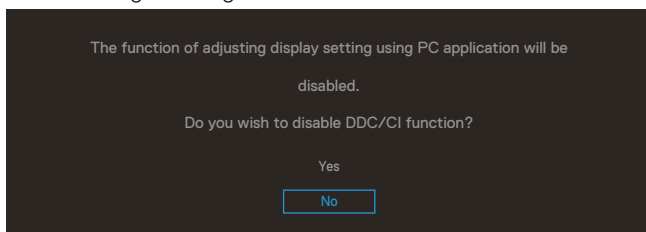

You will see the following message before the **Lock** function is activated:

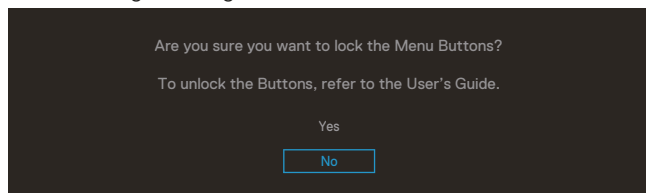

When the monitor goes into power-save mode, the following message appears:

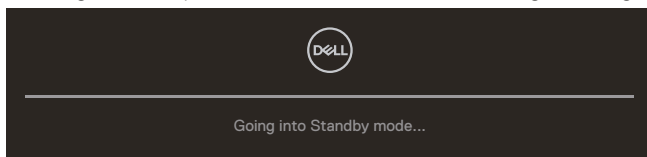

Activate the computer and wake up the monitor to gain access to the OSD.

NOTE: The message may be slightly different according to the connected input signal.

If either VGA, HDMI, or DisplayPort cable is not connected, a floating dialog box as shown below appears. The monitor will enter Standby Mode after 4 minutes if left at this state.

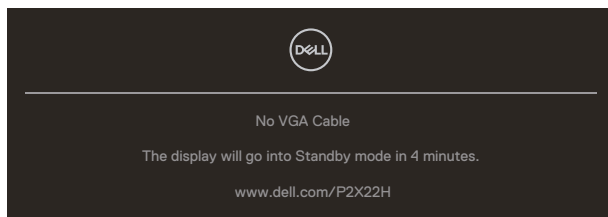

or

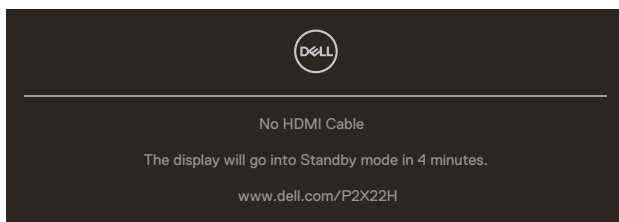

or

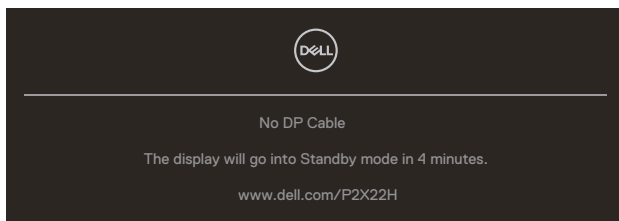

NOTE: The message may be slightly different according to the connected input signal.



The Power Warning Message box below shall apply to **Brightness** functions for the first time when user adjust the Brightness level above the default level.

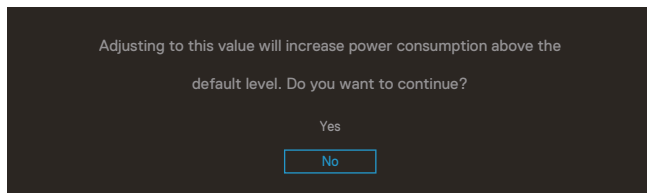

When **Factory Reset** is selected, the following message appears:

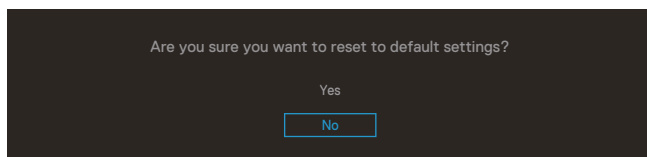

When you select 'Yes' to reset to default settings, the following message will appear:

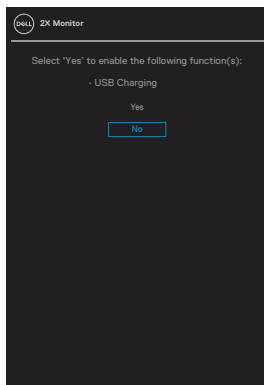

See [Troubleshooting](#) for more information.



Setting the maximum resolution

To set the maximum resolution for the monitor:

In Windows® 7, Windows® 8, Windows® 8.1:

1. For Windows 8 and Windows 8.1 only, select the Desktop tile to switch to classic desktop.
2. Right-click on the desktop and click **Screen Resolution**.
3. Click the dropdown list of the Screen Resolution and select **1920 x 1080**.
4. Click **OK**.

In Windows® 10:

1. Right-click on the desktop and click **Display settings**.
2. Click **Advanced display settings**.
3. Click the dropdown list of the **Resolution** and select **1920 x 1080**.
4. Click **Apply**.

If you do not see **1920 x 1080** as an option, you may need to update your graphics driver. Depending on your computer, complete one of the following procedures:

If you have a Dell desktop or portable computer:

- Go to www.dell.com/support, enter your computer's Service Tag, and download the latest driver for your graphics card.

If you are using a non-Dell computer (portable or desktop):

- Go to the support site for your computer and download the latest graphic drivers.
- Go to your graphics card website and download the latest graphic drivers.



Using the tilt, swivel, and vertical extension

NOTE: The following instructions are applicable only for attaching the stand that was shipped with your monitor. If you are attaching a stand that you purchased from any other source, follow the set up instructions that were included with the stand.

Tilt, swivel

With the stand attached to the monitor, you can tilt and swivel the monitor for the most comfortable viewing angle.

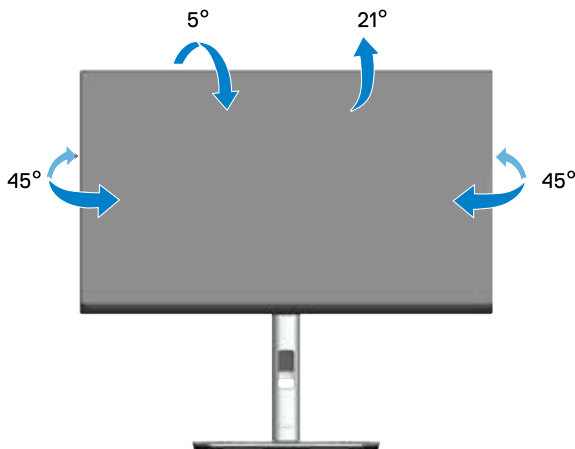

NOTE: The stand is detached when the monitor is shipped from the factory.

Vertical Extension

NOTE: The stand can be extended vertically up to 150 mm.

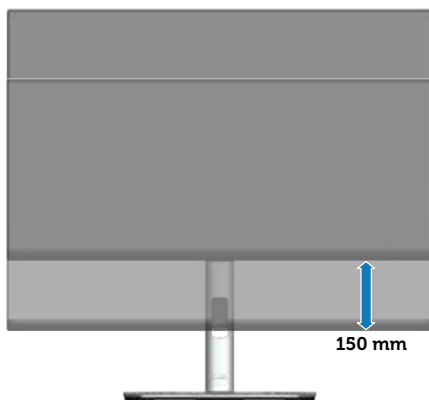

Rotating the monitor

Before you rotate the monitor, your monitor should be fully vertically extended (Vertical extension) and fully tilted up to avoid hitting the bottom edge of the monitor.

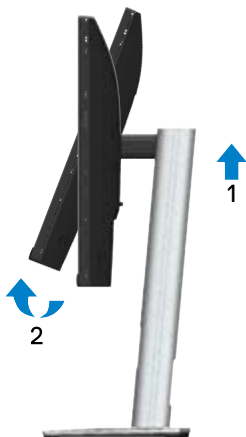

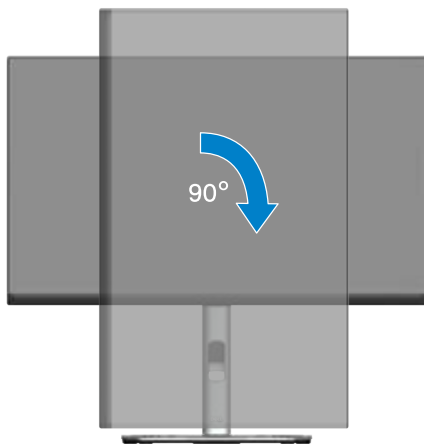

Rotate clockwise

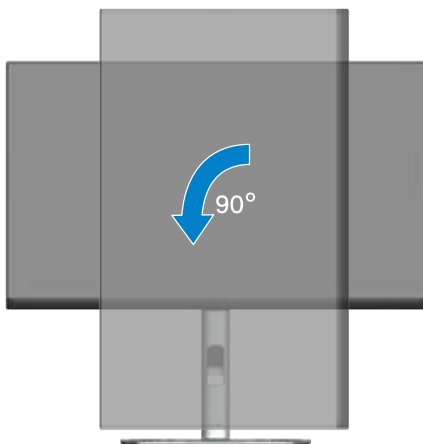

Rotate counterclockwise



-  **NOTE:** To use the Display Rotation function (Landscape versus Portrait view) with your Dell computer, you require an updated graphics driver that is not included with this monitor. To download the graphics driver, go to www.dell.com/support and see the Download section for Video Drivers for latest driver updates.
-  **NOTE:** When in the Portrait View Mode, you may experience performance degradation in graphic-intensive applications (3D Gaming and etc.).



Adjusting the rotation display settings of your system

After you have rotated your monitor, you need to complete the procedure below to adjust the Rotation Display Settings of your system.

 **NOTE: If you are using the monitor with a non-Dell computer, you need to go to the graphics driver website or your computer manufacturer website for information on rotating the 'contents' on your display.**

To adjust the Rotation Display Settings:

1. Right-click on the desktop and click **Properties**.
2. Select the **Settings** tab and click **Advanced**.
3. If you have an ATI graphics card, select the **Rotation** tab and set the preferred rotation.
4. If you have an NVIDIA graphics card, click the **NVIDIA** tab, in the left-hand column select **NVRotate**, and then select the preferred rotation.
5. If you have an Intel® graphics card, select the **Intel** graphics tab, click **Graphic Properties**, select the **Rotation** tab, and then set the preferred rotation.

 **NOTE: If you do not see the rotation option or it is not working correctly, go to www.dell.com/support and download the latest driver for your graphics card.**



Troubleshooting

 **WARNING: Before you begin any of the procedures in this section, follow the [Safety instructions](#).**

Self-Test

Your monitor provides a self-test feature that allows you to check if your monitor is functioning properly. If your monitor and computer are properly connected but the monitor screen remains dark, run the monitor self-test by performing the following steps:

1. Turn off both your computer and the monitor.
2. Disconnect all video cables from the monitor. This way, the computer doesn't have to be involved.
3. Turn on the monitor.

The floating dialog box should appear on-screen (against a black background), if the monitor cannot sense a video signal and is working correctly. While in self-test mode, the power LED remains white. Also, depending upon the selected input, one of the dialogs shown below will continuously scroll through the screen.

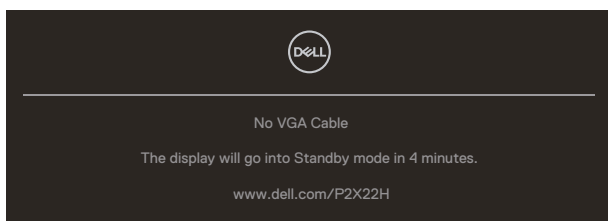

or

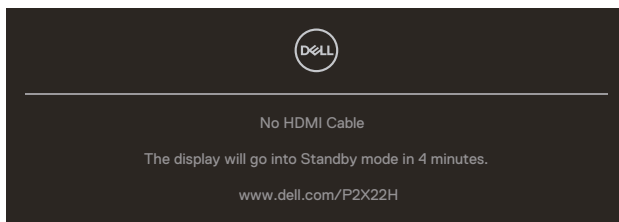

or



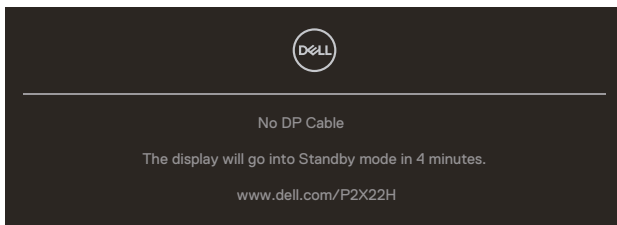

4. This box also appears during normal system operation, if the video cable becomes disconnected or damaged.
 5. Turn Off your monitor and reconnect the video cable; then turn On both your computer and the monitor.
- If your monitor screen remains blank after you use the previous procedure, check your video controller and computer, because your monitor is functioning properly.



Built-in diagnostics

Your monitor has a built-in diagnostic tool that helps you determine if any screen abnormality you experience is an inherent problem with your monitor, or with your computer and video card.

To run the built-in diagnostics:

1. Ensure that the screen is clean (no dust particles on the surface of the screen).
2. Move and hold the joystick up/down/left/right about 4 seconds until a pop-up menu appears.

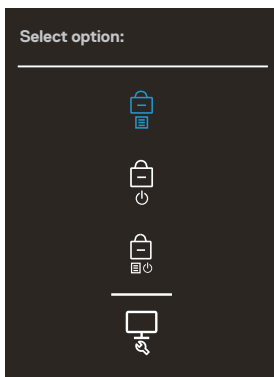

3. Move the joystick to highlight the Diagnostic icon  then press the joystick to confirm. A gray test pattern appears.

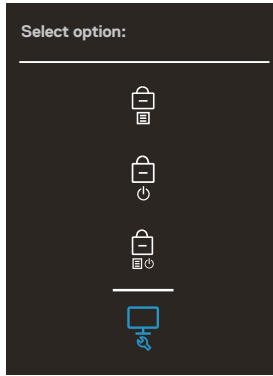

4. Carefully inspect the screen for abnormalities.
5. Press the joystick to change the test patterns.
6. Repeat steps 4 and 5 to inspect the display in red, green, blue, black, white, and text screens.
7. Press the joystick to end the diagnostic program.



Common problems

The following table contains general information about common monitor problems you might encounter and the possible solutions:

Common Symptoms	Possible Solutions
No Video/Power LED off	<p>Ensure that the video cable connecting the monitor and the computer is properly connected and secure.</p> <ul style="list-style-type: none">· Verify that the power outlet is functioning properly using any other electrical equipment.· Ensure that the power button is pressed.· Ensure that the correct input source is selected via the Input Source menu.
No Video/Power LED on	<ul style="list-style-type: none">· Increase brightness and contrast controls using the OSD.· Perform monitor self-test feature check.· Check for bent or broken pins in the video cable connector.· Run the built-in diagnostics.· Ensure that the correct input source is selected via the Input Source menu.
Poor Focus	<ul style="list-style-type: none">· Eliminate video extension cables.· Reset the monitor to Factory Settings (Factory Reset).· Change the video resolution to the correct aspect ratio.
Shaky/Jittery Video	<ul style="list-style-type: none">· Reset the monitor to Factory Settings (Factory Reset).· Check environmental factors.· Relocate the monitor and test in another room.
Missing Pixels	<ul style="list-style-type: none">· Cycle power On-Off.· Pixel that is permanently Off is a natural defect that can occur in LCD technology.· For more information on Dell Monitor Quality and Pixel Policy, see Dell Support site at: www.dell.com/pixelguidelines.
Stuck-on Pixels	<ul style="list-style-type: none">· Cycle power On-Off.· Pixel that is permanently off is a natural defect that can occur in LCD technology.· For more information on Dell Monitor Quality and Pixel Policy, see Dell Support site at: www.dell.com/pixelguidelines.



Brightness Problems	<ul style="list-style-type: none"> Reset the monitor to Factory Settings (Factory Reset). Adjust brightness & contrast controls via OSD.
Geometric Distortion	<ul style="list-style-type: none"> Reset the monitor to Factory Settings (Factory Reset). Adjust horizontal & vertical controls via OSD.
Horizontal/Vertical Lines	<ul style="list-style-type: none"> Reset the monitor to Factory Settings (Factory Reset). Perform monitor self-test feature check and determine if these lines are also in self-test mode. Check for bent or broken pins in the video cable connector. Run the built-in diagnostics.
Synchronization Problems	<ul style="list-style-type: none"> Reset the monitor to Factory Settings (Factory Reset). Perform monitor self-test feature check to determine if the scrambled screen appears in self-test mode. Check for bent or broken pins in the video cable connector. Restart the computer in the safe mode.
Safety Related Issues	<ul style="list-style-type: none"> Do not perform any troubleshooting steps. Contact Dell immediately.
Intermittent Problems	<ul style="list-style-type: none"> Ensure that the video cable connecting the monitor to the computer is connected properly and is secure. Reset the monitor to Factory Settings (Factory Reset). Perform monitor self-test feature check to determine if the intermittent problem occurs in self-test mode.
Missing Color	<ul style="list-style-type: none"> Perform monitor self-test feature check. Ensure that the video cable connecting the monitor to the computer is connected properly and is secure. Check for bent or broken pins in the video cable connector.
Wrong Color	<ul style="list-style-type: none"> Change the Color Setting Mode in the Color Settings OSD to Graphics or Video depending on the application. Try different Preset Modes in Color settings OSD. Adjust R/G/B value in Custom Color in Color settings OSD. Change the Input Color Format to RGB or YCbCr(digital)/YPbPr(analog) in the Color settings OSD. Run the built-in diagnostics.



Image retention from a static image left on the monitor for a long period of time

- Set the screen to turn off after a few minutes of screen idle time. These can be adjusted in Windows Power Options or Mac Energy Saver setting.
- Alternatively, use a dynamically changing screensaver.

Video Ghosting or Overshooting

- Change the **Response Time** in the **Display** OSD to **Normal**, or **Fast** depending on your application and usage.
-



Product-specific problems

Specific Symptoms	Possible Solutions
Screen image is too small	<ul style="list-style-type: none">• Check the Aspect Ratio setting in the Display settings OSD.• Reset the monitor to Factory Settings (Factory Reset).
Cannot adjust the monitor with the joystick	<ul style="list-style-type: none">• Turn Off the monitor, unplug the power cord, plug it back, and then turn On the monitor.• Check whether the OSD menu is locked. If yes, move and hold the joystick up/down/left/right for 4 seconds to unlock (for more information, see Menu and Power button lock).
No Input Signal when user controls are pressed	<ul style="list-style-type: none">• Check the signal source. Ensure the computer is not in Standby Mode by moving the mouse or pressing any key on the keyboard.• Check if the video cable is plugged in properly. Disconnect and reconnect the video cable if necessary.• Reset the computer or video player.
The picture does not fill the entire screen	<ul style="list-style-type: none">• Due to different video formats (aspect ratio) of DVDs, the monitor may display in full screen.• Run the built-in diagnostics.

Universal Serial Bus (USB) specific problems

Specific Symptoms	Possible Solutions
USB interface is not working	<ul style="list-style-type: none">• Check that your monitor is turned On.• Reconnect the upstream cable to your computer.• Reconnect the USB peripherals (downstream connector).• Turn off the monitor and turn it on again.• Reboot the computer.• Certain USB devices such as portable hard drive require higher power source; connect the drive to the computer directly.



SuperSpeed USB 5 Gbps (USB 3.2 Gen1) interface is slow

- Check that your computer is SuperSpeed USB 5 Gbps (USB 3.2 Gen1)-compatible.
 - Some computers have USB 3.2, USB 2.0, and USB 1.1 ports. Ensure that the correct USB port is used.
 - Reconnect the upstream cable to your computer.
 - Reconnect the USB peripherals (downstream connector).
 - Reboot the computer.
-

Wireless USB peripherals stop working when a USB 3.2 device is plugged in

- Increase the distance between the USB 3.2 peripherals and the wireless USB receiver.
 - Position your wireless USB receiver as close as possible to the wireless USB peripherals.
 - Use a USB-extender cable to position the wireless USB receiver as far away as possible from the USB 3.2 port.
-



Appendix

 **WARNING: Use of controls, adjustments, or procedures other than those specified in this documentation may result in exposure to shock, electrical hazards, and/or mechanical hazards.**

For information on safety instructions, see the **Safety Environment and Regulatory Information (SERI)**.

FCC notices (U.S. Only) and other regulatory information

For FCC notices and other regulatory information, see the regulatory compliance website located at www.dell.com/regulatory_compliance.

Contacting Dell

For customers in the United States, call 800-WWW-DELL (800-999-3355).

 **NOTE: If you do not have an active Internet connection, you can find contact information on your purchase invoice, packing slip, bill, or Dell product catalog.**

Dell provides several online and telephone-based support and service options. Availability varies by country and product, and some services may not be available in your area.

- Online technical assistance — www.dell.com/support/monitors
- Contacting Dell — www.dell.com/contactdell

EU product database for energy label and product information sheet

P2222H: <https://eprel.ec.europa.eu/qr/549695>

P2422H: <https://eprel.ec.europa.eu/qr/550826>

P2722H: <https://eprel.ec.europa.eu/qr/545529>

P2222H WOST: <https://eprel.ec.europa.eu/qr/562066>

P2422H WOST: <https://eprel.ec.europa.eu/qr/562073>

