

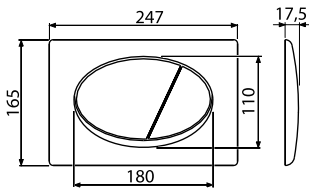

## M7x ■ M17x ■ M27x ■ M37x ■ M47x M137x ■ M147x

[ mm ]



M70, M71, M72, M73, M75

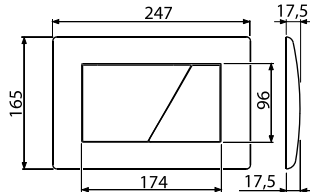

M170, M171, M172, M173, M175

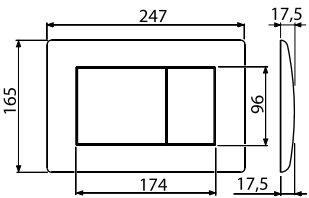

M270, M271, M272  
M275, M277, M278

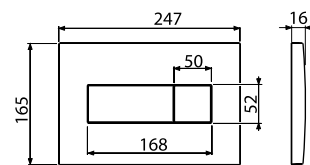

M370, M371, M372, M375, M378

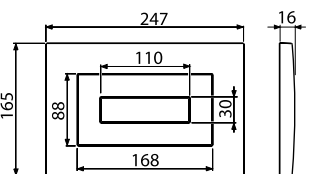

M470, M471, M472, M475, M478

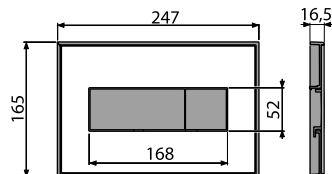

M1370, M1371, M1372, M1374,  
M1375, M1376,  
M1470, M1471, M1472, M1474,  
M1475

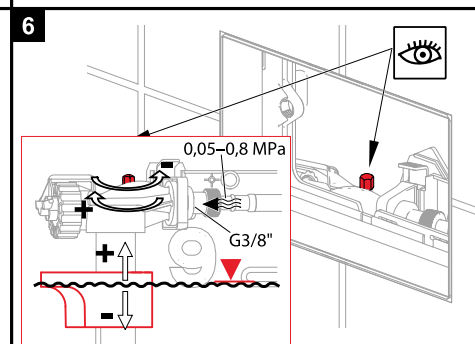
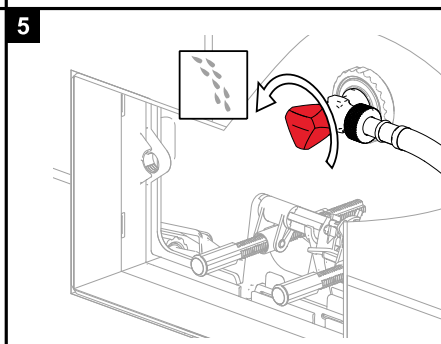
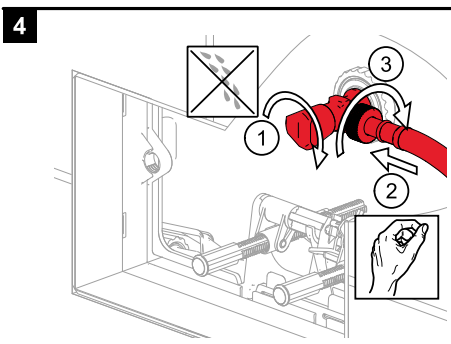
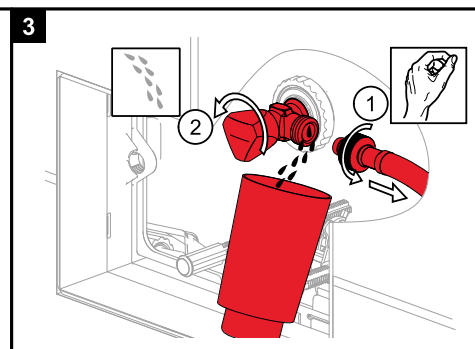
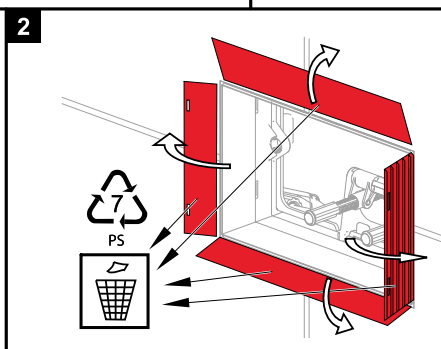
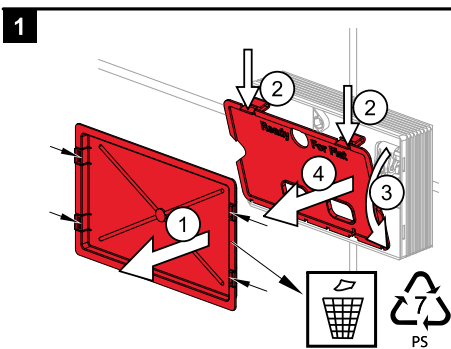
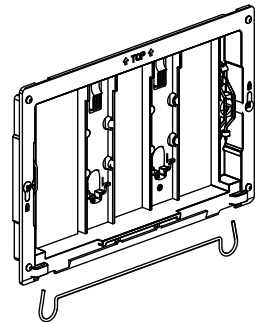
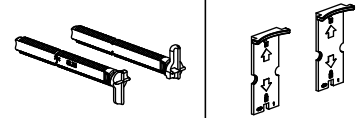
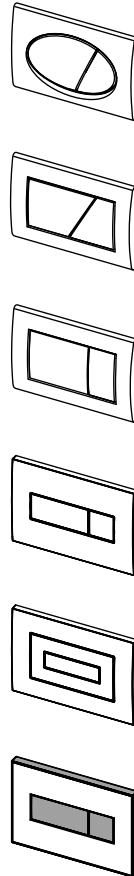

**7**

**8** A100, A101, A102, A112, A115, A116  
AM100, AM101, AM102, AM112, AM115, AM116

SLIM - A1101B, A1112B, A1115B  
AM1101B, AM1112B, AM1115B

ABS

**9**

**10**

**11**

(min 20 mm)

ABS

**L = 28 mm**

**L = 21 mm**

**L = 20 mm**

**12**

**13**

**14**

30l

6l

**15**

ZIRAVINA / CAUSTIC / CI

Alca plast, s. r. o.  
Bratislavská 2846, 690 02 Břeclav, Česká republika  
Tel.: +420 519 821 117 – prodej ČR  
Tel.: +420 519 821 041 – export, Fax: +420 519 821 083  
e-mail: [alcaplast@alcaplast.cz](mailto:alcaplast@alcaplast.cz), [www.alcaplast.cz](http://www.alcaplast.cz)  
© 2018 Alcaplast, s.r.o.