



# User Guide

AC750 Wireless Dual Band Router

REV5.0.0 1910012397

# Contents

About This Guide .....	1
<b>Chapter 1. Get to Know About Your Router .....</b>	<b>2</b>
1. 1. Product Overview.....	3
1. 2. Panel Layout.....	3
1. 2. 1.Top View .....	3
1. 2. 2.The Back Panel.....	4
<b>Chapter 2. Connect Your Router.....</b>	<b>6</b>
2. 1. Position Your Router .....	7
2. 2. Connect Your Router.....	7
<b>Chapter 3. Log In.....</b>	<b>10</b>
<b>Chapter 4. Configure the Router .....</b>	<b>12</b>
4. 1. Status .....	13
4. 2. Quick Setup .....	14
4. 3. Operation Mode .....	15
4. 3. 1.Wireless Router Mode.....	15
4. 3. 2.Access Point Mode.....	15
4. 3. 3.Range Extender Mode.....	15
4. 4. Network .....	15
4. 4. 1. WAN.....	15
4. 4. 2. LAN.....	22
4. 4. 3. IPTV.....	22
4. 4. 4.MAC Clone.....	23
4. 5. Dual Band Selection .....	24
4. 6. Wireless(2.4GHz or 5GHz).....	24
4. 6. 1.Wireless Settings .....	24
4. 6. 2. WPS.....	25
4. 6. 3.Wireless Security .....	27
4. 6. 4.Wireless MAC Filtering .....	29
4. 6. 5.Wireless Advanced.....	30
4. 6. 6.Wireless Statistics .....	32
4. 7. Guest Network.....	32

4. 8.	DHCP.....	33
4. 8. 1.	DHCP Settings.....	34
4. 8. 2.	DHCP Client List.....	35
4. 8. 3.	Address Reservation.....	35
4. 9.	Forwarding.....	36
4. 9. 1.	Virtual Server.....	36
4. 9. 2.	Port Triggering.....	37
4. 9. 3.	DMZ.....	38
4. 9. 4.	UPnP.....	39
4. 10.	Security.....	40
4. 10. 1.	Basic Security.....	40
4. 10. 2.	Advanced Security.....	41
4. 11.	Parental Controls.....	43
4. 12.	Access Control.....	44
4. 13.	Advanced Routing.....	46
4. 13. 1.	Static Route List.....	46
4. 13. 2.	System Routing Table.....	47
4. 14.	Bandwidth Control.....	48
4. 14. 1.	Control Settings.....	48
4. 14. 2.	Rule List.....	48
4. 15.	IP & MAC Binding.....	49
4. 15. 1.	Binding Settings.....	50
4. 15. 2.	ARP List.....	50
4. 16.	Dynamic DNS.....	51
4. 17.	IPv6.....	54
4. 17. 1.	IPv6 Status.....	54
4. 17. 2.	IPv6 WAN.....	54
4. 17. 3.	IPv6 LAN.....	58
4. 18.	System Tools.....	59
4. 18. 1.	Time Settings.....	59
4. 18. 2.	LED Control.....	60
4. 18. 3.	Diagnostic.....	60
4. 18. 4.	Firmware Upgrade.....	62
4. 18. 5.	Factory Defaults.....	62
4. 18. 6.	Backup & Restore.....	63
4. 18. 7.	Reboot.....	63
4. 18. 8.	Administrator.....	64
4. 18. 9.	System Log.....	66
4. 18. 10.	Traffic Statistics.....	66

4. 19. Log Out.....	67
---------------------	----

## **Chapter 5. Configure the Router in Access Point Mode ..... 68**

5. 1. Status .....	69
5. 2. Quick Setup .....	70
5. 3. Operation Mode .....	70
5. 4. Network.....	71
5. 4. 1. LAN.....	71
5. 5. Dual Band Selection .....	72
5. 6. Wireless(2.4GHz or 5GHz).....	72
5. 6. 1.Wireless Settings .....	72
5. 6. 2. WPS.....	73
5. 6. 3.Wireless Security .....	75
5. 6. 4.Wireless MAC Filtering .....	77
5. 6. 5.Wireless Advanced.....	78
5. 6. 6.Wireless Statistics .....	79
5. 6. 7.Throughout Monitor.....	80
5. 7. Guest Network.....	80
5. 8. DHCP.....	81
5. 8. 1.DHCP Settings .....	81
5. 8. 2.DHCP Client List .....	83
5. 8. 3.Address Reservation .....	83
5. 9. System Tools .....	84
5. 9. 1.Time Settings .....	84
5. 9. 2.LED Control .....	85
5. 9. 3.Diagnostic .....	86
5. 9. 4.Firmware Upgrade.....	87
5. 9. 5.Factory Defaults .....	87
5. 9. 6.Backup & Restore .....	88
5. 9. 7.Reboot.....	88
5. 9. 8.Administrator .....	89
5. 9. 9.System Log .....	91
5. 10. Log Out.....	91

## **Chapter 6. Configure the Router in Range Extender Mode ..... 92**

6. 1. Status .....	93
6. 2. Quick Setup .....	94
6. 3. Operation Mode .....	94
6. 4. Network.....	95

6. 4. 1.	LAN.....	95
6. 5.	Wireless(2.4GHz or 5GHz).....	96
6. 5. 1.	Connect to Host Network .....	96
6. 5. 2.	Extended Network .....	97
6. 5. 3.	Wireless MAC Filtering .....	98
6. 5. 4.	Wireless Advanced.....	99
6. 5. 5.	Wireless Statistics .....	100
6. 6.	DHCP.....	101
6. 6. 1.	DHCP Settings .....	101
6. 6. 2.	DHCP Client List .....	102
6. 7.	System Tools .....	103
6. 7. 1.	Time Settings .....	103
6. 7. 2.	LED Control .....	104
6. 7. 3.	Diagnostic .....	104
6. 7. 4.	Firmware Upgrade.....	106
6. 7. 5.	Factory Defaults .....	106
6. 7. 6.	Backup & Restore .....	107
6. 7. 7.	Reboot.....	107
6. 7. 8.	Administrator .....	108
6. 7. 9.	System Log .....	110
6. 8.	Log Out.....	110
	<b>FAQ.....</b>	<b>111</b>



# About This Guide

This guide is a complement to Quick Installation Guide. The Quick Installation Guide provides instructions for quick internet setup, while this guide contains details of each function and demonstrates how to configure them.

When using this guide, please notice that features of the router may vary slightly depending on the model and software version you have, and on your location, language, and internet service provider. All screenshots, images, parameters and descriptions documented in this guide are used for demonstration only.

## Conventions

In this guide the following conventions are used:

Convention	Description
<u>Underlined</u>	Underlined words or phrases are hyperlinks. You can click to redirect to a website or a specific section.
Teal	Contents to be emphasized and texts on the web page are in teal, including the menus, items, buttons and so on.
>	The menu structures to show the path to load the corresponding page. For example, <a href="#">Advanced</a> > <a href="#">Wireless</a> > <a href="#">MAC Filtering</a> means the MAC Filtering function page is under the Wireless menu that is located in the Advanced tab.
 <b>Note:</b>	Ignoring this type of note might result in a malfunction or damage to the device.
 <b>Tips:</b>	Indicates important information that helps you make better use of your device.

\*Maximum wireless signal rates are the physical rates derived from IEEE Standard 802.11 specifications. Actual wireless data throughput and wireless coverage are not guaranteed and will vary as a result of network conditions, client limitations, and environmental factors, including building materials, obstacles, volume and density of traffic, and client location.

## More Info

- The latest software, management app and utility are available from the [Download Center](#) at <https://www.tp-link.com/support>.
- The Quick Installation Guide can be found where you find this guide or inside the package of the router.
- Specifications can be found on the product page at <https://www.tp-link.com>.
- A Technical Support Forum is provided for you to discuss our products at <https://forum.tp-link.com>.
- Our Technical Support contact information can be found at the [Contact Technical Support](#) page at <https://www.tp-link.com/support>.

## Chapter 1

---

# Get to Know About Your Router

---

This chapter introduces what the router can do and shows its appearance.

It contains the following sections:

- [Product Overview](#)
- [Panel Layout](#)

## 1.1. Product Overview

The TP-Link router is designed to fully meet the need of Small Office/Home Office (SOHO) networks and users demanding higher networking performance. The powerful antennas ensure continuous Wi-Fi signal to all your devices while boosting widespread coverage throughout your home, and the built-in Ethernet ports supply high-speed connection to your wired devices.

Moreover, it is simple and convenient to set up and use the TP-Link router due to its intuitive web interface and the powerful Tether app.

## 1.2. Panel Layout

### 1.2.1. Top View







The router's LEDs (view from left to right) are located on the front panel. You can check the router's working status by following the LED Explanation table.

#### LED Explanation

Name	Status	Indication
⏻ (Power)	On	The system has started up successfully.
	Flashing	The system is starting up or firmware is being upgraded. Do not disconnect or power off your router.
	Off	Power is off.



## LED Explanation

Name	Status	Indication
 (Wireless 2.4GHz)	On	The 2.4GHz wireless band is enabled.
	Off	The 2.4GHz wireless band is disabled.
 (Wireless 5GHz)	On	The 5GHz wireless band is enabled.
	Off	The 5GHz wireless band is disabled.
 (WPS)	On/Off	The light remains on for 5 minutes when a WPS connection is established, and then turns off.
	Flashing	WPS connection is in progress. This may take up to 2 minutes.
 (Ethernet)	On	At least one Ethernet port is connected to a powered-on device.
	Off	No Ethernet port is connected to a powered-on device.
 (Internet)	Green On	The router is connected to the internet.
	Orange On	The router's WAN port is connected, but there is no internet connection.
	Off	The router's WAN port is not connected.

### 1.2.2. The Back Panel



The following parts (view from left to right) are located on the back panel.

Item	Description
Power Port	For connecting the router to a power socket via the provided power adapter.
Power On/Off Button	Press this button to power on or off the router.

Item	Description
Reset Button	Press and hold this button until all the LEDs turn off to reset the router to its factory default settings.
Wi-Fi/WPS Button	Press this button, and immediately press the WPS button on your device. The WPS LED of the router should change from flashing to solid on, indicating successful WPS connection.
	Press and hold this button for about 5 seconds to turn on or off the wireless function of your router.
WAN Port	For connecting to a DSL/Cable modem, or an Ethernet port.
Ethernet Ports (1/2/3/4)	For connecting your PCs or other wired network devices to the router.
Antennas	Used for wireless operation and data transmitting. Upright them for the best Wi-Fi performance.

## Chapter 2

---

# Connect Your Router

---

This chapter contains the following sections:

- [Position Your Router](#)
- [Connect Your Router](#)

## 2.1. Position Your Router

- The product should not be located in a place where it will be exposed to moisture or excessive heat.
- Place the router in a location where it can be connected to multiple devices as well as to a power source.
- Make sure the cables and power cord are safely placed out of the way so they do not create a tripping hazard.
- The router can be placed on a shelf or desktop.
- Keep the router away from strong devices with strong electromagnetic interference, such as Bluetooth devices, cordless phones and microwaves.

## 2.2. Connect Your Router

This mode enables multiple users to share internet connection via ADSL/Cable Modem.

1. Follow the steps below to connect your router.

If your internet connection is through an Ethernet cable directly from the wall instead of through a DSL / Cable / Satellite modem, connect the Ethernet cable to the router's WAN port, and then follow Step 4 and 5 to complete the hardware connection.

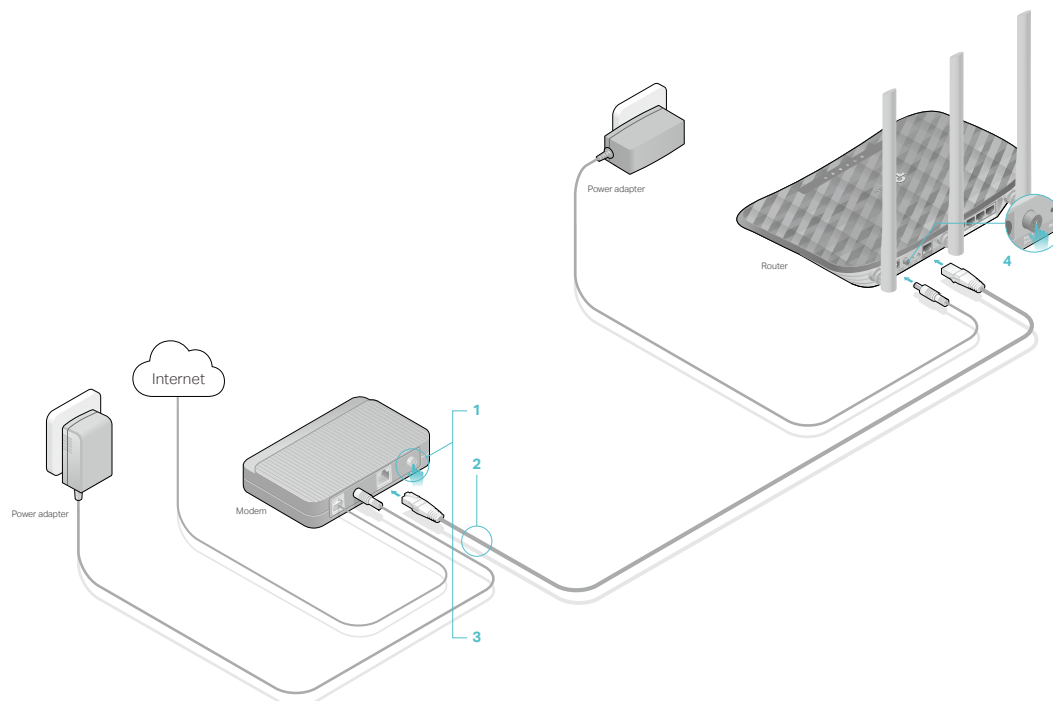

- 1) Turn off the modem, and remove the backup battery if it has one.
- 2) Connect the modem to the **Internet port** on your router with an Ethernet cable.
- 3) Turn on the modem, and then wait about **2 minutes** for it to restart.

- 4) Connect the power adapter to the router and turn on the router.
- 5) Verify that the hardware connection is correct by checking these LEDs.



**Note:**

If the 2.4G and 5G Wi-Fi LEDs are off, press and hold the Wi-Fi/WPS button on the rear panel for about 3 seconds, then release the button. Both LEDs will turn on.

## 2. Connect your computer to the router.

### • Method 1: Wired

Turn off the Wi-Fi on your computer and connect the devices using an Ethernet cable.

### • Method 2: Wirelessly

- 1) Find the SSID (Network Name) and Wireless Password printed on the label at the bottom of the router.
- 2) Click the network icon of your computer or go to Wi-Fi Settings of your smart device, and then select the SSID to join the network.

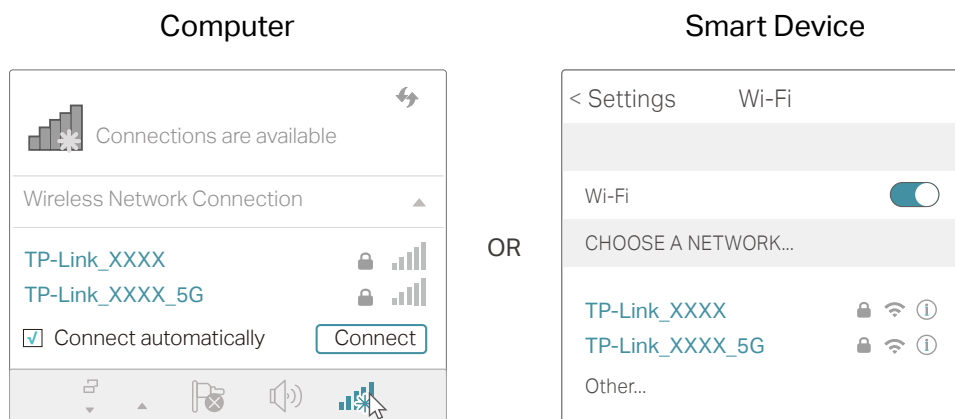

### • Method 3: Use the WPS button

Wireless devices that support WPS, including Android phones, tablets and most USB network cards, can be connected to your router through this method ( Not supported by iOS devices).

**Note:**

The WPS function cannot be configured if the wireless function of the router is disabled. Also, the WPS function will be disabled if your wireless encryption is WEP. Please make sure the wireless function is enabled and is configured with the appropriate encryption before configuring the WPS.

- 1) Tap the WPS icon on the device's screen. Here takes an Android phone as an example.
- 2) Immediately press the WPS button on your router.

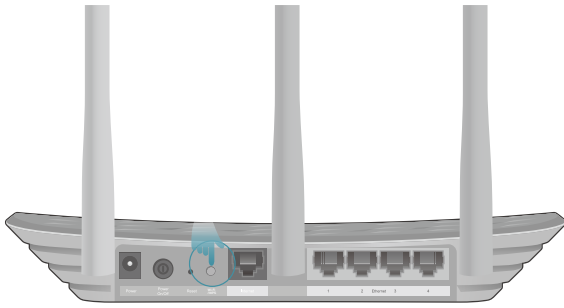

Close to

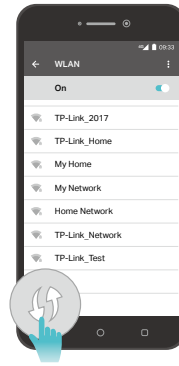

## Chapter 3

---

# Log In

---

This chapter introduces how to log in to the web management page of router.

With the web management page, it is easy to configure and manage the router. The web management page can be used on any Windows, Macintosh or UNIX OS with a Web browser, such as Microsoft the Internet Explorer, Mozilla Firefox or Apple Safari.

Follow the steps below to log in to your router.

1. Set up the TCP/IP Protocol in [Obtain an IP address automatically](#) mode on your computer.
2. Visit <http://tplinkwifi.net>, and log in with the username and password you set for the router. The default one is [admin](#) (all lowercase) for both username and password.



**Note:**

If the login window does not appear, please refer to the [FAQ](#) section.



## Chapter 4

---

# Configure the Router

---

This chapter presents how to configure the various features of the router.

It contains the following sections:

- Status
- Quick Setup
- Operation Mode
- Network
- Dual Band Selection
- Wireless(2.4GHz or 5GHz)
- Guest Network
- DHCP
- Forwarding
- Security
- Parental Controls
- Access Control
- Advanced Routing
- Bandwidth Control
- IP & MAC Binding
- Dynamic DNS
- IPv6
- System Tools
- Log Out

## 4. 1. Status

1. Visit <http://tplinkwifi.net>, and log in with the username and password you set for the router.
2. Go to **Status**. You can view the current status information of the router.

Status	
Firmware Version:	██
Hardware Version:	Archer C20 ██████████
LAN	
MAC Address:	00 0A EB 20 05 A0
IP Address:	192.168.0.1
Subnet Mask:	255.255.255.0
Wireless 2.4GHz	
Operation Mode:	Router
Wireless Radio:	Enabled
Name(SSID):	TP-Link_05A0
Mode:	11bgn mixed
Channel:	Auto(Channel 1)
Channel Width:	Auto
MAC Address:	00 0A EB 20 05 A0
Wireless 5GHz	
Operation Mode:	Router
Wireless Radio:	Enabled
Name(SSID):	TP-Link_05A0_5G
Mode:	11a/n/ac mixed
Channel:	Auto(Channel 36)
Channel Width:	Auto
MAC Address:	00 0A EB 20 05 9F
WAN	
MAC Address:	00 0A EB 20 05 A1
IP Address:	0.0.0.0(Dynamic IP)
Subnet Mask:	0.0.0.0
Default Gateway:	0.0.0.0 <b>Unplugged</b>
DNS Server:	0.0.0.0 0.0.0.0
Ethernet	
Internet:	Unplugged
LAN1:	Unplugged
LAN2:	Unplugged
LAN3:	100Mbps full duplex
LAN4:	Unplugged
System Up Time: 0 day(s) 00:01:47 <input type="button" value="Refresh"/>	

- **Firmware Version** - The version information of the router's firmware.
- **Hardware Version** - The version information of the router's hardware.
- **LAN** - This field displays the current settings of the LAN, and you can configure them on the **Network > LAN** page.
  - **MAC address** - The physical address of the router.
  - **IP address** - The LAN IP address of the router.
  - **Subnet Mask** - The subnet mask associated with the LAN IP address.
- **Wireless 2.4GHz/5GHz** - This field displays the basic information or status of the wireless function, and you can configure them on the **Wireless > Basic Settings** page.

- **Operation Mode** - The current wireless working mode in use.
- **Wireless Radio** - Indicates whether the wireless radio feature of the router is enabled or disabled.
- **Name(SSID)** - The SSID of the Router.
- **Mode** - The current wireless mode which the router works on.
- **Channel** - The current wireless channel in use.
- **Channel Width** - The current wireless channel width in use.
- **MAC Address** - The physical address of the router.
- **WAN** - This field displays the current settings of the WAN, and you can configure them on the **Network > WAN** page.
  - **MAC Address** - The physical address of the WAN port.
  - **IP Address** - The current WAN (Internet) IP Address. This field will be blank or 0.0.0.0 if the IP Address is assigned dynamically and there is no internet connection.
  - **Subnet Mask** - The subnet mask associated with the WAN IP Address.
  - **Default Gateway** - The Gateway currently used is shown here. When you use Dynamic IP as the internet connection type, click **Renew** or **Release** here to obtain new IP parameters dynamically from the ISP or release them.
  - **DNS Server** - The IP addresses of DNS (Domain Name System) server.
- **Ethernet** - Displays the current status of the Ethernet ports.
- **System Up Time** - The length of the time since the router was last powered on or reset.

Click **Refresh** to get the latest status and settings of the router.

## 4. 2. Quick Setup

1. Visit <http://tplinkwifi.net>, and log in with the username and password you set for the router.
2. Go to **Quick Setup**.



3. Click **Next** to start. Then follow the step-by-step instructions to connect your router to the internet.

## 4.3. Operation Mode

The router supports three operation modes: Wireless Router mode, Access Point mode and Range Extender.

### 4.3.1. Wireless Router Mode

The default Wireless Router mode is required most commonly. In this mode, the device enables multiple users to share the internet connection via ADSL/Cable Modem.

For hardware connection, refer to [Connect Your Router](#).

### 4.3.2. Access Point Mode

In this mode, the device can be connected to a wired network and transform the wired access into wireless one. If you already have a wired router, you can use this mode. Refer to [Configure the Router in Access Point Mode](#) session for detailed information.

### 4.3.3. Range Extender Mode

In this mode, the device can copy and reinforce the existing wireless signal to extend the coverage of the signal, especially for a large space to eliminate signal-blind corners. Refer to [Configure the Router in Range Extender Mode](#) session for detailed information.

## 4.4. Network

### 4.4.1. WAN

1. Visit <http://tplinkwifi.net>, and log in with the username and password you set for the router.
2. Go to [Network > WAN](#).
3. Configure the IP parameters of the WAN and click [Save](#).

#### Dynamic IP

If your ISP provides the DHCP service, please select [Dynamic IP](#), and the router will automatically get IP parameters from your ISP.

Click [Renew](#) to renew the IP parameters from your ISP.

Click [Release](#) to release the IP parameters.

The screenshot shows the WAN Settings interface. At the top, the title is "WAN Settings". Below it, the "Connection Type" is set to "Dynamic IP" with a dropdown arrow. To the right of this is a "Detect" button and a red warning message: "WAN port is unplugged!". Below the connection type, there are three input fields for "IP Address:", "Subnet Mask:", and "Gateway:", all of which are currently empty. Underneath these fields are two buttons: "Renew" and "Release". A horizontal separator line is present. Below the line, the "MTU(Bytes)" is set to "1500" with a note "(1500 as default, do not change unless necessary)" and a "Hide" button to the right. Below that, the "Get IP with Unicast" checkbox is checked, with a note "(It is usually not required)". The "Set DNS server manually" checkbox is unchecked. The "Host Name" field contains the text "Archer\_C20". At the bottom of the form is a "Save" button.

- **MTU(Bytes)** - The normal MTU (Maximum Transmission Unit) value for most Ethernet networks is 1500 Bytes. It is not recommended that you change the default MTU size unless required by your ISP.
- **Get IP with Unicast** - A few ISPs' DHCP servers do not support the broadcast applications. If you cannot get the IP address normally, you can choose this option. (It is rarely required.)
- **Set DNS server manually** - If your ISP gives you one or two DNS addresses, select Set DNS server manually and enter the primary and secondary addresses into the correct fields. Otherwise, the DNS servers will be assigned automatically from your ISP.
- **Host Name** - This option specifies the name of the router.

## Static IP

If your ISP provides a static or fixed IP address, subnet mask, default gateway and DNS setting, please select **Static IP**.

The screenshot shows the WAN Settings interface with "Static IP" selected. The "Connection Type" dropdown is set to "Static IP" and the "Detect" button is visible. Below this, there are five input fields: "IP Address:" (0.0.0.0), "Subnet Mask:" (0.0.0.0), "Gateway:" (0.0.0.0), "Primary DNS Server:" (0.0.0.0), and "Secondary DNS Server:" (0.0.0.0) with a red "(optional)" label to its right. A horizontal separator line is present. Below the line, the "MTU(Bytes)" is set to "1500" with a note "(1500 as default, do not change unless necessary)" and a "Hide" button to the right.

- **IP Address** - Enter the IP address in dotted-decimal notation provided by your ISP.
- **Subnet Mask** - Enter the subnet mask in dotted-decimal notation provided by your ISP. Normally 255.255.255.0 is used as the subnet mask.

- **Gateway** - Enter the gateway IP address in dotted-decimal notation provided by your ISP.
- **Primary/Secondary DNS Server** - Enter one or two DNS addresses in dotted-decimal notation provided by your ISP. For the Secondary DNS Server, it is optional.
- **MTU (Bytes)** - The normal MTU (Maximum Transmission Unit) value for most Ethernet networks is 1500 Bytes. It is not recommended that you change the default MTU size unless required by your ISP.

## PPPoE

If your ISP provides PPPoE connection, select **PPPoE**.

The screenshot shows the 'WAN Settings' configuration page. The 'Connection Type' is set to 'PPPoE'. Below it are input fields for 'PPP Username', 'PPP Password', and 'Confirm password'. The 'Secondary Connection' is set to 'Disabled'. The 'Connection Mode' is set to 'Always on'. The 'Max Idle Time' is set to '15 minutes'. The 'Authentication Type' is set to 'AUTO\_AUTH'. There are 'Detect', 'Connect', and 'Disconnect' buttons at the bottom.

- **PPP Username/Password** - Enter the user name and password provided by your ISP. These fields are case-sensitive.
- **Confirm Password** - Enter the Password provided by your ISP again to ensure the password you entered is correct.
- **Secondary Connection** - It's available only for PPPoE connection. If your ISP provides an extra connection type, select **Dynamic IP** or **Static IP** to activate the secondary connection.
- **Connection Mode**
  - **Always On** - In this mode, the internet connection will be active all the time.
  - **Connect on Demand** - In this mode, the internet connection can be terminated automatically after a specified inactivity period (Max Idle Time) and be re-established when you attempt to access the internet again. If you want to keep your internet connection active all the time, please enter 0 in the **Max Idle Time** field. Otherwise, enter the number of minutes you want to have elapsed before your internet access disconnects.
  - **Connect Manually** - You can click **Connect/Disconnect** to connect/disconnect immediately. This mode also supports the **Max Idle Time** function as **Connect on Demand** mode. The internet connection can be disconnected automatically

after a specified inactivity period (Max Idle Time) and not be able to re-establish when you attempt to access the internet again.

- [Authentication Type](#) - Choose an authentication type.

**Note:**

- Sometimes the connection cannot be terminated although you have specified the [Max Idle Time](#) because some applications are visiting the internet continually in the background.

If you want to do some advanced configurations, please click [Advanced](#).

Service Name:	<input type="text"/>	(do not change unless necessary)
Server Name:	<input type="text"/>	(do not change unless necessary)
MTU(Bytes):	<input type="text" value="1480"/>	(1480 as default, do not change unless necessary)
Use IP address specified by ISP:	<input type="checkbox"/>	
Echo request interval:	<input type="text" value="0"/>	(0-120 seconds, 0 meaning no request)
Set DNS server manually:	<input type="checkbox"/>	
<input type="button" value="Save"/>		

- [Service Name/Server Name](#) - The service name and server name should not be configured unless you are sure it is necessary for your ISP. In most cases, leaving these fields blank will work.
- [MTU\(Bytes\)](#) - The default MTU size is 1480 bytes. It is not recommended that you change the default MTU size unless required by your ISP.
- [ISP Specified IP Address](#) - If your ISP does not automatically assign IP addresses to the router, please select [Use IP address specified by ISP](#) and enter the IP address provided by your ISP in dotted-decimal notation.
- [Echo request interval](#) - The router will detect Access Concentrator online at every interval. The default value is 0. You can input the value between 0 and 120. The value 0 means no detect.
- [DNS Server/Secondary DNS Server](#) - If your ISP does not automatically assign DNS addresses to the router, please select [Set DNS server manually](#) and enter the IP address in dotted-decimal notation of your ISP's primary DNS server. If a secondary DNS server address is available, enter it as well.

## L2TP

If your ISP provides L2TP connection, please select [L2TP](#).

WAN Settings

Connection Type: L2TP

Username:

Password:

Addressing Type:  Dynamic IP  Static IP

Server IP Address/Name:

IP Address: 0.0.0.0

Subnet Mask: 0.0.0.0

Gateway: 0.0.0.0

DNS Server: 0.0.0.0, 0.0.0.0

Internet IP Address: 0.0.0.0

Internet DNS: 0.0.0.0, 0.0.0.0

MTU(Bytes):  (1460 as default, do not change unless necessary)

Connection Mode:  Always on  
 Connect on demand  
 Connect manually

Max Idle Time:  minutes (0 meaning connection remains active at all times)

- **Username/Password** - Enter the user name and password provided by your ISP. These fields are case-sensitive.
- **Addressing Type** - Choose the addressing type given by your ISP, either Dynamic IP or Static IP. Click the **Connect** button to connect immediately. Click the **Disconnect** button to disconnect immediately.
- **Server IP Address/Name** - Enter server IP address or domain name provided by your ISP.
- **MTU(Bytes)** - The default MTU size is "1460" bytes, which is usually fine. It is not recommended that you change the default MTU Size unless required by your ISP.
- **Connection Mode**
  - **Always On** - In this mode, the internet connection will be active all the time.
  - **Connect on Demand** - In this mode, the internet connection can be terminated automatically after a specified inactivity period (Max Idle Time) and be re-established when you attempt to access the internet again. If you want to keep your internet connection active all the time, please enter 0 in the **Max Idle Time** field. Otherwise, enter the number of minutes you want to have elapsed before your internet access disconnects.
  - **Connect Manually** - You can click **Connect/Disconnect** to connect/disconnect immediately. This mode also supports the **Max Idle Time** function as **Connect on Demand** mode. The internet connection can be disconnected automatically



after a specified inactivity period (Max Idle Time) and not be able to re-establish when you attempt to access the internet again.

**Note:**

Sometimes the connection cannot be terminated although you have specified the [Max Idle Time](#) because some applications are visiting the internet continually in the background.

## PPTP

If your ISP provides PPTP connection, please select [PPTP](#).

The screenshot shows the 'WAN Settings' configuration page. The 'Connection Type' is set to 'PPTP'. Below it are fields for 'Username' and 'Password', with 'Connect' and 'Disconnect' buttons. The 'Addressing Type' is set to 'Dynamic IP'. There are fields for 'Server IP Address/Name', 'IP Address', 'Subnet Mask', 'Gateway', and 'DNS Server'. The 'Internet IP Address' and 'Internet DNS' fields are also present. The 'MTU(Bytes)' is set to 1420. The 'Connection Mode' is set to 'Always on'. The 'Max Idle Time' is set to 15 minutes. A 'Save' button is at the bottom.

- [Username/Password](#) - Enter the user name and password provided by your ISP. These fields are case-sensitive.
- [Addressing Type](#) - Choose the addressing type given by your ISP, either Dynamic IP or Static IP. Click the [Connect](#) button to connect immediately. Click the [Disconnect](#) button to disconnect immediately.
- [Server IP Address/Name](#) - Enter server IP address or domain name provided by your ISP.
- [MTU\(Bytes\)](#) - The default MTU size is "1420" bytes, which is usually fine. It is not recommended that you change the default MTU Size unless required by your ISP.
- [Connection Mode](#)
  - [Always On](#) - In this mode, the internet connection will be active all the time.
  - [Connect on Demand](#) - In this mode, the internet connection can be terminated automatically after a specified inactivity period (Max Idle Time) and be re-established when you attempt to access the internet again. If you want to keep your internet connection active all the time, please enter 0 in the [Max Idle Time](#)

field. Otherwise, enter the number of minutes you want to have elapsed before your internet access disconnects.

- **Connect Manually** - You can click **Connect/Disconnect** to connect/disconnect immediately. This mode also supports the **Max Idle Time** function as **Connect on Demand** mode. The internet connection can be disconnected automatically after a specified inactivity period (Max Idle Time) and not be able to re-establish when you attempt to access the internet again.

#### Note:

Sometimes the connection cannot be terminated although you have specified the **Max Idle Time** because some applications are visiting the internet continually in the background.

## BigPond Cable

If your ISP provides BigPond cable connection, please select **BigPond Cable**.

The screenshot shows the WAN Settings configuration interface. At the top, the title is "WAN Settings". Below it, the "Connection Type" is set to "BigPond Cable" with a "Detect" button next to it. There are input fields for "Username:", "Password:", "Auth Server:", and "Auth Domain:". The "MTU(Bytes)" field is set to "1500" with a note "(1500 as default, do not change unless necessary)". The "Connection Mode" section has three radio buttons: "Always on" (which is selected), "Connect on demand", and "Connect manually". The "Max Idle Time" field is set to "15" minutes, with a note "(0 meaning connection remains active at all times)". At the bottom of the form, there are "Connect" and "Disconnect" buttons, and a "Save" button centered below them.

- **Username/Password** - Enter the use name and password provided by your ISP. These fields are case-sensitive.
- **Auth Server** - Enter the authenticating server IP address or host name.
- **Auth Domain** - Type in the domain suffix server name based on your location.
- **MTU(Bytes)** - The default MTU size is 1500 bytes. It is not recommended that you change the default MTU size unless required by your ISP.
- **Connection Mode**
  - **Always On** - In this mode, the internet connection will be active all the time.
  - **Connect on Demand** - In this mode, the internet connection can be terminated automatically after a specified inactivity period (Max Idle Time) and be re-established when you attempt to access the internet again. If you want to keep your internet connection active all the time, please enter 0 in the **Max Idle Time**

field. Otherwise, enter the number of minutes you want to have elapsed before your internet access disconnects.

- **Connect Manually** - You can click **Connect/Disconnect** to connect/disconnect immediately. This mode also supports the **Max Idle Time** function as **Connect on Demand** mode. The internet connection can be disconnected automatically after a specified inactivity period (Max Idle Time) and not be able to re-establish when you attempt to access the internet again.

#### 4. 4. 2. LAN

1. Visit <http://tplinkwifi.net>, and log in with the username and password you set for the router.
2. Go to **Network > LAN**.
3. Configure the IP parameters of the LAN and click **Save**.

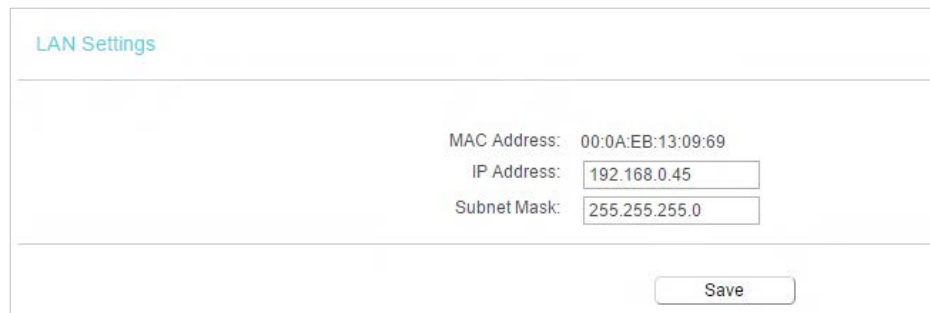

LAN Settings	
MAC Address:	00:0A:EB:13:09:69
IP Address:	<input type="text" value="192.168.0.45"/>
Subnet Mask:	<input type="text" value="255.255.255.0"/>
<input type="button" value="Save"/>	

- **MAC Address** - The physical address of the LAN ports. The value can not be changed.
- **IP Address** - Enter the IP address in dotted-decimal notation of your router (factory default - 192.168.0.254).
- **Subnet Mask** - An address code that determines the size of the network. Normally 255.255.255.0 is used as the subnet mask.

#### Note:

- If you have changed the IP address, you must use the new IP address to log in.
- If the new IP address you set is not in the same subnet as the old one, the IP address pool in the DHCP Server will be configured automatically, but the Virtual Server and DMZ Host will not take effect until they are re-configured.

#### 4. 4. 3. IPTV

1. Visit <http://tplinkwifi.net>, and log in with the username and password you set for the router.
2. Go to **Network > IPTV**.
3. Configure the IPTV settings and click **Save**.

- **IGMP Snooping** - IGMP snooping is designed to prevent hosts on a local network from receiving traffic for a multicast group they have not explicitly joined. IGMP snooping is especially useful for bandwidth-intensive IP multicast applications such as IPTV.
- **IGMP Proxy** - Select to enable IGMP Proxy.
- **IGMP Version** - Select the IGMP(Internet Group Management Protocol) Proxy Version, either V2 or V3, according to your ISP.
- **IPTV** - Select to enable the IPTV feature.
- **Mode** - Select the appropriate mode according to your ISP.
- **LAN 1/2/3/4** - Assign your LAN port to whether function as the Internet supplier or as the IPTV supplier.

#### 4. 4. 4. MAC Clone

1. Visit <http://tplinkwifi.net>, and log in with the username and password you set for the router.
2. Go to **Network > MAC Clone**.
3. Configure the WAN MAC address and click **Save**.

- **WAN MAC Address** - This field displays the current MAC address of the WAN port. If your ISP requires you to register the MAC address, please enter the correct MAC address in this field. Click **Restore Factory MAC** to restore the MAC address of WAN port to the factory default value.
- **Your PC's MAC Address** - This field displays the MAC address of the PC that is managing the router. If the MAC address is required, you can click **Clone MAC Address** and this MAC address will be filled in the **WAN MAC Address** field.

**Note:**

- You can only use the MAC Address Clone function for PCs on the LAN.
- If you have changed the WAN MAC address when the WAN connection is PPPoE, it will not take effect until the connection is re-established.

## 4.5. Dual Band Selection

1. Visit <http://tplinkwifi.net>, and log in with the username and password you set for the router.
2. Go to **Dual Band Selection**.
3. Select the working radio band as needed and click **Save**.



**Dual Band Selection**

---

Please select or clear the check box to enable or disable a given radio band.

2.4GHz

5GHz

---

Save

## 4.6. Wireless(2.4GHz or 5GHz)

### 4.6.1. Wireless Settings

1. Visit <http://tplinkwifi.net>, and log in with the username and password you set for the router.
2. Go to **Wireless > Basic Settings**.
3. Configure the basic settings for the wireless network and click **Save**.

- **Wireless** - Enable or disable wireless network.
- **Wireless Network Name** - Enter a value of up to 32 characters. The same Name (SSID) must be assigned to all wireless devices in your network.
- **Mode** - You can choose the appropriate “Mixed” mode.
- **Channel** - This field determines which operating frequency will be used. The default channel is set to **Auto**. It is not necessary to change the wireless channel unless you notice interference problems with another nearby access point.
- **Channel Width** - This field determines which operating frequency will be used. It is not necessary to change the wireless channel unless you notice interference problems with another nearby access point. If you select auto, then AP will choose the best channel automatically.
- **Enable SSID Broadcast** - If enabled, the router will broadcast the wireless network name (SSID).

#### 4.6.2. WPS

WPS (Wi-Fi Protected Setup) can help you to quickly and securely connect to a network. This section will guide you to add a new wireless device to your router’s network quickly via WPS.

**Note:**

The WPS function cannot be configured if the wireless function of the router is disabled. Please make sure the wireless function is enabled before configuration.

1. Visit <http://tplinkwifi.net>, and log in with the username and password you set for the router.
2. Go to **Wireless > WPS**.
3. Follow one of the following three methods to connect your client device to the router’s Wi-Fi network.

#### Method ONE: Press the WPS Buttons on the Router and Client Device

For details, refer to [Method 3: Use the WPS button](#) of [Connect Your Router](#).

## Method TWO: Press the WPS Button on Your Client Device

1. Keep the WPS Status as [Enabled](#) and click [Add Device](#).

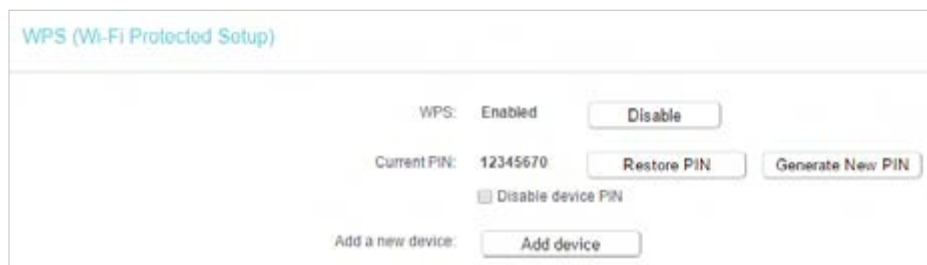

WPS (Wi-Fi Protected Setup)

WPS: Enabled

Current PIN: 12345670

Disable device PIN

Add a new device:

2. Select [Press the WPS button of the new device within the next two minutes](#) and click [Connect](#).

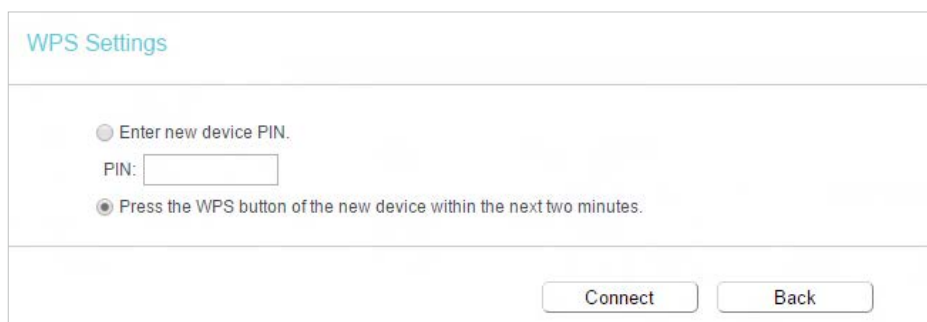

WPS Settings

Enter new device PIN.  
PIN:

Press the WPS button of the new device within the next two minutes.

3. Within two minutes, press the WPS button on your client device.
4. A success message will appear on the WPS page if the client device has been successfully added to the router's network.

## Method THREE: Enter the Client's PIN

1. Keep the WPS Status as [Enabled](#) and click [Add Device](#).

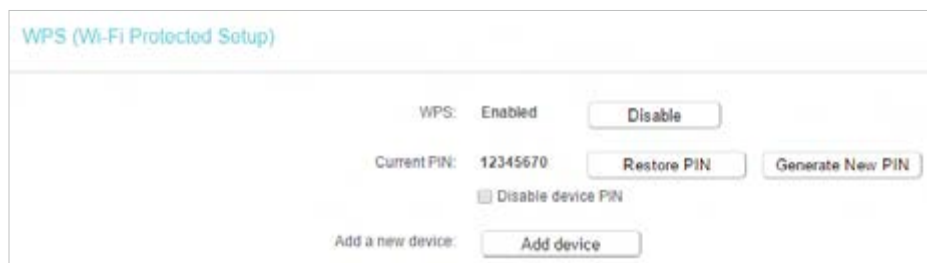

WPS (Wi-Fi Protected Setup)

WPS: Enabled

Current PIN: 12345670

Disable device PIN

Add a new device:

2. Select [Enter new device PIN](#), enter your client device's current PIN in the [PIN](#) field and click [Connect](#).

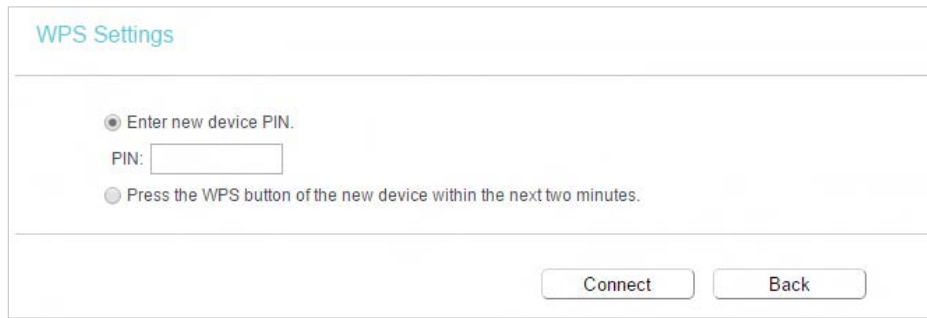

WPS Settings

Enter new device PIN.

PIN:

Press the WPS button of the new device within the next two minutes.

Connect Back

3. A success message will appear on the WPS page if the client device has been successfully added to the router's network.

### Method FOUR: Enter the Router's PIN

1. Keep the WPS Status as **Enabled** and get the **Current PIN** of the router.

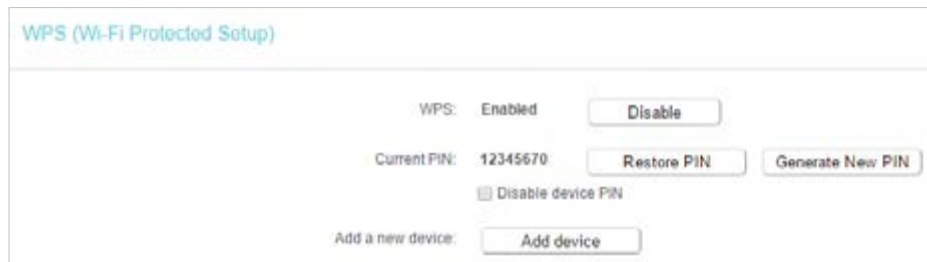

WPS (Wi-Fi Protected Setup)

WPS: Enabled

Current PIN: 12345670

Disable device PIN

Add a new device:

2. Enter the router's current PIN on your client device to join the router's Wi-Fi network.

### 4. 6. 3. Wireless Security

1. Visit <http://tplinkwifi.net>, and log in with the username and password you set for the router.
2. Go to **Wireless > Wireless Security**.
3. Configure the security settings of your wireless network and click **Save**.



Wireless Security Settings

Note: WEP security, WPA/WPA2 - Enterprise authentication and TKIP encryption are not supported with WPS enabled. For network security, it is strongly recommended to enable wireless security and select WPA2-PSK AES encryption.

Disable Wireless Security

WPA/WPA2 - Personal(Recommended)

Authentication Type: WPA2-PSK

Encryption: AES

Wireless Password: 12345670

Group Key Update Period: 0

WPA/WPA2 - Enterprise

Authentication Type: Auto

Encryption: Auto

RADIUS Server IP:

RADIUS Server Port: 1812 (1-65535, 0 stands for default port 1812)

RADIUS Server Password:

Group Key Update Period: 0

WEP

Authentication Type: Open System

WEP Key Format: Hexadecimal

Selected Key: WEP Key

Key	Key Type
Key 1: <input type="radio"/>	Disabled
Key 2: <input type="radio"/>	Disabled
Key 3: <input type="radio"/>	Disabled
Key 4: <input type="radio"/>	Disabled

Save

- **Disable Wireless Security** - The wireless security function can be enabled or disabled. If disabled, wireless clients can connect to the router without a password. It's strongly recommended to choose one of the following modes to enable security.
- **WPA-PSK/WPA2-Personal** - It's the WPA/WPA2 authentication type based on pre-shared passphrase.
  - **Authentication Type** - Select **Auto**, **WPA-PSK** or **WPA2-PSK**.
  - **Encryption** - Select **Auto**, **TKIP** or **AES**.
  - **Wireless Password** - Enter ASCII or Hexadecimal characters. For Hexadecimal, the length should be between 8 and 64 characters; for ASCII, the length should be between 8 and 63 characters.
  - **Group Key Update Period** - Specify the group key update interval in seconds. The value can be 0 or at least 30. Enter 0 to disable the update.
- **WPA /WPA2-Enterprise** - It's based on Radius Server.
  - **Authentication Type** - Select **Auto**, **WPA** or **WPA2**.
  - **Encryption** - Select **Auto**, **TKIP** or **AES**.
  - **Radius Server IP** - Enter the IP address of the Radius server.

- **Radius Server Port** - Enter the port that Radius server used.
- **Radius Server Password** - Enter the password for the Radius server.
- **Group Key Update Period** - Specify the group key update interval in seconds. The value should be 30 or above. Enter 0 to disable the update.
- **WEP** - It is based on the IEEE 802.11 standard.
  - **Authentication Type** - The default setting is **Auto**, which can select **Shared Key** or **Open System** authentication type automatically based on the wireless client's capability and request.
  - **WEP Key Format** - Hexadecimal and ASCII formats are provided here. Hexadecimal format stands for any combination of hexadecimal digits (0-9, a-f, A-F) in the specified length. ASCII format stands for any combination of keyboard characters in the specified length.
  - **WEP Key (Password)** - Select which of the four keys will be used and enter the matching WEP key. Make sure these values are identical on all wireless clients in your network.
  - **Key Type** - Select the WEP key length (64-bit or 128-bit) for encryption. **Disabled** means this WEP key entry is invalid.
  - **64-bit** - Enter 10 hexadecimal digits (any combination of 0-9, a-f and A-F. Null key is not permitted) or 5 ASCII characters.
  - **128-bit** - Enter 26 hexadecimal digits (any combination of 0-9, a-f and A-F. Null key is not permitted) or 13 ASCII characters.

#### 4. 6. 4. Wireless MAC Filtering

Wireless MAC Filtering is used to deny or allow specific wireless client devices to access your network by their MAC addresses.

##### **I want to:**

Deny or allow specific wireless client devices to access my network by their MAC addresses.

**For example**, you want the wireless client A with the MAC address 00-0A-EB-B0-00-0B and the wireless client B with the MAC address 00-0A-EB-00-07-5F to access the router, but other wireless clients cannot access the router

##### **How can I do that?**

1. Visit <http://tplinkwifi.net>, and log in with the username and password you set for the router.

2. Go to [Wireless > Wireless MAC Filtering](#).
3. Click [Enable](#) to enable the Wireless MAC Filtering function.
4. Select [Allow the stations specified by any enabled entries in the list to access](#) as the filtering rule.
5. Delete all or disable all entries if there are any entries already.
6. Click [Add New](#) and fill in the blank.

**Add or Modify Wireless MAC Address Filtering entry**

You can configure Wireless MAC Filtering which allows you to control wireless access on the network on this page.

MAC Address:

Description:

Status:

- 1) Enter the MAC address 00:0A:EB:B0:00:0B or 00:0A:EB:00:07-5F in the MAC Address field.
  - 2) Enter wireless client A/B in the Description field.
  - 3) Select [Enabled](#) in the Status drop-down list.
  - 4) Click [Save](#) and click [Back](#).
7. The configured filtering rules should be listed as the picture shows below.

**Wireless MAC Filtering**

You can configure Wireless MAC Filtering which allows you to control wireless access on the network on this page.

Wireless MAC Filtering:  Enabled  Disable

Filtering Rules

Deny the stations specified by any enabled entries in the list to access.

Allow the stations specified by any enabled entries in the list to access.

<input type="checkbox"/>	MAC Address	Status	Host	Description	Edit
<input checked="" type="checkbox"/>	00:0A:EB:B0:00:0B	Enabled	TP-LINK_TAFF	client A	<a href="#">Edit</a>
<input checked="" type="checkbox"/>	00:0A:EB:00:07:5F	Enabled	TP-LINK_TAFF	Client B	<a href="#">Edit</a>

## Done!

Now only client A and client B can access your network.

### 4.6.5. Wireless Advanced

1. Visit <http://tplinkwifi.net>, and log in with the username and password you set for the router.
2. Go to [Wireless > Wireless Advanced](#).

### 3. Configure the advanced settings of your wireless network and click [Save](#).

#### Note:

If you are not familiar with the setting items on this page, it's strongly recommended to keep the provided default values; otherwise it may result in lower wireless network performance.

**Wireless Advanced**

---

Notice: For better performance, Fragmentation Threshold is disabled when wireless mode include 11n or 11ac.

Transmit Power:	<input type="text" value="High"/>	
Beacon Interval:	<input type="text" value="100"/>	(25-1000)
RTS Threshold:	<input type="text" value="2346"/>	(1-2346)
Fragmentation Threshold:	<input type="text" value="2346"/>	(256-2346)
DTIM Interval:	<input type="text" value="1"/>	(1-255)
	<input checked="" type="checkbox"/> Enable Short GI <input type="checkbox"/> Enable Client Isolation <input checked="" type="checkbox"/> Enable WMM	

- **Transmit Power** - Select [High](#), [Middle](#) or [Low](#) which you would like to specify for the router. [High](#) is the default setting and recommended.
- **Beacon Interval** - Enter a value between 40-1000 milliseconds for Beacon Interval here. Beacon Interval value determines the time interval of the beacons. The beacons are the packets sent by the router to synchronize a wireless network. The default value is 100.
- **RTS Threshold** - Here you can specify the RTS (Request to Send) Threshold. If the packet is larger than the specified RTS Threshold size, the router will send RTS frames to a particular receiving station and negotiate the sending of a data frame. The default value is 2346.
- **Fragmentation Threshold** - This value is the maximum size determining whether packets will be fragmented. Setting a low value for the Fragmentation Threshold may result in poor network performance because of excessive packets. 2346 is the default setting and is recommended.
- **DTIM Interval** - This value determines the interval of the Delivery Traffic Indication Message (DTIM). A DTIM field is a countdown field informing clients of the next window for listening to broadcast and multicast messages. When the router has buffered broadcast or multicast messages for associated clients, it sends the next DTIM with a DTIM Interval value. You can specify the value between 1-255 Beacon Intervals. The default value is 1, which indicates the DTIM Interval is the same as Beacon Interval.
- **Enable Short GI** - It is recommended to enable this function, for it will increase the data capacity by reducing the guard interval time.

- **Enable Client Isolation** - This function isolates all connected wireless stations so that wireless stations cannot access each other through WLAN.
- **Enable WMM** - WMM function can guarantee the packets with high-priority messages being transmitted preferentially. It is strongly recommended to enable this function.

#### 4.6.6. Wireless Statistics

1. Visit <http://tplinkwifi.net>, and log in with the username and password you set for the router.
2. Go to **Wireless > Wireless Statistics** to check the data packets sent and received by each client device connected to the router.

ID	MAC Address	Current Status	Received Packets	Sent Packets	SSID
1	44:00:10:8F:3B:A7	Associated	29	19	TP-LINK_108F3BA7

- **MAC Address** - The MAC address of the connected wireless client.
- **Current Status** - The running status of the connected wireless client.
- **Received Packets** - Packets received by the wireless client.
- **Sent Packets** - Packets sent by the wireless client.
- **SSID** - SSID that the station associates with.

#### 4.7. Guest Network

Guest Network allows you to provide Wi-Fi access for guests without disclosing your host network. When you have guests in your house, apartment, or workplace, you can create a guest network for them. In addition, you can customize guest network settings to ensure network security and privacy.

1. Visit <http://tplinkwifi.net>, and log in with the username and password you set for the router.
2. Go to **Guest Network**.
3. Enable the **Guest Network** function.
4. Create a network name for your guest network.
5. Select the **Security** type and create the **Password** of the guest network.
6. Select **Schedule** from the **Access Time** drop-down list and customize it for the guest network.

7. Click [Save](#).

- [Allow Guest To Access My Local Network](#) - If enabled, guests can access the local network and manage it.
- [Guest Network Isolation](#) - If enabled, guests are isolated from each other.
- [Enable Guest Network Bandwidth Control](#) - If enabled, the Guest Network Bandwidth Control rules will take effect.

**Note:** The range of bandwidth for guest network is calculated according to the setting of Bandwidth Control on the [Bandwidth Control](#) page.

## 4.8. DHCP

By default, the DHCP (Dynamic Host Configuration Protocol) Server is enabled and the router acts as a DHCP server; it dynamically assigns TCP/IP parameters to client devices from the IP Address Pool. You can change the settings of DHCP Server if necessary, and you can reserve LAN IP addresses for specified client devices.

### 4.8.1. DHCP Settings

1. Visit <http://tplinkwifi.net>, and log in with the username and password you set for the router.
2. Go to **DHCP > DHCP Settings**.
3. Specify DHCP server settings and click **Save**.

DHCP Settings

DHCP Server:  Disable  Enable

Start IP Address: 192.168.0.100

End IP Address: 192.168.0.199

Lease Time: 120 minutes (1-2880 minutes, the default value is 120)

Default Gateway: 192.168.0.1 (optional)

Default Domain: (optional)

DNS Server: 0.0.0.0 (optional)

Secondary DNS Server: 0.0.0.0 (optional)

Save

- **DHCP Server** - Enable or disable the DHCP server. If disabled, you must have another DHCP server within your network or else you must configure the computer manually.
- **Start IP Address** - Specify an IP address for the DHCP Server to start with when assigning IP addresses. 192.168.0.100 is the default start address.
- **End IP Address** - Specify an IP address for the DHCP Server to end with when assigning IP addresses. 192.168.0.199 is the default end address.
- **Address Lease Time** - The Address Lease Time is the amount of time a network user will be allowed to connect to the router with the current dynamic IP Address. When time is up, the user will be automatically assigned a new dynamic IP address. The range of the time is 1 ~ 2880 minutes. The default value is 120.
- **Default Gateway (Optional)** - It is suggested to input the IP address of the LAN port of the router. The default value is 192.168.0.1.
- **Default Domain (Optional)** - Input the domain name of your network.
- **DNS Server (Optional)** - Input the DNS IP address provided by your ISP.
- **Secondary DNS Server (Optional)** - Input the IP address of another DNS server if your ISP provides two DNS servers.

**Note:**

- To use the DHCP server function of the router, you must configure all computers on the LAN as **Obtain an IP Address automatically**.

### 4. 8. 2. DHCP Client List

1. Visit <http://tplinkwifi.net>, and log in with the username and password you set for the router.
2. Go to **DHCP > DHCP Client List** to view the information of the clients connected to the router.

ID	Client Name	MAC Address	Assigned IP	Lease Time
1	Camille	40:8D:5C:89:74:B5	192.168.0.100	00:00:32
2	iPhone	34:E2:FD:14:1D:0D	192.168.0.101	00:00:55

- **Client Name** - The name of the DHCP client.
- **MAC Address** - The MAC address of the DHCP client.
- **Assigned IP** - The IP address that the router has allocated to the DHCP client.
- **Lease Time** - The time of the DHCP client leased. After the dynamic IP address has expired, a new dynamic IP address will be automatically assigned to the user.

You cannot change any of the values on this page. To update this page and show the current attached devices, click [Refresh](#).

### 4. 8. 3. Address Reservation

You can reserve an IP address for a specific client. When you specify a reserved IP address for a PC on the LAN, this PC will always receive the same IP address each time when it accesses the DHCP server.

1. Visit <http://tplinkwifi.net>, and log in with the username and password you set for the router.
2. Go to **DHCP > Address Reservation**.
3. Click [Add New](#) and fill in the blank.

<input type="checkbox"/>	MAC Address	IP Address	Status	Edit
<input type="checkbox"/>	40:8D:5C:89:74:B5	192.168.0.100	Disabled	<a href="#">Edit</a>

- 1) Enter the MAC address (in XX:XX:XX:XX:XX:XX format.) of the client for which you want to reserve an IP address.



- 2) Enter the IP address (in dotted-decimal notation) which you want to reserve for the client.
- 3) Leave the **Status** as **Enabled**.
- 4) Click **Save**.

## 4.9. Forwarding

The router's NAT (Network Address Translation) feature makes the devices on the LAN use the same public IP address to communicate in the internet, which protects the local network by hiding IP addresses of the devices. However, it also brings about the problem that external hosts cannot initiatively communicate with the specified devices in the local network.

With the forwarding feature, the router can traverse the isolation of NAT so that clients on the internet can reach devices on the LAN and realize some specific functions.

The TP-Link router includes four forwarding rules. If two or more rules are set, the priority of implementation from high to low is Virtual Servers, Port Triggering, UPNP and DMZ.

### 4.9.1. Virtual Server

When you build up a server in the local network and want to share it on the internet, Virtual Servers can realize the service and provide it to internet users. At the same time virtual servers can keep the local network safe as other services are still invisible from the internet.

Virtual Servers can be used to set up public services in your local network, such as HTTP, FTP, DNS, POP3/SMTP and Telnet. Different service uses different service port. Port 80 is used in HTTP service, port 21 in FTP service, port 25 in SMTP service and port 110 in POP3 service. Please verify the service port number before the configuration.

#### I want to:

Share my personal website I've built in local network with my friends through the internet.

**For example**, the personal website has been built in my home PC (192.168.0.100). I hope that my friends on the internet can visit my website in some way. My PC is connected to the router with the WAN IP address 218.18.232.154.

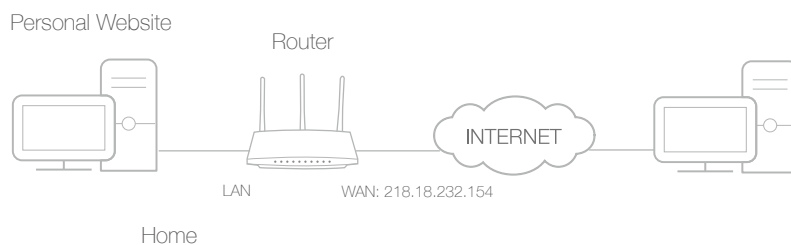

## How can I do that?

1. Set your PC to a static IP address, for example 192.168.0.100.
2. Visit <http://tplinkwifi.net>, and log in with the username and password you set for the router.
3. Go to [Forwarding > Virtual Server](#).
4. Click [Add New](#). Select [HTTP](#) from the [Common Service Port](#) list. The service port, internal port and protocol will be automatically filled in. Enter the PC's IP address 192.168.0.100 in the [IP Address](#) field.

5. Leave the status as [Enabled](#) and click [Save](#).

**Note:**

- It is recommended to keep the default settings of [Internal Port](#) and [Protocol](#) if you are not clear about which port and protocol to use.
- If the service you want to use is not in the [Common Service Port](#) list, you can enter the corresponding parameters manually. You should verify the port number that the service needs.
- You can add multiple virtual server rules if you want to provide several services in a router. Please note that the [Service Port](#) should not be overlapped.

## Done!

Users on the internet can enter [http:// WAN IP](#) (in this example: [http:// 218.18.232.154](#)) to visit your personal website.

**Note:**

- If you have changed the default [Service Port](#), you should use [http:// WAN IP: Service Port](#) to visit the website.
- Some specific service ports are forbidden by the ISP. If you fail to visit the website, please use another service port.

### 4.9.2. Port Triggering

Port triggering can specify a triggering port and its corresponding external ports. When a host in the local network initiates a connection to the triggering port, all the external ports will be opened for subsequent connections. The router can record the IP address of the host. When the data from the internet return to the external ports, the router can forward them to the corresponding host. Port triggering is mainly applied to online games, VoIPs, video players and common applications including MSN Gaming Zone, Dialpad, Quick Time 4 players and more.

Follow the steps below to configure the port triggering rules:

1. Visit <http://tplinkwifi.net>, and log in with the username and password you set for the router.
2. Go to **Forwarding > Port Triggering**.
3. Click **Add New**. Select the desired application from the **Common Applications** list. The trigger port and incoming ports will be automatically filled in. The following picture takes application **MSN Gaming Zone** as an example.

The screenshot shows the 'Port Trigger' configuration interface. It includes the following fields and values:

- Trigger Port: 47624 (XX)
- Trigger Protocol: ALL
- Open Port: 2300-2400,28800-29 (XX or XX-XX or XX-XX,XX)
- Open Protocol: ALL
- Status: Enabled
- Common Service Port: MSN Gaming Zone

At the bottom of the form, there are two buttons: 'Save' and 'Back'.

4. Leave the status as **Enabled** and click **Save**.

**Note:**

- You can add multiple port triggering rules as needed.
- The triggering ports can not be overlapped.
- If the application you need is not listed in the **Common Applications** list, please enter the parameters manually. You should verify the incoming ports the application uses first and enter them in **Open Port** field. You can input at most 5 groups of ports (or port sections). Every group of ports must be set apart with ",". For example, 2000-2038, 2050-2051, 2085, 3010-3030.

### 4.9.3. DMZ

When a PC is set to be a DMZ (Demilitarized Zone) host in the local network, it is totally exposed to the internet, which can realize the unlimited bidirectional communication between internal hosts and external hosts. The DMZ host becomes a virtual server with all ports opened. When you are not clear about which ports to open in some special applications, such as IP camera and database software, you can set the PC to be a DMZ host.

**Note:**

DMZ is more applicable in the situation that users are not clear about which ports to open. When it is enabled, the DMZ host is totally exposed to the internet, which may bring some potential safety hazards. If DMZ is not in use, please disable it in time.

### I want to:

Make the home PC join the internet online game without port restriction.

**For example**, due to some port restriction, when playing the online games, you can log in normally but cannot join a team with other players. To solve this problem, set your PC as a DMZ host with all ports opened.

## How can I do that?

1. Assign a static IP address to your PC, for example 192.168.0.100.
2. Visit <http://tplinkwifi.net>, and log in with the username and password you set for the router.
3. Go to **Forwarding > DMZ**.
4. Select **Enable** and enter the IP address 192.168.0.100 in the **DMZ Host IP Address** field.

5. Click **Save**.

## Done!

You've set your PC to a DMZ host and now you can make a team to game with other players.

### 4.9.4. UPnP

The UPnP (Universal Plug and Play) protocol allows the applications or host devices to automatically find the front-end NAT device and send request to it to open the corresponding ports. With UPnP enabled, the applications or host devices on the local network and the internet can freely communicate with each other realizing the seamless connection of the network. You may need to enable the UPnP if you want to use applications for multiplayer gaming, peer-to-peer connections, real-time communication (such as VoIP or telephone conference) or remote assistance, etc.

#### ☞ Tips:

- UPnP is enabled by default in this router.
- Only the application supporting UPnP protocol can use this feature.
- UPnP feature needs the support of operating system (e.g. Windows Vista/ Windows 7/ Windows 8, etc. Some of operating system need to install the UPnP components).

For example, when you connect your Xbox to the router which is connected to the internet to play online games, UPnP will send request to the router to open the corresponding ports allowing the following data penetrating the NAT to transmit. Therefore, you can play Xbox online games without a hitch.

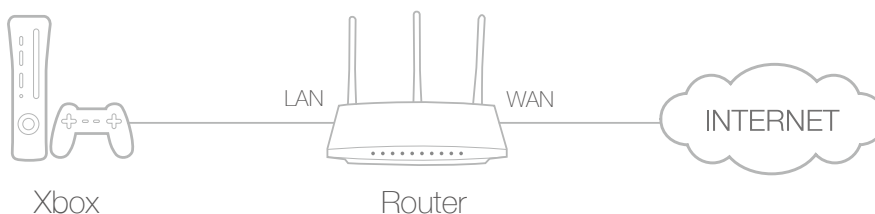

If necessary, you can follow the steps to change the status of UPnP.

1. Visit <http://tplinkwifi.net>, and log in with the username and password you set for the router.
2. Go to **Forwarding > UPnP**.
3. Click **Disable** or **Enable** according to your needs.



## 4. 10. Security

This function allows you to protect your home network from cyber attacks and unauthorized users by implementing these network security functions.

### 4. 10. 1. Basic Security

1. Visit <http://tplinkwifi.net>, and log in with the username and password you set for the router.
2. Go to **Security > Basic Security**, and you can enable or disable the security functions.

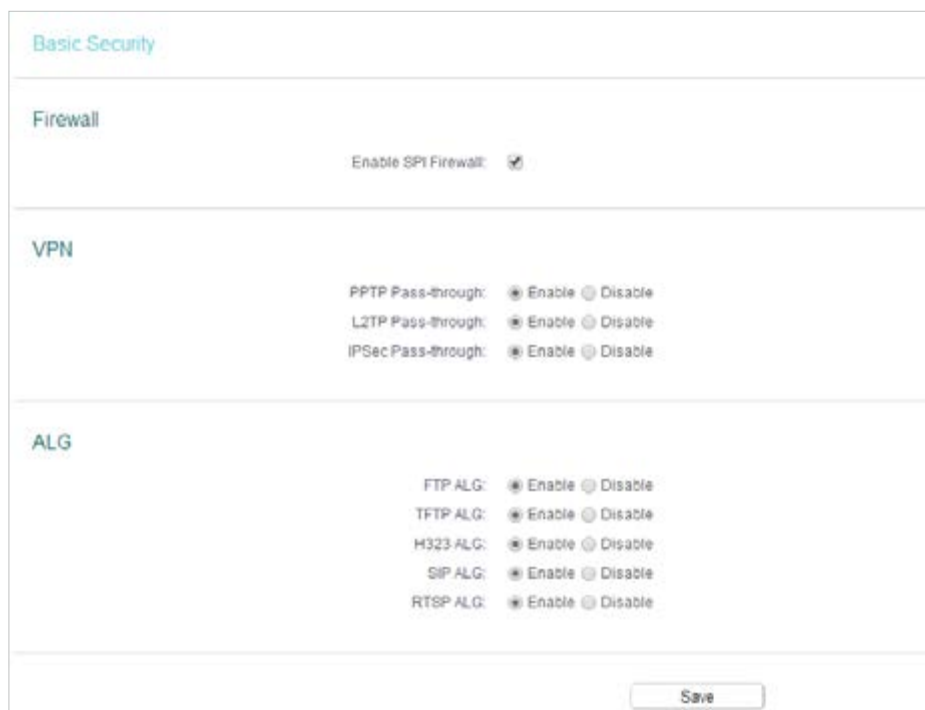

- **Firewall** - A firewall protects your network from internet attacks.
  - **Enable SPI Firewall** - SPI (Stateful Packet Inspection, also known as dynamic packet filtering) helps to prevent cyber attacks by tracking more state per session. It validates that the traffic passing through the session conforms to the protocol. SPI Firewall is enabled by default.
- **VPN** - VPN Passthrough must be enabled if you want to allow VPN tunnels using IPSec, PPTP or L2TP protocols to pass through the router's firewall.
  - **PPTP Passthrough** - Point-to-Point Tunneling Protocol (PPTP) allows the Point-to-Point Protocol (PPP) to be tunneled through an IP network. If you want to allow PPTP tunnels to pass through the router, you can keep the default (Enabled).
  - **L2TP Passthrough** - Layer 2 Tunneling Protocol (L2TP) is the method used to enable Point-to-Point sessions via the internet on the Layer 2 level. If you want to allow L2TP tunnels to pass through the router, you can keep the default (Enabled).
  - **IPSec Passthrough** - Internet Protocol Security (IPSec) is a suite of protocols for ensuring private, secure communications over Internet Protocol (IP) networks, through the use of cryptographic security services. If you want to allow IPSec tunnels to pass through the router, you can keep the default (Enabled).
- **ALG** - It is recommended to enable Application Layer Gateway (ALG) because ALG allows customized Network Address Translation (NAT) traversal filters to be plugged into the gateway to support address and port translation for certain application layer "control/data" protocols such as FTP, TFTP, H323 etc.
  - **FTP ALG** - To allow FTP clients and servers to transfer data across NAT, keep the default **Enable**.
  - **TFTP ALG** - To allow TFTP clients and servers to transfer data across NAT, keep the default **Enable**.
  - **H323 ALG** - To allow Microsoft NetMeeting clients to communicate across NAT, keep the default **Enable**.
  - **SIP ALG** - To allow some multimedia clients to communicate across NAT, click **Enable**.
  - **RTSP ALG** - To allow some media player clients to communicate with some streaming media servers across NAT, click **Enable**.

3. Click **Save**.

## 4. 10. 2. Advanced Security

1. Visit <http://tplinkwifi.net>, and log in with the username and password you set for the router.

2. Go to [Security > Advanced Security](#), and you can protect the router from being attacked by ICMP-Flood, UDP Flood and TCP-SYN Flood.

- **DoS Protection** - Denial of Service protection. Select Enable or Disable to enable or disable the DoS protection function. Only when it is enabled, will the flood filters be enabled.

**Note:**

Dos Protection will take effect only when the Statistics in [System Tool > Statistics](#) is enabled.

- **Enable ICMP-FLOOD Attack Filtering** - Check the box to enable or disable this function.
- **ICMP-FLOOD Packets Threshold (5~3600)** - The default value is 50. Enter a value between 5 ~ 3600. When the number of the current ICMP-FLOOD packets is beyond the set value, the router will startup the blocking function immediately.
- **Enable UDP-FLOOD Filtering** - Check the box to enable or disable this function.
- **UDP-FLOOD Packets Threshold (5~3600)** - The default value is 500. Enter a value between 5 ~ 3600. When the number of the current UPD-FLOOD packets is beyond the set value, the router will startup the blocking function immediately.
- **Enable TCP-SYN-FLOOD Attack Filtering** - Check the box to enable or disable this function.
- **TCP-SYN-FLOOD Packets Threshold (5~3600)** - The default value is 50. Enter a value between 5 ~ 3600. When the number of the current TCP-SYN-FLOOD packets is beyond the set value, the router will startup the blocking function immediately.
- **Forbid Ping Packet From WAN Port** - The default setting is enable. If disabled, the ping packet from the internet can access the router.
- **Forbid Ping Packet From LAN Port** - The default setting is disabled. If enabled, the ping packet from LAN cannot access the router. This function can be used to defend against some viruses.

3. Click [Save](#).
4. Click [Blocked DoS Host List](#) to display the DoS host table by blocking.

## 4.11. Parental Controls

Parental Controls allows you to block inappropriate and malicious websites, and control access to specific websites at specific time for your children's devices.

For example, you want the children's PC with the MAC address 00-11-22-33-44-AA can access [www.tp-link.com](http://www.tp-link.com) on Saturday only while the parent PC with the MAC address 00-11-22-33-44-BB is without any restriction.

1. Visit <http://tplinkwifi.net>, and log in with the username and password you set for the router.
2. Go to [Parental Controls](#).
3. Check the [Enable Parental Controls](#) box and enter the MAC address 00:11:22:33:44:BB in the MAC Address of Parental PC field.
4. Enter 00:11:22:33:44:AA in the [MAC Address 1](#) field.
5. Create a new schedule with Day is Sat and Time is all day-24 hours. Click [Add](#)
6. Enter [www.tp-link.com](http://www.tp-link.com) in the [Add URL](#) field. Click [Add](#).
7. Click [Save](#).

Then you will see the page as shown in figure below.



## 4. 12. Access Control

Access Control is used to deny or allow specific client devices to access your network with access time and content restrictions.

### I want to:

Deny or allow specific client devices to access my network with access time and content restrictions.

**For example,** If you want to restrict the internet activities of host with MAC address 00-11-22-33-44-AA on the LAN to access [www.tp-link.com](http://www.tp-link.com) only, please follow the steps below:

### How can I do that?

1. Visit <http://tplinkwifi.net>, and log in with the username and password you set for the router.
2. Go to **Access Control > Host** and configure the host settings:
  - 1) Click **Add New**.
  - 2) Select **MAC Address** as the mode type. Create a unique description (e.g. **host\_1**) for the host in the **Description** field and enter 00-11-22-33-44-AA in the **MAC Address** field.

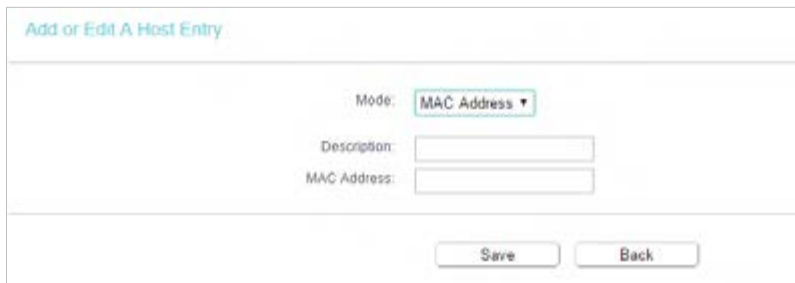

- 3) Click **Save**.
3. Go to **Access Control > Target** and configure the target settings:
  - 1) Click **Add New**.
  - 2) Select **URL Address** as the mode type. Create a unique description (e.g. **target\_1**) for the target in the **Target Description** field and enter the domain name, either the full name or the keywords (for example TP-Link) in the **Add URL Address** field.

**Note:**

Any URL address with keywords in it (e.g. [www.tp-link.com](http://www.tp-link.com)) will be blocked or allowed.

- 3) Click [Save](#).
4. Go to [Access Control](#) > [Schedule](#) and configure the schedule settings:
  - 1) Click [Add New](#).
  - 2) Create a unique description (e.g. [schedule\\_1](#)) for the schedule in the [Schedule Description](#) field and set the day(s) and time period.

- 3) Click [Save](#).
5. Go to [Access Control](#) > [Rule](#) and add a new access control rule.
  - 1) Click [Add New](#).
  - 2) Give a name for the rule in the [Description](#) field. Select [host\\_1](#) from the LAN host drop-down list; select [target\\_1](#) from the target drop-down list; select [schedule\\_1](#) from the schedule drop-down list.

**Add Internet Access Control Entry**

Description:

LAN Host:  [Add LAN Host](#)

Target:  [Add Target](#)

Schedule:  [Add Schedule](#)

Rule:

Status:

Direction:

- 3) Leave the status as **Enabled** as click **Save**.
6. Select **Enable Internet Access Control** to enable Access Control function.
7. Select **Allow the packets specified by any enabled access control policy to pass through the Router as the default filter policy** and click **Save**.

**Access Control Rule Management**

This device can restrict internet activity for specified LAN hosts. You can set and combine access control rules to effectively manage your network.

Enable Internet access control

Default Filtering Rules:

Allow the packets not specified by any filtering rules to pass through this device

Deny the packets not specified by any filtering rules to pass through this device

## Done!

Now only the specific host(s) can visit the target(s) within the scheduled time period.

## 4. 13. Advanced Routing

Static Routing is a form of routing that is configured manually by a network administrator or a user by adding entries into a routing table. The manually-configured routing information guides the router in forwarding data packets to the specific destination.

### 4. 13. 1. Static Route List

1. Visit <http://tplinkwifi.net>, and log in with the username and password you set for the router.
2. Go to **Advanced Routing > Static Route List**.

#### ➤ To add static routing entries:

1. Click **Add New**.

Static Route

---

Destination IP Address:

Subnet Mask:

Gateway:

Interface:  (optional)

Status:

---

2. Enter the following information.

- **Destination IP Address** - The Destination Network is the address of the network or host that you want to assign to a static route.
- **Subnet Mask** - The Subnet Mask determines which portion of an IP address is the network portion, and which portion is the host portion.
- **Gateway** - This is the IP address of the default gateway device that allows the contact between the router and the network or host.

3. Select **Enabled** or **Disabled** for this entry on the **Status** drop-down list.

4. Click **Save**.

You can also do the following operations to modify the current settings.

- Click **Delete** to delete the entry.
- Click **Enable Selected** to enable all the entries.
- Click **Disable Selected** to disable all the entries.
- Click **Delete Selected** to delete all the entries.

#### 4. 13. 2. System Routing Table

1. Visit <http://tplinkwifi.net>, and log in with the username and password you set for the router.

2. Go to **Advanced Routing > System Routing Table**, and you can view all the valid route entries in use.

System Routing Table

---

ID	Destination Network	Subnet Mask	Gateway	Interface
1	192.168.0.0	255.255.255.0	0.0.0.0	LAN & WLAN

---

- **Destination Network** - The Destination Network is the address of the network or host to which the static route is assigned.
- **Subnet Mask** - The Subnet Mask determines which portion of an IP address is the network portion, and which portion is the host portion.
- **Gateway** - This is the IP address of the gateway device that allows for contact between the Router and the network or host.
- **Interface** - This interface tells you whether the Destination IP Address is on the LAN & WLAN (internal wired and wireless networks), or the WAN (Internet).
- Click **Refresh** to refresh the data displayed.

## 4. 14. Bandwidth Control

### 4. 14. 1. Control Settings

1. Visit <http://tplinkwifi.net>, and log in with the username and password you set for the router.
2. Go to **Bandwidth Control**.
3. Configure the bandwidth as needed and click **Save**.



**Bandwidth Control**

Enable Bandwidth Control

Egress Bandwidth:  Kbps

Ingress Bandwidth:  Kbps

The values you configure for the Egress Bandwidth and Ingress Bandwidth should be less than 100,000Kbps. For optimal control of the bandwidth, please select the right Line Type and consult your ISP for the total egress and ingress bandwidth.

- **Enable Bandwidth Control** - Check this box so that the Bandwidth Control settings can take effect.
- **Egress Bandwidth** - The upload speed through the WAN port.
- **Ingress Bandwidth** - The download speed through the WAN port.

### 4. 14. 2. Rule List

1. Visit <http://tplinkwifi.net>, and log in with the username and password you set for the router.
2. Go to **Bandwidth Control** and you can view and configure the Bandwidth Control rules.

Bandwidth Control Rules								
	Description	Priority	Egress Bandwidth		Ingress Bandwidth		Status	Edit
			Min	Max	Min	Max		
<input type="button" value="Add New"/> <input type="button" value="Enable Selected"/> <input type="button" value="Disable Selected"/> <input type="button" value="Delete Selected"/>								

- **Description** - This is the information about the rules such as address range.
- **Egress Bandwidth** - This field displays the max and min upload bandwidth through the WAN port. The default is 0.
- **Ingress Bandwidth** - This field displays the max and min download bandwidth through the WAN port. The default is 0.
- **Status** - This field displays the status of the rule.
- **Modify** - Click **Modify/Delete** to edit/delete the rule.

➤ **To add a Bandwidth control rule:**

1. Click **Add New**.
2. Enter the information as the figure shown below.

Bandwidth Control										
Enable:	<input checked="" type="checkbox"/>									
IP Range:	<input type="text"/> - <input type="text"/>									
Port Range:	<input type="text"/> - <input type="text"/>									
Protocol:	ALL ▾									
Priority:	5 ▾ (1 meaning highest priority)									
	<table border="0"> <tr> <td></td> <td>Min Bandwidth(Kbps)</td> <td>Max Bandwidth(Kbps)</td> </tr> <tr> <td>Egress Bandwidth:</td> <td><input type="text"/></td> <td><input type="text"/></td> </tr> <tr> <td>Ingress Bandwidth:</td> <td><input type="text"/></td> <td><input type="text"/></td> </tr> </table>		Min Bandwidth(Kbps)	Max Bandwidth(Kbps)	Egress Bandwidth:	<input type="text"/>	<input type="text"/>	Ingress Bandwidth:	<input type="text"/>	<input type="text"/>
	Min Bandwidth(Kbps)	Max Bandwidth(Kbps)								
Egress Bandwidth:	<input type="text"/>	<input type="text"/>								
Ingress Bandwidth:	<input type="text"/>	<input type="text"/>								
<input type="button" value="Save"/> <input type="button" value="Back"/>										

3. Click **Save**.

## 4. 15. IP & MAC Binding

IP & MAC Binding, namely, ARP (Address Resolution Protocol) Binding, is used to bind a network device's IP address to its MAC address. This will prevent ARP spoofing and other ARP attacks by denying network access to a device with a matching IP address in the ARP list, but with an unrecognized MAC address.

### 4. 15. 1. Binding Settings

1. Visit <http://tplinkwifi.net>, and log in with the username and password you set for the router.
2. Go to **IP & MAC Binding** > **Binding Settings**.
3. Select **Enable** for ARP Binding.

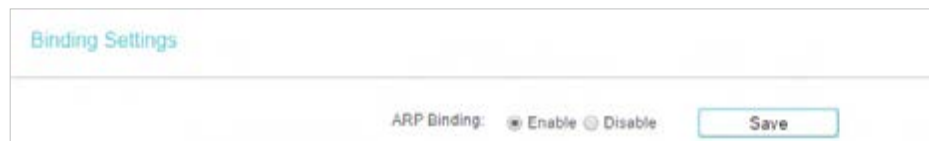

The screenshot shows the 'Binding Settings' page. At the top, the title 'Binding Settings' is displayed. Below the title, there is a section for 'ARP Binding' with two radio buttons: 'Enable' (which is selected) and 'Disable'. To the right of these radio buttons is a 'Save' button.

4. Click **Save**.

➤ **To add IP & MAC Binding entries:**

1. Click **Add New**.
2. Select the **Bind** checkbox.

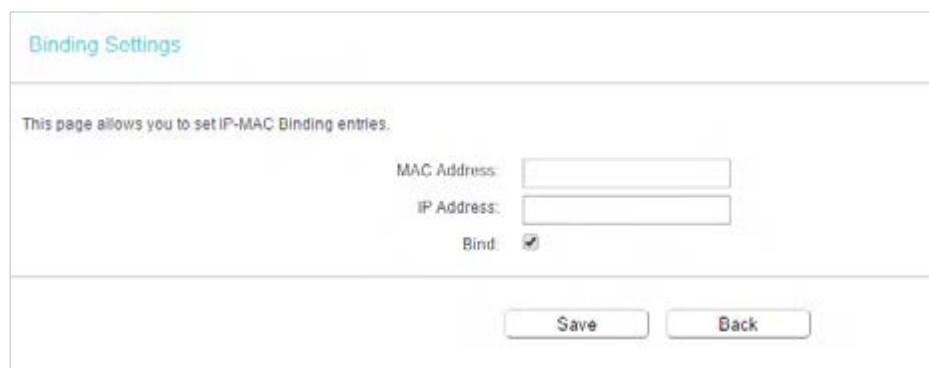

The screenshot shows the 'Binding Settings' page with the following form fields: 'MAC Address' (text input), 'IP Address' (text input), and 'Bind' (checkbox, which is checked). Below the form fields are two buttons: 'Save' and 'Back'.

3. Enter the MAC address and IP address.
4. Click **Save**.

➤ **To modify or delete an existing entry:**

1. Select the desired entry in the table.
2. Click **Edit** or **Delete Selected**.

### 4. 15. 2. ARP List

To manage a device, you can observe the device on the LAN by checking its MAC address and IP address on the ARP list, and you can also configure the items. This page displays the ARP list which shows all the existing IP & MAC Binding entries.

MAC Address	IP Address	Status
00 ED 4C 00 07 BE	192.168.0.4	Bound
40 8D 5C 89 74 B5	192.168.0.100	Unloaded

Buttons: Load Selected, Delete Selected, Refresh

- **MAC Address** - The MAC address of the listed computer on the LAN.
- **IP Address** - The assigned IP address of the listed computer on the LAN.
- **Status** - Indicates whether or not the MAC and IP addresses are bound.
- **Configure** - Load or delete an item.
  - **Load** - Load the item to the IP & MAC Binding list.
  - **Delete** - Delete the item.
- Click the **Load Selected** button to load the selected items to the IP & MAC Binding list.
- Click the **Delete Selected** button to delete the selected items to the IP & MAC Binding list.
- Click the **Refresh** button to refresh all items.

**Note:**

An item can not be loaded to the IP & MAC Binding list if the IP address of the item has been loaded before. Error warning will prompt as well.

## 4. 16. Dynamic DNS

The router offers the DDNS (Dynamic Domain Name System) feature, which allows the hosting of a website, FTP server, or e-mail server with a fixed domain name (named by yourself) and a dynamic IP address. Thus your friends can connect to your server by entering your domain name no matter what your IP address is. Before using this feature, you need to sign up for DDNS service providers such as [www.comexe.cn](http://www.comexe.cn), [www.dyndns.org](http://www.dyndns.org), or [www.noip.com](http://www.noip.com). The Dynamic DNS client service provider will give you a password or key.

1. Visit <http://tplinkwifi.net>, and log in with the username and password you set for the router.
2. Go to **Dynamic DNS**.

### Dyndns DDNS

If the dynamic DNS Service Provider you select is [www.dyn.com](http://www.dyn.com), the following page will appear.



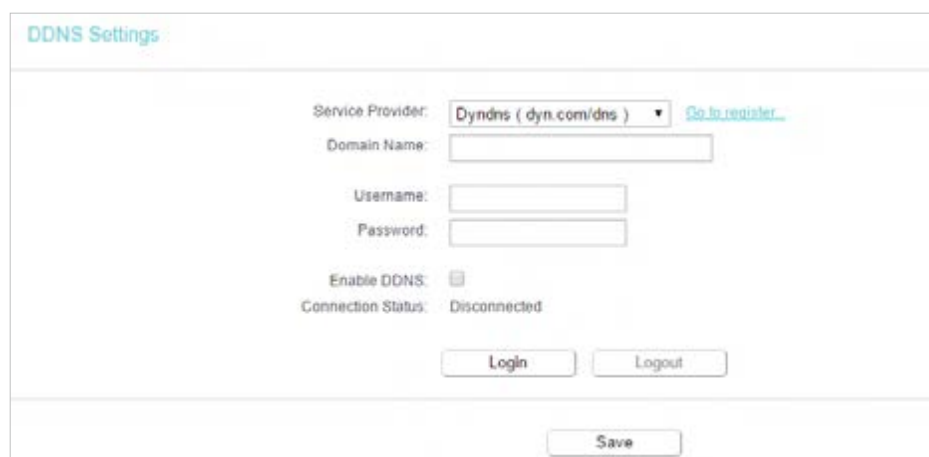

The screenshot shows the 'DDNS Settings' page. At the top, the title 'DDNS Settings' is displayed. Below it, there is a form with the following fields and controls:

- Service Provider:** A dropdown menu set to 'DynDNS ( dyn.com/dns )' with a link 'Go to register...' next to it.
- Domain Name:** An empty text input field.
- Username:** An empty text input field.
- Password:** An empty text input field.
- Enable DDNS:** A checkbox that is currently unchecked.
- Connection Status:** Displays 'Disconnected'.
- Buttons:** 'Login' and 'Logout' buttons are positioned below the connection status. A 'Save' button is located at the bottom center of the form area.

To set up for DDNS, follow these instructions:

1. Enter the [Domain Name](#) you received from dynamic DNS service provider here.
  2. Enter the [Username](#) for your DDNS account.
  3. Enter the [Password](#) for your DDNS account.
  4. Click [Login](#).
  5. Click [Save](#).
- [Connection Status](#) - The status of the DDNS service connection is displayed here.
  - [Logout](#) - Click [Logout](#) to log out of the DDNS service.

## No-ip DDNS

If the dynamic DNS Service Provider you select is [www.noip.com](http://www.noip.com), the following page will appear.

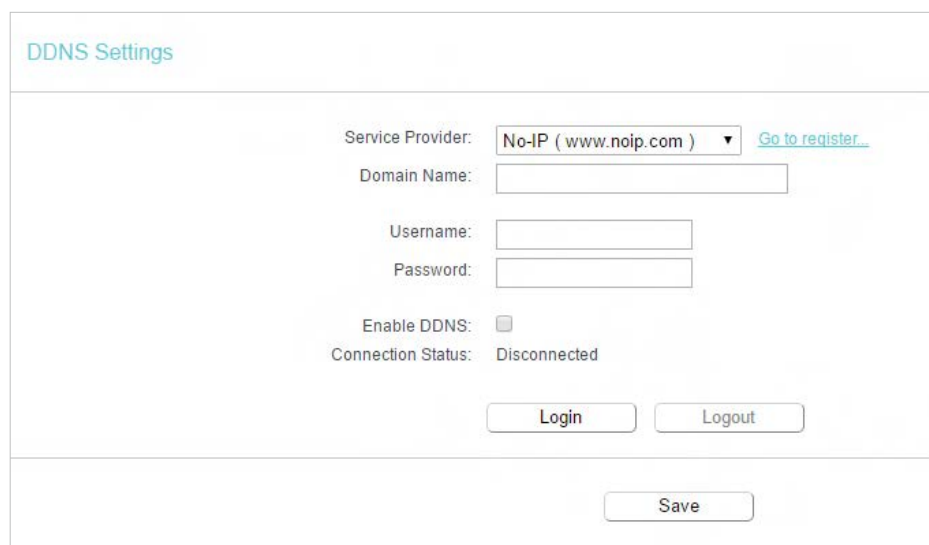

The screenshot shows the 'DDNS Settings' page for No-IP. The layout is similar to the previous screenshot, but with the following differences:

- Service Provider:** The dropdown menu is set to 'No-IP ( www.noip.com )' with a link 'Go to register...' next to it.
- Domain Name:** An empty text input field.
- Username:** An empty text input field.
- Password:** An empty text input field.
- Enable DDNS:** A checkbox that is currently unchecked.
- Connection Status:** Displays 'Disconnected'.
- Buttons:** 'Login' and 'Logout' buttons are positioned below the connection status. A 'Save' button is located at the bottom center of the form area.

To set up for DDNS, follow these instructions:

1. Enter the [Domain Name](#) you received from dynamic DNS service provider.

2. Enter the [Username](#) for your DDNS account.

3. Enter the [Password](#) for your DDNS account.

4. Click [Login](#).

5. Click [Save](#).

- [Connection Status](#) - The status of the DDNS service connection is displayed here.

- [Logout](#) - Click [Logout](#) to log out of the DDNS service.

## Comexe DDNS

If the dynamic DNS Service Provider you select is [www.comexe.cn](http://www.comexe.cn), the following page will appear.

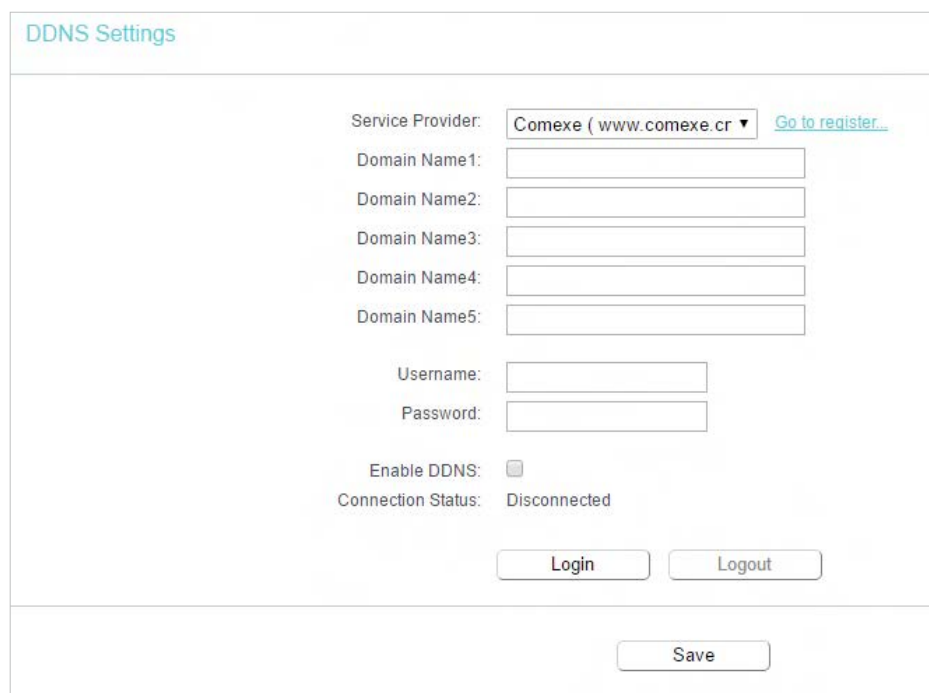

The screenshot shows the 'DDNS Settings' page. At the top, the title 'DDNS Settings' is displayed in a light blue font. Below the title, the 'Service Provider' is set to 'Comexe ( www.comexe.cn )' with a dropdown arrow and a 'Go to register...' link. There are five input fields for 'Domain Name1' through 'Domain Name5'. Below these are input fields for 'Username' and 'Password'. The 'Enable DDNS' checkbox is unchecked. The 'Connection Status' is 'Disconnected'. At the bottom, there are 'Login' and 'Logout' buttons, and a 'Save' button at the very bottom.

To set up for DDNS, follow these instructions:

1. Enter the [Domain Name](#) received from your dynamic DNS service provider.

2. Enter the [Username](#) for your DDNS account.

3. Enter the [Password](#) for your DDNS account.

4. Click [Login](#).

5. Click [Save](#).

- [Connection Status](#) - The status of the DDNS service connection is displayed here.

- [Logout](#) - Click [Logout](#) to log out of the DDNS service.

## 4. 17. IPv6

This function allows you to enable IPv6 function and set up the parameters of the router's Wide Area Network (WAN) and Local Area Network (LAN).

### 4. 17. 1. IPv6 Status

1. Visit <http://tplinkwifi.net>, and log in with the username and password you set for the router.
2. Go to **IPv6 > IPv6 Status**, and you can view the current IPv6 status information of the router.

IPv6 Status	
WAN	
Connection Type:	Dynamic IPv6
Connection Status:	Connecting
IPv6 Address:	:: /0
IPv6 Default Gateway:	Auto
Primary IPv6 DNS:	::
Secondary IPv6 DNS:	::
IPv6 LAN	
IPv6 Address Type:	RADVD
Prefix Length:	64
IPv6 Address:	N/A

- **WAN** - This section shows the current IPv6 information of the router's WAN port, including **Connection Type**, **IPv6 Address** information, **IPv6 Default Gateway**, **Primary IPv6 DNS** and **Secondary IPv6 DNS**.
- **IPv6 LAN** - This section shows the current IPv6 information of the router's LAN port, including **IPv6 Address Assign Type**, **IPv6 Address** and **Link-local Address**.

### 4. 17. 2. IPv6 WAN

1. Visit <http://tplinkwifi.net>, and log in with the username and password you set for the router.
2. Go to **IPv6 > IPv6 WAN**.

3. Select the **WAN Connection Type** according to your ISP network topology:
- **Dynamic IPv6** - Connections which use dynamic IPv6 address assignment.
  - **Static IPv6** - Connections which use static IPv6 address assignment.
  - **PPPoEv6** - Connections which use PPPoEV6 that requires a username and password.
  - **Tunnel 6to4** - Connections which use 6to4 address assignment.

### Dynamic IPv6

- **IPv6 Address** - The IPv6 address assigned by your ISP dynamically.
- **Prefix Length** - The length of IPv6 address prefix.

- **IPv6 Gateway** - Enter the default gateway provided by your ISP.
- **Addressing Type** - There are two types of assignation for IPv6 address: SLAAC (Stateless address auto-configuration) and DHCPv6 (Dynamic Host Configuration Protocol for IPv6) Server.
- **MTU(Bytes)** - The normal MTU (Maximum Transmission Unit) value for most Ethernet networks is 1500 Bytes. For some ISPs, you may need to modify the MTU. But this is rarely required, and should not be done unless you are sure it is necessary for your ISP connection.

If your ISP gives you one or two DNS IPv6 addresses, select Set IPv6 DNS Server manually and enter the IPv6 DNS Server and Secondary IPv6 DNS Server into the correct fields. Otherwise, the DNS servers will be assigned from ISP dynamically.

- **Enable MLD Proxy** - Enable the Multicast Listener Discovery (MLD) Proxy function if you need.
- **Set IPv6 DNS Server manually** - Enter the DNS IPv6 address provided by your ISP.
- **Secondary IPv6 DNS Server** - Enter another DNS IPv6 address provided by your ISP.

 Tips:

If you get Address not found error when you access a website, it is likely that your DNS servers are set up improperly. You should contact your ISP to get DNS server addresses.

## Static IPv6



- **IPv6 Address** - Enter the IPv6 address provided by your ISP.
- **Prefix Length** - The length of IPv6 address prefix.
- **IPv6 Gateway** - Enter the default gateway provided by your ISP.
- **IPv6 DNS Server** - Enter the DNS IPv6 address provided by your ISP.
- **Secondary IPv6 DNS Server** - Enter another DNS IPv6 address provided by your ISP.

- **MTU(Bytes)** - The normal MTU (Maximum Transmission Unit) value for most Ethernet networks is 1500 Bytes. For some ISPs, you may need to modify the MTU. But this is rarely required, and should not be done unless you are sure it is necessary for your ISP connection.
- **Enable MLD Proxy** - Enable the Multicast Listener Discovery (MLD) Proxy function if you need.

## PPPoEv6

- **PPP Username/Password** - Enter the User Name and Password provided by your ISP. These fields are case-sensitive.
- **Authentication Type** – Choose one authentication type from AUTO-AUTH, PAP, CHAP and MS-CHAP.
- **Addressing Type** - There are two types of assignment for IPv6 address: SLAAC (Stateless address auto-configuration) and DHCPv6 (Dynamic Host Configuration Protocol for IPv6) Server.
- **MTU(Bytes)** - The normal MTU (Maximum Transmission Unit) value for most Ethernet networks is 1480 Bytes. It is not recommended that you change the default MTU size unless required by your ISP.
- **Enable MLD Proxy** - Enable the Multicast Listener Discovery (MLD) Proxy function if you need.
- **Use IPv6 address specified by ISP** - Input a static IPv6 address from the ISP.
- **Set IPv6 DNS Server manually** - Enter the IP address of the IPv6 DNS server and secondary IPv6 DNS server.

## Tunnel 6to4

- [WAN Connection](#) - Display the available WAN connection.

4. Click [Save](#).

### 4. 17. 3. IPv6 LAN

1. Visit <http://tplinkwifi.net>, and log in with the username and password you set for the router.
2. Go to [IPv6 > IPv6 LAN](#).

3. Select the [Address Autoconfiguration Type](#) which determines the way how the router assigns IPv6 address for PCs on the LAN:
  - [Address Autoconfiguration Type](#) - RADAD (Router Advertisement Daemon) and DHCPv6 (Dynamic Host Configuration Protocol for IPv6) Server.
  - [Site Prefix Configuration Type](#) - The type of IPv6 address prefix.
    - [Delegated](#) - Get the IPv6 address prefix from the ISP automatically, and the device will delegate it to the LAN.
    - [Static](#) - Configure the [Site Prefix](#) and [Site Prefix Length](#) manually. Please contact your ISP to get more information before you configure them.

58

☞ **Tips:** If your IPv6 wan connection type is "Tunnel 6to4", the Site Prefix Configuration Type should be "Static" to make sure "Tunnel 6to4" works properly.

4. Click [Save](#).

## 4. 18. System Tools

### 4. 18. 1. Time Settings

This page allows you to set the time manually or to configure automatic time synchronization. The Router can automatically update the time from an NTP server via the internet.

1. Visit <http://tplinkwifi.net>, and log in with the username and password you set for the router.
2. Go to [System Tools](#) > [Time Settings](#).

➤ **To set time manually:**

1. Select your local [time zone](#).
2. Enter the [Date](#) in Month/Day/Year format.
3. Enter the [Time](#) in Hour/Minute/Second format.
4. Click [Save](#).

➤ **To set time automatically:**

5. Select your local [time zone](#).
6. Enter the address or domain of the [NTP Server 1](#) or [NTP Server 2](#).
7. Click [Get GMT](#) to get time from the internet if you have connected to the internet.



➤ **To set Daylight Saving:**

1. Select [Enable DaylightSaving](#).
2. Select the start time from the drop-down list in the [Start](#) field.
3. Select the end time from the drop-down list in the [End](#) field.
4. Click [Save](#).

**Note:**

This setting will be used for some time-based functions such as firewall. You must specify your time zone once you log in to the router successfully; otherwise, time-based functions will not take effect.

## 4. 18. 2. LED Control

The LED Control allows you to turn on or off the LEDs on your device according to a specific time schedule.

1. Visit <http://tplinkwifi.net>, and log in with the username and password you set for the router.
2. Go to [System Tools > LED Control](#).

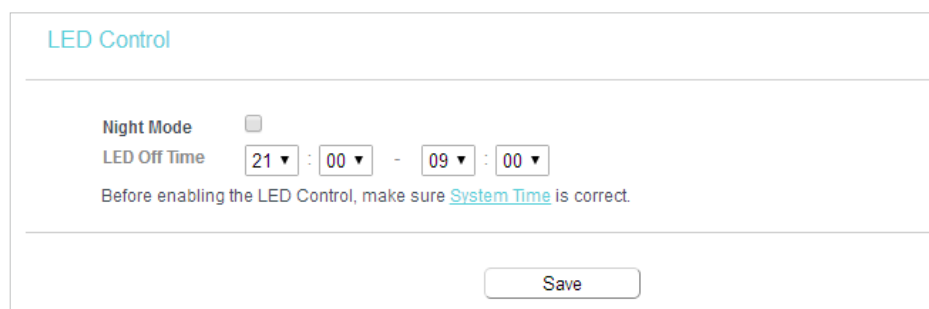

LED Control

Night Mode

LED Off Time 21 : 00 - 09 : 00

Before enabling the LED Control, make sure [System Time](#) is correct.

Save

3. Enable the [Night Mode](#).
4. Set the [LED Off Time](#) and click [Save](#).

## 4. 18. 3. Diagnostic

Diagnostic is used to test the connectivity between the router and the host or other network devices.

1. Visit <http://tplinkwifi.net>, and log in with the username and password you set for the router.
2. Go to [System Tools > Diagnostic](#).

- **Diagnostic Tool** - Select one diagnostic tool.
  - **Ping** - This diagnostic tool troubleshoots connectivity, reachability, and name resolution to a given host or gateway.
  - **Tracerouter** - This diagnostic tool tests the performance of a connection.

**Note:**

You can use ping/traceroute to test both numeric IP address or domain name. If pinging/tracerouting the IP address is successful, but pinging/tracerouting the domain name is not, you might have a name resolution problem. In this case, ensure that the domain name you are specifying can be resolved by using Domain Name System (DNS) queries.

- **IP Address/Domain Name** - Enter the destination IP address (such as 192.168.0.1) or Domain name (such as www.tp-link.com).
  - **Pings Count** - The number of Ping packets for a Ping connection.
  - **Ping Packet Size** - The size of Ping packet.
  - **Ping Timeout** - Set the waiting time for the reply of each Ping packet. If there is no reply in the specified time, the connection is overtime.
  - **Traceroute Max TTL** - The max number of hops for a Traceroute connection.
3. Click **Start** to check the connectivity of the internet.
  4. The **Diagnostic Results** page displays the diagnosis result. If the result is similar to the following figure, the connectivity of the internet is fine.

```

Diagnostic Results
-----
Pinging 192.168.0.1 with 64 bytes of data:

Reply from 192.168.0.1: bytes=64 time=1 TTL=64 seq=1
Reply from 192.168.0.1: bytes=64 time=1 TTL=64 seq=2
Reply from 192.168.0.1: bytes=64 time=1 TTL=64 seq=3
Reply from 192.168.0.1: bytes=64 time=1 TTL=64 seq=4

Ping statistics for 192.168.0.1
Packets: Sent = 4, Received = 4, Lost = 0 (0% loss)
Approximate round trip times in milliseconds:
  Minimum = 1, Maximum = 1, Average = 1

```

**Note:** Only one user can use this tool at one time. Options “Number of Pings”, “Ping Size” and “Ping Timeout” are used for the Ping function. Option “Tracert Hops” is used for the Tracert function.

#### 4. 18. 4. Firmware Upgrade

TP-Link is dedicated to improving and enriching the product features, giving users a better network experience. We will release the latest firmware at TP-Link official website. You can download the latest firmware file from the [Support](#) page of our website [www.tp-link.com](http://www.tp-link.com) and upgrade the firmware to the latest version.

1. Download the latest firmware file for the router from our website [www.tp-link.com](http://www.tp-link.com).
2. Visit <http://tplinkwifi.net>, and log in with the username and password you set for the router.
3. Go to [System Tools > Firmware Upgrade](#).
4. Click [Choose File](#) to locate the downloaded firmware file, and click [Upgrade](#).

**Firmware Upgrade**

---

Firmware File Path:  No file chosen

Firmware version:

Hardware version:

---

#### 4. 18. 5. Factory Defaults

1. Visit <http://tplinkwifi.net>, and log in with the username and password you set for the router.
2. Go to [System Tools > Factory Defaults](#). Click [Restore](#) to reset all settings to the default values.



- The default **Username**: admin
- The default **Password**: admin
- The default **IP Address**: 192.168.0.1
- The default **Subnet Mask**: 255.255.255.0

#### 4. 18. 6. Backup & Restore

The configuration settings are stored as a configuration file in the router. You can backup the configuration file in your computer for future use and restore the router to the previous settings from the backup file when needed.

1. Visit <http://tplinkwifi.net>, and log in with the username and password you set for the router.
2. Go to **System Tools > Backup & Restore**.

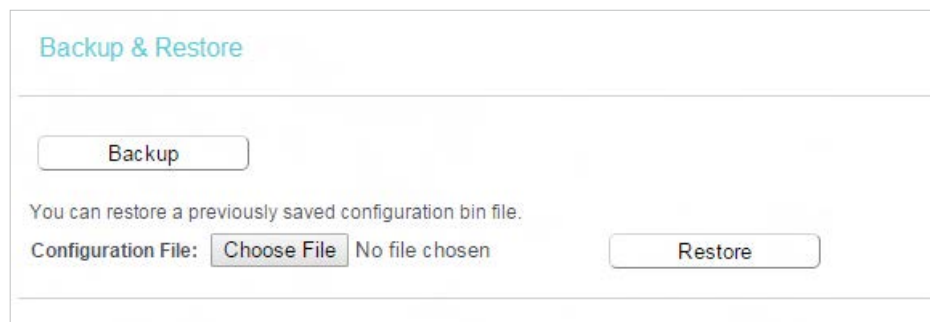

##### ➤ To backup configuration settings:

Click **Backup** to save a copy of the current settings in your local computer. A ".bin" file of the current settings will be stored in your computer.

##### ➤ To restore configuration settings:

1. Click **Choose File** to locate the backup configuration file stored in your computer, and click **Restore**.
2. Wait a few minutes for the restoring and rebooting.

##### 📌 Note:

During the restoring process, do not power off or reset the router.

#### 4. 18. 7. Reboot

1. Visit <http://tplinkwifi.net>, and log in with the username and password you set for the router.
2. Go to **System Tools > Reboot**, and you can restart your router.

System Reboot

Click Reboot to restart the device without applying any changes to your current settings.

Reboot

Enable Auto Reboot: Disable ▾

Save

3. Enable the auto reboot function as needed.

- **Disable** - Disable the auto reboot function.
- **Timeout** - Specify a time period(1-72 hours), then the router will reboot automatically after every this interval.
- **Schedule** - The router will reboot automatically according to a specific time schedule.

Some settings of the router will take effect only after rebooting, including:

- Change the LAN IP Address (system will reboot automatically).
- Change the DHCP Settings.
- Change the Working Modes.
- Change the Web Management Port.
- Upgrade the firmware of the router (system will reboot automatically).
- Restore the router to its factory defaults (system will reboot automatically).
- Update the configuration with the file (system will reboot automatically).

#### 4. 18. 8. Administrator

1. Visit <http://tplinkwifi.net>, and log in with the username and password you set for the router.
2. Go to **System Tools > Administrator**, and you can change the factory default username and password of the router, and manage your router from a remote location via the internet.

➤ **To view and change the account settings:**

**Manage Control**

**Current User Status**

User Type: Admin  
 Username: admin  
 Host IP Address: 192.168.0.100  
 Host MAC Address: FC:AA:14:0D:23:18

**Account Management**

The username and password must not exceed 15 characters in length!

Old Password:

New User Name:

New Password:

Confirm password:

It is strongly recommended that you change the default username and password of the router, for all users that try to access the router's web management or Quick Setup will be prompted for the router's username and password.

**Note:**

The new username and password must not exceed 15 characters and not include any spacing.

➤ **To manage your router via the internet:**

1. Specify the management web port number and click [Save](#).

**Service Configuration**

	HTTP Service	HTTPS Service	Available Host (IP/MAC)
Local Management	Port: 80	Enable <input type="checkbox"/> Port: 443	<input type="text"/>
Remote Management	Enable <input type="checkbox"/> Port: 80	Enable <input type="checkbox"/> Port: 443	<input type="text"/>

**Certificate Download**

Local Management via HTTPS and Remote Management via HTTPS are disabled.

- **Port** - The default management web port number is 80 for HTTP, 443 for HTTPS. For greater security, you can change the management web port to a number between 1024 and 65535 but do not use the number of any common service port. Tick **Enable** to enable local or remote management via HTTP or HTTPS.
  - **Available Host (IP/MAC)** - This is the current address you will use when accessing your router from the internet.
  - **Certificate** - A file that provides you with authentication information. Download and install the certificate for Local/Remote Management via HTTPS if you need it. Once the certificate is installed, warnings will not pop up when you access the router via HTTPS.
2. Enter your router's WAN IP address into your browser's address bar, followed by a colon and the custom port number you set in the Web Management Port box. For example, if your Router's WAN address is 202.96.12.8 and you use port number 8080, enter `http://202.96.12.8:8080` in your browser.

### 3. Enter the router's password to access the web management page.

#### Note:

- Be sure to change the router's default password to a secure password.
- If the web management port conflicts with the one used for a Virtual Server entry, the entry will be automatically disabled after the setting is saved.

## 4. 18. 9. System Log

1. Visit <http://tplinkwifi.net>, and log in with the username and password you set for the router.
2. Go to **System Tools > System Log**, and you can view the logs of the router.

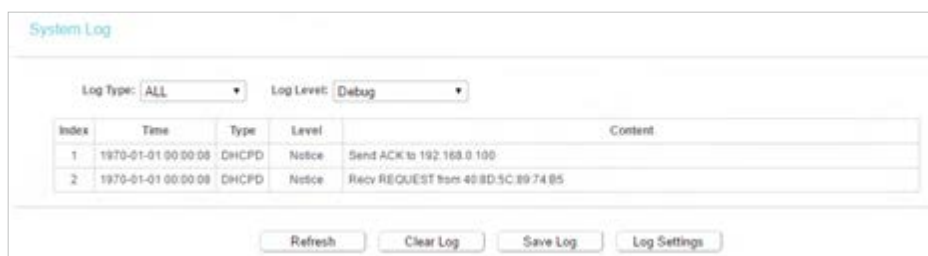

- **Loge Type** -By selecting the log type, only logs of this type will be shown.
- **Log Level** - By selecting the log level, only logs of this level will be shown.
- **Refresh** - Refresh the page to show the latest log list.
- **Clear Log** - All the logs will be deleted from the router permanently, not just from the page.

## 4. 18. 10. Traffic Statistics

1. Visit <http://tplinkwifi.net>, and log in with the username and password you set for the router.
2. Go to **System Tools > Statistics**, and you can monitor the network traffic of each device on the LAN, including total traffic and the value of the last Packets Statistic interval in seconds.



3. Enable [Traffic Statistics](#). If it is disabled, the function of DoS protection in Security settings will be disabled.

- [Statistics Interval](#) - The default value is 10. Select a value between 5 and 60 seconds in the pull-down list. The Packets Statistic interval value indicates the time section of the packets statistic.
- [IP Address/MAC Address](#) - The IP Address and MAC address are displayed with related statistics.
- [Total](#)
  - [Packets](#) - The total number of packets received and transmitted by the Router.
  - [Bytes](#) - The total number of bytes received and transmitted by the Router.
- [Current](#)
  - [Packets](#) - The number of packets received and transmitted per second at the specified Packets Statistics interval.
  - [Bytes](#) - The number of bytes received and transmitted per second at the specified Packets Statistics interval.
  - [ICMP Tx](#) - The number of ICMP packets transmitted to the WAN per second at the specified Packets Statistics interval. It is shown like "current transmitting rate / Max transmitting rate".
  - [UDP Tx](#) - The number of UDP packets transmitted to the WAN per second at the specified Packets Statistics interval. It is shown like "current transmitting rate / Max transmitting rate".
  - [TCP SYN Tx](#) - The number of TCP SYN packets transmitted to the WAN per second at the specified Packets Statistics interval. It is shown like "current transmitting rate / Max transmitting rate".
- [Operation](#)
  - [Reset](#) - Renew the values of the entry to zero.
  - [Delete](#) - Delete the existing entry in the table.

Click the [Refresh](#) button to refresh the page.

Click the [Reset All](#) button to reset the values of all entries to zero.

Click the [Delete All](#) button to delete all entries in the table.

## 4. 19. Log Out

Click [Logout](#) at the bottom of the main menu, and you will log out of the web page and be directed to the login window.



## Chapter 5

---

# Configure the Router in Access Point Mode

---

This chapter presents how to configure the various features of the router in Access Point Mode.

It contains the following sections:

- [Status](#)
- [Quick Setup](#)
- [Operation Mode](#)
- [Network](#)
- [Dual Band Selection](#)
- [Wireless\(2.4GHz or 5GHz\)](#)
- [Guest Network](#)
- [DHCP](#)
- [System Tools](#)
- [Log Out](#)

## 5.1. Status

1. Visit <http://tplinkwifi.net>, and log in with the username and password you set for the router.
2. Go to **Status**. You can view the current status information of the router.

Status	
Firmware Version:	TP-LINK V1.0.0.0 (Build 150814)
Hardware Version:	Archer C20 (V1.0)
LAN	
MAC Address:	00:0A:EB:20:05:A0
IP Address:	192.168.0.1
Subnet Mask:	255.255.255.0
Wireless 2.4GHz	
Operation Mode:	Access Point
Wireless Radio:	Enabled
Name(SSID):	TP-Link_05A0
Mode:	11bgn mixed
Channel:	Auto(Channel 1)
Channel Width:	Auto
MAC Address:	00:0A:EB:20:05:A0
Wireless 5GHz	
Operation Mode:	Access Point
Wireless Radio:	Enabled
Name(SSID):	TP-Link_05A0_5G
Mode:	11a/n/ac mixed
Channel:	Auto(Channel 36)
Channel Width:	Auto
MAC Address:	00:0A:EB:20:05:9F
Ethernet	
Internet:	Unplugged
LAN1:	Unplugged
LAN2:	Unplugged
LAN3:	100Mbps full duplex
LAN4:	Unplugged
System Up Time: 0 day(s) 00:07:02 <input type="button" value="Refresh"/>	

- **Firmware Version** - The version information of the router's firmware.
- **Hardware Version** - The version information of the router's hardware.
- **LAN** - This field displays the current settings of the LAN, and you can configure them on the **Network > LAN** page.
  - **MAC address** - The physical address of the router.
  - **IP address** - The LAN IP address of the router.
  - **Subnet Mask** - The subnet mask associated with the LAN IP address.
- **Wireless 2.4GHz/5GHz** - This field displays the basic information or status of the wireless function, and you can configure them on the **Wireless > Basic Settings** page.
  - **Operation Mode** - The current wireless working mode in use.

- **Wireless Radio** - Indicates whether the wireless radio feature of the Router is enabled or disabled.
  - **Name(SSID)** - The SSID of the Router.
  - **Mode** - The current wireless mode which the router works on.
  - **Channel** - The current wireless channel in use.
  - **Channel Width** - The current wireless channel width in use.
  - **MAC Address** - The physical address of the router.
- **Ethernet** - Displays the current status of the Ethernet ports.
  - **System Up Time** - The length of time since the AP was last powered on or reset. Click **Refresh** to get the latest status and settings of the AP.

## 5.2. Quick Setup

1. Visit <http://tplinkwifi.net>, and log in with the username and password you set for the router.
2. Go to **Quick Setup**.



3. Click **Next** to start. Then follow the step-by-step instructions to connect your router to the internet.

## 5.3. Operation Mode

The router supports three operation modes: Wireless Router mode, Access Point mode and Range Extender. In Access Point mode, the device can be connected to a wired network and transform the wired access into wireless one. If you already have a wired router, you can use this mode. To switch to Access Point mode:

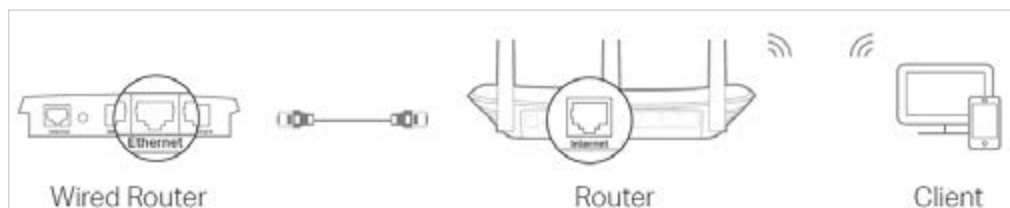

1. Find the router's Internet port, and connect it to the Ethernet port (LAN port) of your existing wired router. Then connect the power adapter and turn on the router.
2. Connect your computer to the router via an Ethernet cable or wirelessly by using the SSID (network name) and Wireless Password printed on the label at the bottom of the router.
3. Visit <http://tplinkwifi.net>, and log in with the username and password you set for the router.
4. Go to [Operation Mode](#).
5. Select the [Access Point](#) mode and click [Save](#).

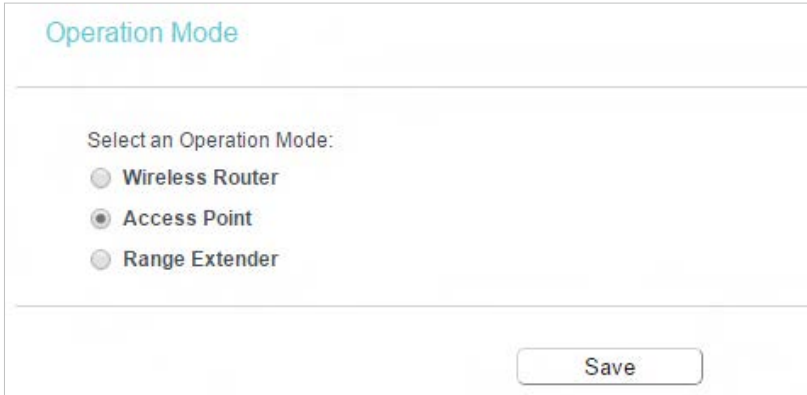

Operation Mode

Select an Operation Mode:

Wireless Router

Access Point

Range Extender

Save

## 5.4. Network

### 5.4.1. LAN

1. Visit <http://tplinkwifi.net>, and log in with the username and password you set for the router.
2. Go to [Network > LAN](#).
3. Configure the IP parameters of the LAN and click [Save](#).



LAN Settings

LAN Type:

Note: The IP parameters cannot be configured if you have chosen Smart IP(DHCP)

(In this situation the device will help you configure the IP parameters automatically as you need).

MAC Address: 00:0A:EB:20:05:A0

IP Address:

Subnet Mask:

Gateway:  (optional)

Save

- **LAN Type** - Select Smart IP(DHCP) to get IP address from DHCP server, or select static IP to configure IP address manually.
- **MAC Address** - The physical address of the LAN ports. The value can not be changed.
- **IP Address** - Enter the IP address in dotted-decimal notation of your router.
- **Subnet Mask** - An address code that determines the size of the network. Normally 255.255.255.0 is used as the subnet mask.
- **Gateway (Optional)** - It is suggested to input the IP address of the LAN port of the router. The default value is 192.168.0.1.

**Note:**

- If you change the IP address, you must use the new IP address to login to the device.
- If you select the type of smart IP(DHCP), the DHCP server in this device will not startup.
- If the new IP address you set is not in the same subnet with the previous one, the IP Address pool in the DHCP server will be configured automatically.

## 5. 5. Dual Band Selection

1. Visit <http://tplinkwifi.net>, and log in with the username and password you set for the router.
2. Go to **Dual Band Selection**.
3. Select the working radio band as needed and click **Save**.

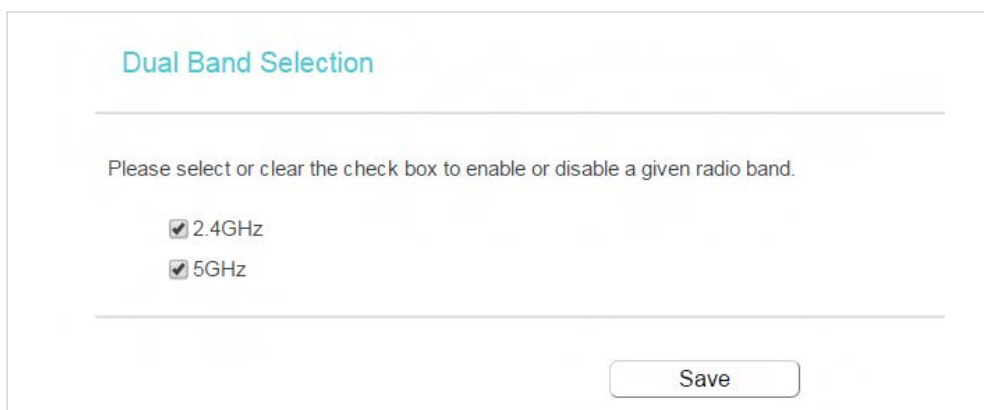

**Dual Band Selection**

---

Please select or clear the check box to enable or disable a given radio band.

2.4GHz

5GHz

---

Save

## 5. 6. Wireless(2.4GHz or 5GHz)

### 5. 6. 1. Wireless Settings

1. Visit <http://tplinkwifi.net>, and log in with the username and password you set for the router.
2. Go to **Wireless > Basic Settings**.

3. Configure the basic settings for the wireless network and click [Save](#).

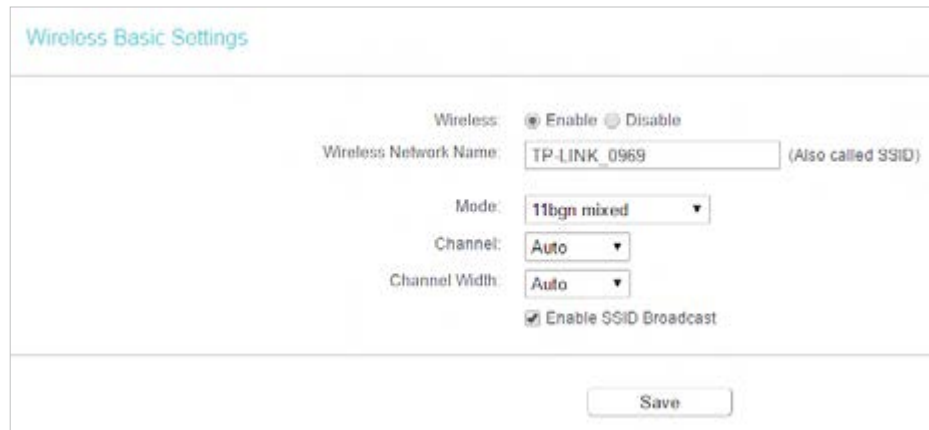

- [Wireless](#) - Enable or disable wireless network.
- [Wireless Network Name](#) - Enter a value of up to 32 characters. The same Name (SSID) must be assigned to all wireless devices in your network.
- [Mode](#) - You can choose the appropriate “Mixed” mode.
- [Channel](#) - This field determines which operating frequency will be used. The default channel is set to [Auto](#). It is not necessary to change the wireless channel unless you notice interference problems with another nearby access point.
- [Channel Width](#) - This field determines which operating frequency will be used. It is not necessary to change the wireless channel unless you notice interference problems with another nearby access point. If you select auto, then AP will choose the best channel automatically.
- [Enable SSID Broadcast](#) - If enabled, the router will broadcast the wireless network name (SSID).

### 5.6.2. WPS

WPS (Wi-Fi Protected Setup) can help you to quickly and securely connect to a network. This section will guide you to add a new wireless device to your router’s network quickly via WPS.

**Note:**

The WPS function cannot be configured if the wireless function of the router is disabled. Please make sure the wireless function is enabled before configuration.

1. Visit <http://tplinkwifi.net>, and log in with the username and password you set for the router.
2. Go to [Wireless > WPS](#).
3. Follow one of the following three methods to connect your client device to the router’s Wi-Fi network.

## Method ONE: Press the WPS Button on Your Client Device

1. Keep the WPS Status as **Enabled** and click **Add Device**.

WPS (Wi-Fi Protected Setup)

WPS: Enabled

Current PIN: 12345670

Disable device PIN

Add a new device:

2. Select **Press the WPS button of the new device within the next two minutes** and click **Connect**.

WPS Settings

Enter new device PIN.

PIN:

Press the WPS button of the new device within the next two minutes.

3. Within two minutes, press the WPS button on your client device.
4. A success message will appear on the WPS page if the client device has been successfully added to the router's network.

## Method TWO: Enter the Client's PIN

1. Keep the WPS Status as **Enabled** and click **Add Device**.

WPS (Wi-Fi Protected Setup)

WPS: Enabled

Current PIN: 12345670

Disable device PIN

Add a new device:

2. Select **Enter new device PIN**, enter your client device's current PIN in the **PIN** field and click **Connect**.

WPS Settings

Enter new device PIN.

PIN:

Press the WPS button of the new device within the next two minutes.

3. A success message will appear on the WPS page if the client device has been successfully added to the router's network.

### Method THREE: Enter the Router's PIN

1. Keep the WPS Status as **Enabled** and get the **Current PIN** of the router.

WPS (Wi-Fi Protected Setup)

WPS: Enabled

Current PIN: 12345670

Disable device PIN

Add a new device:

2. Enter the router's current PIN on your client device to join the router's Wi-Fi network.

### 5. 6. 3. Wireless Security

1. Visit <http://tplinkwifi.net>, and log in with the username and password you set for the router.
2. Go to **Wireless > Wireless Security**.
3. Configure the security settings of your wireless network and click **Save**.

Wireless Security Settings

Note: WEP security, WPA/WPA2 - Enterprise authentication and TKIP encryption are not supported with WPS enabled. For network security, it is strongly recommended to enable wireless security and select WPA2-PSK AES encryption.

Disable Wireless Security

WPA/WPA2 - Personal (Recommended)

Authentication Type: WPA2-PSK

Encryption: AES

Wireless Password: 12345670

Group Key Update Period: 0

WPA/WPA2 - Enterprise

Authentication Type: Auto

Encryption: Auto

RADIUS Server IP:

RADIUS Server Port: 1812 (1-65535, 0 stands for default port 1812)

RADIUS Server Password:

Group Key Update Period: 0

WEP

Authentication Type: Open System

WEP Key Format: Hexadecimal

Selected Key: WEP Key Key Type

Key 1:  Disabled

Key 2:  Disabled

Key 3:  Disabled

Key 4:  Disabled



- **Disable Wireless Security** - The wireless security function can be enabled or disabled. If disabled, wireless clients can connect to the router without a password. It's strongly recommended to choose one of the following modes to enable security.
- **WPA-PSK/WPA2-Personal** - It's the WPA/WPA2 authentication type based on pre-shared passphrase.
  - **Authentication Type** - Select **Auto**, **WPA-PSK** or **WPA2-PSK**.
  - **Encryption** - Select **Auto**, **TKIP** or **AES**.
  - **Wireless Password** - Enter ASCII or Hexadecimal characters. For Hexadecimal, the length should be between 8 and 64 characters; for ASCII, the length should be between 8 and 63 characters.
  - **Group Key Update Period** - Specify the group key update interval in seconds. The value can be 0 or at least 30. Enter 0 to disable the update.
- **WPA /WPA2-Enterprise** - It's based on Radius Server.
  - **Authentication Type** - Select **Auto**, **WPA** or **WPA2**.
  - **Encryption** - Select **Auto**, **TKIP** or **AES**.
  - **Radius Server IP** - Enter the IP address of the Radius server.
  - **Radius Server Port** - Enter the port that Radius server used.
  - **Radius Server Password** - Enter the password for the Radius server.
  - **Group Key Update Period** - Specify the group key update interval in seconds. The value should be 30 or above. Enter 0 to disable the update.
- **WEP** - It is based on the IEEE 802.11 standard.
  - **Authentication Type** - The default setting is **Auto**, which can select Shared Key or Open System authentication type automatically based on the wireless client's capability and request.
  - **WEP Key Format** - Hexadecimal and ASCII formats are provided here. Hexadecimal format stands for any combination of hexadecimal digits (0-9, a-f, A-F) in the specified length. ASCII format stands for any combination of keyboard characters in the specified length.
  - **WEP Key (Password)** - Select which of the four keys will be used and enter the matching WEP key. Make sure these values are identical on all wireless clients in your network.
  - **Key Type** - Select the WEP key length (64-bit, 128-bit or 152-bit) for encryption. **Disabled** means this WEP key entry is invalid.
  - **64-bit** - Enter 10 hexadecimal digits (any combination of 0-9, a-f and A-F. Null key is not permitted) or 5 ASCII characters.
  - **128-bit** - Enter 26 hexadecimal digits (any combination of 0-9, a-f and A-F. Null key is not permitted) or 13 ASCII characters.

### 5. 6. 4. Wireless MAC Filtering

Wireless MAC Filtering is used to deny or allow specific wireless client devices to access your network by their MAC addresses.

#### I want to:

Deny or allow specific wireless client devices to access my network by their MAC addresses.

For example, you want the wireless client A with the MAC address 00-0A-EB-B0-00-0B and the wireless client B with the MAC address 00-0A-EB-00-07-5F to access the router, but other wireless clients cannot access the router.

#### How can I do that?

1. Visit <http://tplinkwifi.net>, and log in with the username and password you set for the router.
2. Go to [Wireless > Wireless MAC Filtering](#).
3. Click [Enable](#) to enable the Wireless MAC Filtering function.
4. Select [Allow the stations specified by any enabled entries in the list to access](#) as the filtering rule.
5. Delete all or disable all entries if there are any entries already.
6. Click [Add New](#) and fill in the blank.

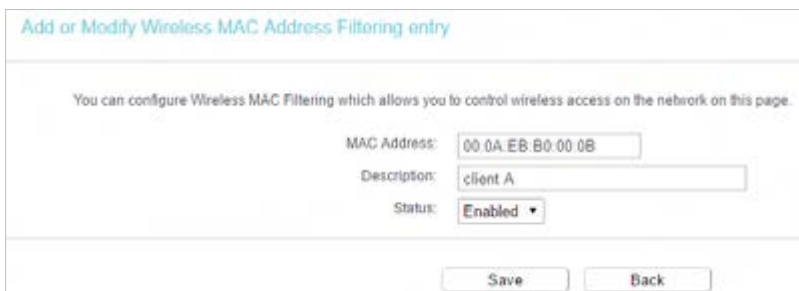

Add or Modify Wireless MAC Address Filtering entry

You can configure Wireless MAC Filtering which allows you to control wireless access on the network on this page.

MAC Address:

Description:

Status:

- 1) Enter the MAC address 00-0A-EB-B0-00-0B/00-0A-EB-00-07-5F in the MAC Address field.
  - 2) Enter wireless client A/B in the Description field.
  - 3) Select [Enabled](#) in the Status drop-down list.
  - 4) Click [Save](#) and click [Back](#).
7. The configured filtering rules should be listed as the picture shows below.

Wireless MAC Filtering

You can configure Wireless MAC Filtering which allows you to control wireless access on the network on this page.

Wireless MAC Filtering:  Enabled  Disable

Filtering Rules

Deny the stations specified by any enabled entries in the list to access.

Allow the stations specified by any enabled entries in the list to access.

<input type="checkbox"/>	MAC Address	Status	Host	Description	Edit
<input checked="" type="checkbox"/>	00:0A:EB:00:00:0B	Enabled	TP-LINK_TAFF	client A	<a href="#">Edit</a>
<input checked="" type="checkbox"/>	00:0A:EB:00:07:5F	Enabled	TP-LINK_TAFF	Client B	<a href="#">Edit</a>

**Done!**

Now only client A and client B can access your network.

### 5.6.5. Wireless Advanced

1. Visit <http://tplinkwifi.net>, and log in with the username and password you set for the router.
2. Go to **Wireless > Wireless Advanced**.
3. Configure the advanced settings of your wireless network and click **Save**.

**Note:**

If you are not familiar with the setting items on this page, it's strongly recommended to keep the provided default values; otherwise it may result in lower wireless network performance.

Wireless Advanced

Notice: For better performance, Fragmentation Threshold is disabled when wireless mode include 11n or 11ac.

Transmit Power:

Beacon Interval:  (25-1000)

RTS Threshold:  (1-2346)

Fragmentation Threshold:  (256-2346)

DTIM Interval:  (1-255)

Enable Short GI

Enable Client Isolation

Enable WMM

- **Transmit Power** - Select **High**, **Middle** or **Low** which you would like to specify for the router. **High** is the default setting and recommended.
- **Beacon Interval** - Enter a value between 40-1000 milliseconds for Beacon Interval here. Beacon Interval value determines the time interval of the beacons. The beacons

are the packets sent by the router to synchronize a wireless network. The default value is 100.

- **RTS Threshold** - Here you can specify the RTS (Request to Send) Threshold. If the packet is larger than the specified RTS Threshold size, the router will send RTS frames to a particular receiving station and negotiate the sending of a data frame. The default value is 2346.
- **Fragmentation Threshold** - This value is the maximum size determining whether packets will be fragmented. Setting a low value for the Fragmentation Threshold may result in poor network performance because of excessive packets. 2346 is the default setting and is recommended.
- **DTIM Interval** - This value determines the interval of the Delivery Traffic Indication Message (DTIM). A DTIM field is a countdown field informing clients of the next window for listening to broadcast and multicast messages. When the router has buffered broadcast or multicast messages for associated clients, it sends the next DTIM with a DTIM Interval value. You can specify the value between 1-255 Beacon Intervals. The default value is 1, which indicates the DTIM Interval is the same as Beacon Interval.
- **Enable Short GI** - It is recommended to enable this function, for it will increase the data capacity by reducing the guard interval time.
- **Enable Client Isolation** - This function isolates all connected wireless stations so that wireless stations cannot access each other through WLAN.
- **Enable WMM** - WMM function can guarantee the packets with high-priority messages being transmitted preferentially. It is strongly recommended to enable this function.

### 5. 6. 6. Wireless Statistics

1. Visit <http://tplinkwifi.net>, and log in with the username and password you set for the router.
2. Go to **Wireless > Wireless Statistics** to check the data packets sent and received by each client device connected to the router.

The screenshot shows the 'Wireless Stations Status' page. At the top, it says 'Wireless Stations Currently Connected: 1' with a 'Refresh' button. Below this is a table with the following data:

ID	MAC Address	Current Status	Received Packets	Sent Packets	SSID
1	44:00:10:BF:3B:A7	Associated	29	19	TP-LINK_XXXXXX

- **MAC Address** - The MAC address of the connected wireless client.
- **Current Status** - The running status of the connected wireless client.
- **Received Packets** - Packets received by the wireless client.
- **Sent Packets** - Packets sent by the wireless client.

- **SSID** - SSID that the station associates with.

### 5. 6. 7. Throughput Monitor

1. Visit <http://tplinkwifi.net>, and log in with the username and password you set for the router.
2. Go to **Wireless > Throughput Monitor** to watch wireless throughput info



- **Rate** - The Throughput unit.
- **Run Time** - How long this function is running.
- **Transmit** - Wireless transmit rate information.
- **Receive** - Wireless receive rate information.

Click **Start** to start wireless throughput monitor.

Click **Stop** to stop wireless throughput monitor.

## 5. 7. Guest Network

Guest Network allows you to provide Wi-Fi access for guests without disclosing your host network. When you have guests in your house, apartment, or workplace, you can create a guest network for them. In addition, you can customize guest network settings to ensure network security and privacy.

1. Visit <http://tplinkwifi.net>, and log in with the username and password you set for the router.
2. Go to **Guest Network**.
3. Enable the **Guest Network** function.

4. Create a network name for your guest network.
5. Select the **Security** type and create the **Password** of the guest network.
6. Select **Schedule** from the **Access Time** drop-down list and customize it for the guest network.
7. Click **Save**.

Guest Network

Guest Network Isolation:

Band Select:

Guest Network:  Enable  Disable

Network Name:

Max Guests number:

Security:

Access Time:

*Click the schedule table or use the 'Add' button to choose the period on which you need the guest network off automatically!*  
 The Schedule is based on the time of the Router. The time can be set in "System Tools -> Time Settings".

Wireless Schedule:  Enable  Disable

Apply To:

Start Time:

End Time:

Time	0:00	1:00	2:00	3:00	4:00	5:00	6:00	7:00	8:00	9:00	10:00	11:00	12:00	13:00	14:00
Sun.															
Mon.															
Tues.															
Wed.															
Thur.															
Fri.															
Sat.															

- **Guest Network Isolation** - If enabled, guests are isolated from each other.

## 5.8. DHCP

By default, the DHCP (Dynamic Host Configuration Protocol) Server is enabled and the router acts as a DHCP server; it dynamically assigns TCP/IP parameters to client devices from the IP Address Pool. You can change the settings of DHCP Server if necessary, and you can reserve LAN IP addresses for specified client devices.

### 5.8.1. DHCP Settings

1. Visit <http://tplinkwifi.net>, and log in with the username and password you set for the router.
2. Go to **DHCP > DHCP Settings**.

### 3. Specify DHCP server settings and click [Save](#).

- **DHCP Server** - Enable or disable the DHCP server. If disabled, you must have another DHCP server within your network or else you must configure the computer manually.
- **Start IP Address** - Specify an IP address for the DHCP Server to start with when assigning IP addresses. 192.168.0.100 is the default start address.
- **End IP Address** - Specify an IP address for the DHCP Server to end with when assigning IP addresses. 192.168.0.199 is the default end address.
- **Address Lease Time** - The Address Lease Time is the amount of time a network user will be allowed to connect to the router with the current dynamic IP Address. When time is up, the user will be automatically assigned a new dynamic IP address. The range of the time is 1 ~ 2880 minutes. The default value is 1.
- **Default Gateway (Optional)** - It is suggested to input the IP address of the LAN port of the router. The default value is 192.168.0.1.
- **Default Domain (Optional)** - Input the domain name of your network.
- **DNS Server (Optional)** - Input the DNS IP address provided by your ISP.
- **Secondary DNS Server (Optional)** - Input the IP address of another DNS server if your ISP provides two DNS servers.

**Note:**

- To use the DHCP server function of the router, you must configure all computers on the LAN as [Obtain an IP Address automatically](#).
- When you choose [Smart IP \(DHCP\)](#) in [Network > LAN](#), the DHCP Server function will be disabled. You will see the page as below.

LAN Settings

LAN Type: **Smart IP(DHCP)**

Note: The IP parameters cannot be configured if you have chosen Smart IP(DHCP)  
(In this situation the device will help you configure the IP parameters automatically as you need).

MAC Address: 00:0A:EE:20:05:A0

IP Address: 192.168.0.1

Subnet Mask: 255.255.255.0

Save

### 5. 8. 2. DHCP Client List

1. Visit <http://tplinkwifi.net>, and log in with the username and password you set for the router.
2. Go to **DHCP > DHCP Client List** to view the information of the clients connected to the router.

DHCP Clients List

This page displays information of all DHCP clients on the network.

ID	Client Name	MAC Address	Assigned IP	Lease Time
1	Camille	40:8D:5C:89:74:B5	192.168.0.100	00:00:32
2	iPhone	34:E2:FD:14:1D:0D	192.168.0.101	00:00:55

Refresh

- **Client Name** - The name of the DHCP client.
- **MAC Address** - The MAC address of the DHCP client.
- **Assigned IP** - The IP address that the router has allocated to the DHCP client.
- **Lease Time** - The time of the DHCP client leased. After the dynamic IP address has expired, a new dynamic IP address will be automatically assigned to the user.

You cannot change any of the values on this page. To update this page and show the current attached devices, click [Refresh](#).

### 5. 8. 3. Address Reservation

You can reserve an IP address for a specific client. When you specify a reserved IP address for a PC on the LAN, this PC will always receive the same IP address each time when it accesses the DHCP server.

1. Visit <http://tplinkwifi.net>, and log in with the username and password you set for the router.
2. Go to **DHCP > Address Reservation**.
3. Click [Add New](#) and fill in the blank.



MAC Address	IP Address	Status	Edit
40:8D:5C:89:74:B5	192.168.0.100	Disabled	<a href="#">Edit</a>

- 1) Enter the MAC address (in XX-XX-XX-XX-XX-XX format.) of the client for which you want to reserve an IP address.
- 2) Enter the IP address (in dotted-decimal notation) which you want to reserve for the client.
- 3) Leave the **Status** as **Enabled**.
- 4) Click **Save**.

## 5.9. System Tools

### 5.9.1. Time Settings

This page allows you to set the time manually or to configure automatic time synchronization. The Router can automatically update the time from an NTP server via the internet.

1. Visit <http://tplinkwifi.net>, and log in with the username and password you set for the router.
2. Go to **System Tools > Time Settings**.

➤ **To set time manually:**

1. Select your local **time zone**.
2. Enter the **Date** in Month/Day/Year format.

3. Enter the **Time** in Hour/Minute/Second format.
  4. Click **Save**.
- **To set time automatically:**
5. Select your local **time zone**.
  6. Enter the address or domain of the **NTP Server I** or **NTP Server II**.
  7. Click **Get GMT** to get time from the internet if you have connected to the internet.
- **To set Daylight Saving Time:**
1. Select **Enable DaylightSaving**.
  2. Select the start time from the drop-down list in the **Start** field.
  3. Select the end time from the drop-down list in the **End** field.
  4. Click **Save**.

**Daylight Saving:**

Enable Daylight Saving:

Start:      Mar ▼   Last ▼   Sun ▼   01:00 ▼

End:        Oct ▼   Last ▼   Sun ▼   02:00 ▼

**Note:**

This setting will be used for some time-based functions such as firewall. You must specify your time zone once you log in to the router successfully; otherwise, time-based functions will not take effect.

## 5.9.2. LED Control

The LED Control allows you to turn on or off the LEDs on your device according to a specific time schedule.

1. Visit <http://tplinkwifi.net>, and log in with the username and password you set for the router.
2. Go to **System Tools > LED Control**.

**LED Control**

---

Night Mode

LED Off Time    21 ▼ : 00 ▼ - 09 ▼ : 00 ▼

Before enabling the LED Control, make sure [System Time](#) is correct.

---

### 5.9.3. Diagnostic

Diagnostic is used to test the connectivity between the router and the host or other network devices.

1. Visit <http://tplinkwifi.net>, and log in with the username and password you set for the router.
2. Go to [System Tools > Diagnostic](#).

The screenshot shows the 'Diagnostic Tools' web interface. Under 'Diagnostic Parameters', the 'Diagnostic Test' is set to 'Ping' (selected with a radio button) and 'Traceroute' (unselected). A 'Start' button is to the right. Below are input fields: 'IP address/Domain name' (empty), 'Ping Count' (4), 'Ping Packet Size' (64), 'Ping Timeout' (1), and 'Traceroute Max TTL' (30). The 'Diagnostic Results' section is a large empty box.

- **Diagnostic Tool** - Select one diagnostic tool.
  - **Ping** - This diagnostic tool troubleshoots connectivity, reachability, and name resolution to a given host or gateway.
  - **Tracerouter** - This diagnostic tool tests the performance of a connection.

**Note:**

You can use ping/traceroute to test both numeric IP address or domain name. If pinging/tracerouting the IP address is successful, but pinging/tracerouting the domain name is not, you might have a name resolution problem. In this case, ensure that the domain name you are specifying can be resolved by using Domain Name System (DNS) queries.

- **IP Address/Domain Name** - Enter the destination IP address (such as 192.168.0.1) or Domain name (such as www.tp-link.com).
- **Pings Count** - The number of Ping packets for a Ping connection.
- **Ping Packet Size** - The size of Ping packet.
- **Ping Timeout** - Set the waiting time for the reply of each Ping packet. If there is no reply in the specified time, the connection is overtime.
- **Traceroute Max TTL** - The max number of hops for a Traceroute connection.

3. Click [Start](#) to check the connectivity of the internet.
4. The [Diagnostic Results](#) page displays the diagnosis result. If the result is similar to the following figure, the connectivity of the internet is fine.

```

Diagnostic Results
-----
Pinging 192.168.0.1 with 64 bytes of data:

Reply from 192.168.0.1: bytes=64 time=1 TTL=64 seq=1
Reply from 192.168.0.1: bytes=64 time=1 TTL=64 seq=2
Reply from 192.168.0.1: bytes=64 time=1 TTL=64 seq=3
Reply from 192.168.0.1: bytes=64 time=1 TTL=64 seq=4

Ping statistics for 192.168.0.1
Packets: Sent = 4, Received = 4, Lost = 0 (0% loss)
Approximate round trip times in milliseconds:
Minimum = 1, Maximum = 1, Average = 1

```

**Note:** Only one user can use this tool at one time. Options "Number of Pings", "Ping Size" and "Ping Timeout" are used for the Ping function. Option "Tracert Hops" is used for the Tracert function.

### 5.9.4. Firmware Upgrade

TP-Link is dedicated to improving and enriching the product features, giving users a better network experience. We will release the latest firmware at TP-Link official website. You can download the latest firmware file from the [Support](#) page of our website [www.tp-link.com](http://www.tp-link.com) and upgrade the firmware to the latest version.

1. Download the latest firmware file for the router from our website [www.tp-link.com](http://www.tp-link.com).
2. Visit <http://tplinkwifi.net>, and log in with the username and password you set for the router.
3. Go to [System Tools > Firmware Upgrade](#).
4. Click [Choose File](#) to locate the downloaded firmware file, and click [Upgrade](#).

**Firmware Upgrade**

---

Firmware File Path:  No file chosen

Firmware version:

Hardware version:

---

### 5.9.5. Factory Defaults

1. Visit <http://tplinkwifi.net>, and log in with the username and password you set for the router.

- Go to [System Tools](#) > [Factory Defaults](#). Click [Restore](#) to reset all settings to the default values.



- The default [Username](#): admin
- The default [Password](#): admin
- The default [IP Address](#): 192.168.0.1
- The default [Subnet Mask](#): 255.255.255.0

### 5.9.6. Backup & Restore

The configuration settings are stored as a configuration file in the router. You can backup the configuration file in your computer for future use and restore the router to the previous settings from the backup file when needed.

- Visit <http://tplinkwifi.net>, and log in with the username and password you set for the router.
- Go to [System Tools](#) > [Backup & Restore](#).

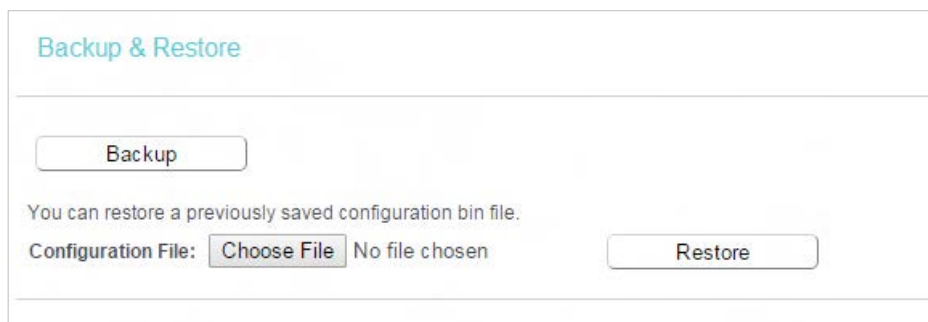

#### ➤ To backup configuration settings:

Click [Backup](#) to save a copy of the current settings in your local computer. A ".bin" file of the current settings will be stored in your computer.

#### ➤ To restore configuration settings:

- Click [Choose File](#) to locate the backup configuration file stored in your computer, and click [Restore](#).
- Wait a few minutes for the restoring and rebooting.

#### 📌 Note:

During the restoring process, do not power off or reset the router.

### 5.9.7. Reboot

- Visit <http://tplinkwifi.net>, and log in with the username and password you set for the router.

2. Go to [System Tools > Reboot](#), and you can restart your router.

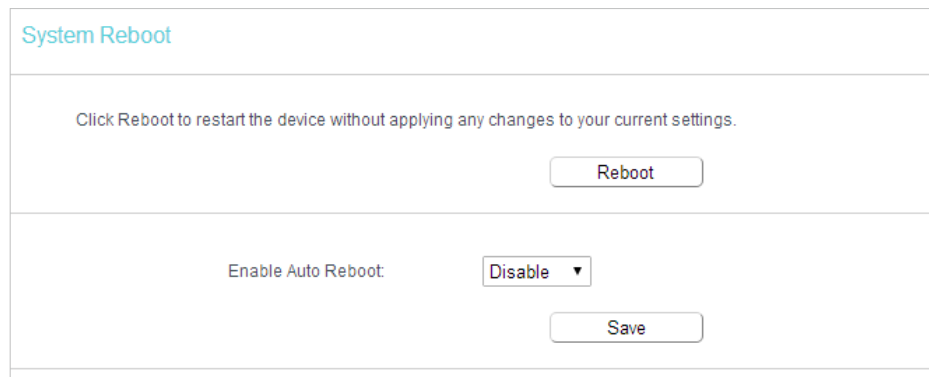

System Reboot

Click Reboot to restart the device without applying any changes to your current settings.

Reboot

Enable Auto Reboot: Disable ▾

Save

3. Enable the auto reboot function as needed.

- [Disable](#) - Disable the auto reboot function.
- [Timeout](#) - Specify a time period(1-72 hours), then the router will reboot automatically after every this interval.
- [Schedule](#) - The router will reboot automatically according to a specific time schedule.

Some settings of the router will take effect only after rebooting, including:

- Change the LAN IP Address (system will reboot automatically).
- Change the DHCP Settings.
- Change the Working Modes.
- Change the Web Management Port.
- Upgrade the firmware of the router (system will reboot automatically).
- Restore the router to its factory defaults (system will reboot automatically).
- Update the configuration with the file (system will reboot automatically).

### 5.9.8. Administrator

1. Visit <http://tplinkwifi.net>, and log in with the username and password you set for the router.

2. Go to [System Tools > Administrator](#), and you can change the factory default username and password of the router, and manage your router from a remote location via the internet.

➤ **To view and change the account settings:**

**Manage Control**

**Current User Status**

User Type: Admin  
 Username: admin  
 Host IP Address: 192.168.0.100  
 Host MAC Address: FC:AA:14:0D:23:18

**Account Management**

The username and password must not exceed 15 characters in length!

Old Password:

New User Name:

New Password:

Confirm password:

It is strongly recommended that you change the default username and password of the router, for all users that try to access the router's web management page or Quick Setup will be prompted for the router's username and password.

**Note:**

The new username and password must not exceed 15 characters and not include any spacing.

➤ **To manage your router via the internet:**

1. Specify the management web port number and click [Save](#).

**Service Configuration**

Local Management	HTTP Service	HTTPS Service	Available Host (IP/MAC)
<input type="checkbox"/>	Port: <input type="text" value="80"/>	Enable: <input checked="" type="checkbox"/> Port: <input type="text" value="443"/>	<input type="text"/>

**Certificate Download**

Local Management via HTTPS and Remote Management via HTTPS are disabled.

[Certificate Download](#)

- **Port** - The default management web port number is 80 for HTTP, 443 for HTTPS. For greater security, you can change the management web port to a number between 1024 and 65535 but do not use the number of any common service port. Tick **Enable** to enable management via HTTPS.
  - **Available Host (IP/MAC)** - This is the current address you will use when accessing your router from the internet.
  - **Certificate** - A file that provides you with authentication information. Download and install the certificate for Local Management via HTTPS if you need it. Once the certificate is installed, warnings will not pop up when you access the router via HTTPS.
2. Enter your router's WAN IP address into your browser's address bar, followed by a colon and the custom port number you set in the Web Management Port box. For example, if your Router's WAN address is 202.96.12.8 and you use port number 8080, enter `http://202.96.12.8:8080` in your browser.

### 3. Enter the router's password to access the web management page.

#### Note:

- Be sure to change the router's default password to a secure password.
- If the web management port conflicts with the one used for a Virtual Server entry, the entry will be automatically disabled after the setting is saved.

## 5.9.9. System Log

1. Visit <http://tplinkwifi.net>, and log in with the username and password you set for the router.
2. Go to **System Tools** > **System Log**, and you can view the logs of the router.



- **Log Type** - By selecting the log type, only logs of this type will be shown.
- **Log Level** - By selecting the log level, only logs of this level will be shown.
- **Refresh** - Refresh the page to show the latest log list.
- **Clear Log** - All the logs will be deleted from the router permanently, not just from the page.

## 5.10. Log Out

Click **Logout** at the bottom of the main menu, and you will log out of the web page and be directed to the login window.



## Chapter 6

---

# Configure the Router in Range Extender Mode

---

This chapter presents how to configure the various features of the router in Range Extender Mode.

It contains the following sections:

- [Status](#)
- [Quick Setup](#)
- [Operation Mode](#)
- [Network](#)
- [Dual Band Selection](#)
- [Wireless\(2.4GHz or 5GHz\)](#)
- [DHCP](#)
- [System Tools](#)
- [Log Out](#)

## 6.1. Status

1. Visit <http://tplinkwifi.net>, and log in with the username and password you set for the router.
2. Go to [Status](#). You can view the current status information of the router.

Status	
Firmware Version:	XXXXXXXXXX
Hardware Version:	Archer C20
LAN	
MAC Address:	00:0A:EB:20:05:A0
IP Address:	192.168.0.1
Subnet Mask:	255.255.255.0
Wireless 2.4GHz	
Operation Mode:	Range Extender
Wireless Radio:	Enabled
Name(SSID) of Root AP:	
Name(SSID):	TP-Link_05A0
Mode:	11bgn mixed
Channel:	Auto(Channel 1)
Channel Width:	Auto
MAC Address:	00:0A:EB:20:05:9F
WDS Status:	Disconnected
Wireless 5GHz	
Operation Mode:	Range Extender
Wireless Radio:	Enabled
Name(SSID) of Root AP:	
Name(SSID):	TP-Link_05A0_5G
Mode:	11ah/ac mixed
Channel:	Auto(Channel 36)
Channel Width:	Auto
MAC Address:	00:0A:EB:20:05:9E
WDS Status:	Disconnected
Ethernet	
Internet:	Unplugged
LAN1:	Unplugged
LAN2:	Unplugged
LAN3:	100Mbps full duplex
LAN4:	Unplugged
System Up Time: 0 day(s) 00:04:41 <input type="button" value="Refresh"/>	

- **Firmware Version** - The version information of the router's firmware.
- **Hardware Version** - The version information of the router's hardware.
- **LAN** - This field displays the current settings of the LAN, and you can configure them on the [Network > LAN](#) page.
  - **MAC address** - The physical address of the router.
  - **IP address** - The LAN IP address of the router.
  - **Subnet Mask** - The subnet mask associated with the LAN IP address.
- **Wireless 2.4GHz/5GHz** - This field displays the basic information or status of the wireless function, and you can configure them on the [Wireless > Basic Settings](#) page.
  - **Operation Mode** - The current wireless working mode in use.

- **Wireless Radio** - Indicates whether the wireless radio feature of the Router is enabled or disabled.
  - **Name(SSID)** - The SSID of the Router.
  - **Mode** - The current wireless mode which the router works on.
  - **Channel** - The current wireless channel in use.
  - **Channel Width** - The current wireless channel width in use.
  - **MAC Address** - The physical address of the router.
- **System Up Time** - The length of time since the AP was last powered on or reset. Click **Refresh** to get the latest status and settings of the AP.

## 6.2. Quick Setup

1. Visit <http://tplinkwifi.net>, and log in with the username and password you set for the router.
2. Go to **Quick Setup**.



3. Click **Next** to start. Then follow the step-by-step instructions to connect your router to the internet.

## 6.3. Operation Mode

The router supports three operation modes: Wireless Router mode, Access Point mode and Range Extender. In Range Extender mode, the device can copy and reinforce the existing wireless signal to extend the coverage of the signal, especially for a large space to eliminate signal-blind corners. To switch to Range Extender mode:



1. Place the router next to your host router and power it on.

2. Connect a computer to the router via an Ethernet cable or wirelessly by using the SSID (network name) and Wireless Password printed on the label at the bottom of the router.
3. Visit <http://tplinkwifi.net>, and log in with the username and password you set for the router.
4. Go to [Operation Mode](#).
5. Select the [Range Extender](#) mode and click [Save](#).



Operation Mode

Select an Operation Mode:

Wireless Router

Access Point

Range Extender

Save

## 6.4. Network

### 6.4.1. LAN

1. Visit <http://tplinkwifi.net>, and log in with the username and password you set for the router.
2. Go to [Network](#) > [LAN](#).
3. Configure the IP parameters of the LAN and click [Save](#).



LAN Settings

LAN Type:

Note: The IP parameters cannot be configured if you have chosen Smart IP(DHCP)  
(In this situation the device will help you configure the IP parameters automatically as you need).

MAC Address: 00:0A:EB:20:05:A0

IP Address:

Subnet Mask:

Gateway:  (optional)

Save

- **LAN Type** - Select Smart IP(DHCP) to get IP address from DHCP server, or select static IP to configure IP address manually.
- **MAC Address** - The physical address of the LAN ports. The value can not be changed.
- **IP Address** - Enter the IP address in dotted-decimal notation of your router.

- **Subnet Mask** - An address code that determines the size of the network. Normally 255.255.255.0 is used as the subnet mask.
- **Gateway (Optional)** - It is suggested to input the IP address of the LAN port of the router. The default value is 192.168.0.1.

**Note:**

- If you change the IP address, you must use the new IP address to login to the device.
- If you select the type of smart IP(DHCP), the DHCP server in this device will not startup.
- If the new IP address you set is not in the same subnet with the previous one, the IP Address pool in the DHCP server will be configured automatically.

## 6.5. Wireless(2.4GHz or 5GHz)

### 6.5.1. Connect to Host Network

1. Visit <http://tplinkwifi.net>, and log in with the username and password you set for the router.
2. Go to **Wireless > Connect to Network**.
3. Enable the **Network** function.
4. Configure the basic settings for the wireless network and click **Save**.

- **SSID(to be bridged)** - Enter the case-sensitive SSID of the host network which the extender will be connecting to, or click **Scan** and select a Wi-Fi network.
- **MAC Address(to be bridged)** - If you select **Lock to AP** checkbox, enter the MAC Address of the host network which the extender will be connecting to, or click **Scan** and select a Wi-Fi network.
- **Scan** - Click to scan and display all available Wi-Fi networks within range that you want the extender to connect to. Once a network is selected, the SSID and security settings of that network will automatically populate.
- **Security** - Select one of the security options to match with the host network.
  - **No Security** - This option disables the wireless security.

- **WPA-PSK** - This option supports implementation of the WPA (Wi-Fi Protected Access) standard. It is recommended. For **Password**, it should be between 8 and 63 characters.
- **WPA2-PSK** - This option supports implementation of the WPA2 (Wi-Fi Protected Access) standard. It is also recommended. For **Password**, it should be between 8 and 63 characters.
- **WEP** - This option is the most basic form of wireless security that can be used if your client devices can only access wireless using WEP (Wired Equivalent Privacy). Enter the matching WEP key information for your network.

### 6.5.2. Extended Network

In Range Extender mode, the device will relay data to an associated root AP. AP function is enabled meanwhile. The wireless range extender relays signal between its stations and the root AP for greater wireless range.

1. Visit <http://tplinkwifi.net>, and log in with the username and password you set for the router.
2. Go to **Wireless > Extended Network**.
3. Configure the basic settings for the network and click **Save**.

Extended Network Settings

Extended Network:  Enable

Extended 2.4GHz SSID:

Extended 2.4GHz Security:

Extended 2.4GHz Password:

Enable SSID Broadcast

- **Extended 2.4GHz SSID** - Either use the Copy Host SSID button to automatically copy the main router/AP's SSID or enter a new name (up to 32 characters long). This field is case-sensitive.
- **Copy Host SSID** - Click to copy the Host SSID. When selected, the extended network will share the SSID of your host network.
- **Extended 2.4GHz Security** - Select one of the security options to set local extended wireless network.
  - **No Security** - This option disables the wireless security.
  - **WPA-PSK/WPA2-PSK** - This option supports multiple implementation of the WPA (Wi-Fi Protected Access) standard, such as WPA and WPA2.

- **WEP** - This option is the most basic form of wireless security that can be used if your client devices can only access wireless using WEP (Wired Equivalent Privacy).
- **Enable SSID Broadcast** - If you select the Enable SSID Broadcast checkbox, the wireless router will broadcast its name (SSID) on the air.

### 6.5.3. Wireless MAC Filtering

Wireless MAC Filtering is used to deny or allow specific wireless client devices to access your network by their MAC addresses.

#### I want to:

Deny or allow specific wireless client devices to access my network by their MAC addresses.

For example, you want the wireless client A with the MAC address 00-0A-EB-B0-00-0B and the wireless client B with the MAC address 00-0A-EB-00-07-5F to access the router, but other wireless clients cannot access the router.

#### How can I do that?

1. Visit <http://tplinkwifi.net>, and log in with the username and password you set for the router.
2. Go to **Wireless > Wireless MAC Filtering**.
3. Click **Enable** to enable the Wireless MAC Filtering function.
4. Select **Allow the stations specified by any enabled entries in the list to access** as the filtering rule.
5. Delete all or disable all entries if there are any entries already.
6. Click **Add New** and fill in the blank.

The screenshot shows a web form titled "Add or Modify Wireless MAC Address Filtering entry". Below the title is a brief instruction: "You can configure Wireless MAC Filtering which allows you to control wireless access on the network on this page." The form contains three input fields: "MAC Address" with the value "00 0A EB B0 00 0B", "Description" with the value "client A", and "Status" with a dropdown menu set to "Enabled". At the bottom of the form are two buttons: "Save" and "Back".

- 1) Enter the MAC address 00-0A-EB-B0-00-0B/00-0A-EB-00-07-5F in the MAC Address field.
- 2) Enter wireless client A/B in the Description field.
- 3) Select **Enabled** in the Status drop-down list.
- 4) Click **Save** and click **Back**.

7. The configured filtering rules should be listed as the picture shows below.

Wireless MAC Filtering

You can configure Wireless MAC Filtering which allows you to control wireless access on the network on this page.

Wireless MAC Filtering:  Enabled  Disable

Filtering Rules

Deny the stations specified by any enabled entries in the list to access.

Allow the stations specified by any enabled entries in the list to access.

<input type="checkbox"/>	MAC Address	Status	Host	Description	Edit
<input checked="" type="checkbox"/>	00:0A:EB:00:00:0B	Enabled	TP-LINK_TAFF	client A	<a href="#">Edit</a>
<input checked="" type="checkbox"/>	00:0A:EB:00:07:5F	Enabled	TP-LINK_TAFF	Client B	<a href="#">Edit</a>

**Done!**

Now only client A and client B can access your network.

#### 6.5.4. Wireless Advanced

1. Visit <http://tplinkwifi.net>, and log in with the username and password you set for the router.
2. Go to [Wireless > Wireless Advanced](#).
3. Configure the advanced settings of your wireless network and click [Save](#).

**Note:**

If you are not familiar with the setting items on this page, it's strongly recommended to keep the provided default values; otherwise it may result in lower wireless network performance.

Wireless Advanced

Notice: For better performance, Fragmentation Threshold is disabled when wireless mode include 11n or 11ac.

Transmit Power:

Beacon Interval:  (25-1000)

RTS Threshold:  (1-2346)

Fragmentation Threshold:  (256-2346)

DTIM Interval:  (1-255)

Enable Short GI

Enable Client Isolation

Enable WMM

- **Transmit Power** - Select [High](#), [Middle](#) or [Low](#) which you would like to specify for the router. [High](#) is the default setting and recommended.
- **Beacon Interval** - Enter a value between 40-1000 milliseconds for Beacon Interval here. Beacon Interval value determines the time interval of the beacons. The beacons

99



are the packets sent by the router to synchronize a wireless network. The default value is 100.

- **RTS Threshold** - Here you can specify the RTS (Request to Send) Threshold. If the packet is larger than the specified RTS Threshold size, the router will send RTS frames to a particular receiving station and negotiate the sending of a data frame. The default value is 2346.
- **Fragmentation Threshold** - This value is the maximum size determining whether packets will be fragmented. Setting a low value for the Fragmentation Threshold may result in poor network performance because of excessive packets. 2346 is the default setting and is recommended.
- **DTIM Interval** - This value determines the interval of the Delivery Traffic Indication Message (DTIM). A DTIM field is a countdown field informing clients of the next window for listening to broadcast and multicast messages. When the router has buffered broadcast or multicast messages for associated clients, it sends the next DTIM with a DTIM Interval value. You can specify the value between 1-255 Beacon Intervals. The default value is 1, which indicates the DTIM Interval is the same as Beacon Interval.
- **Enable Short GI** - It is recommended to enable this function, for it will increase the data capacity by reducing the guard interval time.
- **Enable Client Isolation** - This function isolates all connected wireless stations so that wireless stations cannot access each other through WLAN.
- **Enable WMM** - WMM function can guarantee the packets with high-priority messages being transmitted preferentially. It is strongly recommended to enable this function.

### 6.5.5. Wireless Statistics

1. Visit <http://tplinkwifi.net>, and log in with the username and password you set for the router.
2. Go to **Wireless > Wireless Statistics** to check the data packets sent and received by each client device connected to the router.



ID	MAC Address	Current Status	Received Packets	Sent Packets	SSID
1	44:00:10:BF:3B:A7	Associated	29	10	tplinkwifi

- **MAC Address** - The MAC address of the connected wireless client.
- **Current Status** - The running status of the connected wireless client.
- **Received Packets** - Packets received by the wireless client.
- **Sent Packets** - Packets sent by the wireless client.

- **SSID** - SSID that the station associates with.

## 6.6. DHCP

By default, the DHCP (Dynamic Host Configuration Protocol) Server is enabled and the router acts as a DHCP server; it dynamically assigns TCP/IP parameters to client devices from the IP Address Pool. You can change the settings of DHCP Server if necessary, and you can reserve LAN IP addresses for specified client devices.

### 6.6.1. DHCP Settings

1. Visit <http://tplinkwifi.net>, and log in with the username and password you set for the router.
2. Go to **DHCP > DHCP Settings**.
3. Specify DHCP server settings and click **Save**.

DHCP Settings

DHCP Server:  Disable  Enable

Start IP Address:

End IP Address:

Address Lease Time:  minutes (1-2880 minutes, the default value is 1)

Default Gateway:  (optional)

Default Domain:  (optional)

DNS Server:  (optional)

Secondary DNS Server:  (optional)

- **DHCP Server** - Enable or disable the DHCP server. If disabled, you must have another DHCP server within your network or else you must configure the computer manually.
- **Start IP Address** - Specify an IP address for the DHCP Server to start with when assigning IP addresses. 192.168.0.100 is the default start address.
- **End IP Address** - Specify an IP address for the DHCP Server to end with when assigning IP addresses. 192.168.0.199 is the default end address.
- **Address Lease Time** - The Address Lease Time is the amount of time a network user will be allowed to connect to the router with the current dynamic IP Address. When time is up, the user will be automatically assigned a new dynamic IP address. The range of the time is 1 ~ 2880 minutes. The default value is 1.
- **Default Gateway (Optional)** - It is suggested to input the IP address of the LAN port of the router. The default value is 192.168.0.1.

- **Default Domain (Optional)** - Input the domain name of your network.
- **DNS Server (Optional)** - Input the DNS IP address provided by your ISP.
- **Secondary DNS Server (Optional)** - Input the IP address of another DNS server if your ISP provides two DNS servers.

■ **Note:**

- To use the DHCP server function of the router, you must configure all computers on the LAN as **Obtain an IP Address automatically**.
- When you choose **Smart IP (DHCP)** in **Network > LAN**, the DHCP Server function will be disabled. You will see the page as below.

The screenshot shows the 'LAN Settings' page. The 'LAN Type' is set to 'Smart IP (DHCP)'. Below this, a note states: 'Note: The IP parameters cannot be configured if you have chosen Smart IP (DHCP). (In this situation the device will help you configure the IP parameters automatically as you need).' The MAC Address is 00:0A:EB:20:05:A0. The IP Address is 192.168.0.1 and the Subnet Mask is 255.255.255.0. A 'Save' button is at the bottom.

## 6. 6. 2. DHCP Client List

1. Visit <http://tplinkwifi.net>, and log in with the username and password you set for the router.
2. Go to **DHCP > DHCP Client List** to view the information of the clients connected to the router.

The screenshot shows the 'DHCP Clients List' page. It contains a table with the following data:

ID	Client Name	MAC Address	Assigned IP	Lease Time
1	Camille	40:8D:5C:89:74:B5	192.168.0.100	00:00:32
2	iPhone	34:E2:FD:14:1D:0D	192.168.0.101	00:00:55

A 'Refresh' button is located at the bottom of the table.

- **Client Name** - The name of the DHCP client.
- **MAC Address** - The MAC address of the DHCP client.
- **Assigned IP** - The IP address that the router has allocated to the DHCP client.
- **Lease Time** - The time of the DHCP client leased. After the dynamic IP address has expired, a new dynamic IP address will be automatically assigned to the user.

You cannot change any of the values on this page. To update this page and show the current attached devices, click **Refresh**.

## 6.7. System Tools

### 6.7.1. Time Settings

This page allows you to set the time manually or to configure automatic time synchronization. The Router can automatically update the time from an NTP server via the internet.

1. Visit <http://tplinkwifi.net>, and log in with the username and password you set for the router.
2. Go to [System Tools](#) > [Time Settings](#).

Time Settings

Time Settings:

Time Zone: (GMT-08:00) Pacific Time (US & Canada); Tijuana

Date: 1970 Year 1 Month 1 Day

Time: 0 Hour 42 Minute 40 Second

NTP Server 1:  (optional)

NTP Server 2:  (optional)

(Only when the internet connection is active).

➤ **To set time manually:**

1. Select your local [time zone](#).
2. Enter the [Date](#) in Month/Day/Year format.
3. Enter the [Time](#) in Hour/Minute/Second format.
4. Click [Save](#).

➤ **To set time automatically:**

5. Select your local [time zone](#).
6. Enter the address or domain of the [NTP Server I](#) or [NTP Server II](#).
7. Click [Get GMT](#) to get time from the internet if you have connected to the internet.

➤ **To set Daylight Saving Time:**

1. Select [Enable Daylight Saving](#).
2. Select the start time from the drop-down list in the [Start](#) field.
3. Select the end time from the drop-down list in the [End](#) field.
4. Click [Save](#).

Daylight Saving:

Enable Daylight Saving:

Start: Mar Last Sun 01:00

End: Oct Last Sun 02:00

Save

**Note:**

This setting will be used for some time-based functions such as firewall. You must specify your time zone once you log in to the router successfully; otherwise, time-based functions will not take effect.

### 6.7.2. LED Control

The LED Control allows you to turn on or off the LEDs on your device according to a specific time schedule.

1. Visit <http://tplinkwifi.net>, and log in with the username and password you set for the router.
2. Go to [System Tools > LED Control](#).

LED Control

Night Mode

LED Off Time 21 : 00 - 09 : 00

Before enabling the LED Control, make sure [System Time](#) is correct.

Save

### 6.7.3. Diagnostic

Diagnostic is used to test the connectivity between the router and the host or other network devices.

1. Visit <http://tplinkwifi.net>, and log in with the username and password you set for the router.
2. Go to [System Tools > Diagnostic](#).

The screenshot shows a web interface for diagnostic tools. Under 'Diagnostic Parameters', there are radio buttons for 'Ping' (selected) and 'Traceroute', and a 'Start' button. Below these are several input fields: 'IP address/Domain name' (empty), 'Ping Count' (4), 'Ping Packet Size' (64), 'Ping Timeout' (1), and 'Traceroute Max TTL' (30). The 'Diagnostic Results' section is a large empty box.

- **Diagnostic Tool** - Select one diagnostic tool.
  - **Ping** - This diagnostic tool troubleshoots connectivity, reachability, and name resolution to a given host or gateway.
  - **Tracerouter** - This diagnostic tool tests the performance of a connection.

**Note:**

You can use ping/traceroute to test both numeric IP address or domain name. If pinging/tracerouting the IP address is successful, but pinging/tracerouting the domain name is not, you might have a name resolution problem. In this case, ensure that the domain name you are specifying can be resolved by using Domain Name System (DNS) queries.

- **IP Address/Domain Name** - Enter the destination IP address (such as 192.168.0.1) or Domain name (such as www.tp-link.com).
  - **Pings Count** - The number of Ping packets for a Ping connection.
  - **Ping Packet Size** - The size of Ping packet.
  - **Ping Timeout** - Set the waiting time for the reply of each Ping packet. If there is no reply in the specified time, the connection is overtime.
  - **Traceroute Max TTL** - The max number of hops for a Traceroute connection.
3. Click **Start** to check the connectivity of the internet.
  4. The **Diagnostic Results** page displays the diagnosis result. If the result is similar to the following figure, the connectivity of the internet is fine.

```

Diagnostic Results
-----
Pinging 192.168.0.1 with 64 bytes of data:

Reply from 192.168.0.1: bytes=64 time=1 TTL=64 seq=1
Reply from 192.168.0.1: bytes=64 time=1 TTL=64 seq=2
Reply from 192.168.0.1: bytes=64 time=1 TTL=64 seq=3
Reply from 192.168.0.1: bytes=64 time=1 TTL=64 seq=4

Ping statistics for 192.168.0.1
Packets: Sent = 4, Received = 4, Lost = 0 (0% loss)
Approximate round trip times in milliseconds:
Minimum = 1, Maximum = 1, Average = 1

```

**Note:** Only one user can use this tool at one time. Options “Number of Pings”, “Ping Size” and “Ping Timeout” are used for the Ping function. Option “Tracert Hops” is used for the Tracert function.

### 6. 7. 4. Firmware Upgrade

TP-Link is dedicated to improving and enriching the product features, giving users a better network experience. We will release the latest firmware at TP-Link official website. You can download the latest firmware file from the [Support](#) page of our website [www.tp-link.com](http://www.tp-link.com) and upgrade the firmware to the latest version.

1. Download the latest firmware file for the router from our website [www.tp-link.com](http://www.tp-link.com).
2. Visit <http://tplinkwifi.net>, and log in with the username and password you set for the router.
3. Go to [System Tools > Firmware Upgrade](#).
4. Click [Choose File](#) to locate the downloaded firmware file, and click [Upgrade](#).

**Firmware Upgrade**

---

Firmware File Path:  No file chosen

Firmware version:

Hardware version:

---

### 6. 7. 5. Factory Defaults

1. Visit <http://tplinkwifi.net>, and log in with the username and password you set for the router.
2. Go to [System Tools > Factory Defaults](#). Click [Restore](#) to reset all settings to the default values.



- The default **Username**: admin
- The default **Password**: admin
- The default **IP Address**: 192.168.0.1
- The default **Subnet Mask**: 255.255.255.0

### 6.7.6. Backup & Restore

The configuration settings are stored as a configuration file in the router. You can backup the configuration file in your computer for future use and restore the router to the previous settings from the backup file when needed.

1. Visit <http://tplinkwifi.net>, and log in with the username and password you set for the router.
2. Go to **System Tools > Backup & Restore**.

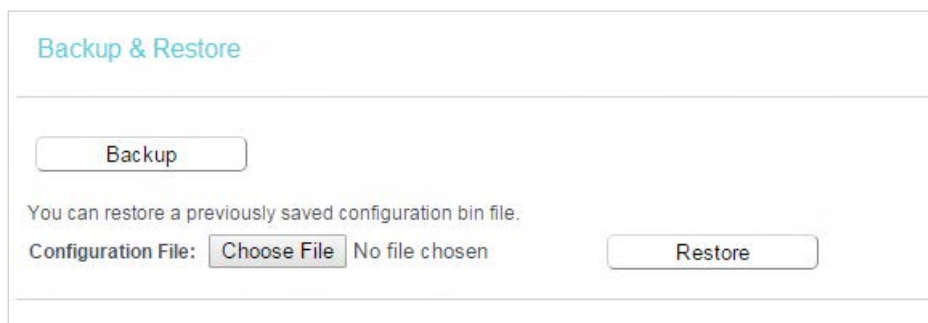

#### ➤ To backup configuration settings:

Click **Backup** to save a copy of the current settings in your local computer. A ".bin" file of the current settings will be stored in your computer.

#### ➤ To restore configuration settings:

1. Click **Choose File** to locate the backup configuration file stored in your computer, and click **Restore**.
2. Wait a few minutes for the restoring and rebooting.

#### 📌 Note:

During the restoring process, do not power off or reset the router.

### 6.7.7. Reboot

1. Visit <http://tplinkwifi.net>, and log in with the username and password you set for the router.
2. Go to **System Tools > Reboot**, and you can restart your router.



System Reboot

Click Reboot to restart the device without applying any changes to your current settings.

Reboot

Enable Auto Reboot: Disable ▾

Save

3. Enable the auto reboot function as needed.

- **Disable** - Disable the auto reboot function.
- **Timeout** - Specify a time period(1-72 hours), then the router will reboot automatically after every this interval.
- **Schedule** - The router will reboot automatically according to a specific time schedule.

Some settings of the router will take effect only after rebooting, including:

- Change the LAN IP Address (system will reboot automatically).
- Change the DHCP Settings.
- Change the Working Modes.
- Change the Web Management Port.
- Upgrade the firmware of the router (system will reboot automatically).
- Restore the router to its factory defaults (system will reboot automatically).
- Update the configuration with the file (system will reboot automatically).

### 6. 7. 8. Administrator

1. Visit <http://tplinkwifi.net>, and log in with the username and password you set for the router.
2. Go to **System Tools > Administrator**, and you can change the factory default username and password of the router, and manage your router from a remote location via the internet.

➤ **To view and change the account settings:**

**Manage Control**

**Current User Status**

User Type: Admin  
 Username: admin  
 Host IP Address: 192.168.0.100  
 Host MAC Address: FC:AA:14:0D:23:18

**Account Management**

The username and password must not exceed 15 characters in length!

Old Password:

New User Name:

New Password:

Confirm password:

It is strongly recommended that you change the default username and password of the router, for all users that try to access the router's web management page or Quick Setup will be prompted for the router's username and password.

**Note:**

The new username and password must not exceed 15 characters and not include any spacing.

➤ **To manage your router via the internet:**

1. Specify the management web port number and click [Save](#).

**Service Configuration**

Local Management	HTTP Service	HTTPS Service	Available Host (IP/MAC)
<input type="checkbox"/>	Port: 80	Enable <input type="checkbox"/> Port: 443	<input type="text"/>

**Certificate Download**

Local Management via HTTPS and Remote Management via HTTPS are disabled.

[Certificate Download](#)

- **Port** - The default management web port number is 80 for HTTP, 443 for HTTPS. For greater security, you can change the management web port to a number between 1024 and 65535 but do not use the number of any common service port. Tick **Enable** to enable management via HTTPS.
  - **Available Host (IP/MAC)** - This is the current address you will use when accessing your router from the internet.
  - **Certificate** - A file that provides you with authentication information. Download and install the certificate for Local Management via HTTPS if you need it. Once the certificate is installed, warnings will not pop up when you access the router via HTTPS.
2. Enter your router's WAN IP address into your browser's address bar, followed by a colon and the custom port number you set in the Web Management Port box. For

example, if your Router's WAN address is 202.96.12.8 and you use port number 8080, enter <http://202.96.12.8:8080> in your browser.

3. Enter the router's password to access the web management page.

**Note:**

- Be sure to change the router's default password to a secure password.
- If the web management port conflicts with the one used for a Virtual Server entry, the entry will be automatically disabled after the setting is saved.

### 6.7.9. System Log

1. Visit <http://tplinkwifi.net>, and log in with the username and password you set for the router.

2. Go to **System Tools** > **System Log**, and you can view the logs of the router.



The screenshot shows the 'System Log' interface. At the top, there are two dropdown menus: 'Log Type' set to 'ALL' and 'Log Level' set to 'Debug'. Below these is a table with the following data:

Index	Time	Type	Level	Content
1	1970-01-01 00:00:00	DHCPD	Notice	Send ACK to 192.168.0.100
2	1970-01-01 00:00:00	DHCPD	Notice	Recv REQUEST from 40:8D:5C:89:74:85

At the bottom of the interface, there are four buttons: 'Refresh', 'Clear Log', 'Save Log', and 'Log Settings'.

- **Log Type** - By selecting the log type, only logs of this type will be shown.
- **Log Level** - By selecting the log level, only logs of this level will be shown.
- **Refresh** - Refresh the page to show the latest log list.
- **Clear Log** - All the logs will be deleted from the router permanently, not just from the page.

### 6.8. Log Out

Click **Logout** at the bottom of the main menu, and you will log out of the web page and be directed to the login window.

# FAQ

## Q1. What should I do if I forget my wireless password?

The default wireless password is printed on the label of the router. If the password has been altered, please connect your computer to the router using an Ethernet cable and follow the steps below:

1. Visit <http://tplinkwifi.net>, and log in with the username and password you set for the router.
2. Go to [Wireless > Wireless Security](#) to retrieve or reset your wireless password.

## Q2. What should I do if I forget my login password of the web management page?

The default username and password of the web management page are [admin](#) (in lowercase).

**If you have altered the username and password but Password Recovery is disabled:**

1. Reset the router to factory default settings: press and hold the Reset button until all LEDs turn off and then release the button;
2. Visit <http://tplinkwifi.net>, and enter [admin](#) (in lowercase) as both username and password to log in.

**Note:** You'll need to reconfigure the router to surf the internet once the router is reset, and please mark down your new password for future use.

## Q3. What should I do if I cannot log in to the router's web management page?

1. This can happen for a variety of reasons. Please try the methods below to log in again.
  - Make sure your computer has connected to the router correctly and the corresponding LED lights up.
  - Make sure the IP address of your computer is configured as [Obtain an IP address automatically](#) and [Obtain DNS server address automatically](#).
2. Make sure you enter the correct IP address to log in: <http://tplinkwifi.net>.
  - Check your computer's settings:
3. Go to [Start > Control Panel > Network and Internet](#), and click [View network status and tasks](#).
  - 1) Click [Internet Options](#) on the bottom left.
  - 2) Click [Connections](#) and select [Never dial a connection](#).

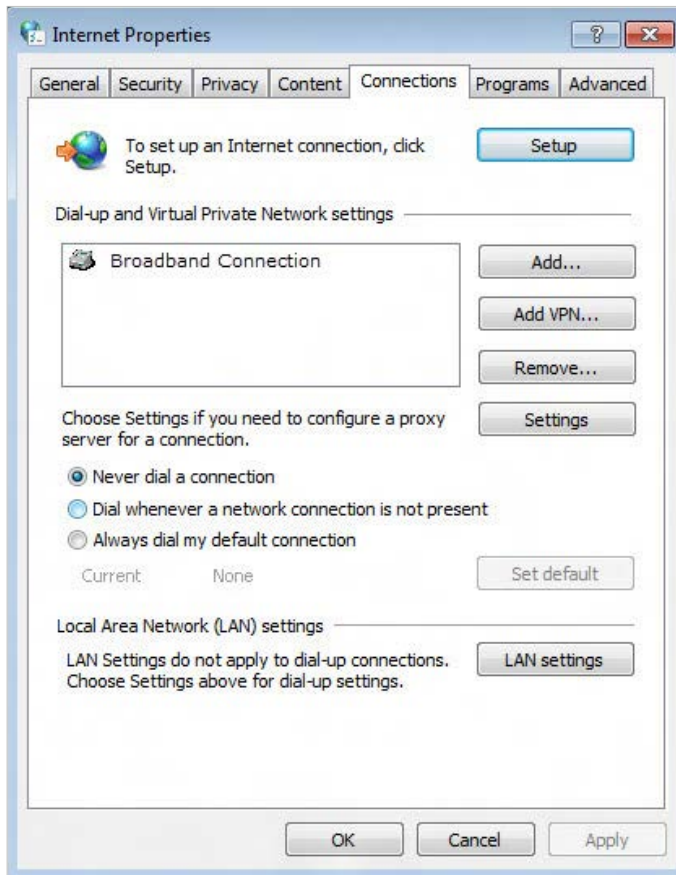

3) Click [LAN settings](#) and deselect the following three options, and click [OK](#).



- 4) Go to **Advanced** > **Restore advanced settings**, and click **OK** to save the settings.

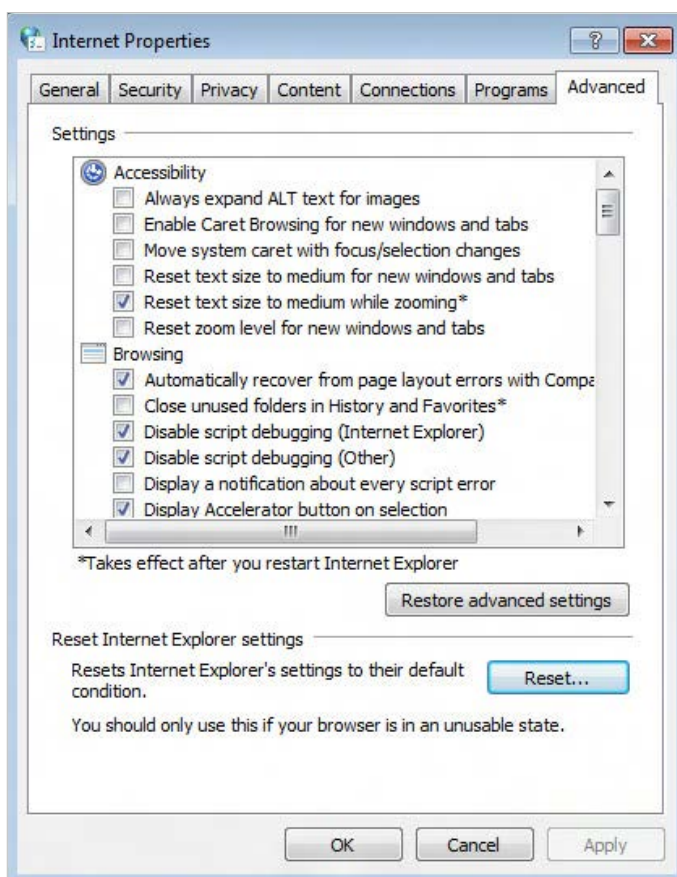

- Use another web browser or computer to log in again.
- Reset the router to factory default settings and try again. If the login still fails, please contact the technical support.

■ **Note:** You'll need to reconfigure the router to surf the internet once the router is reset.

#### Q4. What should I do if I cannot access the internet even though the configuration is finished?

1. Visit <http://tplinkwifi.net>, and log in to with the username and password you set for the router.
2. Go to **Status** to check WAN status:

**If IP Address is a valid one, please try the methods below and try again:**

- Your computer might not recognize any DNS server addresses, please manually configure DNS server.
  - 1) Go to **DHCP**.
  - 2) Enter 8.8.8.8 as Primary DNS, and click **Save**.

🔗 **Tips:** 8.8.8.8 is a safe and public DNS server operated by Google.

### DHCP Settings

DHCP Server:  Disable  Enable

Start IP Address:

End IP Address:

Address Lease Time:  minutes (1~2000 minutes, the default value is 120)

Default Gateway:

Default Domain:  (Optional)

Primary DNS:  (Optional)

Secondary DNS:  (Optional)

The change of DHCP config will not take effect until this device reboots, please [click here](#) to reboot.

- Restart the modem and the router.
  - 1) Power off your modem and the router, and leave them off for 1 minute.
  - 2) Power on your modem first, and wait about 2 minutes.
  - 3) Power on the router, and wait another 1 or 2 minutes and check the internet access.
- Reset the router to factory default settings and reconfigure the router.
- Upgrade the firmware of the router.
- Check the TCP/IP settings on the particular device if all other devices can get internet from the router.

**If the IP Address is 0.0.0.0, please try the methods below and try again:**

- Make sure the physical connection between the router and the modem is proper.
- Clone the MAC address of your computer.
  - 1) Visit <http://tplinkwifi.net>, and log in with the username and password you set for the router.
  - 2) Go to **Network > MAC Clone**, select **Clone MAC Address** and click **Save**.

### MAC Clone

WAN MAC Address:

Your PC's MAC Address:

**Tips:**

- Some ISP will register the MAC address of your computer when you access the internet for the first time through their Cable modem, if you add a router into your network to share your internet connection, the ISP will not accept it as the MAC address is changed, so we need to clone your computer's MAC address to the router.

- The MAC addresses of a computer in wired connection and wireless connection are different.

- **Modify the LAN IP address of the router.**

**Note:**

Most TP-Link routers use 192.168.0.1/192.168.1.1 as their default LAN IP address, it may conflict with the IP range of your existent ADSL modem/router. If so, the router is not able to communicate with your modem and cause you can't access the internet. To resolve this problem, we need to change the LAN IP address of the router to avoid such conflict, for example, 192.168.2.1.

- 1) Visit <http://tplinkwifi.net>, and log in with the username and password you set for the router.
- 2) Go to [Network > LAN](#).
- 3) Modify the LAN IP address as the follow picture shows. Here we take 192.168.2.1 as an example.
- 4) Click [Save](#).

LAN

MAC Address: 0C-4A-08-45-F3-6D

IP Address: 192.168.2.1

Subnet Mask: 255.255.255.0

IGMP Proxy: Enable

Note: IGMP (Internet Group Management Protocol) works for IPTV multicast stream. The device supports both IGMP proxy with enabled/disabled option and IGMP snooping.

Save

- Restart the modem and the router.
  - 1) Power off your modem and the router, and leave them off for 1 minute.
  - 2) Power on your modem first, and wait about 2 minutes.
  - 3) Power on the router, and wait another 1 or 2 minutes and check the internet access.
- Double check the internet Connection Type.
  - 1) Confirm your internet Connection Type, which can be learned from the ISP.
  - 2) Visit <http://tplinkwifi.net>, and log in with the username and password you set for the router.
  - 3) Go to [Network > WAN](#).
  - 4) Select your [WAN Connection Type](#) and fill in other parameters.
  - 5) Click [Save](#).



WAN

WAN Connection Type:

IP Address:

Subnet Mask:

Default Gateway:

MTU Size (in bytes):  (The default is 1500, do not change unless necessary.)

Use These DNS Servers

Primary DNS:

Secondary DNS:  (Optional)

Host Name:

Get IP with Unicast DHCP (it is usually not required.)

6) Restart the modem and the router.

- Please upgrade the firmware of the router.

If you've tried every method above but cannot access the internet, please contact the technical support.

## Q5. What should I do if I cannot find my wireless network or I cannot connect the wireless network?

If you fail to find any wireless network, please follow the steps below:

- Make sure the wireless function of your device is enabled if you're using a laptop with a built-in wireless adapter. You can refer to the relevant document or contact the laptop manufacturer.
- Make sure the wireless adapter driver is installed successfully and the wireless adapter is enabled.
  - **On Windows 7**
    - 1) If you see the message [No connections are available](#), it is usually because the wireless function is disabled or blocked somehow.
    - 2) Clicking [Troubleshoot](#) and windows might be able to fix the problem by itself.
  - **On Windows XP**
    - 1) If you see the message [Windows cannot configure this wireless connection](#), this is usually because windows configuration utility is disabled or you are running another wireless configuration tool to connect the wireless.
    - 2) Exit the wireless configuration tool (the TP-Link Utility, for example).

- 3) Select and right click [My Computer](#) on Desktop, and select [Manage](#) to open Computer Management window.
- 4) Expand [Services and Applications](#) > [Services](#), and find and locate [Wireless Zero Configuration](#) in the Services list on the right side.
- 5) Right click [Wireless Zero Configuration](#), and then select [Properties](#).
- 6) Change [Startup type](#) to [Automatic](#), click [Start](#) and make sure the Service status is [Started](#). And then click [OK](#).

**If you can find other wireless network except your own, please follow the steps below:**

- Check the WLAN LED indicator on your wireless router/modem.
- Make sure your computer/device is still in the range of your router/modem. Move closer if it is currently too far away.

**If you can find your wireless network but fail to connect, please follow the steps below:**

- **Authenticating problem/password mismatch:**
  - 1) Sometimes you will be asked to type in a PIN number when you connect to the wireless network for the first time. This PIN number is different from the Wireless Password/Network Security Key. Usually you can only find it on the label of your router.



- 2) If you cannot find the PIN or PIN failed, you may choose [Connecting using a security key instead](#), and then type in the [Wireless Password/Network Security Key](#).
- 3) If it continues to show note of [Network Security Key Mismatch](#), it is suggested to confirm the wireless password of your wireless router.

**Note:** Wireless Password/Network Security Key is case sensitive.

- **Windows unable to connect to XXXX / Can not join this network / Taking longer than usual to connect to this network:**
  - Check the wireless signal strength of your network, if it is weak (1~3 bars), please move the router closer and try again.

- Change the wireless Channel of the router to 1,6,or 11 to reduce interference from other networks.
- Re-install or update the driver for your wireless adapter of the computer.

## COPYRIGHT & TRADEMARKS

Specifications are subject to change without notice.  tp-link is a registered trademark of TP-Link Technologies Co., Ltd. Other brands and product names are trademarks or registered trademarks of their respective holders.

No part of the specifications may be reproduced in any form or by any means or used to make any derivative such as translation, transformation, or adaptation without permission from TP-Link Technologies Co., Ltd. Copyright © 2019 TP-Link Technologies Co., Ltd. All rights reserved.

## FCC compliance information statement



**Product Name: AC750 Wireless Dual Band Router**

**Model Number: Archer C20 / Archer A2**

Component Name	Model
I.T.E POWER SUPPLY	T120100-2B1

### **Responsible party:**

**TP-Link USA Corporation, d/b/a TP-Link North America, Inc.**

Address: 145 South State College Blvd. Suite 400, Brea, CA 92821

Website: <http://www.tp-link.com/us/>

Tel: +1 626 333 0234

Fax: +1 909 527 6803

E-mail: [sales.usa@tp-link.com](mailto:sales.usa@tp-link.com)

This equipment has been tested and found to comply with the limits for a Class B digital device, pursuant to part 15 of the FCC Rules. These limits are designed to provide reasonable protection against harmful interference in a residential installation. This equipment generates, uses and can radiate radio frequency energy and, if not installed and used in accordance with the instructions, may cause harmful interference to radio communications. However, there is no guarantee that interference will not occur in a particular installation. If this equipment does cause harmful interference to radio or television reception, which can be determined by turning the equipment off and on, the user is encouraged to try to correct the interference by one or more of the following measures:

- Reorient or relocate the receiving antenna.
- Increase the separation between the equipment and receiver.
- Connect the equipment into an outlet on a circuit different from that to which the receiver is connected.
- Consult the dealer or an experienced radio/ TV technician for help.

This device complies with part 15 of the FCC Rules. Operation is subject to the following two conditions:

1. This device may not cause harmful interference.
2. This device must accept any interference received, including interference that may cause undesired operation.

Any changes or modifications not expressly approved by the party responsible for compliance could void the user's authority to operate the equipment.

Note: The manufacturer is not responsible for any radio or TV interference caused by unauthorized modifications to this equipment. Such modifications could void the user's authority to operate the equipment.

### **FCC RF Radiation Exposure Statement**

This equipment complies with FCC RF radiation exposure limits set forth for an uncontrolled environment. This device and its antenna must not be co-located or operating in conjunction with any other antenna or transmitter.

"To comply with FCC RF exposure compliance requirements, this grant is applicable to only Mobile Configurations. The antennas used for this transmitter must be installed to provide a separation distance of at least 20 cm from all persons and must not be co-located or operating in conjunction with any other antenna or transmitter."

We, **TP-Link USA Corporation**, has determined that the equipment shown as above has been shown to comply with the applicable technical standards, FCC part 15. There is no unauthorized change is made in the equipment and the equipment is properly maintained and operated.

Issue Date: 2018.12.29

### **FCC compliance information statement**



**Product Name: I.T.E POWER SUPPLY**

**Model Number: T120100-2B1**

**Responsible party:**

**TP-Link USA Corporation, d/b/a TP-Link North America, Inc.**

Address: 145 South State College Blvd. Suite 400, Brea, CA 92821

Website: <http://www.tp-link.com/us/>

Tel: +1 626 333 0234

Fax: +1 909 527 6803

E-mail: [sales.usa@tp-link.com](mailto:sales.usa@tp-link.com)

This equipment has been tested and found to comply with the limits for a Class B digital device, pursuant to part 15 of the FCC Rules. These limits are designed to provide reasonable protection against harmful interference in a residential installation. This equipment generates, uses and can radiate radio frequency energy and, if not installed and used in accordance with the instructions, may cause harmful interference to radio communications. However, there is no guarantee that interference will not occur in a particular installation. If this equipment does cause harmful interference to radio or television reception, which can be determined by turning the equipment off and on, the

user is encouraged to try to correct the interference by one or more of the following measures:

- Reorient or relocate the receiving antenna.
- Increase the separation between the equipment and receiver.
- Connect the equipment into an outlet on a circuit different from that to which the receiver is connected.
- Consult the dealer or an experienced radio/ TV technician for help.

This device complies with part 15 of the FCC Rules. Operation is subject to the following two conditions:

1. This device may not cause harmful interference.
2. This device must accept any interference received, including interference that may cause undesired operation.

Any changes or modifications not expressly approved by the party responsible for compliance could void the user's authority to operate the equipment.

We, **TP-Link USA Corporation**, has determined that the equipment shown as above has been shown to comply with the applicable technical standards, FCC part 15. There is no unauthorized change is made in the equipment and the equipment is properly maintained and operated.

Issue Date: 2018.12.29

## CE Mark Warning



This is a class B product. In a domestic environment, this product may cause radio interference, in which case the user may be required to take adequate measures.

### OPERATING FREQUENCY(the maximum transmitted power)

2400 MHz -2483.5 MHz(20dBm)

5150 MHz -5250 MHz(23dBm)

### EU declaration of conformity

TP-Link hereby declares that the device is in compliance with the essential requirements and other relevant provisions of directives 2014/53/EU, 2009/125/EC and 2011/65/EU.

The original EU declaration of conformity may be found at <https://www.tp-link.com/en/ce>.

### RF Exposure Information

This device meets the EU requirements (2014/53/EU Article 3.1a) on the limitation of exposure of the general public to electromagnetic fields by way of health protection.

The device complies with RF specifications when the device used at 20 cm from your body.

### National restrictions

Attention: This device may only be used indoors in all EU member states and EFTA countries.

	AT	BE	BG	CH	CY	CZ	DE	DK
	EE	EL	ES	FI	FR	HR	HU	IE
	IS	IT	LI	LT	LU	LV	MT	NL
	NO	PL	PT	RO	SE	SI	SK	UK

### Canadian Compliance Statement

This device complies with Industry Canada license-exempt RSSs. Operation is subject to the following two conditions:

- 1) This device may not cause interference, and
- 2) This device must accept any interference, including interference that may cause undesired operation of the device.

Le présent appareil est conforme aux CNR d'Industrie Canada applicables aux appareils radio exempts de licence. L'exploitation est autorisée aux deux conditions suivantes :

- 1) l'appareil ne doit pas produire de brouillage;



- 2) l'utilisateur de l'appareil doit accepter tout brouillage radioélectrique subi, même si le brouillage est susceptible d'en compromettre le fonctionnement.

### **Caution:**

- 1) The device for operation in the band 5150–5250 MHz is only for indoor use to reduce the potential for harmful interference to co-channel mobile satellite systems;
- 2) For devices with detachable antenna(s), the maximum antenna gain permitted for devices in the band 5725-5850 MHz shall be such that the equipment still complies with the e.i.r.p. limits specified for point-to-point and non-point-to-point operation as appropriate; and

The high-power radars are allocated as primary users (i.e. priority users) of the bands 5250-5350 MHz and 5650-5850 MHz and that these radars could cause interference and/or damage to LE-LAN devices.

### **Avertissement:**

- 1) Le dispositif fonctionnant dans la bande 5150-5250 MHz est réservé uniquement pour une utilisation à l'intérieur afin de réduire les risques de brouillage préjudiciable aux systèmes de satellites mobiles utilisant les mêmes canaux;
- 2) Le gain maximal d'antenne permis pour les dispositifs avec antenne(s) amovible(s) utilisant la bande 5725-5850 MHz doit se conformer à la limitation P.I.R.E spécifiée pour l'exploitation point à point et non point à point, selon le cas.

En outre, les utilisateurs devraient aussi être avisés que les utilisateurs de radars de haute puissance sont désignés utilisateurs principaux (c.-à-d., qu'ils ont la priorité) pour les bandes 5250-5350 MHz et 5650-5850 MHz et que ces radars pourraient causer du brouillage et/ou des dommages aux dispositifs LAN-EL.

### **Radiation Exposure Statement:**

This equipment complies with IC radiation exposure limits set forth for an uncontrolled environment. This equipment should be installed and operated with minimum distance 20cm between the radiator & your body.

### **Déclaration d'exposition aux radiations:**

Cet équipement est conforme aux limites d'exposition aux rayonnements IC établies pour un environnement non contrôlé. Cet équipement doit être installé et utilisé avec un minimum de 20 cm de distance entre la source de rayonnement et votre corps.

### **Industry Canada Statement**

CAN ICES-3 (B)/NMB-3(B)

### **Korea Warning Statements**

당해 무선설비는 운용중 전파혼신 가능성이 있음.

## NCC Notice

注意！

依據 低功率電波輻射性電機管理辦法

第十二條 經型式認證合格之低功率射頻電機，非經許可，公司、商號或使用者均不得擅自變更頻率、加大功率或變更原設計之特性或功能。

第十四條 低功率射頻電機之使用不得影響飛航安全及干擾合法通行；經發現有干擾現象時，應立即停用，並改善至無干擾時方得繼續使用。前項合法通信，指依電信規定作業之無線電信。低功率射頻電機需忍受合法通信或工業、科學以及醫療用電波輻射性電機設備之干擾。

4.7.9.1 應避免影響附近雷達系統之操作。

4.7.9.2 高增益指向性天線只得應用於固定式點對點系統。

## BSMI Notice

安全諮詢及注意事項

- 請使用原裝電源供應器或只能按照本產品注明的電源類型使用本產品。
- 清潔本產品之前請先拔掉電源線。請勿使用液體、噴霧清潔劑或濕布進行清潔。
- 注意防潮，請勿將水或其他液體潑灑到本產品上。
- 插槽與開口供通風使用，以確保本產品的操作可靠並防止過熱，請勿堵塞或覆蓋開口。
- 請勿將本產品置放於靠近熱源的地方。除非有正常的通風，否則不可放在密閉位置中。
- 請不要私自打開機殼，不要嘗試自行維修本產品，請由授權的專業人士進行此項工作。

限用物質含有情況標示聲明書

產品元件 名稱	限用物質及其化學符號					
	鉛 Pb	鎘 Cd	汞 Hg	六價鉻 CrVI	多溴聯苯 PBB	多溴二苯醚 PBDE
PCB	○	○	○	○	○	○
外殼	○	○	○	○	○	○
電源適配器	—	○	○	○	○	○

備考1. “超出0.1wt%”及“超出0.01wt%”系指限用物質之百分比含量超出百分比含量基準值。  
備考2. “○”系指該項限用物質之百分比含量未超出百分比含量基準值。  
備考3. “—”系指該項限用物質為排除項目。



Продукт сертифіковано згідно с правилами системи УкрСЕПРО на відповідність

вимогам нормативних документів та вимогам, що передбачені чинними законодавчими актами України.





## Safety Information

- Keep the device away from water, fire, humidity or hot environments.
- Do not attempt to disassemble, repair, or modify the device.
- Do not use damaged charger or USB cable to charge the device.
- Do not use any other chargers than those recommended
- Do not use the device where wireless devices are not allowed.
- Adapter shall be installed near the equipment and shall be easily accessible.
-  Use only power supplies which are provided by manufacturer and in the original packing of this product. If you have any questions, please don't hesitate to contact us.

Please read and follow the above safety information when operating the device. We cannot guarantee that no accidents or damage will occur due to improper use of the device. Please use this product with care and operate at your own risk.

## Explanations of the symbols on the product label

Symbol	Explanation
	DC voltage
	Indoor use only
	<b>RECYCLING</b> This product bears the selective sorting symbol for Waste electrical and electronic equipment (WEEE). This means that this product must be handled pursuant to European directive 2012/19/EU in order to be recycled or dismantled to minimize its impact on the environment. User has the choice to give his product to a competent recycling organization or to the retailer when he buys a new electrical or electronic equipment.