





AC1200 Wireless Access Point

Dual Band & Gigabit Port



TL-WA1201

 867 Mbps 5 GHz
300 Mbps 2.4 GHz†

 Flexible Deployment
with Passive PoE

 Beamforming for
Greater Coverage

 Captive Portal
Marketing

Highlights

Multiple Operation modes

TL-WA1201 supports multiple operation modes: Access Point, Client, Range Extender and Multi-SSID (VLAN Support) modes to meet any network need.

Access Point Mode (Default Mode)

Transform your existing wired network into a wireless network

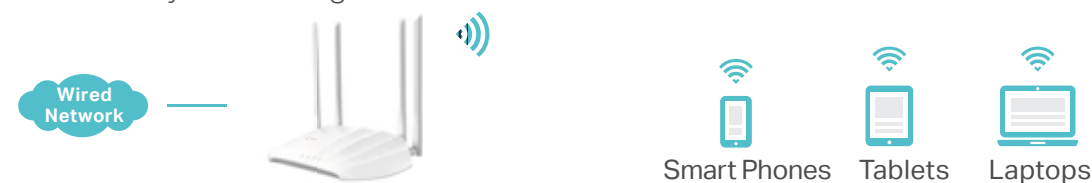

Range Extender Mode

Extend your existing wireless coverage by repeating the wireless signal

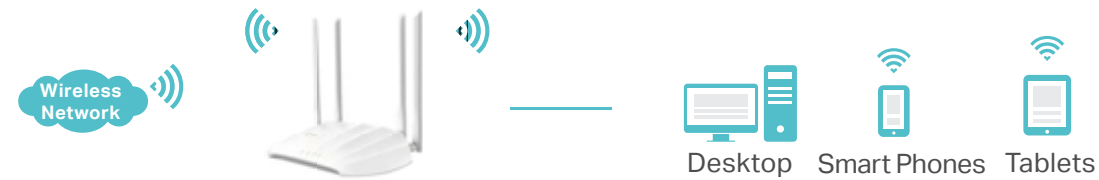

Client Mode

Acting as a "Wireless Adapter" to connect your wired devices (e.g. Xbox/PS3) to a wireless network



Multi-SSID Mode

Simultaneously supports up to four separate SSIDs and VLANs on each band, making it ideal for offices where different departments with different access policies share a wireless network



Captive Portal Marketing, Designed for Small Businesses

Captive Portal offers unique marketing opportunities, especially for small businesses like cafes or pharmacies. Utilize a flexibly designed portal page—requiring customers to view an advertisement or accept a set terms for internet access—to improve brand awareness or deliver marketing messages.



TP-Link AC1200 Wireless Access Point TL-WA1201

Highlights

Passive PoE for More Flexible Deployment

The TL-WA1201 can be powered using an Ethernet cable to simultaneously send data and electricity to wherever your Access Point may be located even up to 100 feet away.

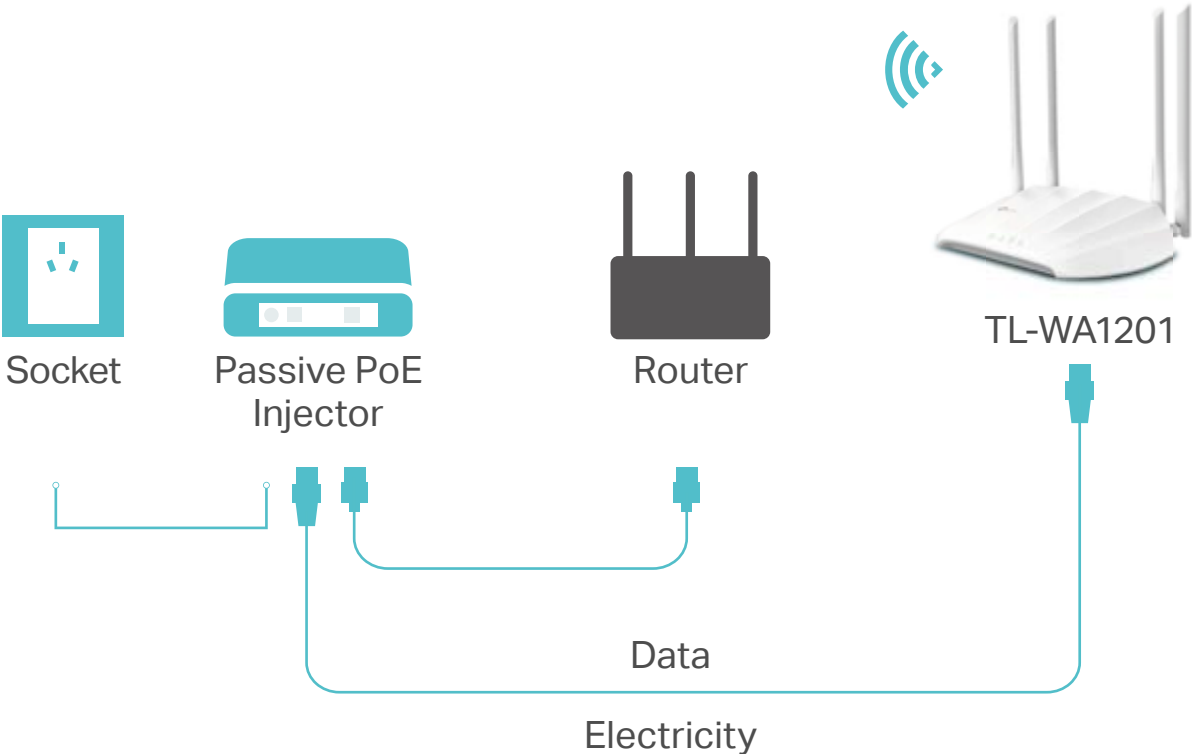

Vast Wi-Fi Coverage

Beamforming technology concentrates Wi-Fi towards devices to create stronger connections. Four external antennas deliver Wi-Fi to every corner of your home†.

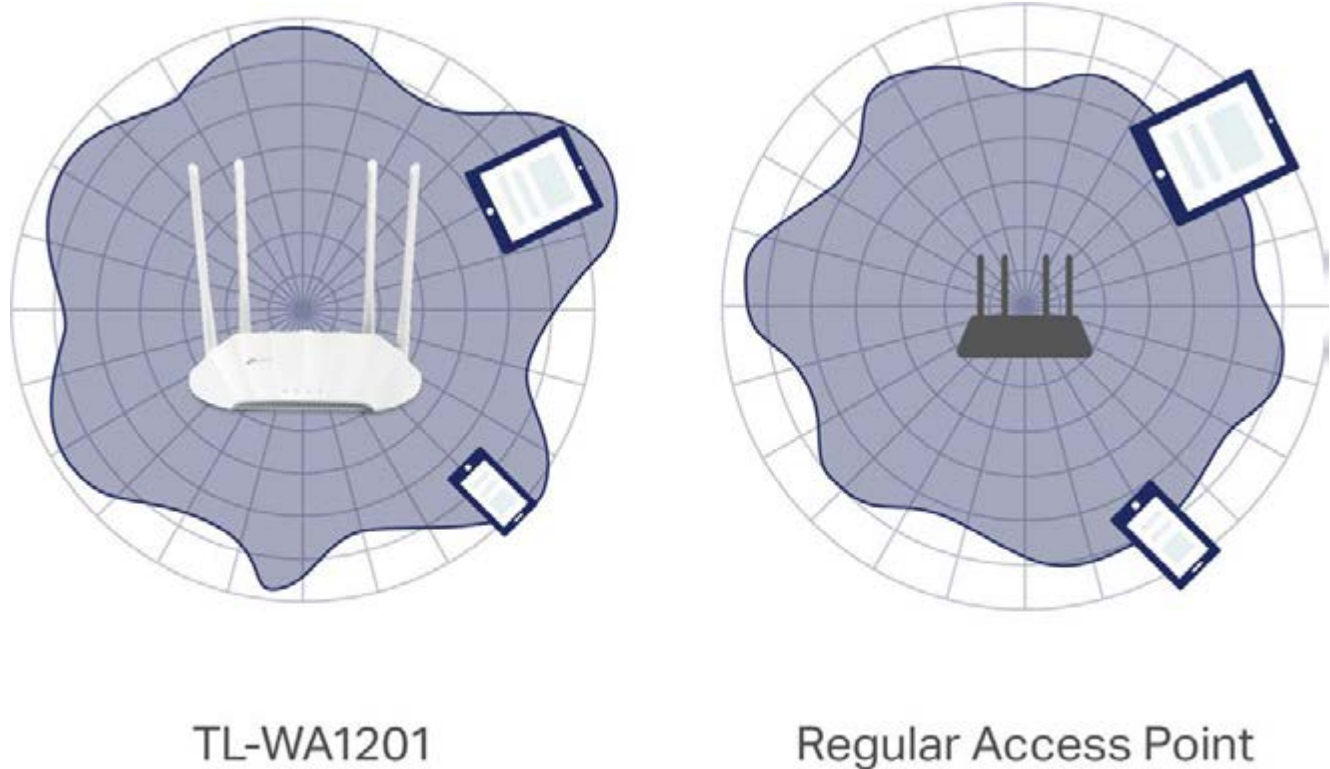

TP-Link AC1200 Wireless Access Point TL-WA1201

Features



Speed

- MU-MIMO – Simultaneously transfers data to multiple devices for 2× faster performance[†]
- Ultimate Wireless Speed – 300 Mbps on 2.4 GHz + 867 Mbps on 5 GHz
- Gigabit Ethernet Port – Make full use of the gigabit broadband speed

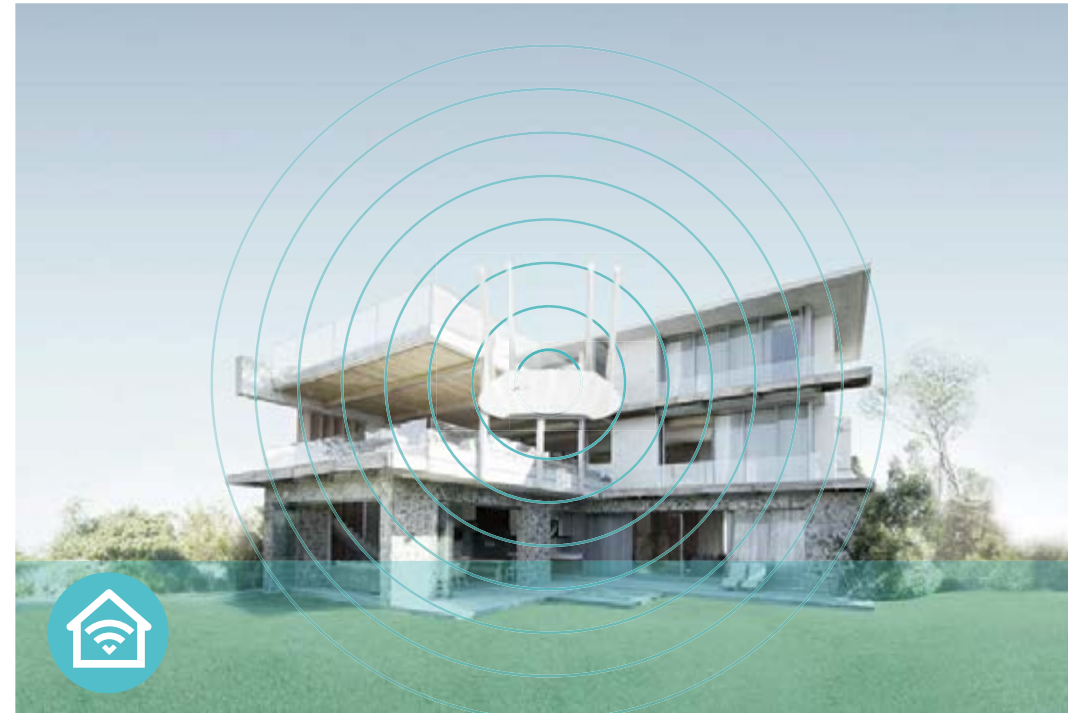

Wi-Fi Range

- Ultimate Range Wi-Fi – Four high-gain external antennas deliver a Wi-Fi signal to every corner of your home, making all of your connections more efficient and stable
- Beamforming Technology – Sends targeted Wi-Fi signal to individual devices for stronger connections



Ease of Use

- Multi-Mode – Supports Access Point, Client, Range Extender and Multi-SSID (VLAN Support) modes to meet any network need
- Intuitive Web UI – Ensures quick and simple installation without hassle
- WPS – Makes secure wireless connection quick and easy with the push of a WPS button
- Quick Wi-Fi Sharing – Generates a QR code from Web UI to quickly share Wi-Fi with your guests

TP-Link AC1200 Wireless Access Point TL-WA1201

Specifications

Hardware

- Ethernet Port: 1 10/100/1000 Mbps Ethernet Port (Supports Passive PoE)
- Buttons: Power On/Off Button, WPS Button, Reset Button
- Antennas: 4 Fixed High Performance Antennas
- External Power Supply: 12V/1.5A
- Dimensions (W x D x H): 8.9x5.7x1.5 in (225x145.5x37mm)

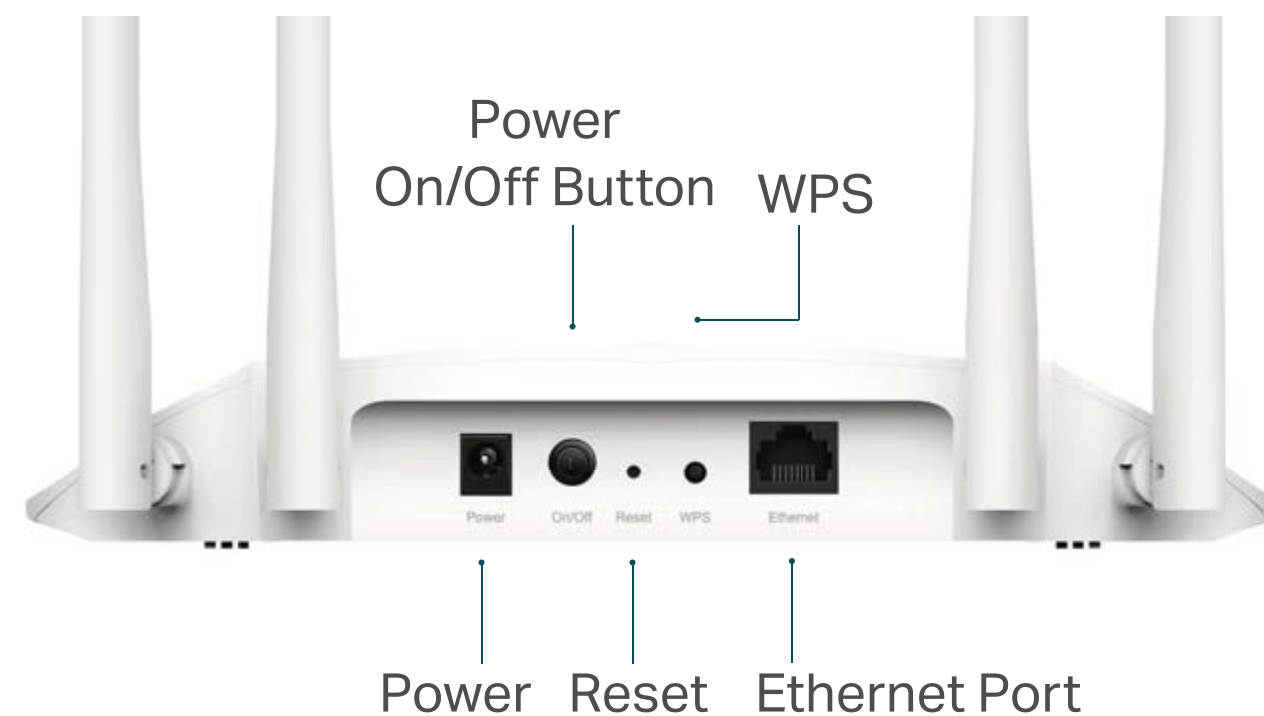

Wireless

- Wireless: IEEE802.11b/g/n 2.4 GHz, IEEE 802.11ac/n/a 5 GHz
- Frequency: 2.4 GHz and 5 GHz
- Signal Rate: 867 Mbps at 5 GHz, 300 Mbps at 2.4 GHz
- Transmit Power:
CE: <20dBm(2.4GHz), <23dBm(5.15GHz~5.25GHz)
FCC: <30dBm(2.4GHz&5GHz)
- Reception Sensitivity:
5 GHz:
11a 6 Mbps: -95 dBm, 11a 54 Mbps: -81 dBm
11ac VHT20(MCS0): -94 dBm, 11ac VHT20(MCS8): -71 dBm
11n HT40(MCS0): -91 dBm, 11n HT40(MCS7): -71 dBm
11ac VHT80(MCS0): -88 dBm, 11ac VHT80(MCS9): -63 dBm
2.4 GHz:
11g 54Mbps: -78 dBm
11n HT20(MCS0): -92 dBm, 11n HT20(MCS7): -74 dBm
11n HT40(MCS0): -88 dBm, 11n HT40(MCS7): -72 dBm
- Wireless Function:
Enable/Disable Wireless Radio, WDS Bridge, WMM, Wireless Statistics, Wireless Multicast Forwarding, DHCP Server, Access Control
- Wireless Security:
64/128-bit WEP, WPA/WPA2, WPA-PSK/WPA2-PSK encryptions

TP-Link AC1200 Wireless Access Point TL-WA1201

Specifications

Software

- Quality of Service: WMM
- DHCP: Server, DHCP Client List
- Wireless Modes: Access Point, Repeater, Client, Multi-SSID
- Protocols: IPv4, IPv6
- System Tools: SNMP, Ping Watch Dog



For more information, please visit

<https://www.tp-link.com/products/details/?model=TL-WA1201>

or scan the QR code left

Attention: This device may only be used indoors in all EU member states and EFTA countries.

Specifications are subject to change without notice. TP-Link is a registered trademark of TP-Link International Limited. Other brands and product names are trademarks or registered trademarks of their respective holders. Copyright ©2019 TP-Link International Limited. All rights reserved.

This device complies with part 15 of the FCC Rules. Operation is subject to the following two conditions: (1) This device may not cause harmful interference, and (2) this device must accept any interference received, including interference that may cause undesired operation.

*Maximum wireless signal rates are the physical rates derived from IEEE Standard 802.11 specifications. Actual wireless data throughput and wireless coverage are not guaranteed and will vary as a result of network conditions, client limitations, and environmental factors, including building materials, obstacles, volume and density of traffic, and client location.

*Use of MU-MIMO requires clients to also support MU-MIMO.

Others

- Certification:
CE, FCC, RoHS
- System Requirements:
Microsoft Windows 98SE, NT, 2000, XP, Vista™ or Windows 7, 8, 8.1, 10, MAC OS, NetWare, UNIX or Linux
Internet Explorer 11, Firefox 12.0, Chrome 20.0, Safari 4.0, or other Java-enabled browser
- Environment:
Operating Temperature: 0°C ~ 40°C(32°F ~ 104°F)
Storage Temperature: -40°C ~ 70°C (-40°F ~ 158°F)
Operating Humidity: 10%~90% non-condensing
Storage Humidity: 5%~90% non-condensing
- Package Contents
Wireless Access Point TL-WA1201
Power Adapter
RJ45 Ethernet Cable
Quick Installation Guide
PoE Power Injector

www.tp-link.com

TP-Link AC1200 Wireless Access Point TL-WA1201