

# Quick Installation Guide V1.0.0

## NOTE

- Please make sure the mounting surface is strong enough to hold at least three times of the camera weight.
- For wooden mounting surface, expansion bolts are optional.

### Model A

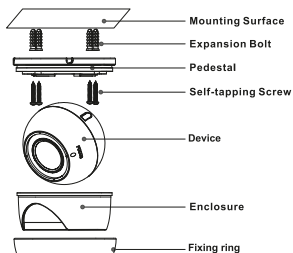
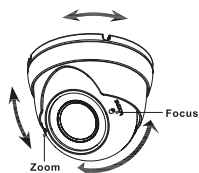

## NOTE

You can adjust zoom and focus with a screwdriver.

### Model B

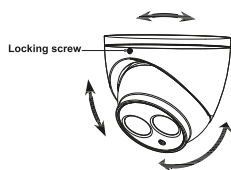

### Model C

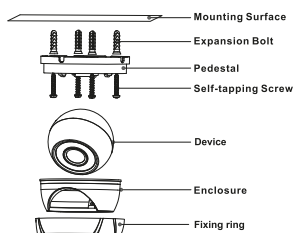
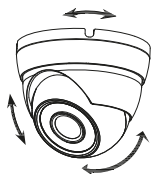

### Model D

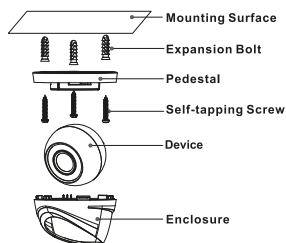
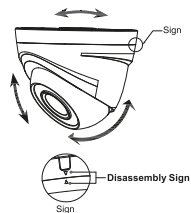

1.2.51.32.14512-000

### Model E

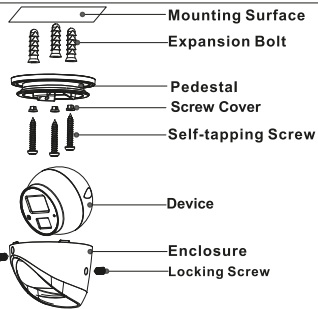
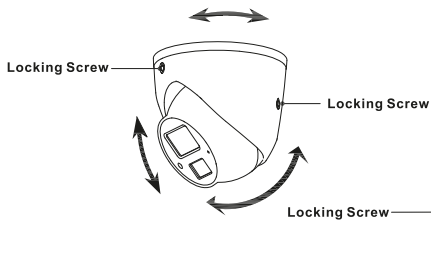

### Model F

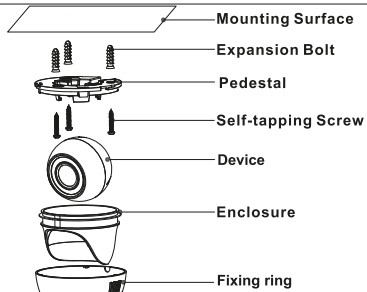
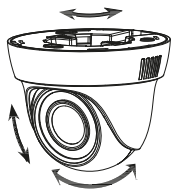

### Model G

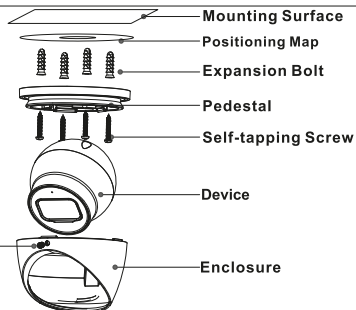
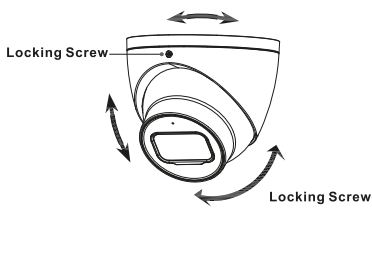

### Model H

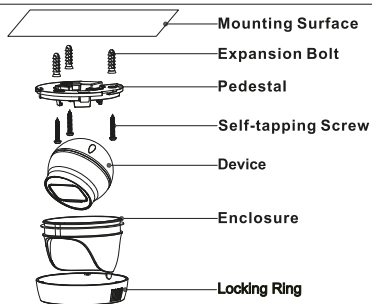
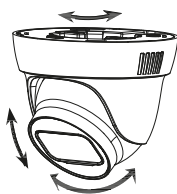

#### NOTE

This manual is for reference only. Please visit our website or contact your local service engineer for more information.