

**LEGO**

**duplo**

2



**10952**

LEGO.com/DUPLO

**TM.by**  
ONLINE STORE

<https://tm.by>  
Интернет-магазин





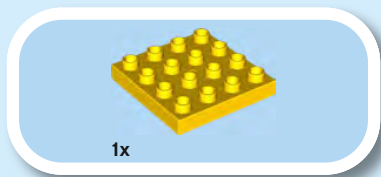

1

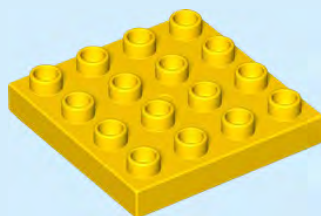

4

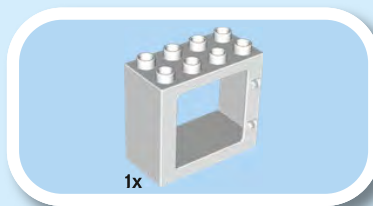

2



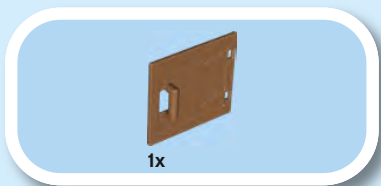

3

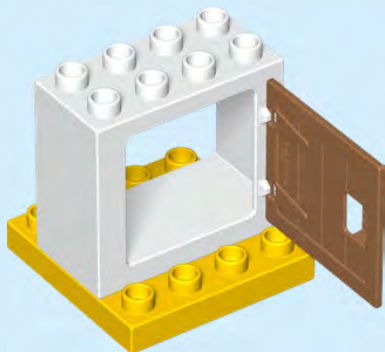

4



5



5

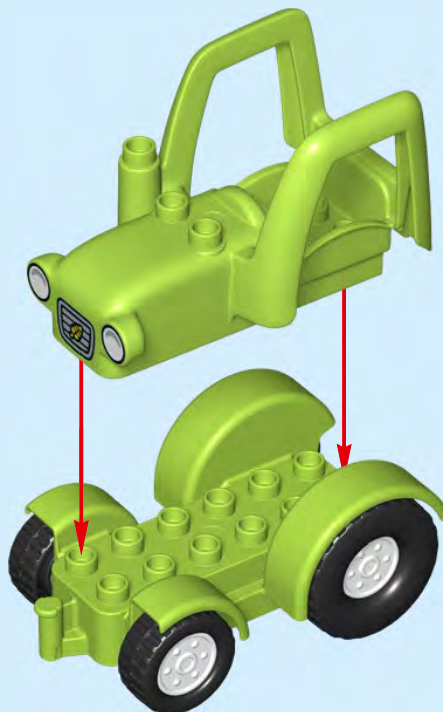

6



6



7







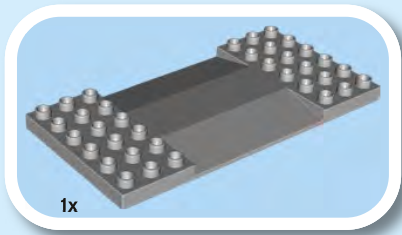

1

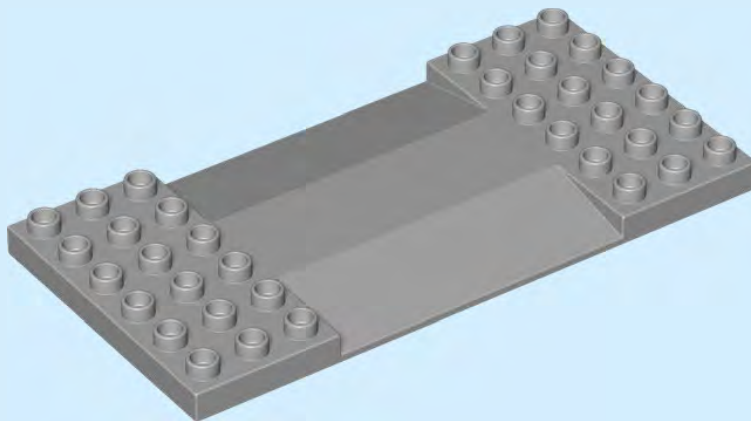

10

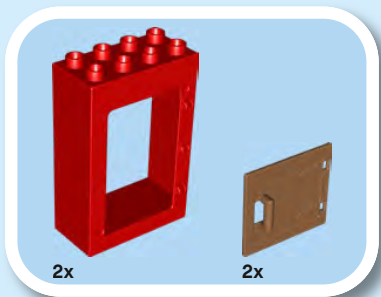

2

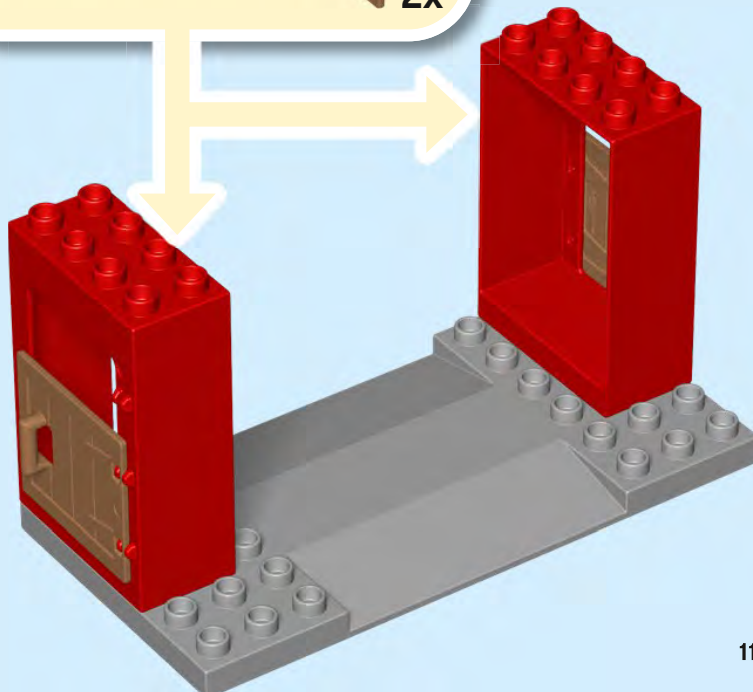
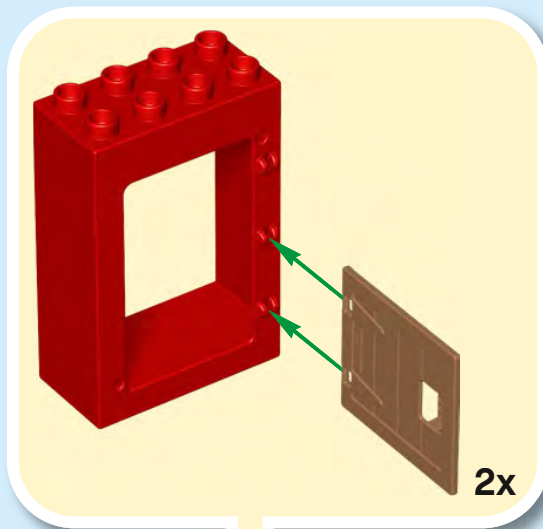

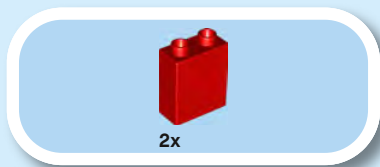

3

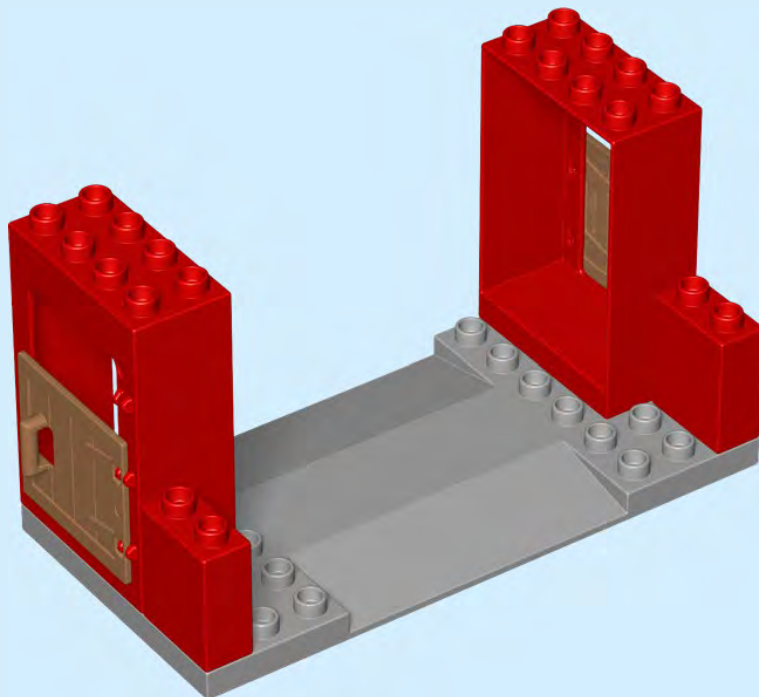

12

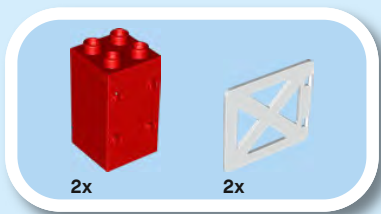

4

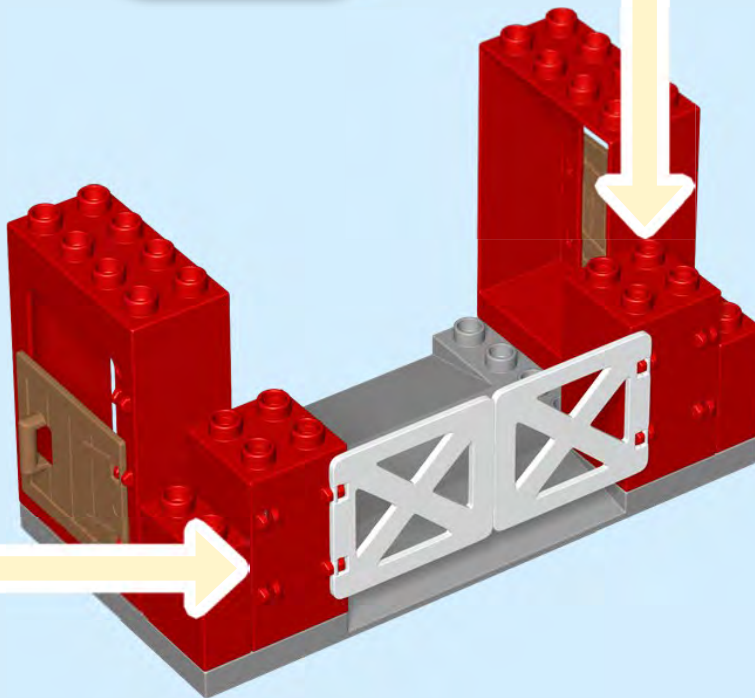
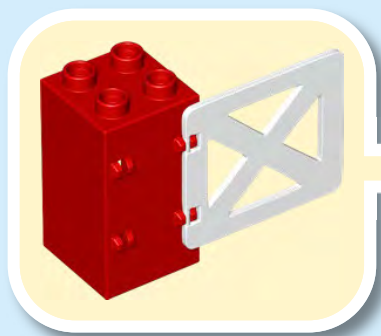
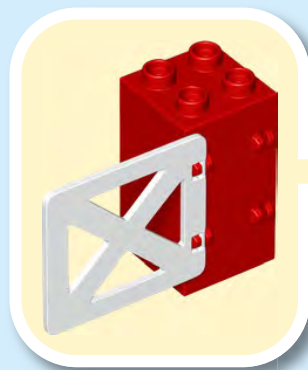

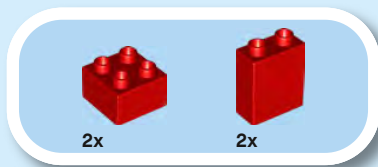

5

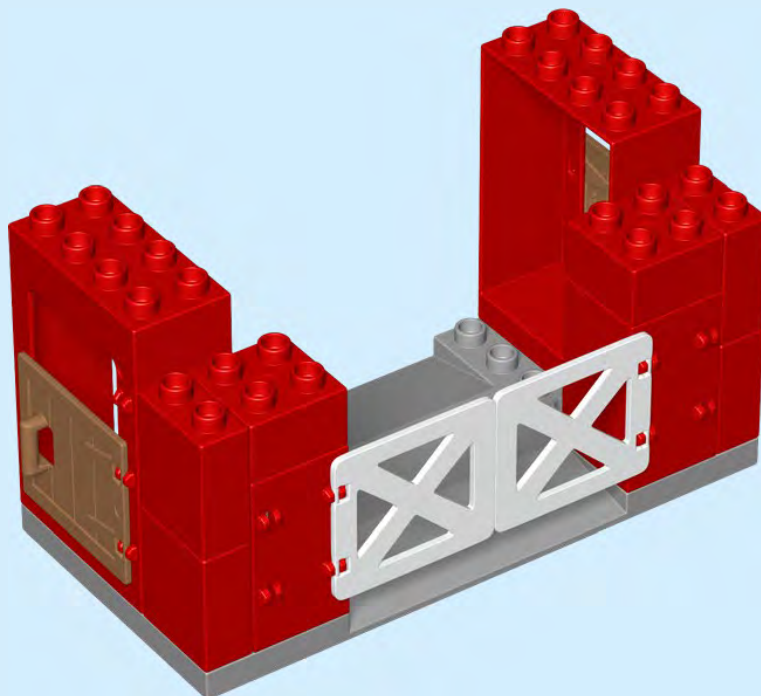

14

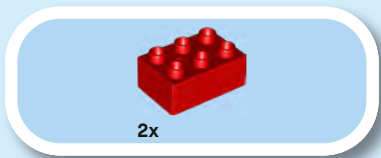

6

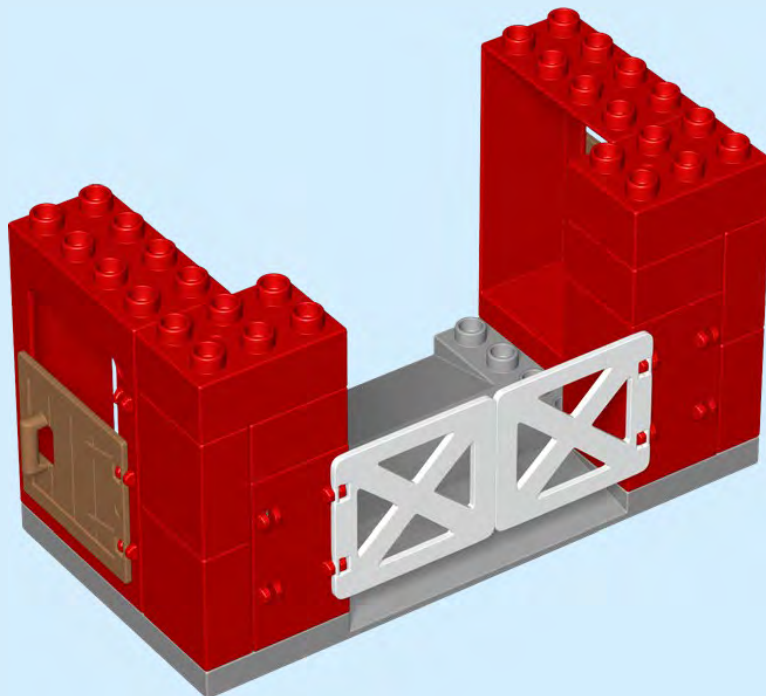

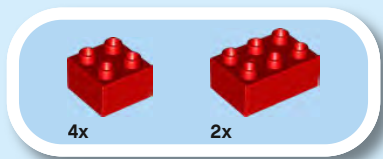

7

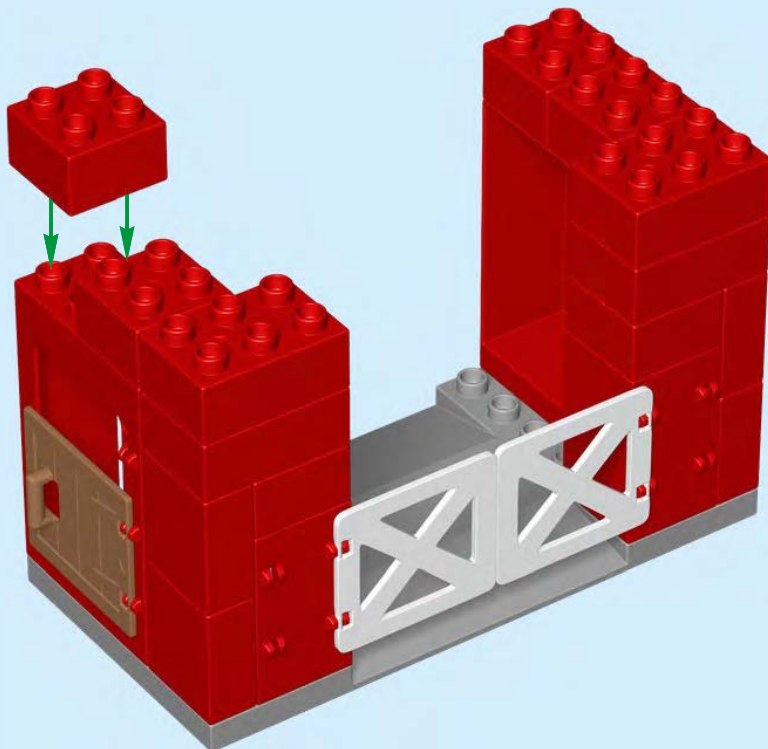

16



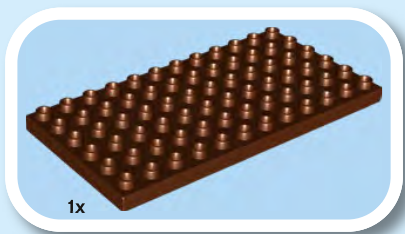

8

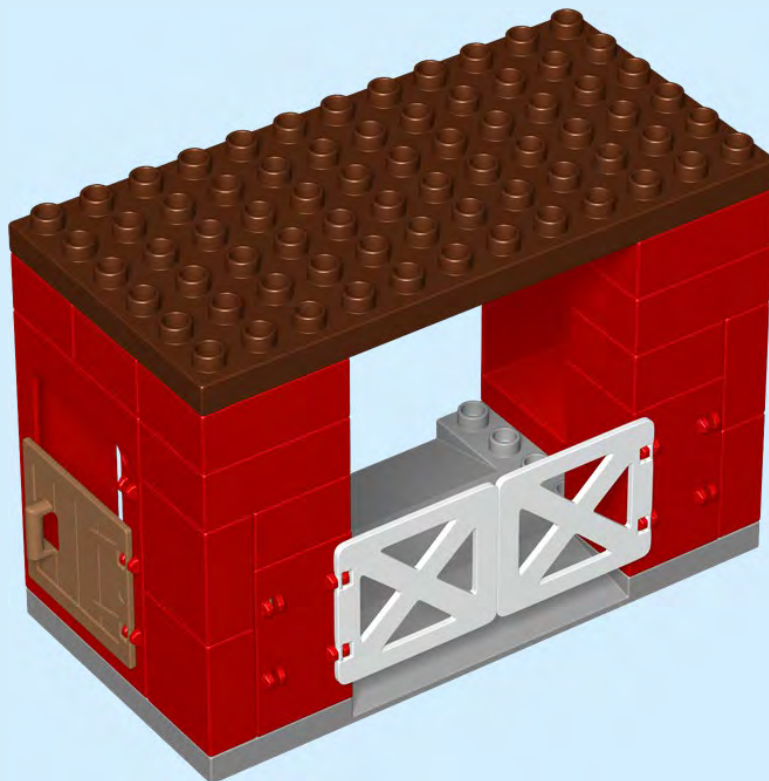

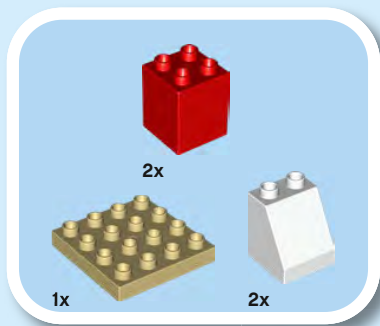

9

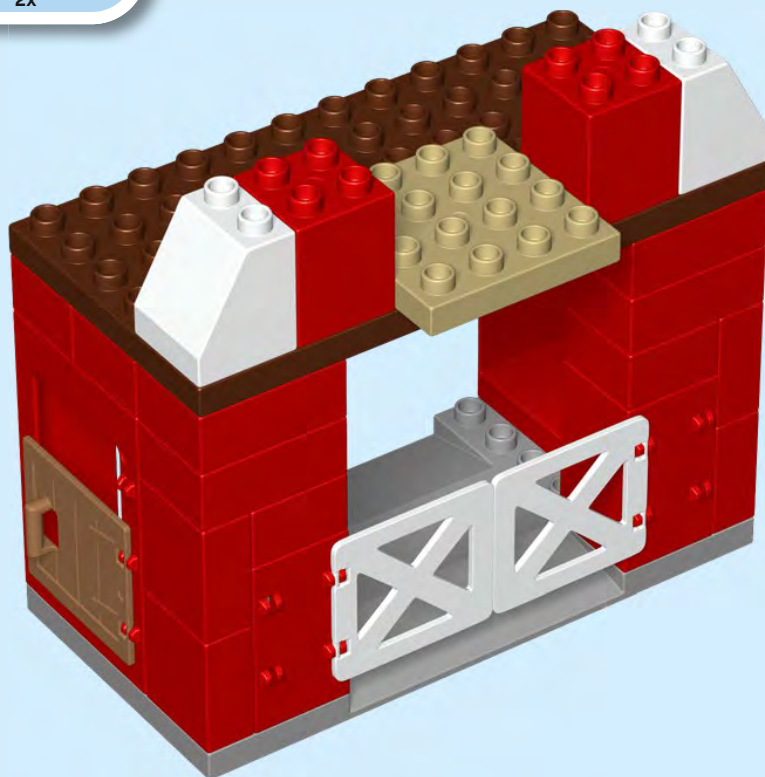

18

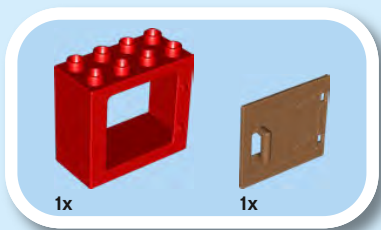

10

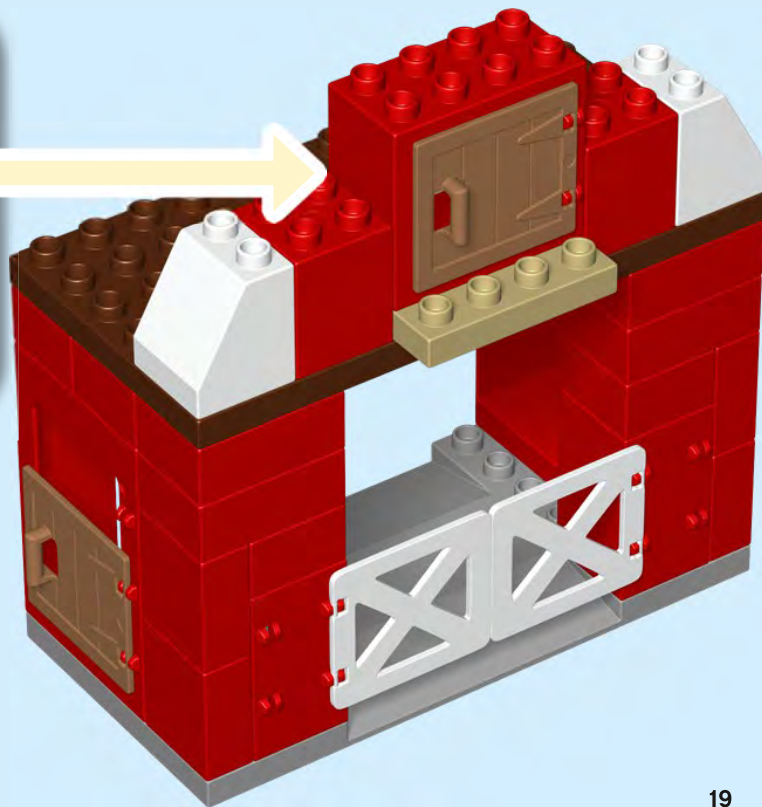
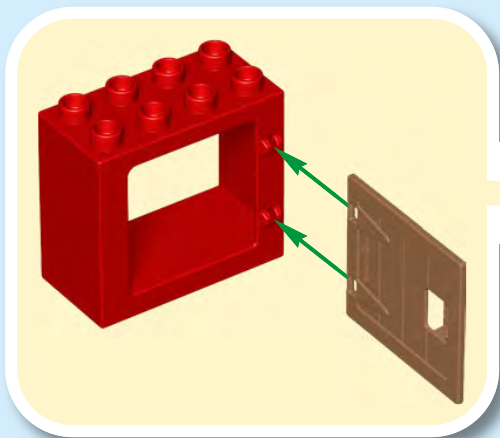

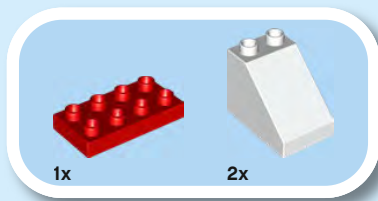

11

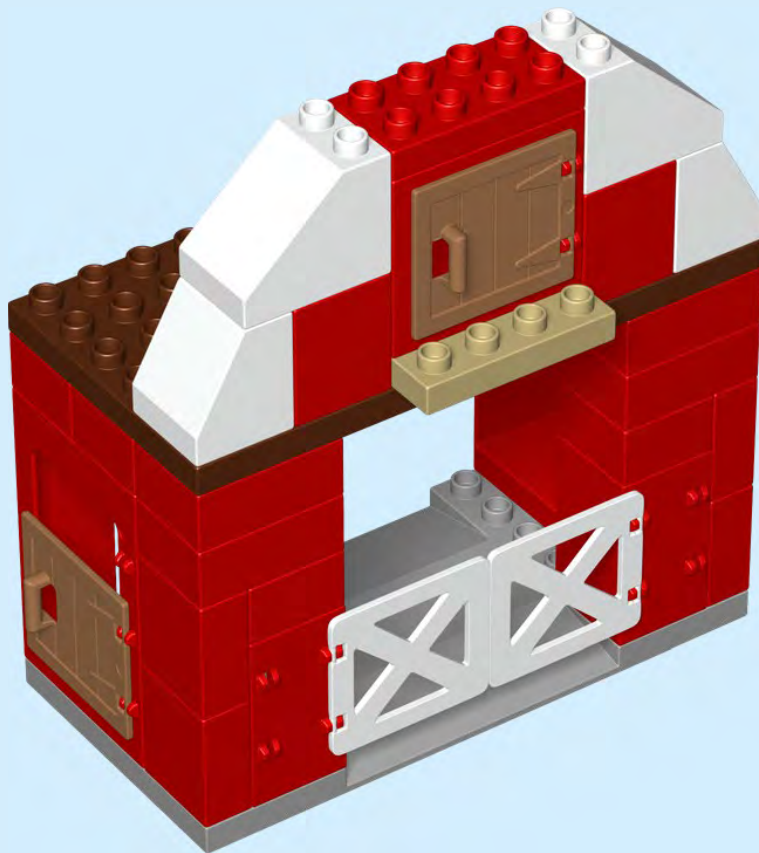

20

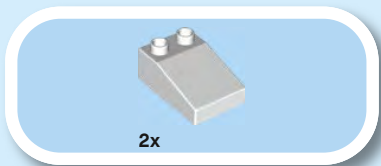

12

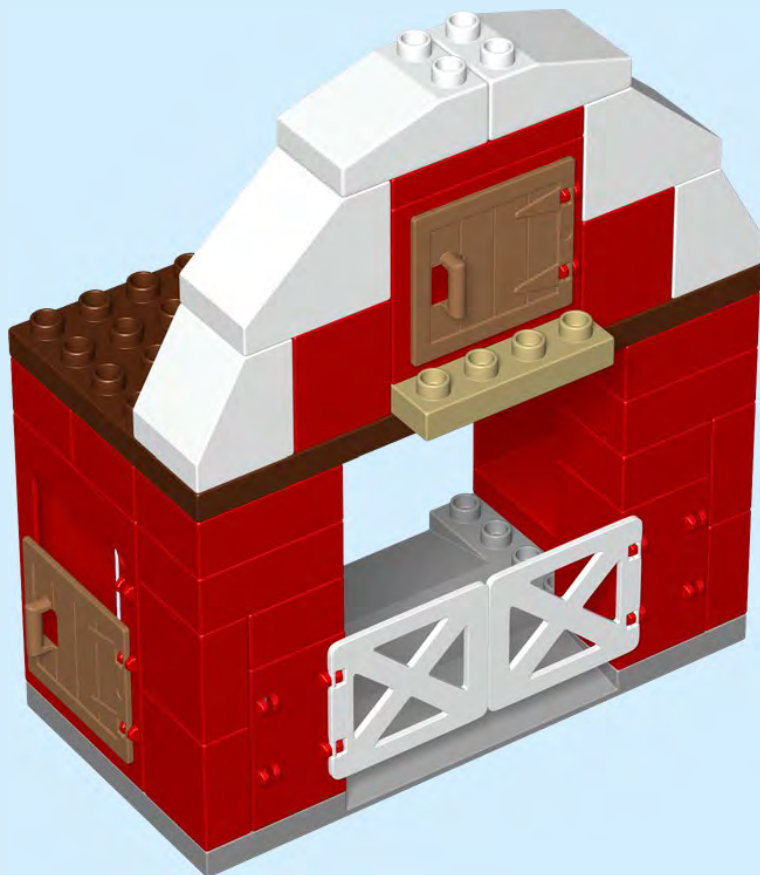

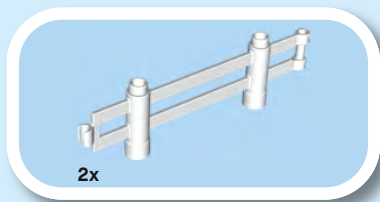

13

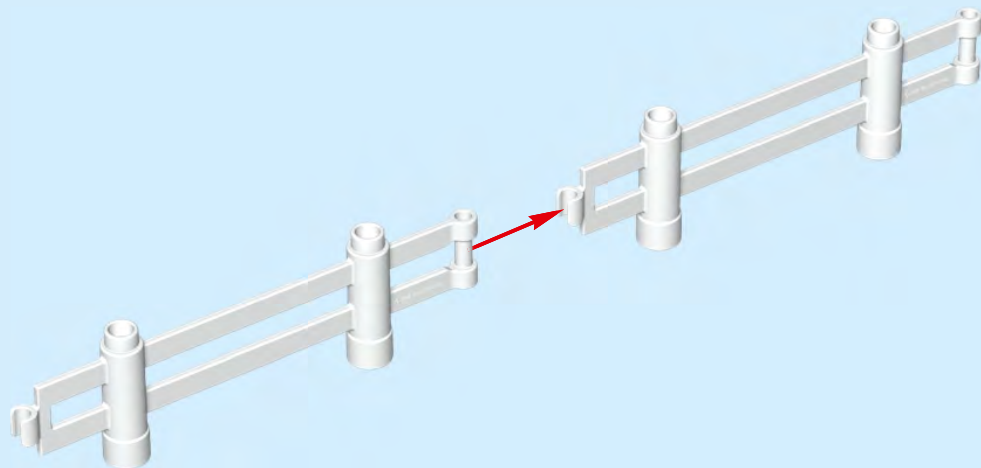

22



14

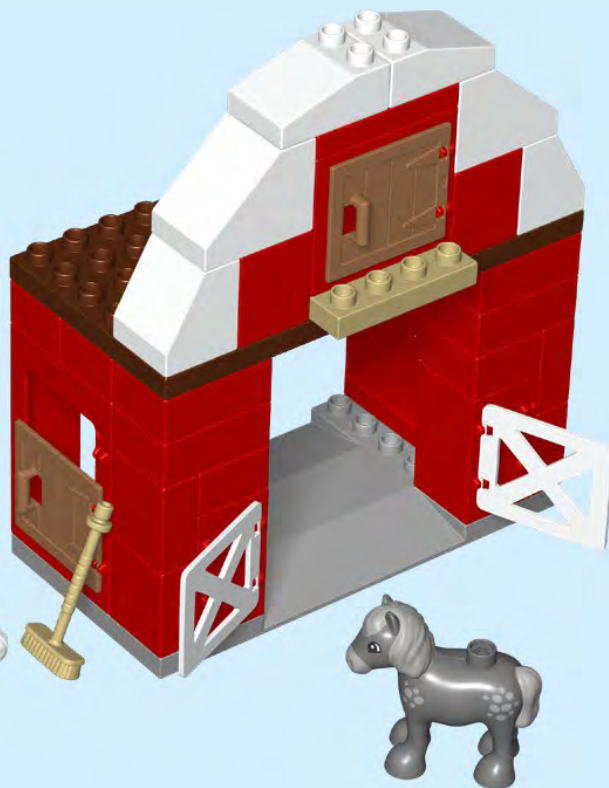

23

# EXPLORE THE DIGITAL UNIVERSE UN UNIVERS NUMÉRIQUE À EXPLORER EXPLORA EL UNIVERSO DIGITAL



COMPTINES  
DUPLO®

CANCIONES  
INFANTILES  
DUPLO®

LEGO, the LEGO logo, DUPLO and the DUPLO logo are trademarks of the/son/sont des marques de commerce de/son marcas registradas de LEGO Group.  
©2021 The LEGO Group. All rights reserved/Tous droits réservés/Todos los derechos reservados. 6362461



Customer Service  
Kundenservice  
Service Consommateurs  
Servicio Al Consumidor

LEGO.com/service or dial

 : 00800 5346 5555

 : 1-800-422-5346

TM.by  
ONLINE STORE

<https://tm.by>  
Интернет-магазин