



duplo



10944

LEGO.com/DUPLO

TM.by
ONLINE STORE

<https://tm.by>
Интернет-магазин



duplo

Ages/
edades

1½

Ages/
edades

2+



© 2021 MARVEL
© Disney



**CREATE A
STORY**

**CRÉER UNE
HISTOIRE**



**CREA UNA
HISTORIA**

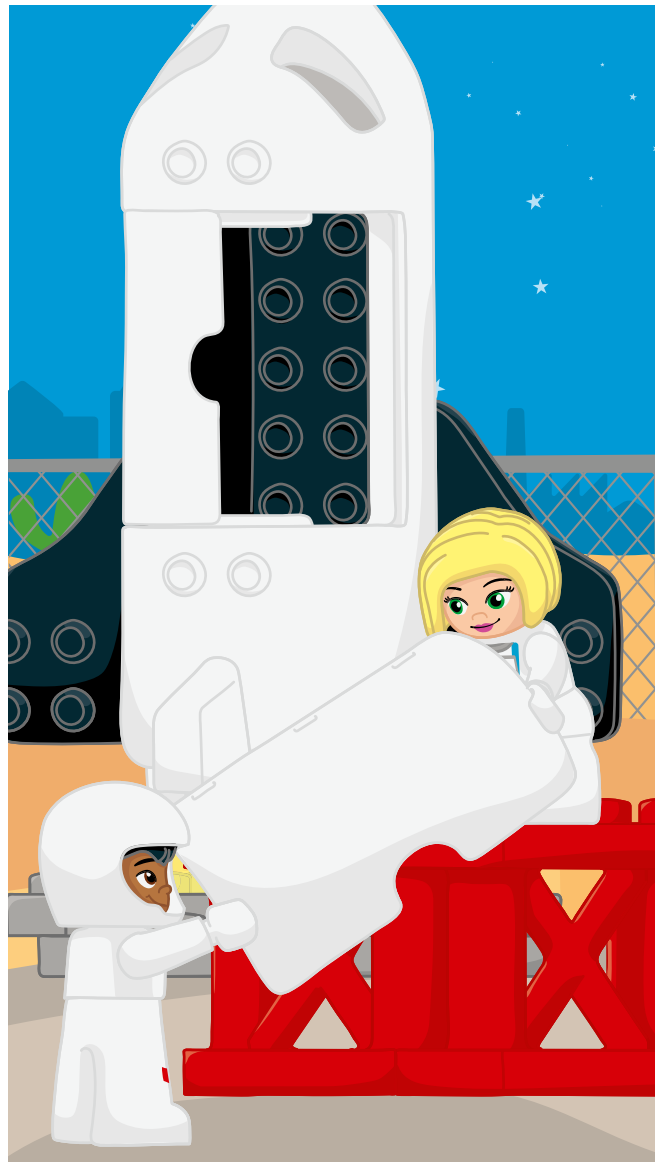
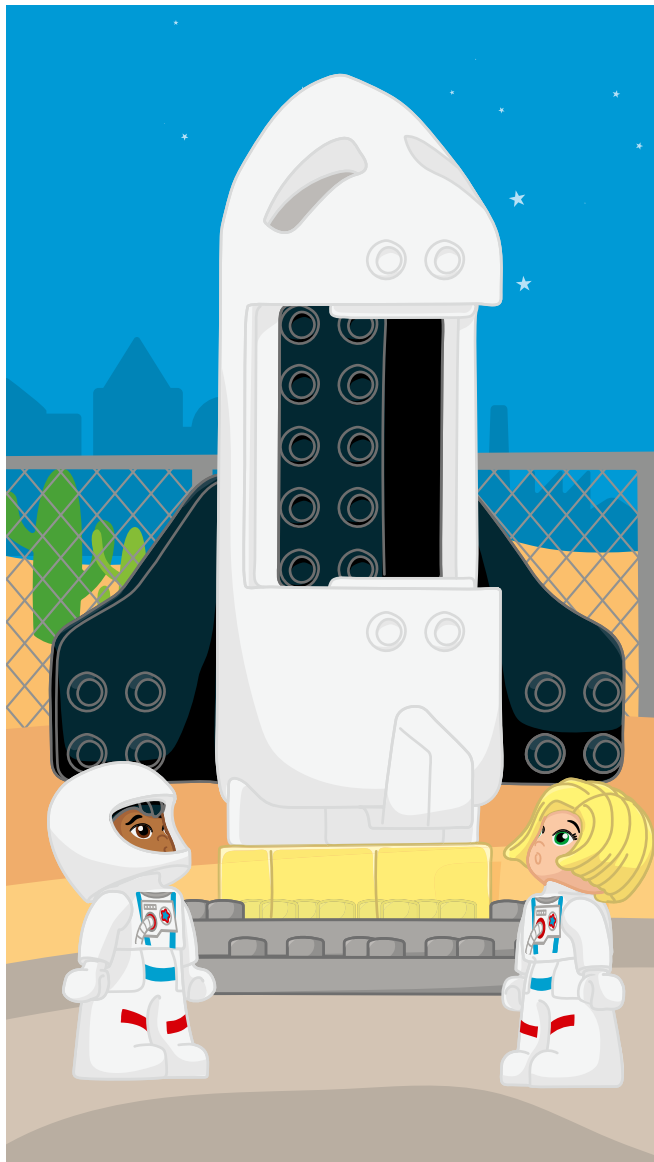

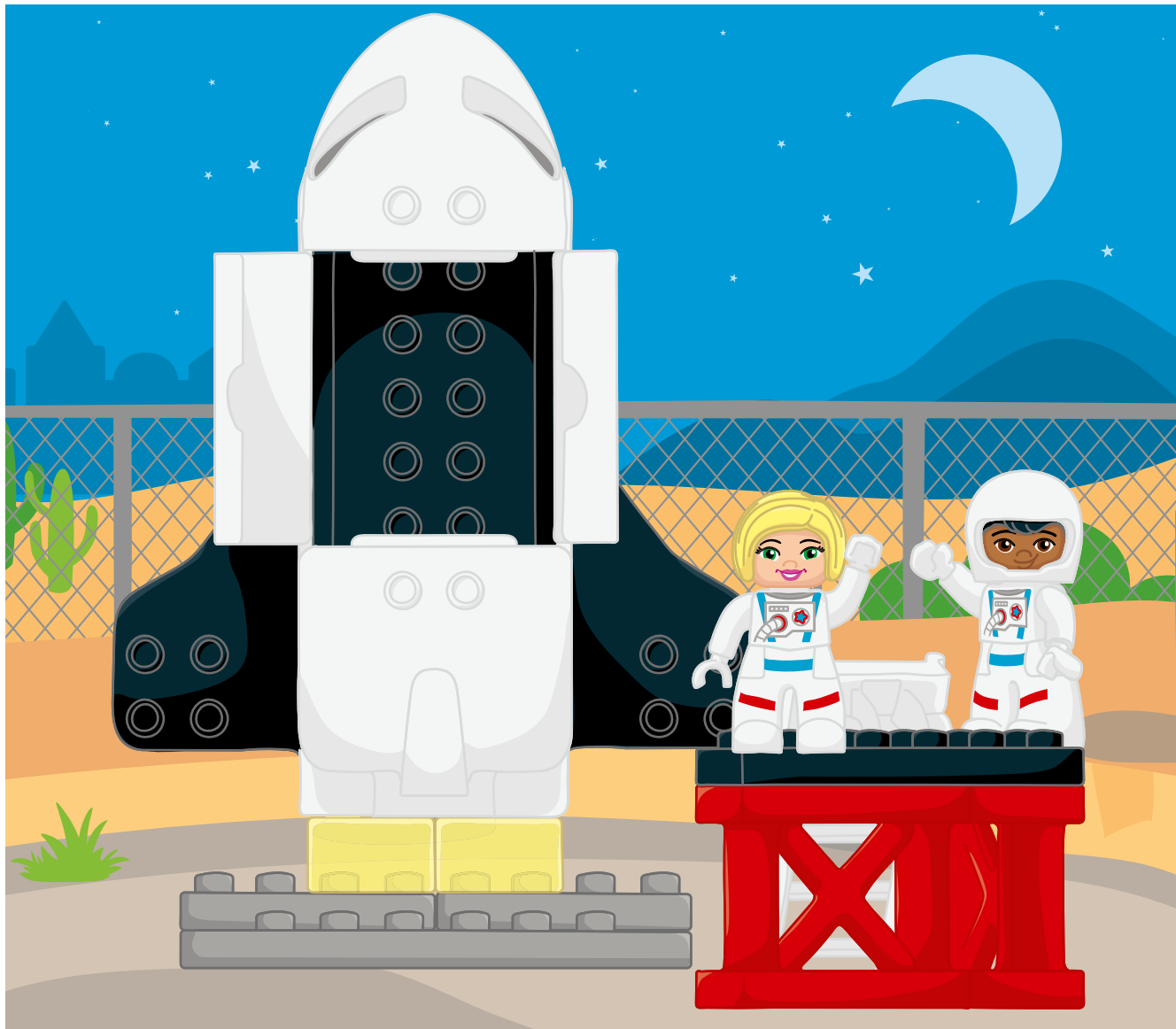



1



6

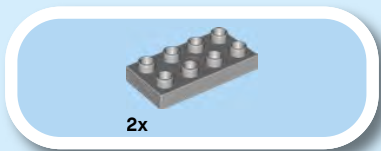

2

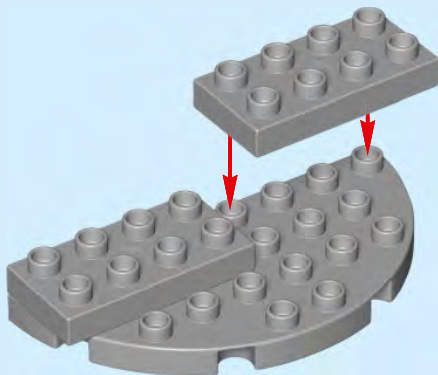

3

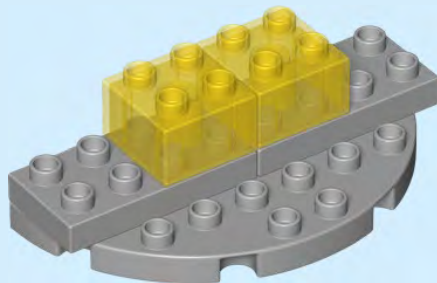



4

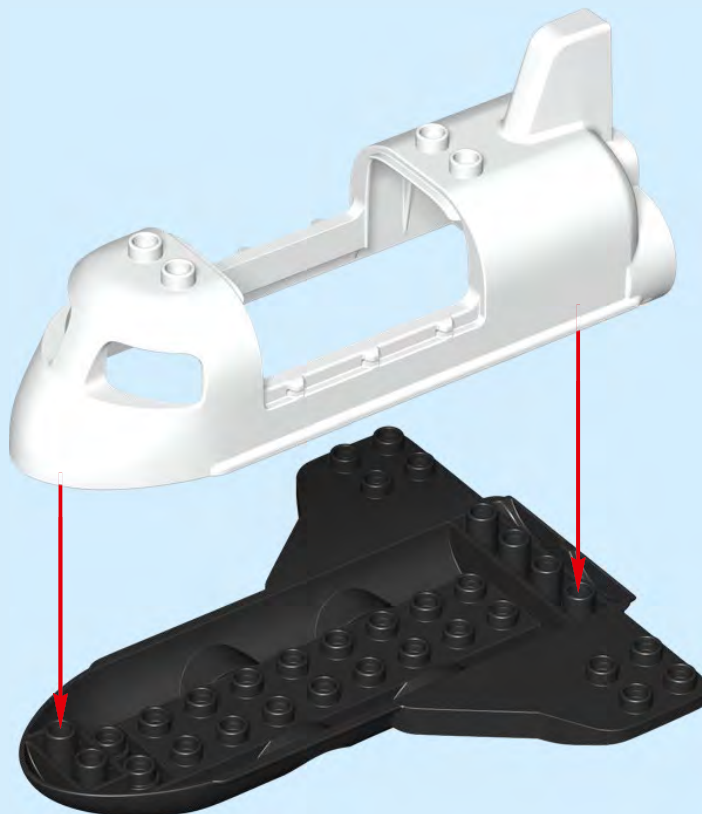

8



5

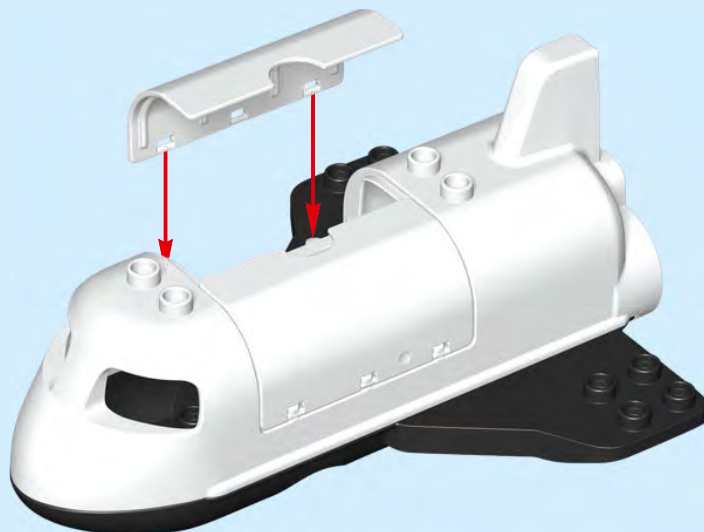

6

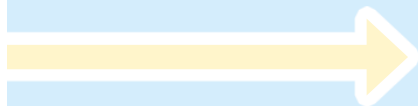

10

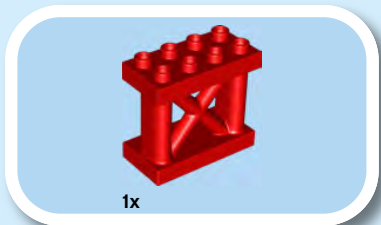

1x

7

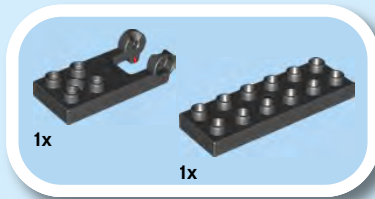
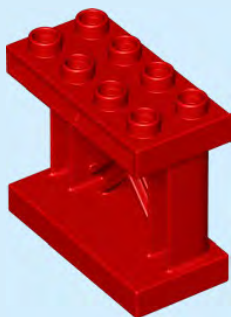

1x

1x

8



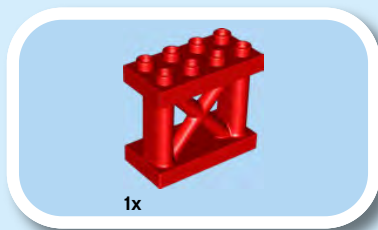

9



12

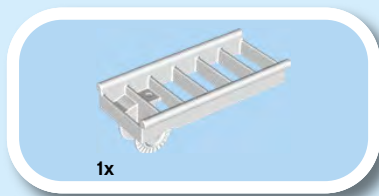

10

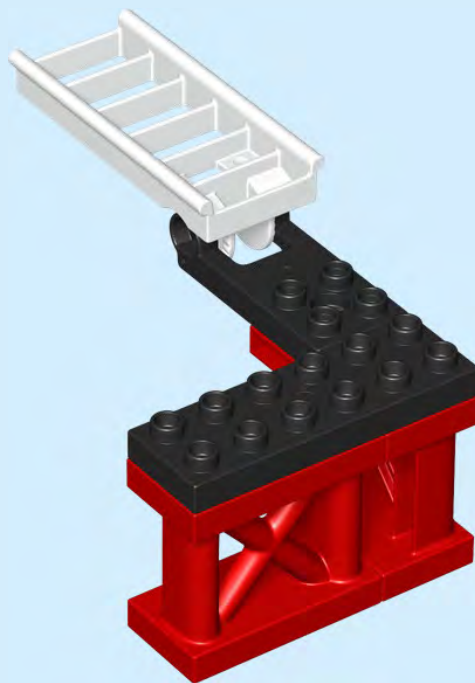

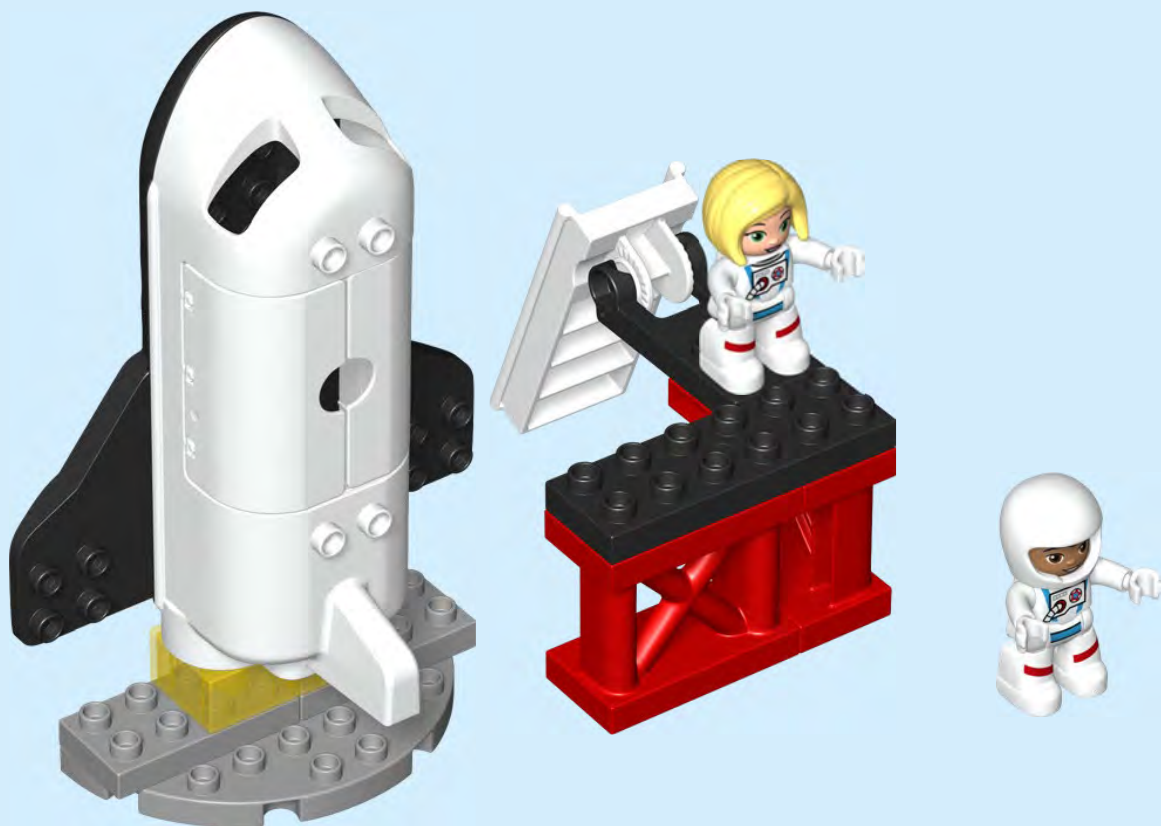

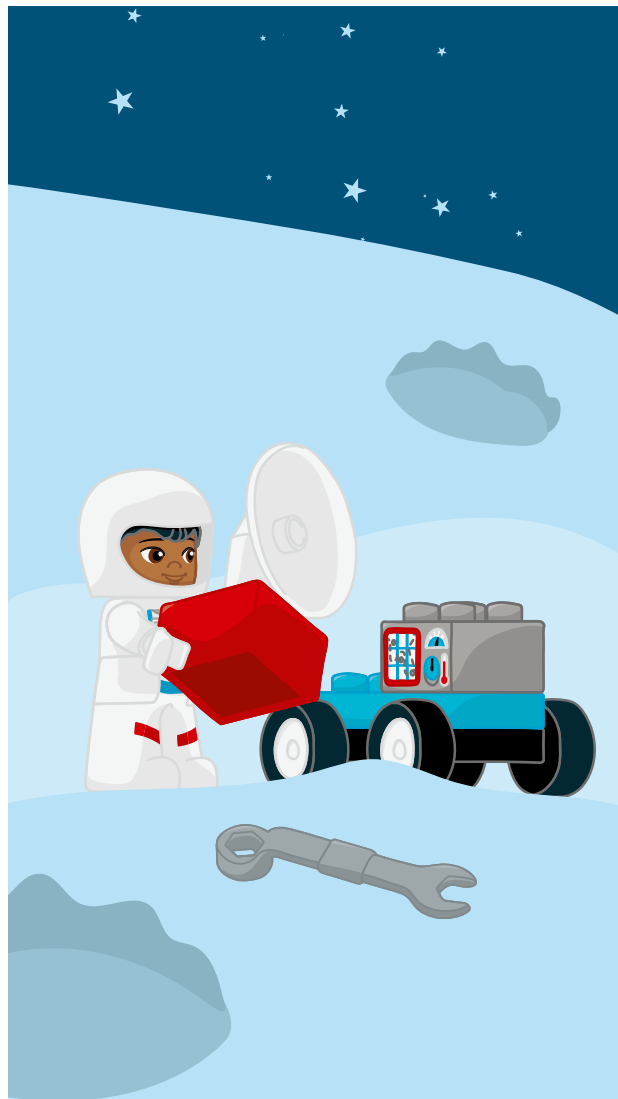
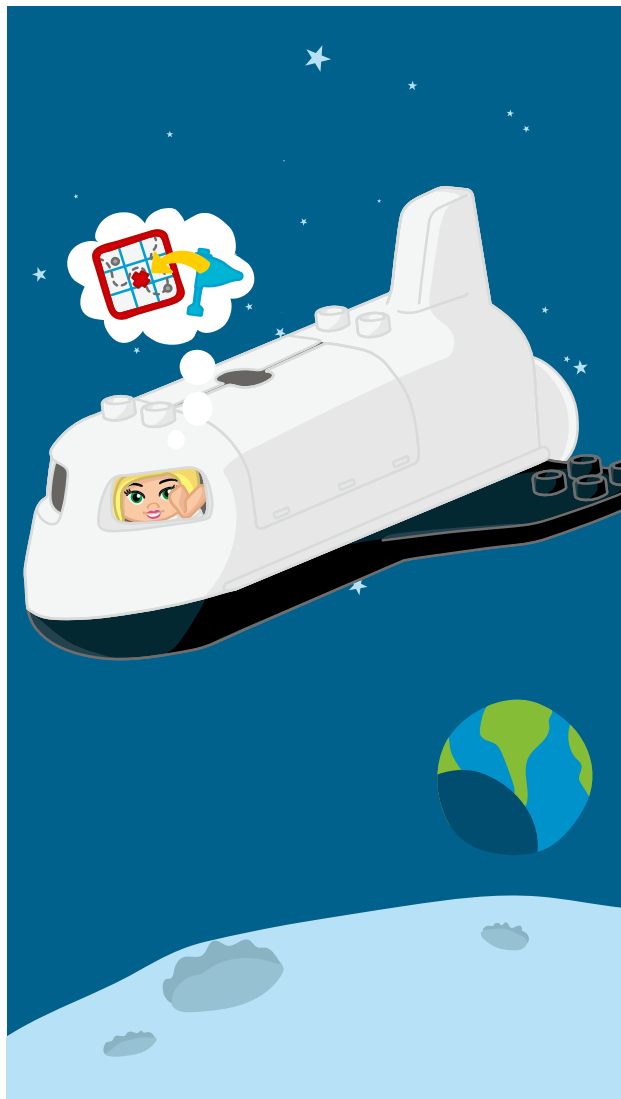

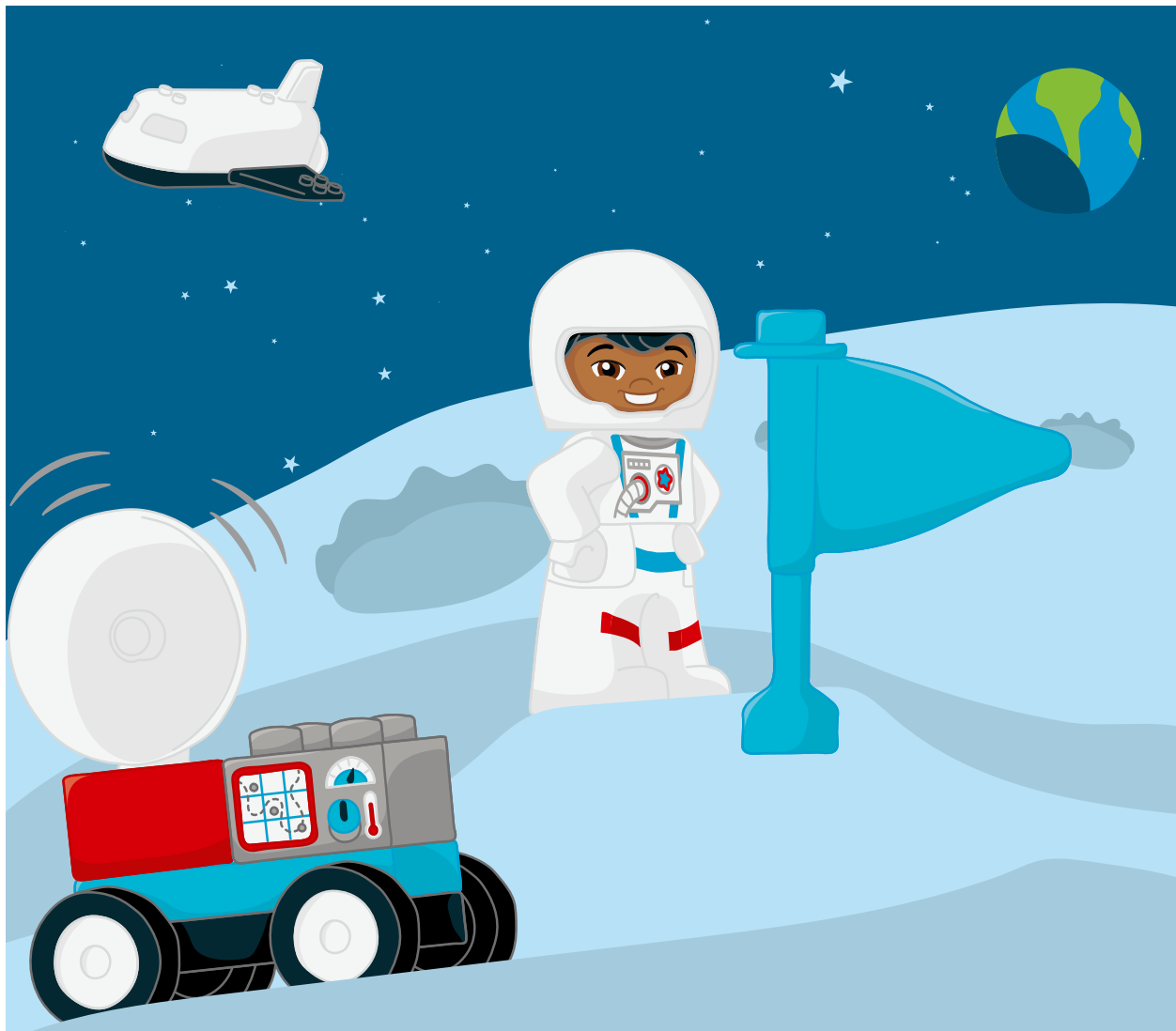

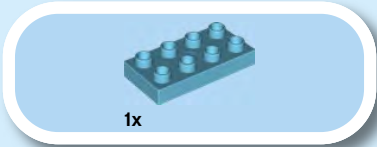

1x

1

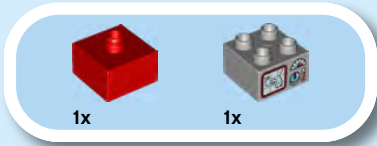

1x

1x

2



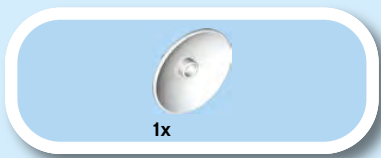

3



4



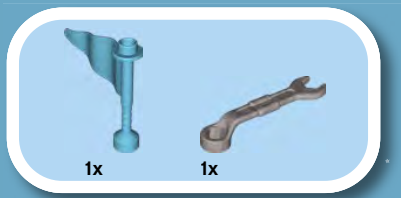

5

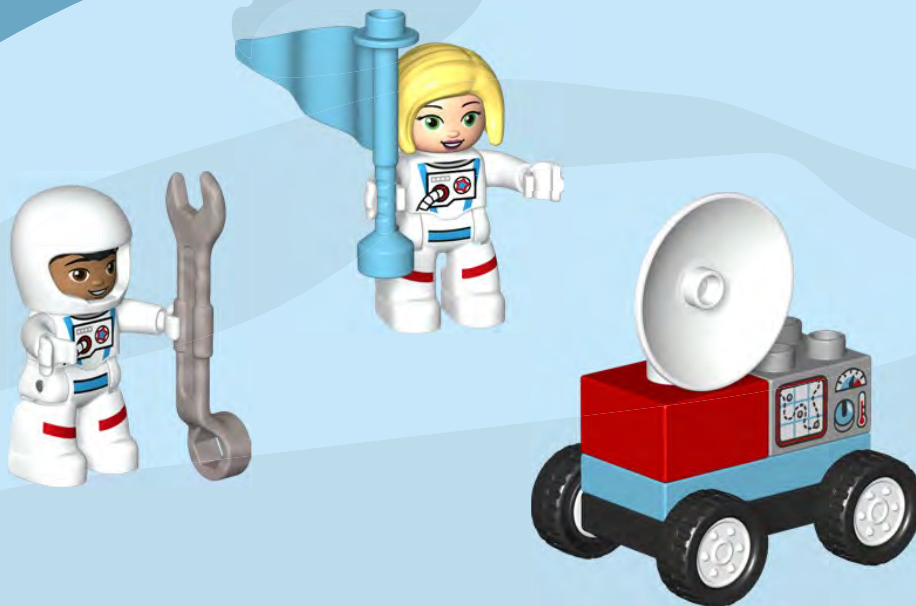

18

EXPLORE THE DIGITAL UNIVERSE UN UNIVERS NUMÉRIQUE À EXPLORER EXPLORA EL UNIVERSO DIGITAL



COMPTINES
DUPLO[®]

CANCIONES
INFANTILES
DUPLO[®]



Customer Service
Kundenservice
Service Consommateurs
Servicio Al Consumidor

LEGO.com/service or dial

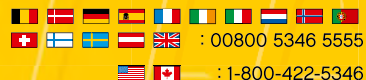
 : 00800 5346 5555
: 1-800-422-5346

TM.by
ONLINE STORE

<https://tm.by>
Интернет-магазин



Go to www.LEGO.com/productfeedback
 and give us your short
win
feedback about this
 LEGO® DUPLO® set for a chance to win
 a cool LEGO prize

Terms & Conditions apply

LEGO.com/productfeedback

GEWINNE

Erzähle uns auf
www.LEGO.com/productfeedback

etwas über die Erfahrungen, die du
 mit diesem LEGO® Set gemacht hast,
 und sichere dir die Chance auf einen
 coolen LEGO Preis!

Es gelten die Teilnahmebedingungen

GAGNE

Rends-toi sur
www.LEGO.com/productfeedback

et donne-nous quelques commen-
 taires sur ce produit LEGO® pour
 avoir une chance de gagner un
 prix LEGO !

Voir Conditions Générales

GANA

Visita
www.LEGO.com/productfeedback

y envíanos tu opinión acerca de este
 set LEGO®. ¡Participarás en el sorteo
 de un premio LEGO!

Términos y Condiciones aplicables

获取奖品

登录
www.LEGO.com/productfeedback

给出关于此乐高®套装的简短反
 馈，就有机会获得炫酷乐高奖品

《条款及条件》适用

LEGO, the LEGO logo, DUPLO and the DUPLO logo are trademarks of the/son des marques de commerce du/son marcas registradas de LEGO Group.
 ©2021 The LEGO Group. All rights reserved/Tous droits réservés/Todos los derechos reservados.

6365837