



# LEGO duplo



# 10951

LEGO.com/DUPLO

**TM.by**  
ONLINE STORE

<https://tm.by>  
Интернет-магазин



# duplo



Ages/  
edades

1½

Ages/  
edades

2+



© 2021 MARVEL  
© Disney

**TM.by**  
ONLINE STORE

<https://tm.by>  
Интернет-магазин



**CREATE A  
STORY**

**CRÉER UNE  
HISTOIRE**



**CREA UNA  
HISTORIA**

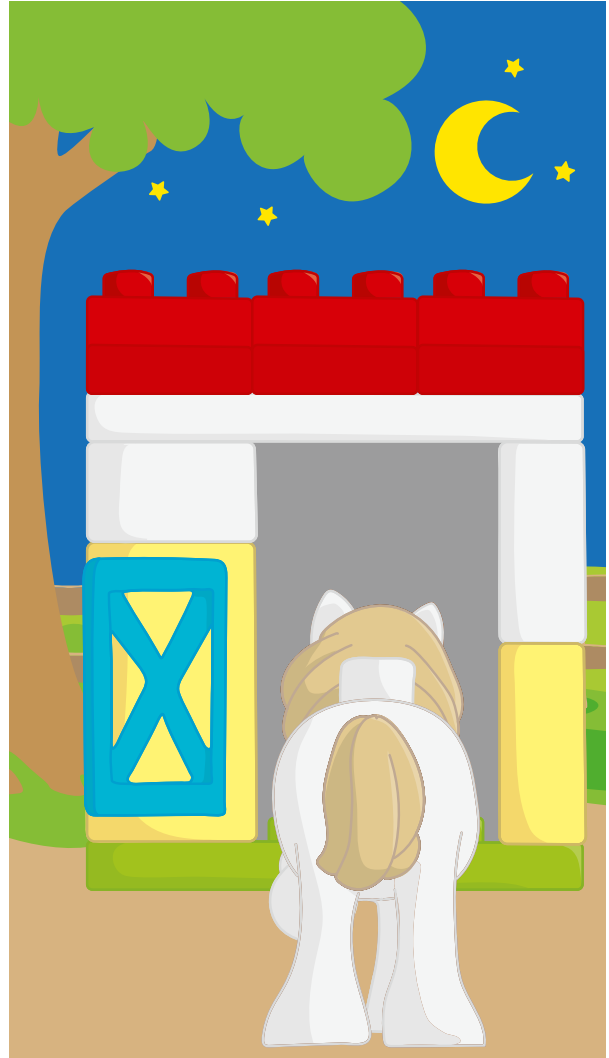



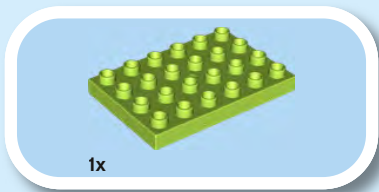
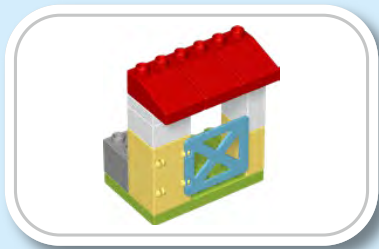

1x

1

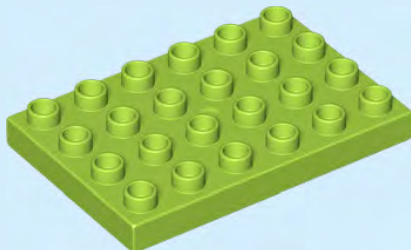

6

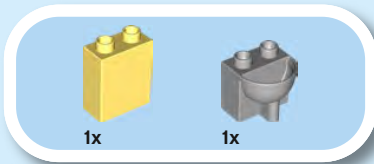

1x

1x

2

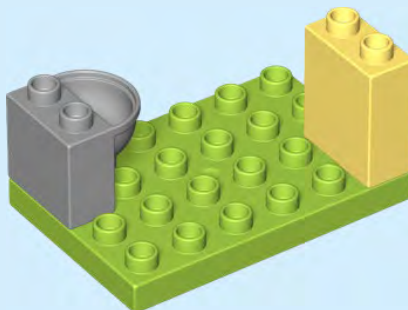



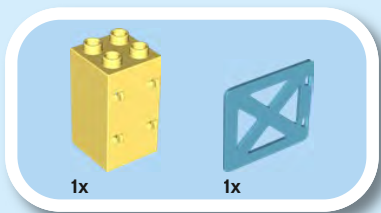

3

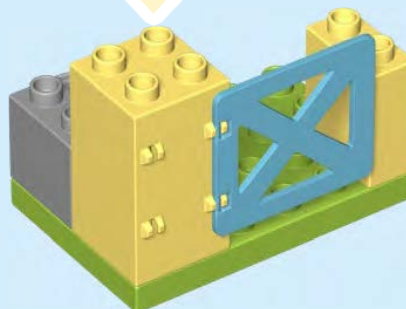
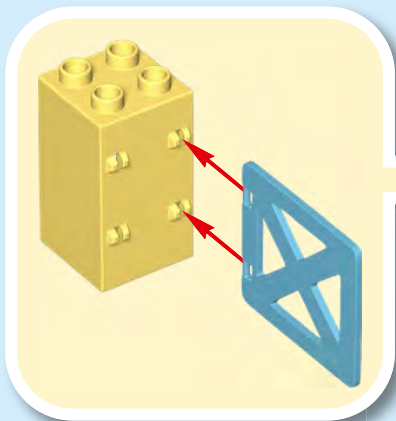

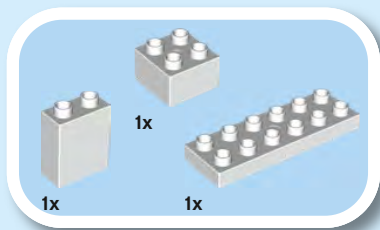

4

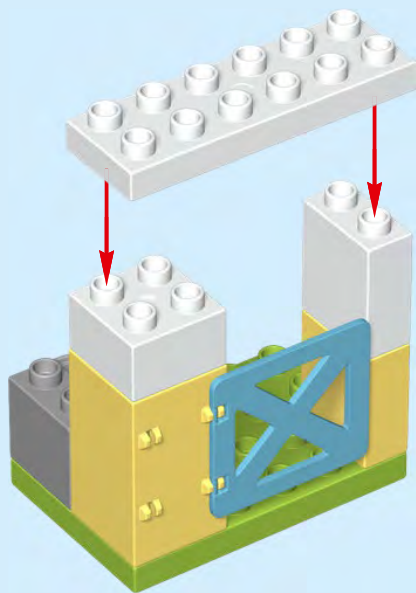

8



5

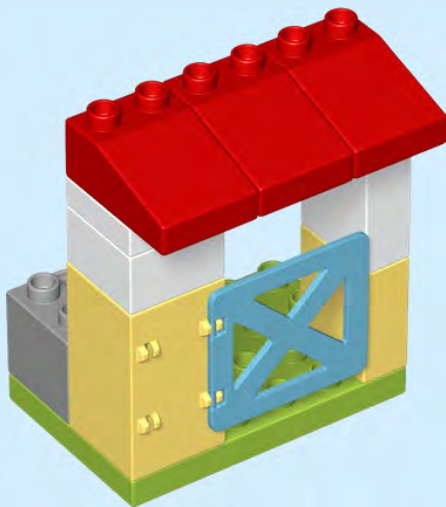





6



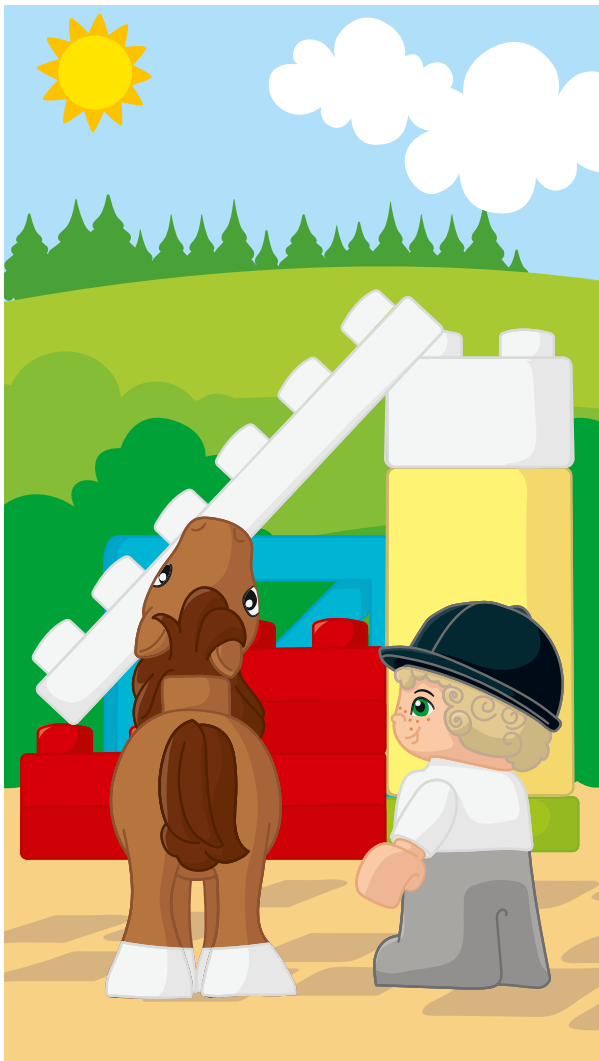



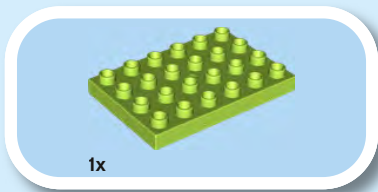

1x

1

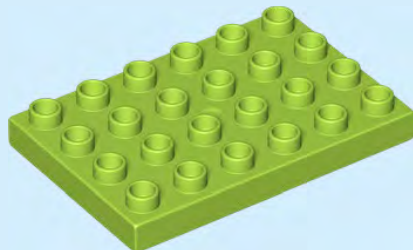

12

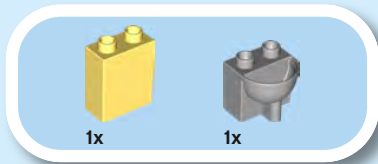

1x

1x

2

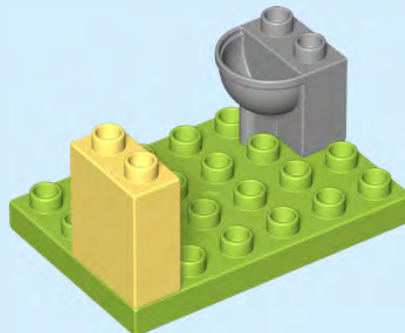

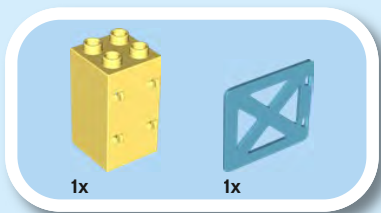

3

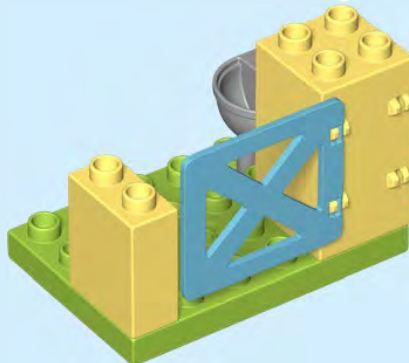
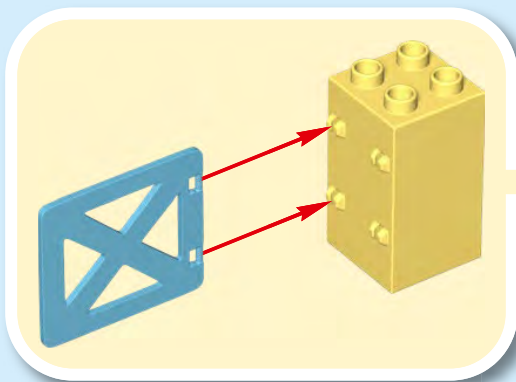

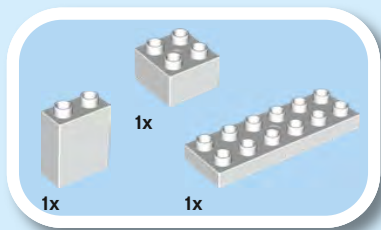

4

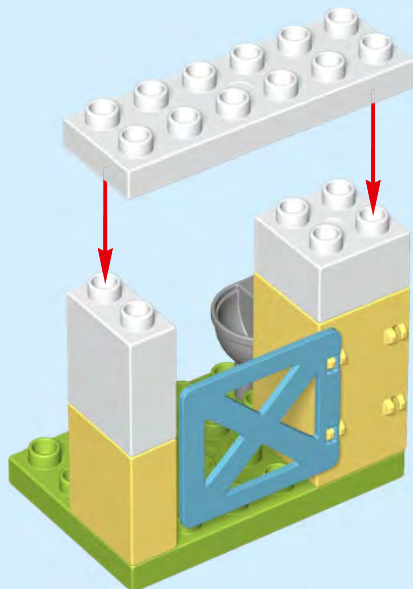

14





5

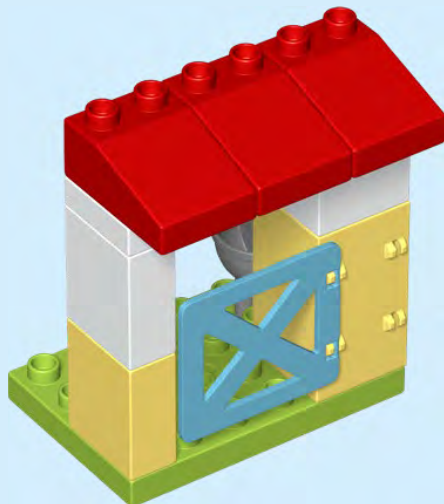



Go to [www.LEGO.com/productfeedback](http://www.LEGO.com/productfeedback)  
and give us your short  
**win**  
**feedback** about this  
LEGO® DUPLO® set for a chance to win  
a cool LEGO prize

Terms & Conditions apply

## LEGO.com/productfeedback

### GEWINNE

Erzähle uns auf  
[www.LEGO.com/productfeedback](http://www.LEGO.com/productfeedback)

etwas über die Erfahrungen, die du  
mit diesem LEGO® Set gemacht hast,  
und sichere dir die Chance auf einen  
coolen LEGO Preis!

Es gelten die Teilnahmebedingungen

### GAGNE

Rends-toi sur  
[www.LEGO.com/productfeedback](http://www.LEGO.com/productfeedback)

et donne-nous quelques commen-  
taires sur ce produit LEGO® pour  
avoir une chance de gagner un  
prix LEGO !

Voir Conditions Générales

### GANA

Visita  
[www.LEGO.com/productfeedback](http://www.LEGO.com/productfeedback)

y envíanos tu opinión acerca de este  
set LEGO®. ¡Participarás en el sorteo  
de un premio LEGO!

Términos y Condiciones aplicables

### 获取奖品

登录  
[www.LEGO.com/productfeedback](http://www.LEGO.com/productfeedback)

给出关于此乐高®套装的简短反  
馈，就有机会获得炫酷乐高奖品

《条款及条件》适用

LEGO, the LEGO logo, DUPLO and the DUPLO logo are trademarks of the/son des marques de commerce du/son marcas registradas de LEGO Group.  
©2021 The LEGO Group. All rights reserved/Tous droits réservés/Todos los derechos reservados.

6362455