



STAR WARS™

75298



Disney

TM!by
ONLINE STORE

<https://tm.by>
Интернет-магазин

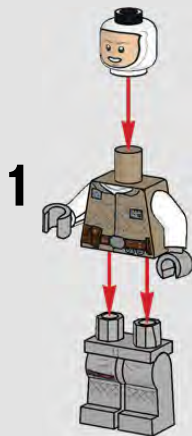

2

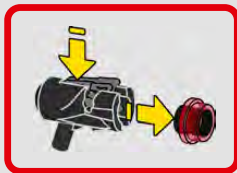
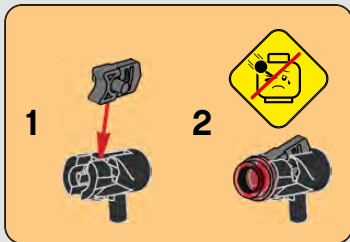

2



3

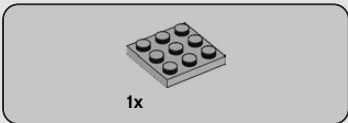

1



4

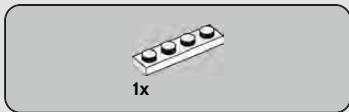

2



3

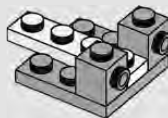

5



1x

5

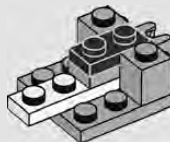

2x

6

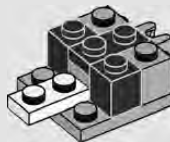

7



2x

7

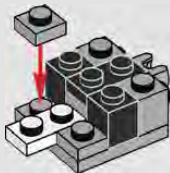

8

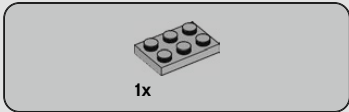

8

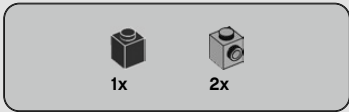
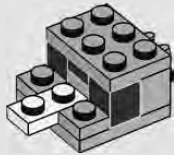

9

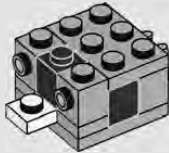

9



1x

10

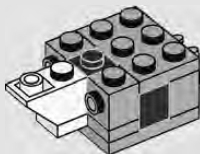

10



11

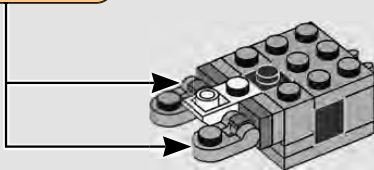
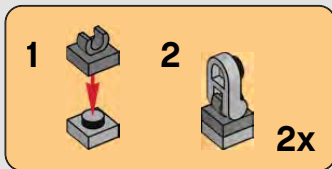

11

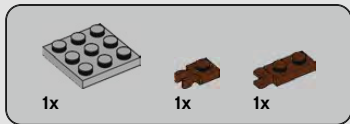

12

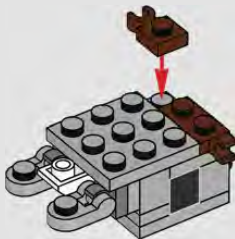

12



13

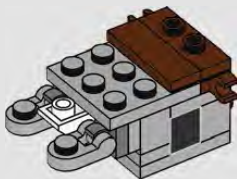

13

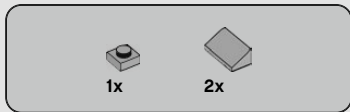

14

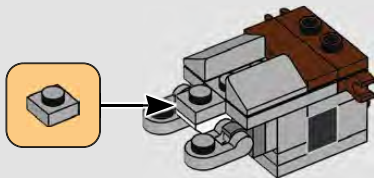

14



1x



1x

15

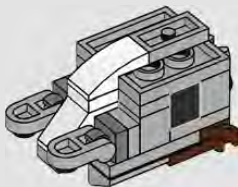

15



2x

16

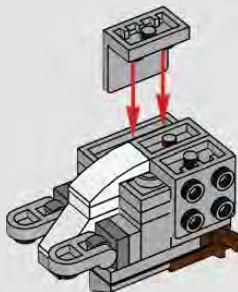

16

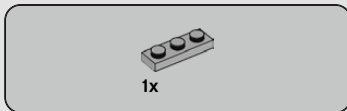

17

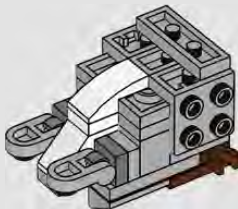

17

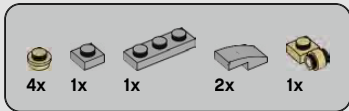

18

1

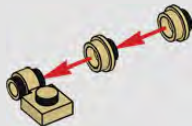

2



18

3

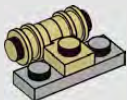

4

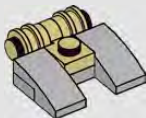

5

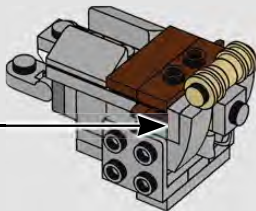
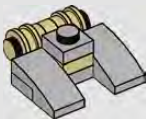

19

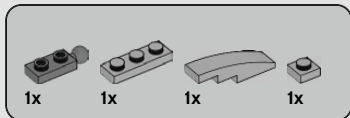

19

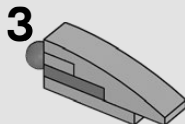
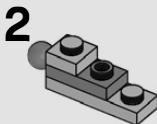
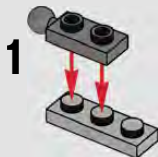

20

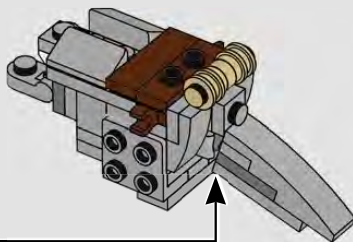

21

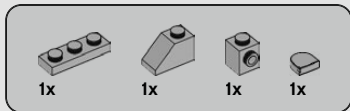

20

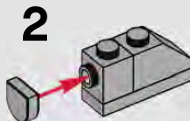
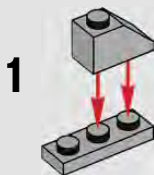

22

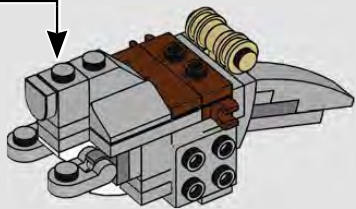

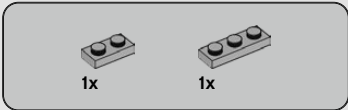

21

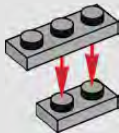

24

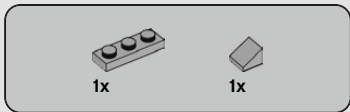

22

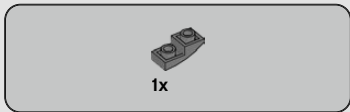
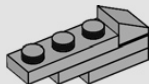

23

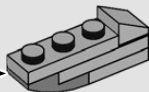

25



1x



1x

24

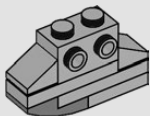

26



2x

25

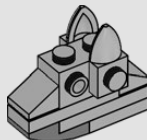

2x

26

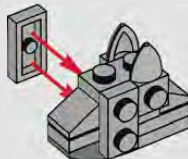

27



2x



1x

27

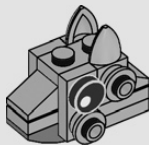

28



28



29



29



1x

30



30



1x

32

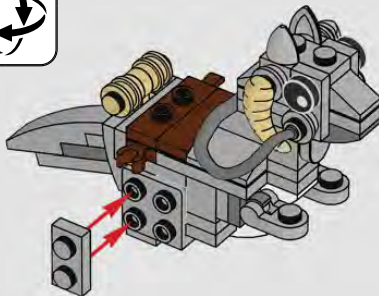

32

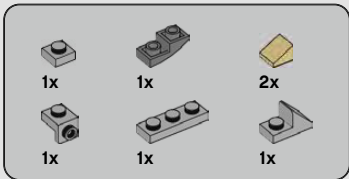

33

1



33

2



3



4

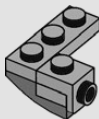

5

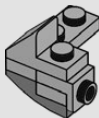

34



6

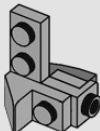

7

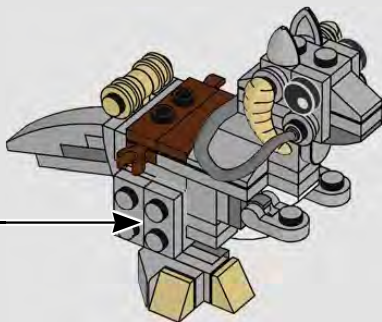
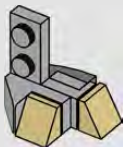

35

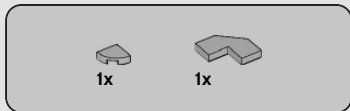

34

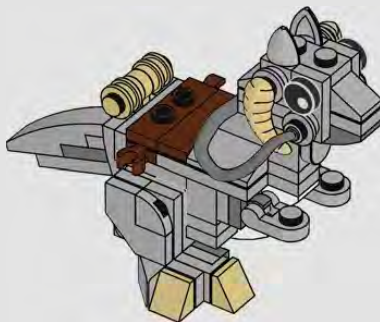

36



1x

35

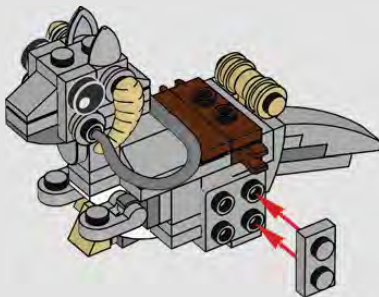

37



1x



1x



2x



1x



1x



1x

36

1



38

2



3



4

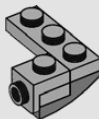

5





6

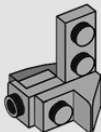

7

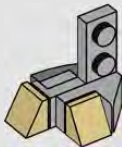

40

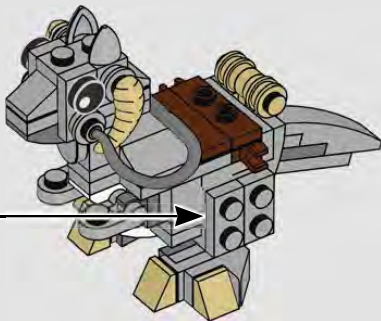

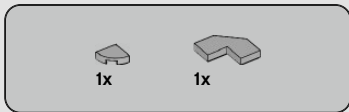

37

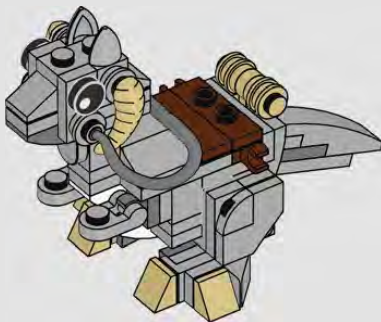

41

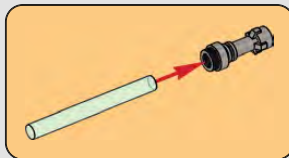
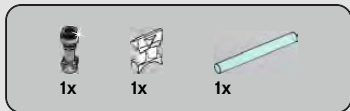

38

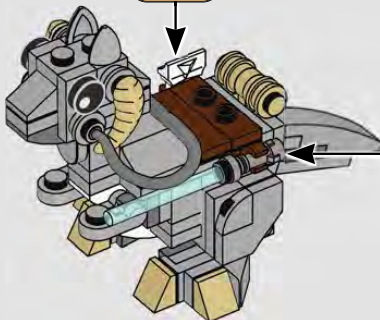

42

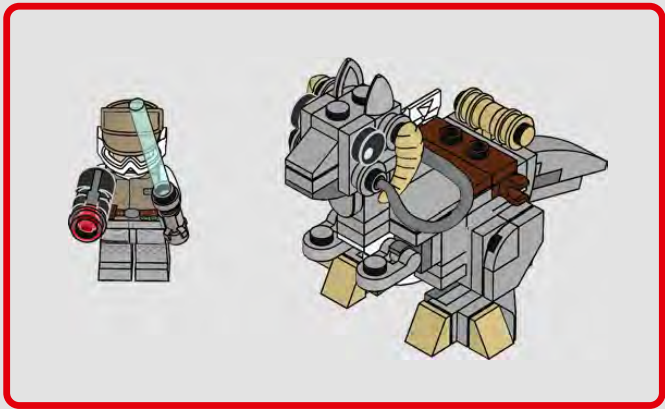



LEGO and the LEGO logo are trademarks of the/son des marques de commerce du/son
marcas registradas de LEGO Group. ©2021 The LEGO Group.
© & ™ Lucasfilm Ltd.

6352019/6352020

TM!by
ONLINE STORE

<https://tm.by>
Интернет-магазин