



CITY

60197



 LEGO.com/city

TM.by
ONLINE STORE

<https://tm.by>
Интернет-магазин

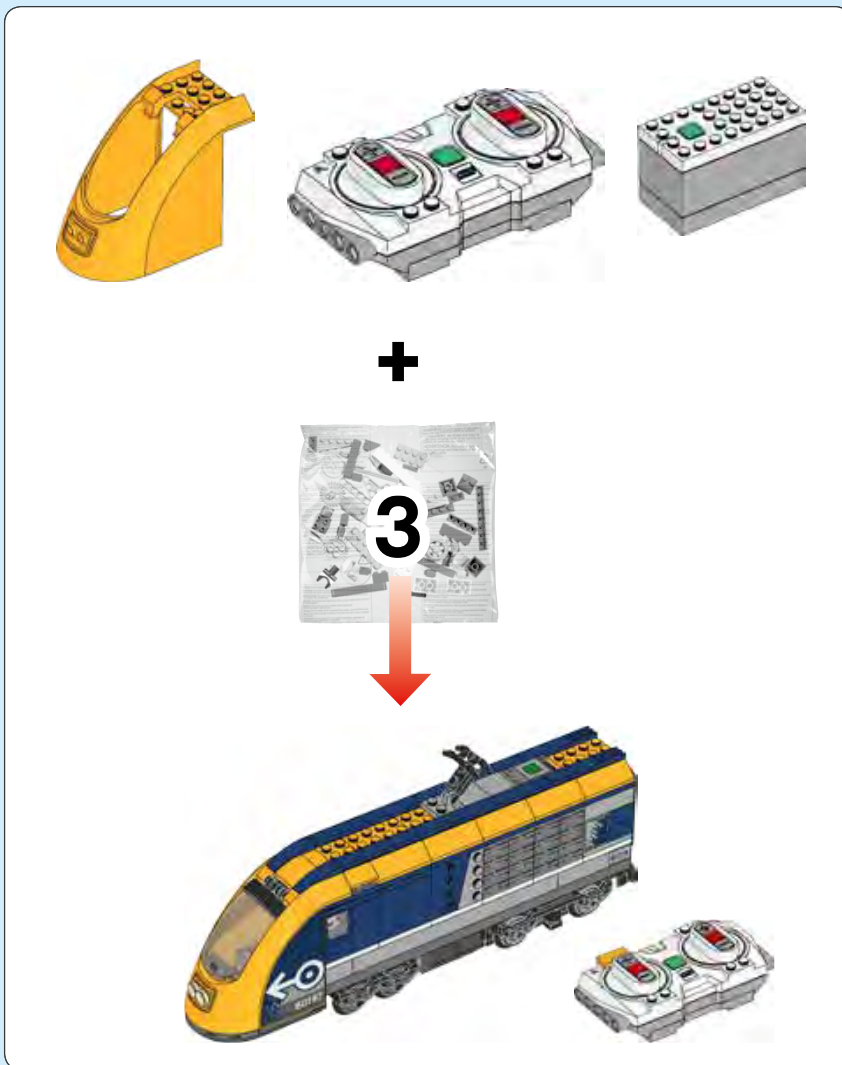

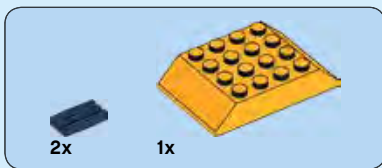

58

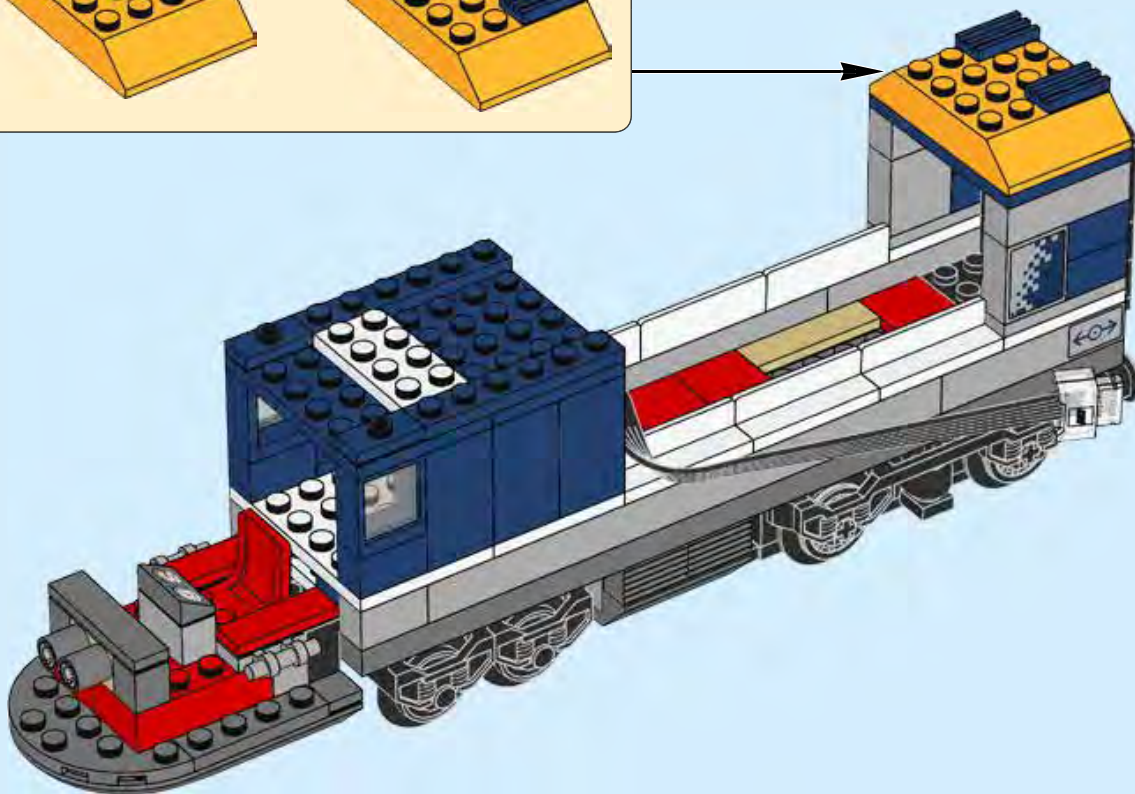
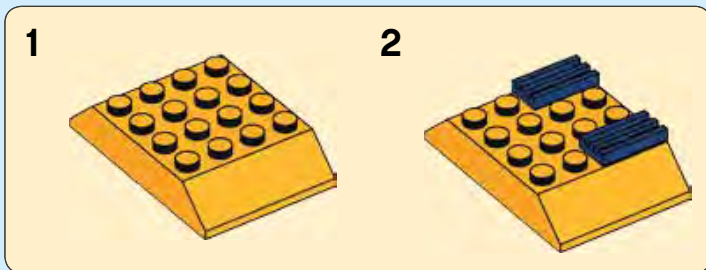

3



59

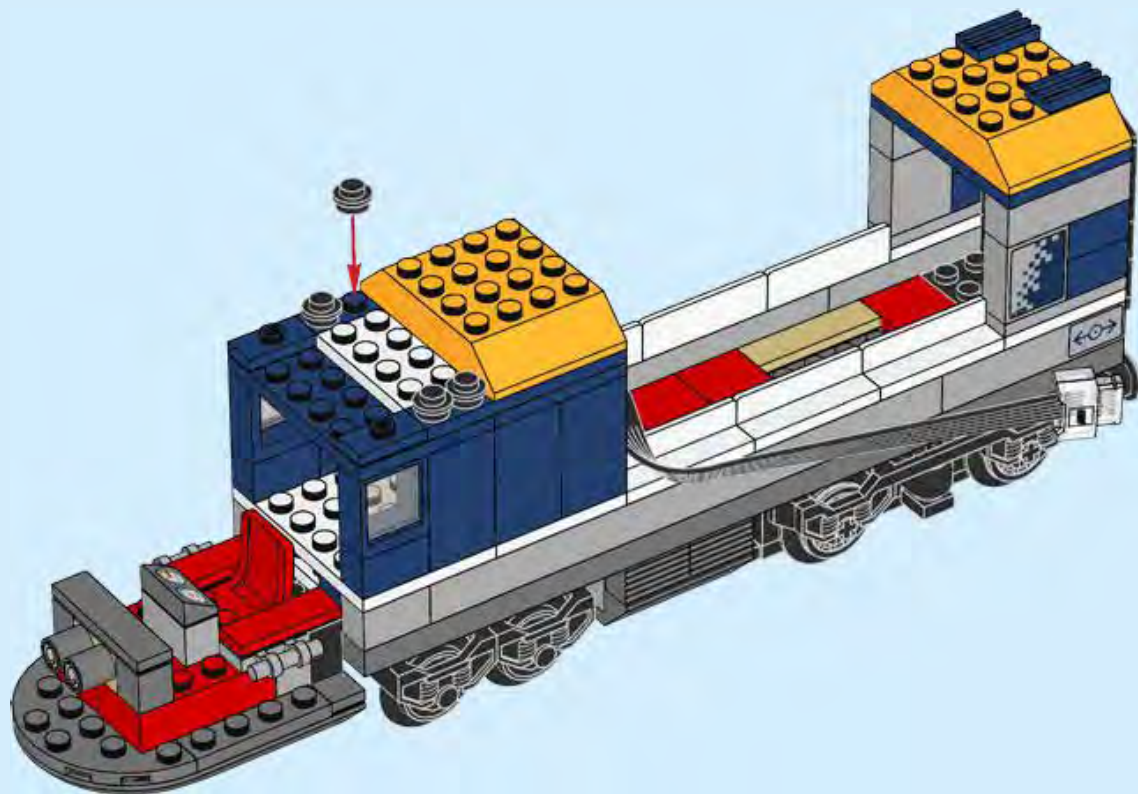

4

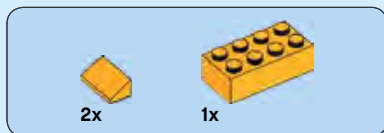

60

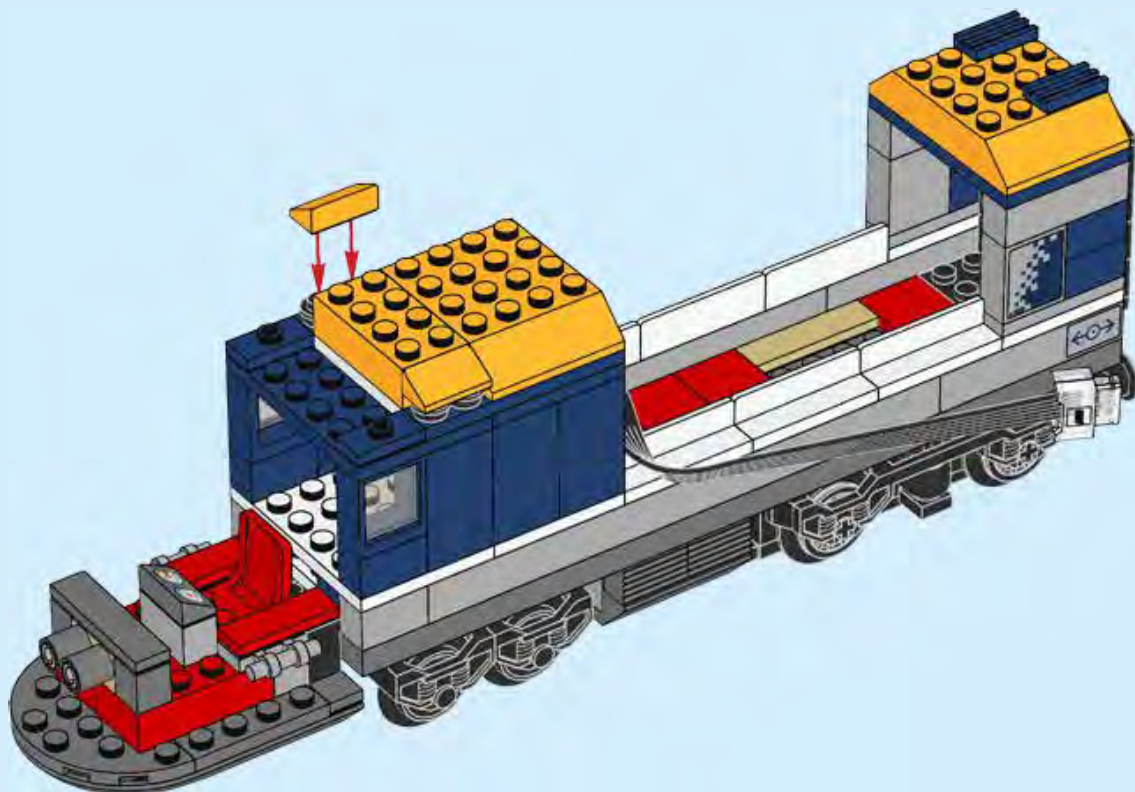



2x

61

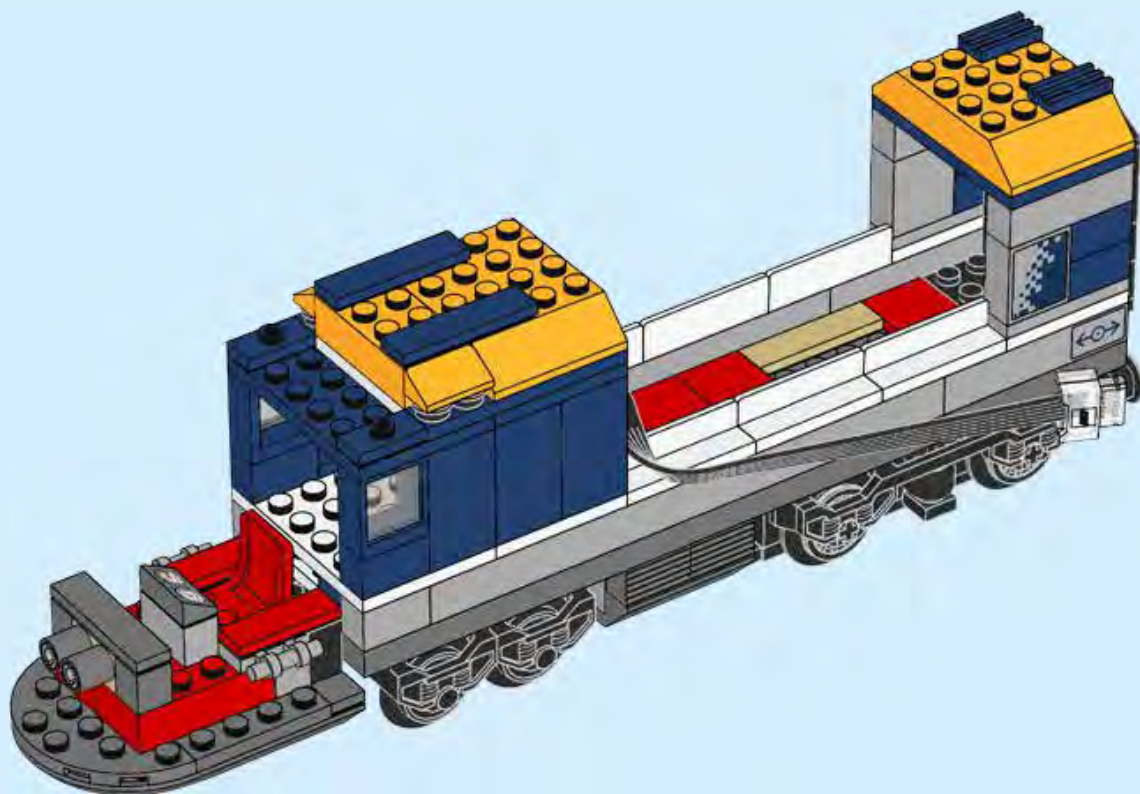

6

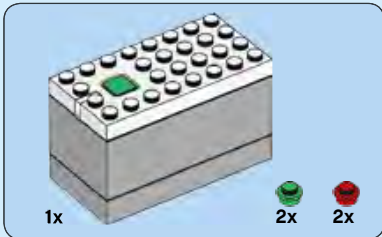

62

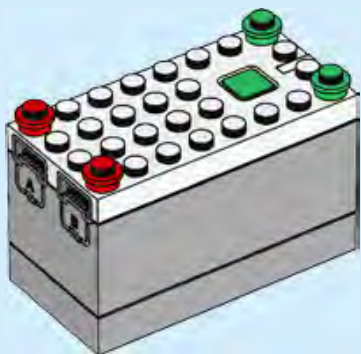

63

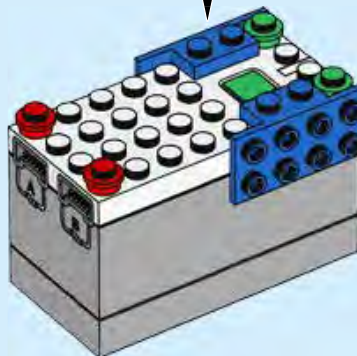



2x

64

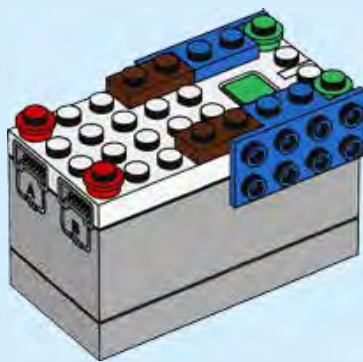

8



65

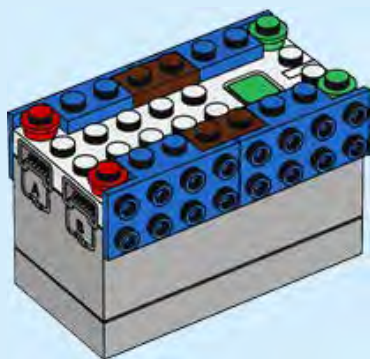

66

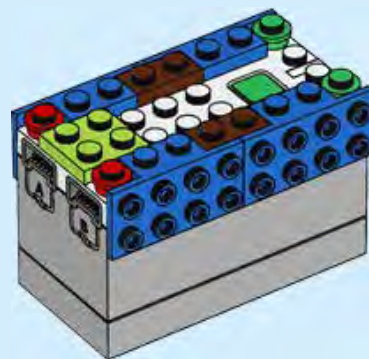



1x

67

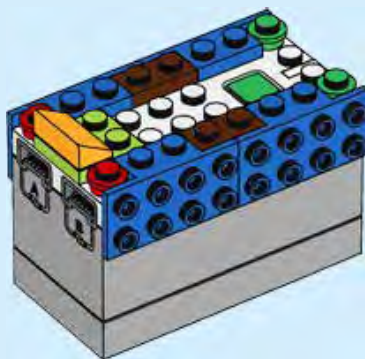

10

68

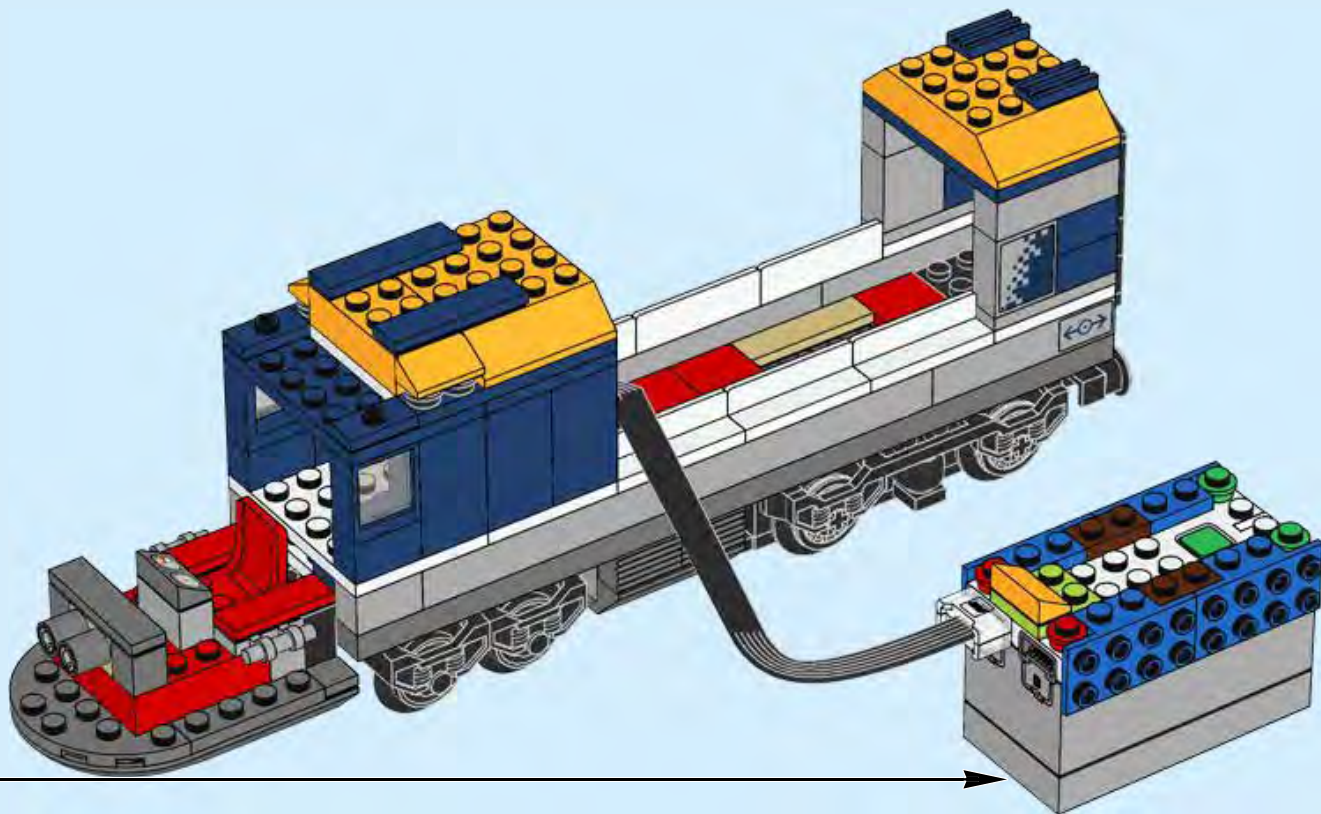

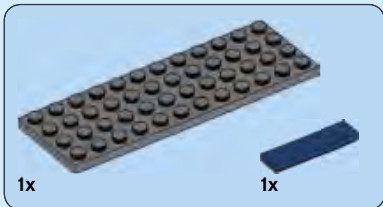

69

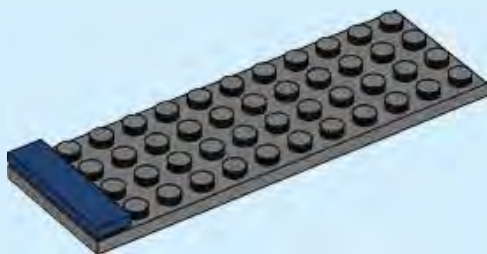

70

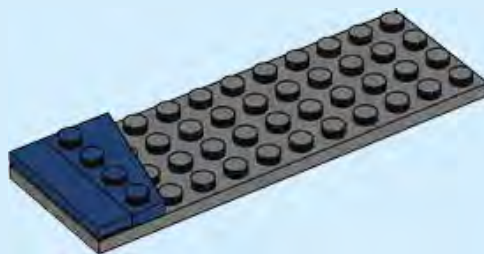



71



72

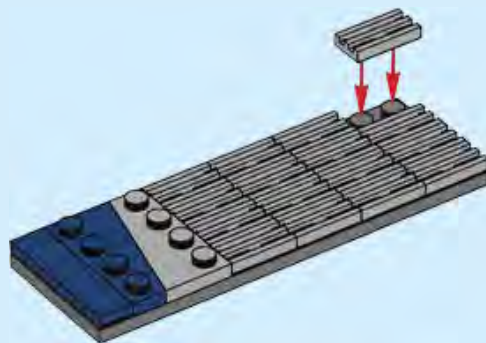

73

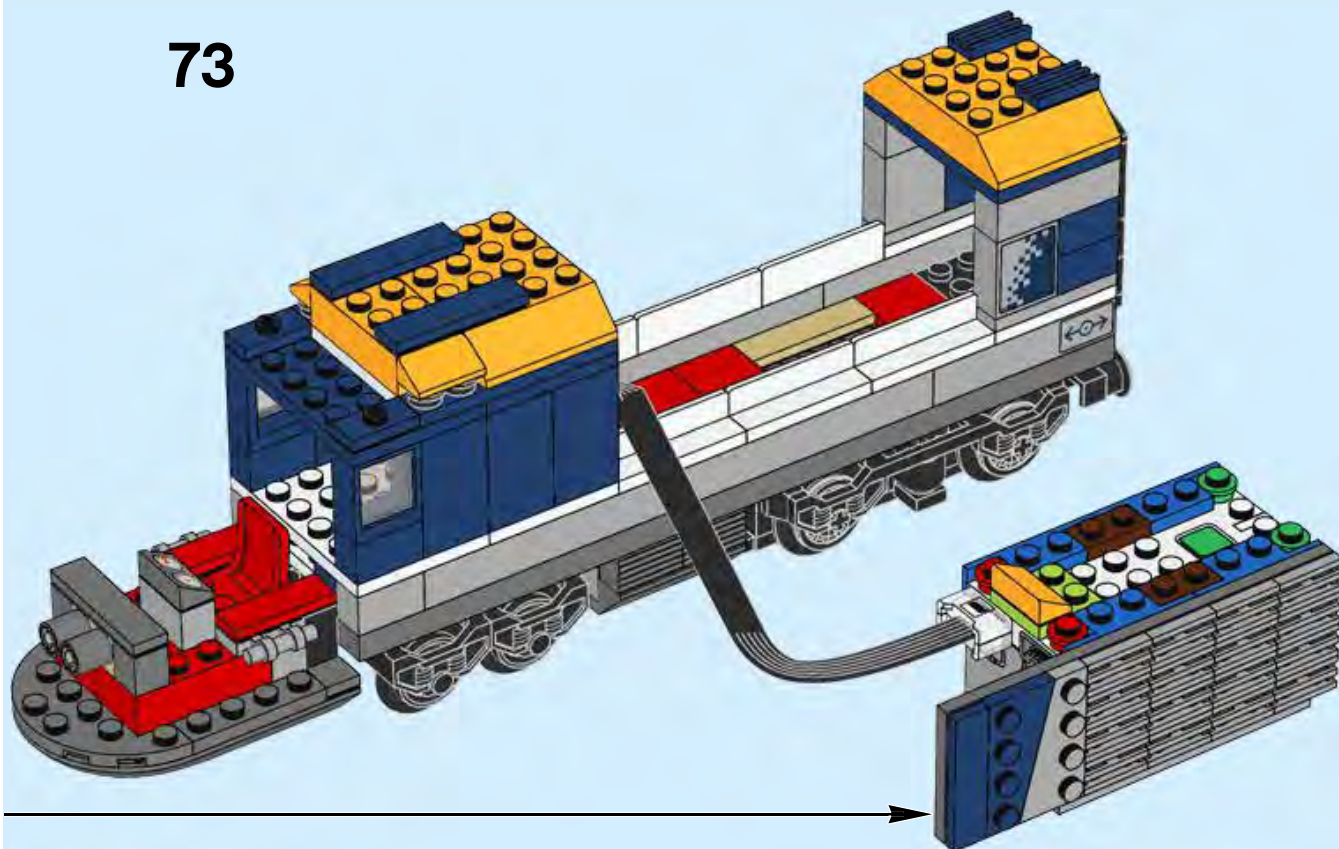

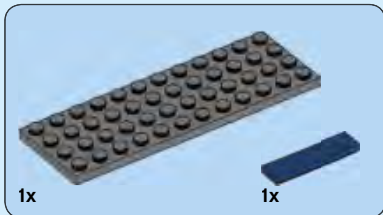

74

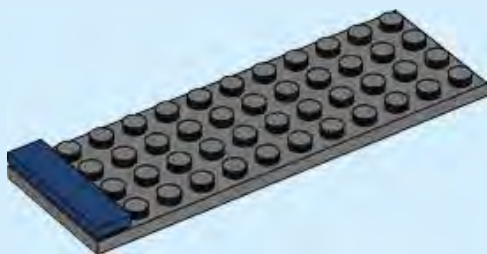

75





1x

76



16x

77

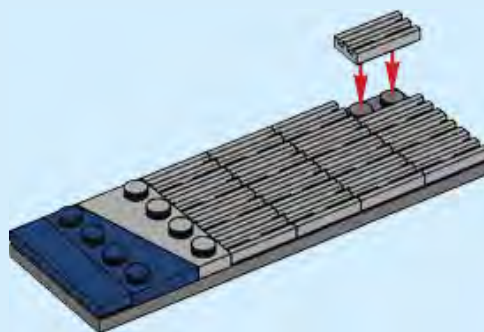

78

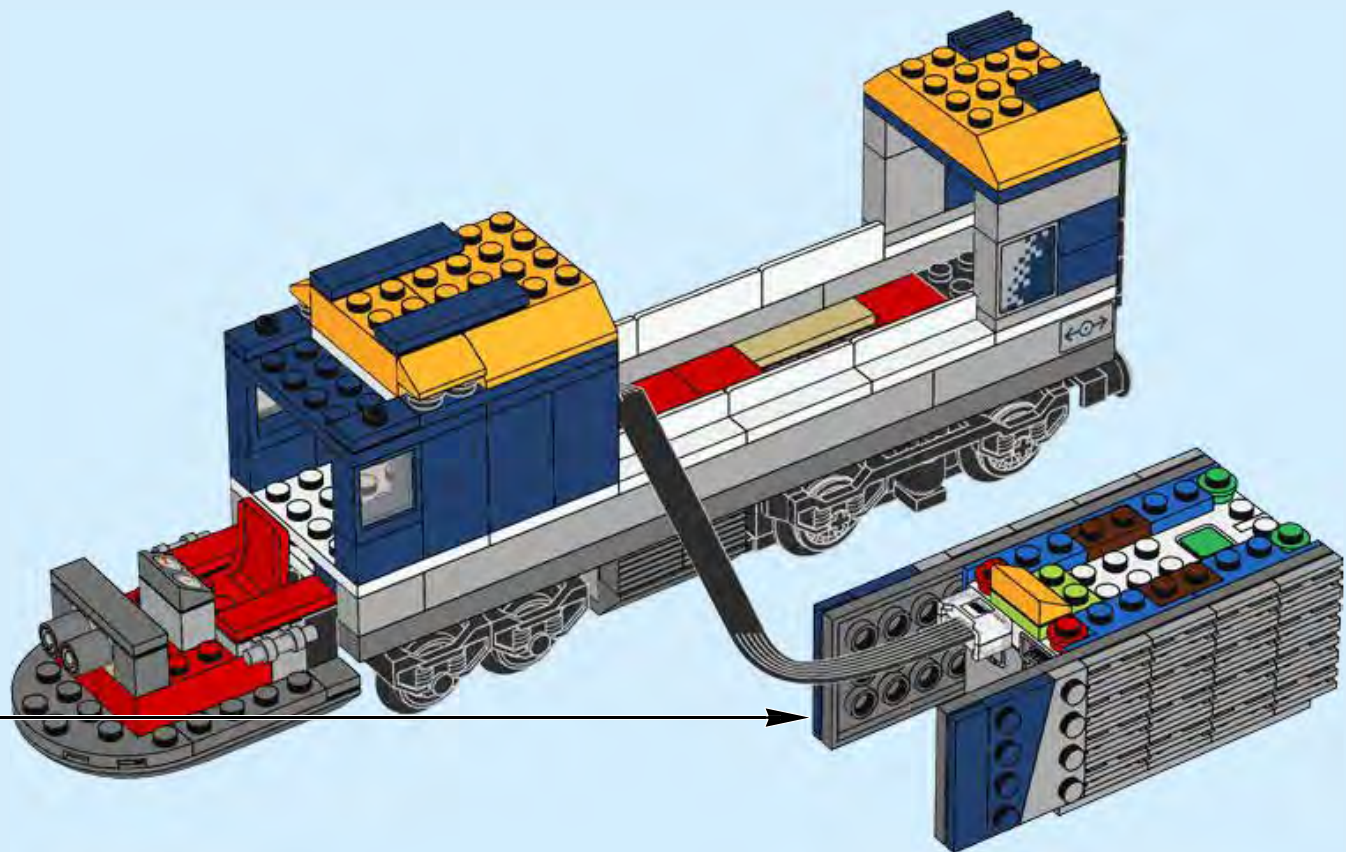



79

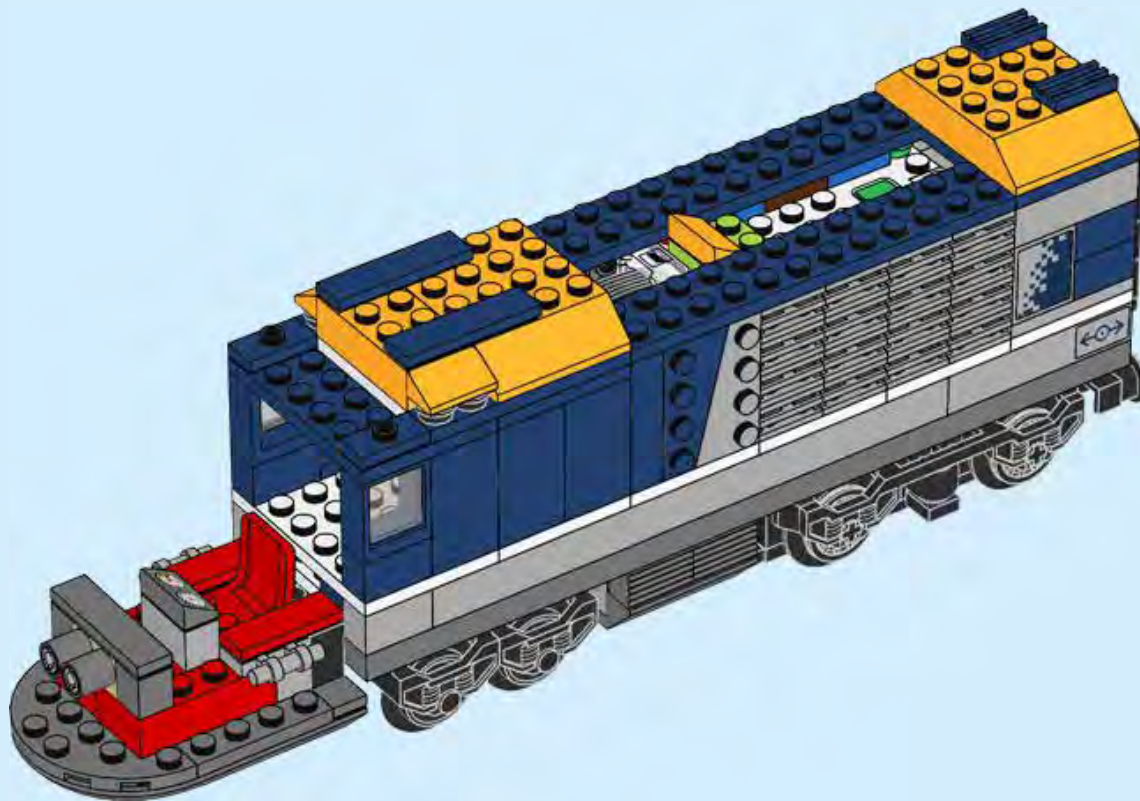

18



80

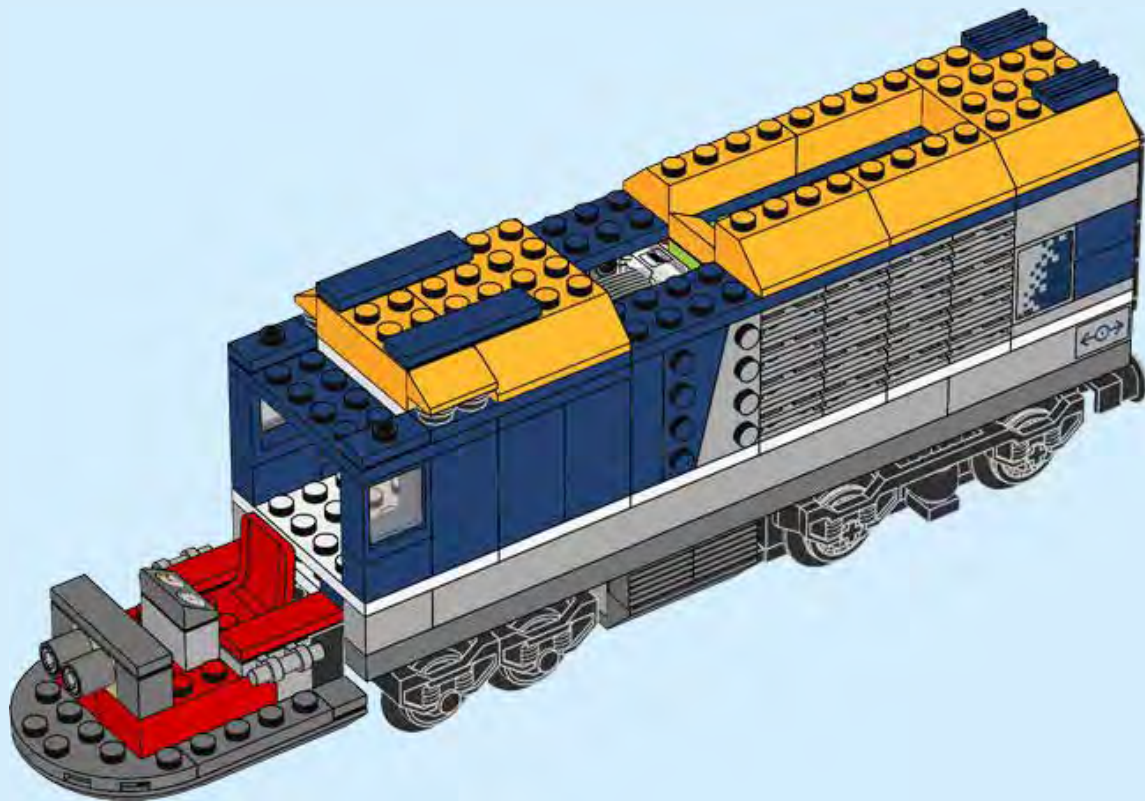

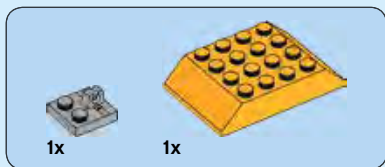

81

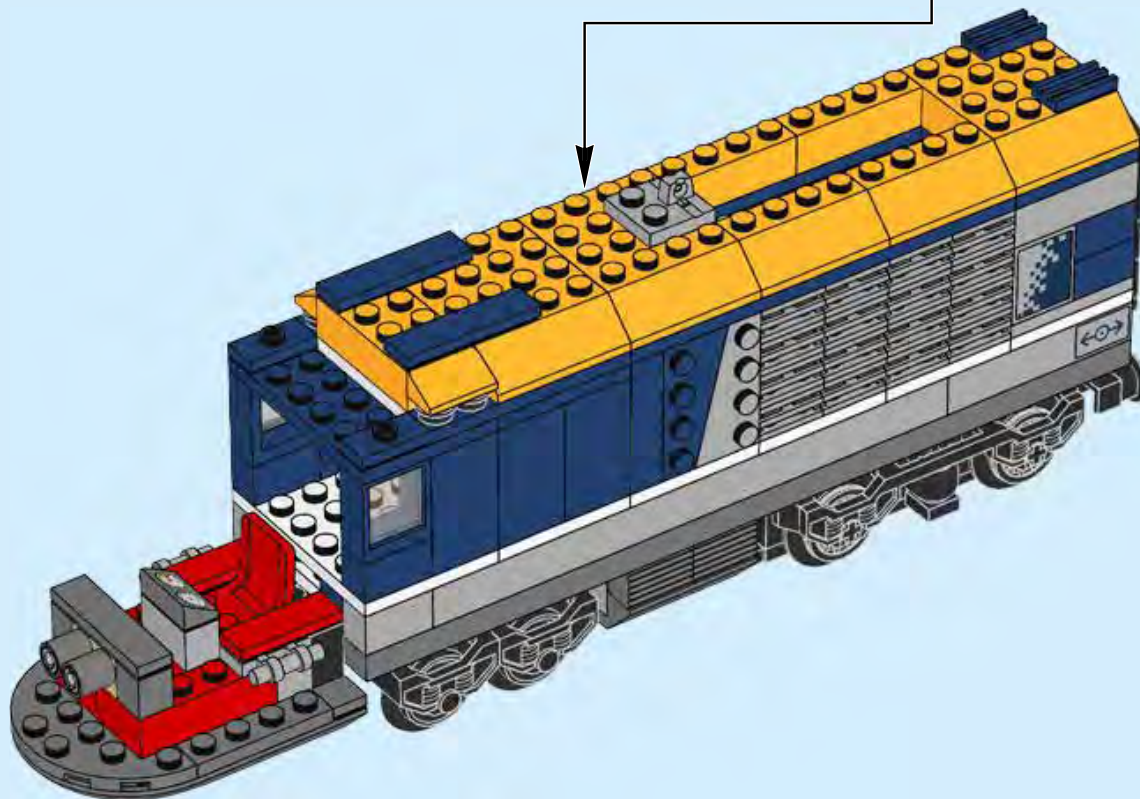
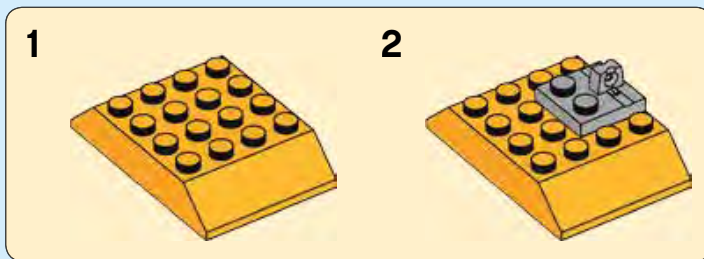

20

8x

82

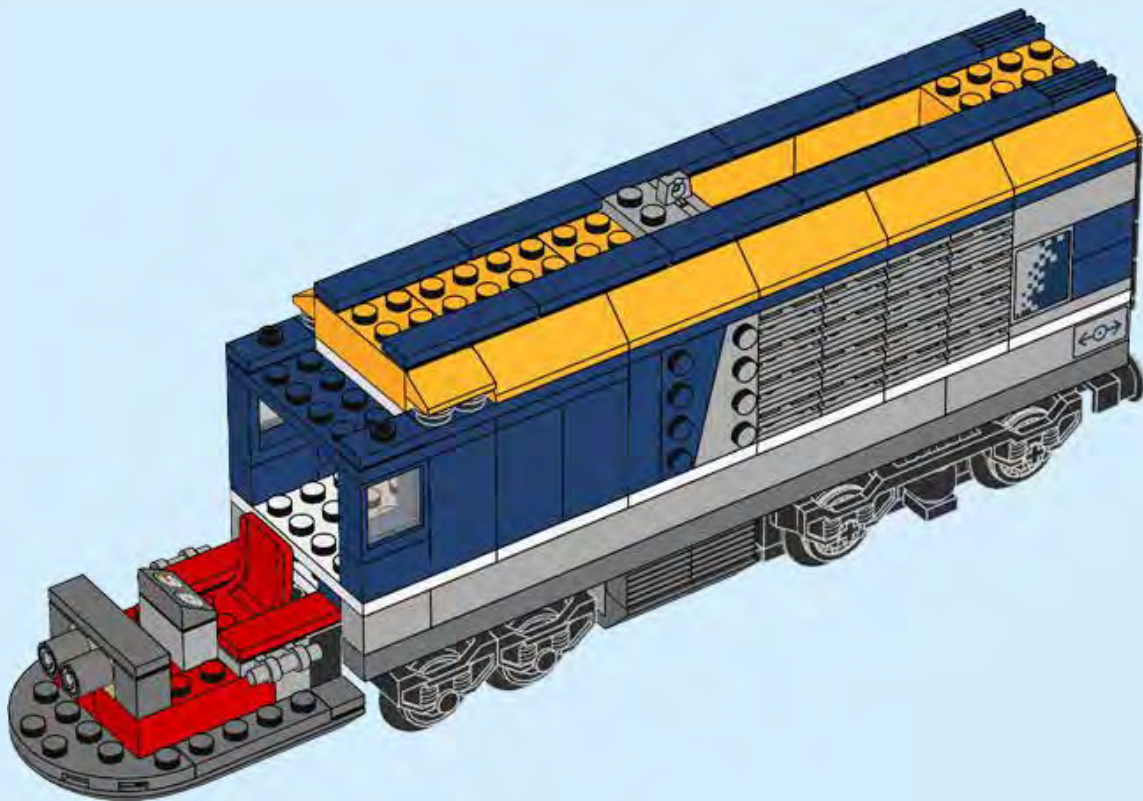

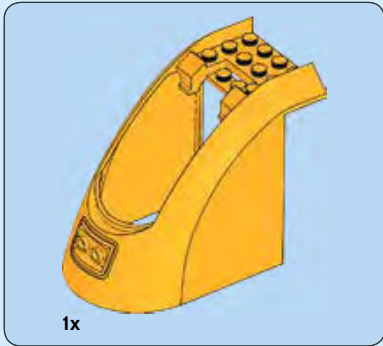

83

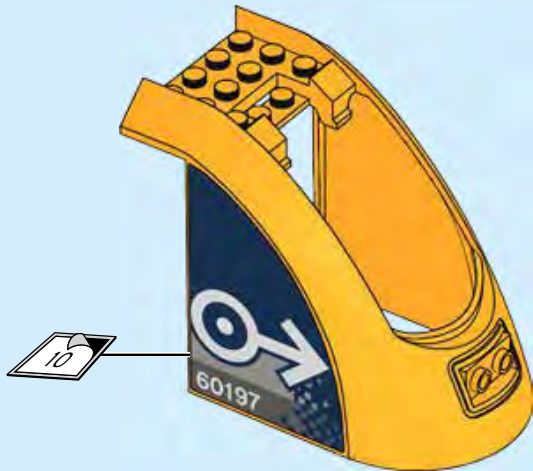

22

84

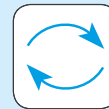

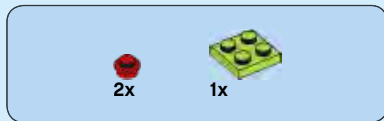

85



86





1x



1x

87

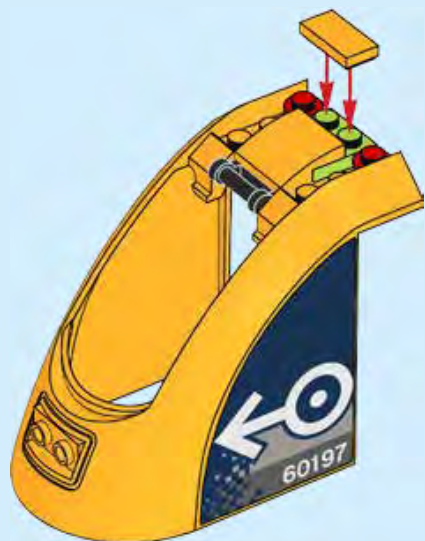

24



2x

88





89





2x

90



26

91



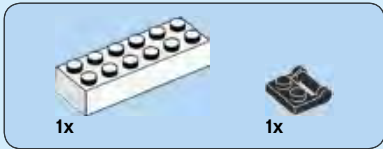

92

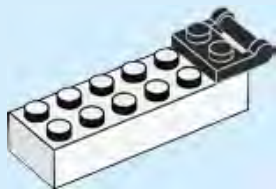

93





94

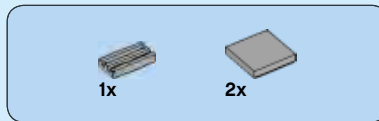
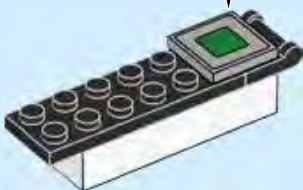
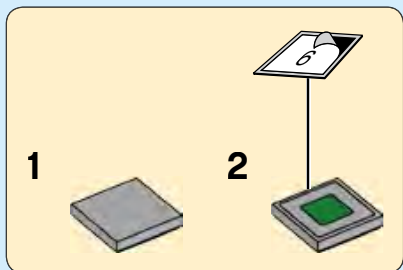

95

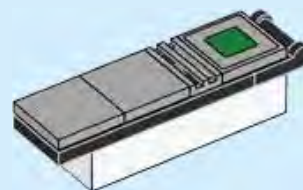



1x

96

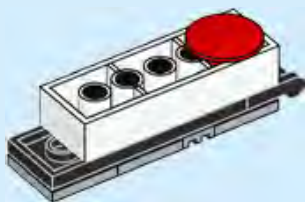
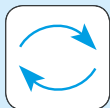

97

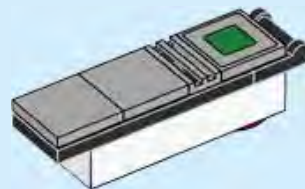
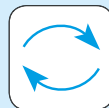

30

98



31





99



100



34

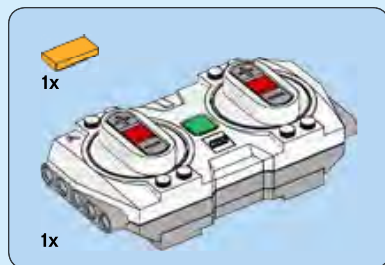

101



LEGO CITY



LEGO and the LEGO logo are trademarks of the/son des marques de commerce du/son marcas registradas de LEGO Group. ©2018 The LEGO Group. 6247027

TM.by
ONLINE STORE

<https://tm.by>
Интернет-магазин