

Ultra-10 (swivel)

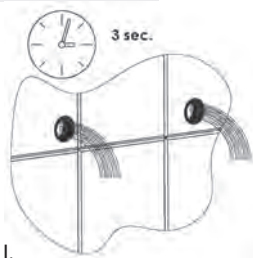

I.



II.

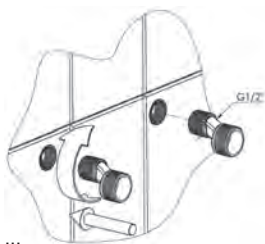

III.

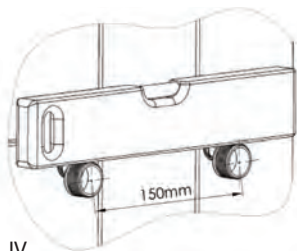

IV.

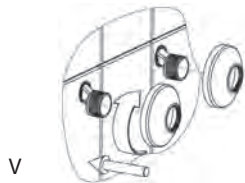

V.



VII.

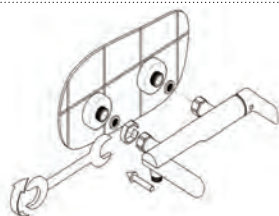

VI.

RUBINETA



ULTRA

UAB „Rubineta“
Savanorių pr. 180, LT-03154 Vilnius
www.rubineta.com

COMPANY WITH
QUALITY SYSTEM
CERTIFIED BY DNV GL
= ISO 9001 =

Ultra-10/K (swivel)

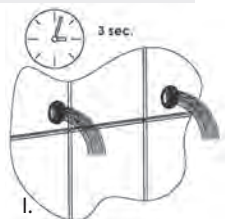

I.



II.

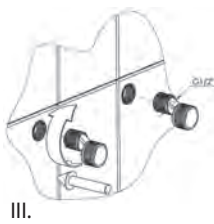

III.

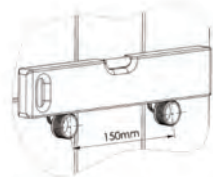

IV.

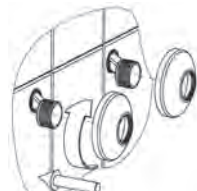

V.

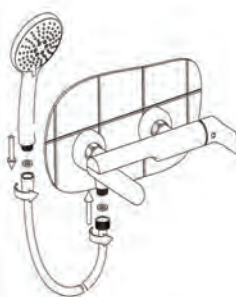

VII.

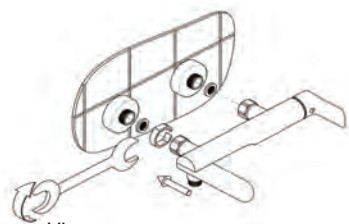

VI.

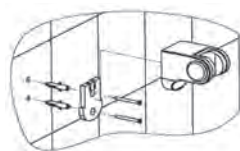

VIII.



IX.

Ultra-12

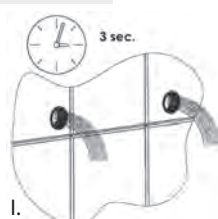

I.



II.

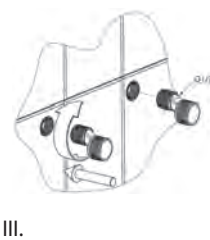

III.



IV.

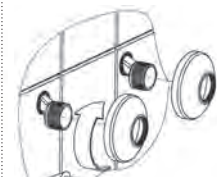

V.

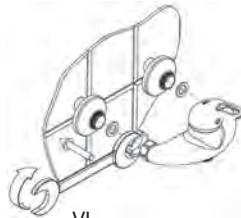

VI.

EN

Low pressure kitchen faucet Ultra-25 has 3 connection hoses and is suitable for usage with pressureless water heaters (boiler, instant water heaters etc).

Warning!

After faucet ceramic cartridge is closed, it is normal for water to drip for about 1 minute. This phenomenon occurs due to the faucet design itself. This is the reason, why prolonging hoses or flow controller should not be connected to faucet's spout. After the closure, little more water may drip from the faucet, if expansion vessels with a plastic / rubber reservoir are being used. Aerator is made differently for the low pressure faucet and we must be very attentive on this.

SRB

Nisko pritiska kuhinjska jednoručna baterija Ultra-25 sa tri creva. Koristi se kod niskopritisnih bojlera i protočnih bijlera za nisku montažu.

Upozorenje!

Nakon što se keramički mešač zatvori, normalna je pojava kapljanja vode na izlivu oko 1 min. Ovo je normalna pojava ujednačavanja pritiska iz bojlera i stoga produžetke i kontrolore protoka ne treba priključivati na izliv baterije. Vreme kapanja može biti i duže ako je ekspanzioni sud bojlera od plastike ili gume. Aerator- perlator za baterije niskog pritiska zbog tehničkih zahteva sistema se razlikuju od običnih perlatora i prilagođeni su tehničkim specifičnostima i standardima zahteva za upotrbom na bojlerima niskog pritiska.

Ultra-33 | Ultra-35
Ultra-37

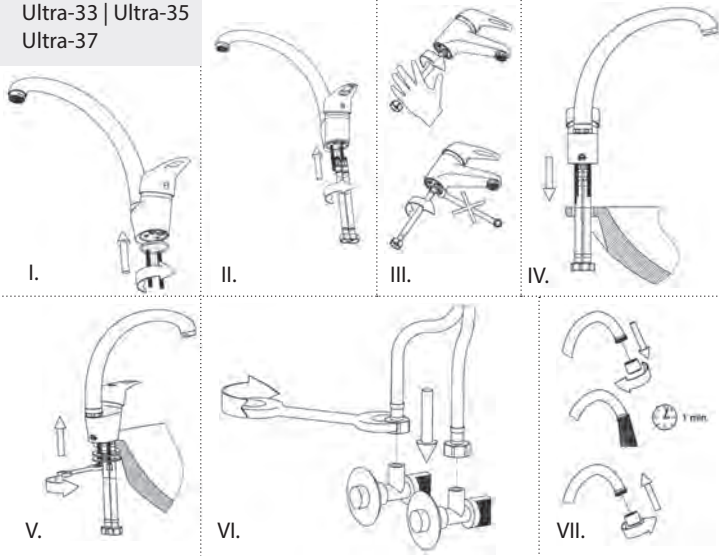

Ultra-12/K

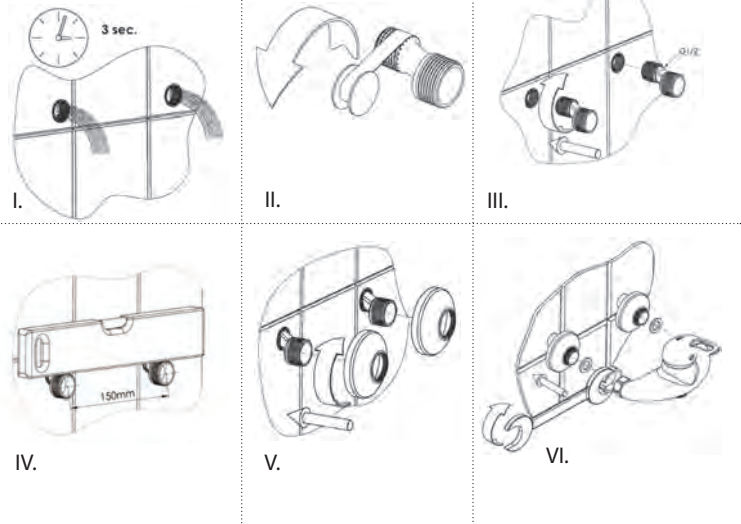

Ultra-15 | Ultra-15/D

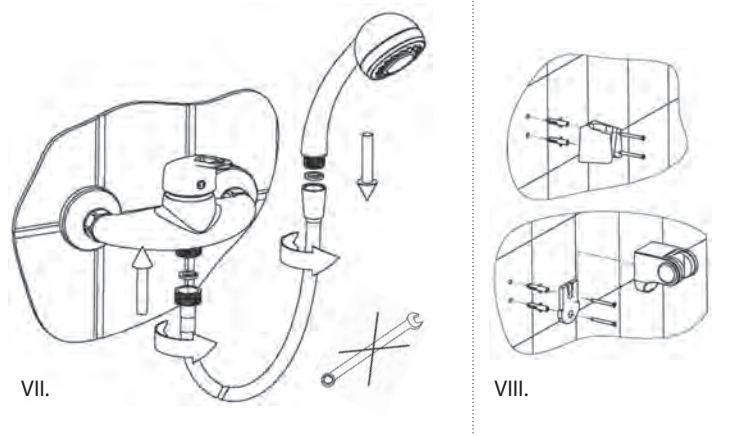
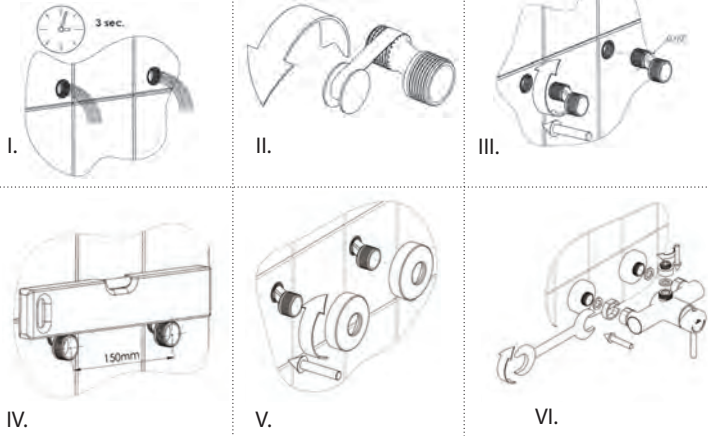

Ultra-16
Ultra-18
Ultra-18/D

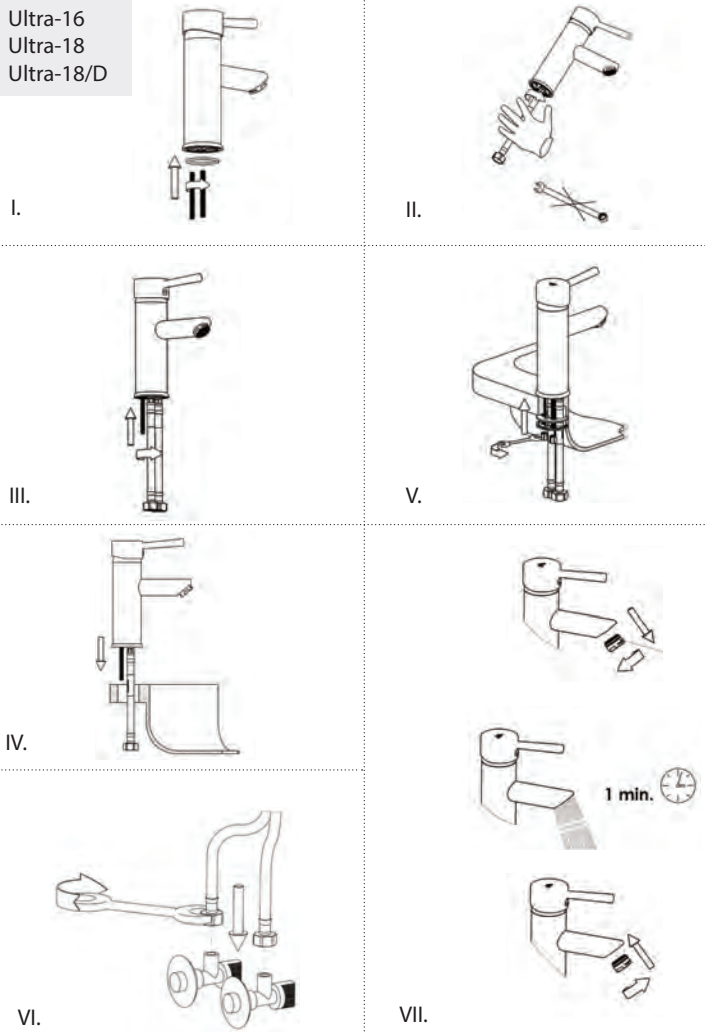

Ultra-25

