

Canon

LBP6030w

LBP6030B

LBP6030

Getting Started	En
Mise en route	Fr
Erste Schritte	De
Introduzione	It
Introducción	Es
Sådan kommer du i gang	Da
Aan de slag	Nl
Komme i gang	No
Komma igång	Sv
Aloittaminen	Fi
Начало работы	Ru
Pierwsze kroki	Pl
Başlangıç	Tr
بدء التشغيل	Ar

FT6-0754 (000)

For some languages not listed above, documentation is provided in PDF format on the CD-ROM/DVD-ROM.

Installing the Printer

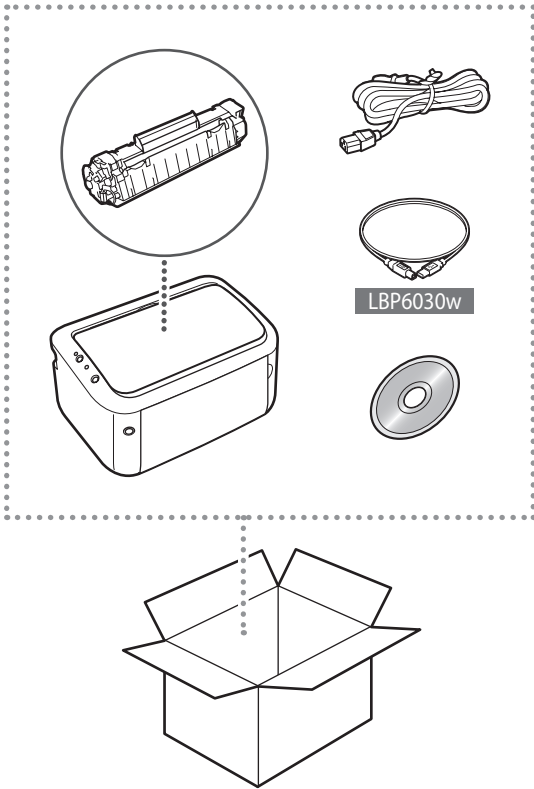

Installation Requirements

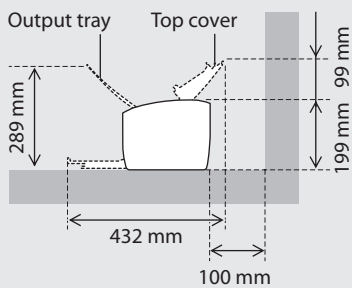
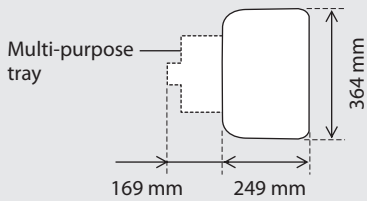

Remove all the tape.

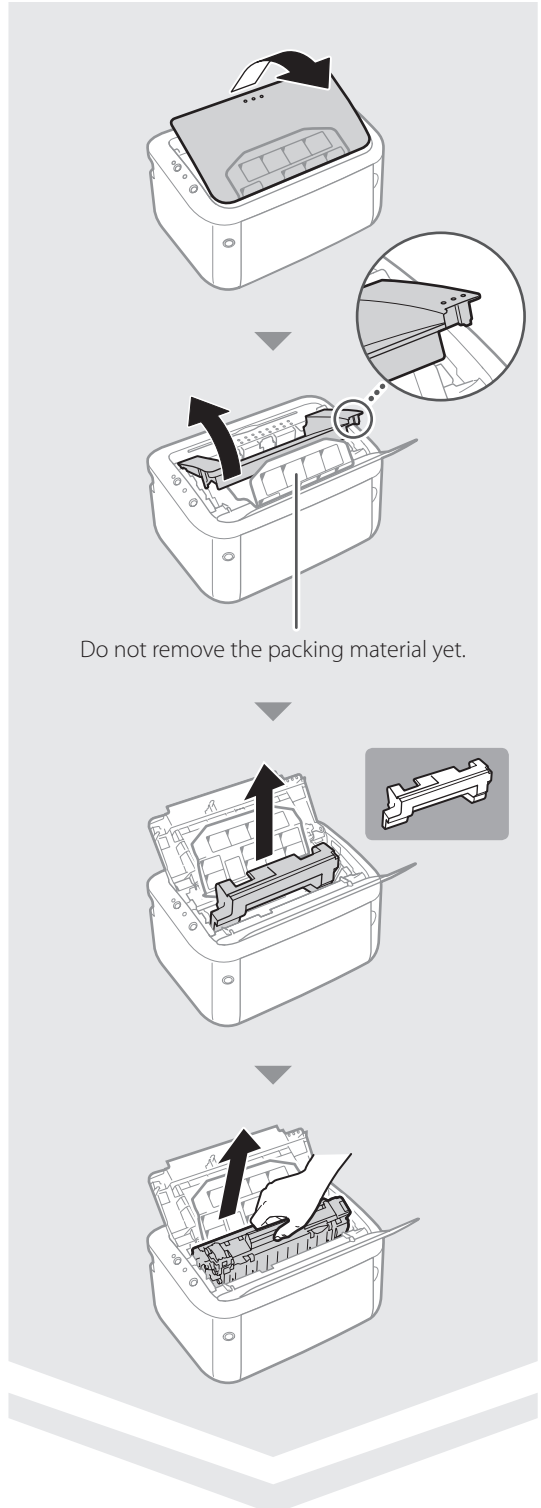

Do not remove the packing material yet.

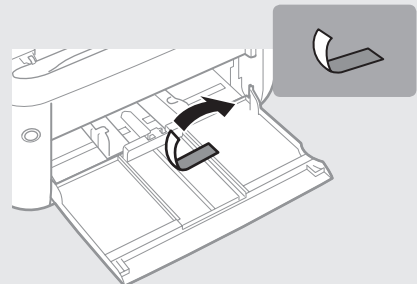
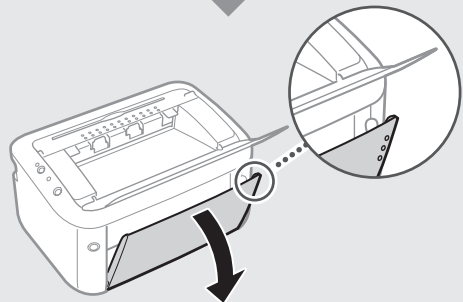
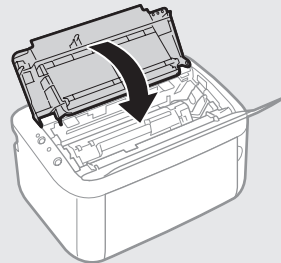
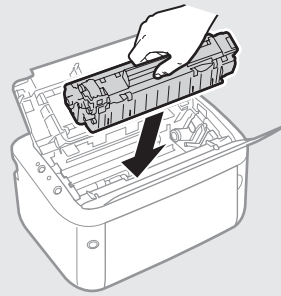
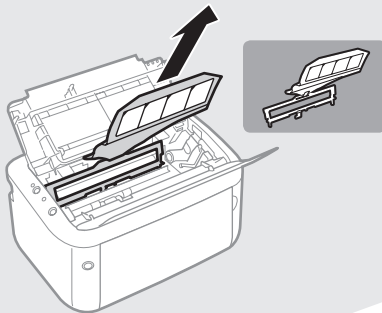
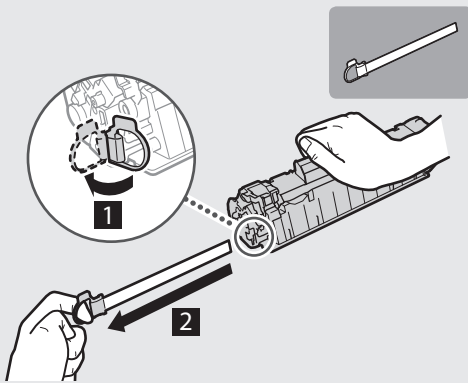
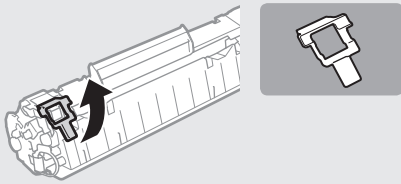
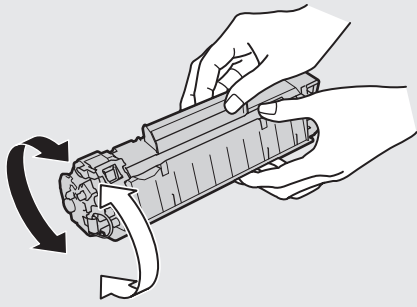

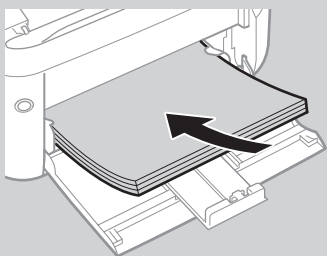
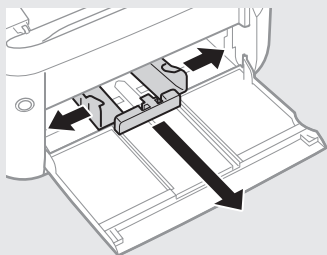

Keep the paper stack within the load limit guides.

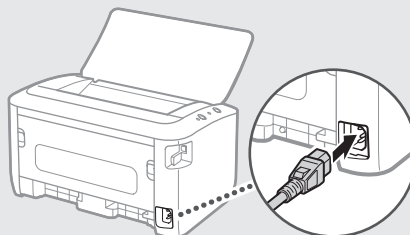
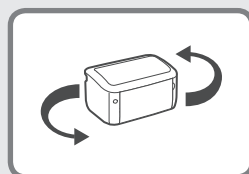
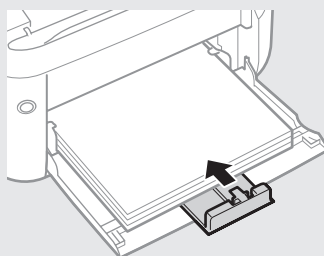
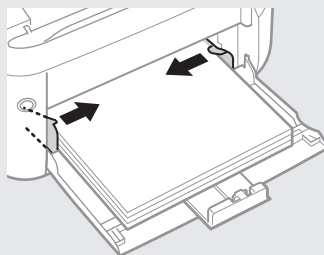
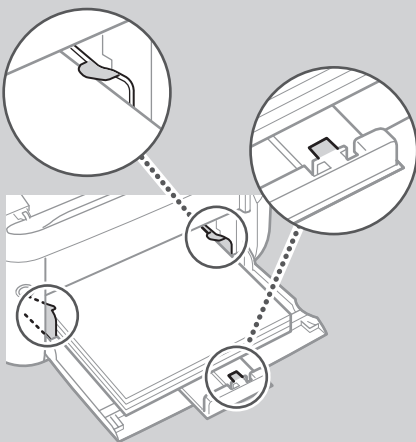

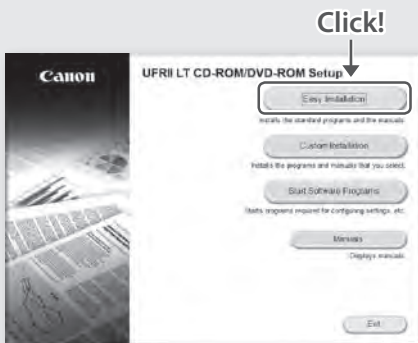
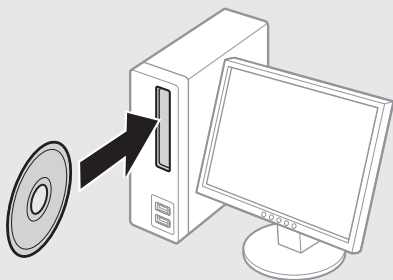
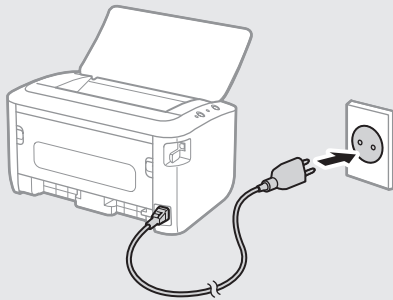

Follow the instructions on the screen.

» Next, see e-Manual and the Feature Highlights.

Double Click!

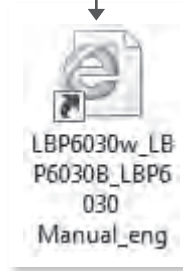

Top Page

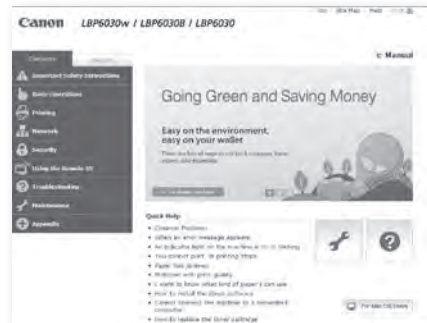

Topic Page



For Macintosh Users

If you are using Macintosh, see the "Printer Driver Guide for Macintosh" (HTML manual) and the "e-Manual" (HTML manual) included in the supplied CD-ROM/DVD-ROM also.

Fr Si vous utilisez Macintosh

Si vous utilisez Macintosh, consultez le "Guide du pilote d'imprimante pour Macintosh" (manuel HTML) et le manuel électronique (manuel HTML) également inclus sur le CD-ROM/DVD-ROM.

De Für Anwender von Mac OS

Wenn Sie Macintosh verwenden, ziehen Sie die "Druckertreiber-Handbuch für Macintosh" (HTML-Anleitung) und die "e-Anleitung" (HTML-Anleitung) zu Rate, die sich ebenfalls auf der mitgelieferten CD-ROM/DVD-ROM befinden.

It Per utenti Macintosh

Se si utilizza un Macintosh, vedere la "Guida del driver della stampante per Macintosh" (manuale HTML) e l'"e-Manual" (manuale HTML) incluso anche nel CD-ROM/DVDROM fornito.

Es Para usuarios de Macintosh

Si está usando Macintosh, consulte la "Guía del controlador de impresora para Macintosh" (manual HTML) y el "e-Manual" (manual HTML) incluido en el CD-ROM/DVDROM suministrado.

Da For Macintosh-brugere

Hvis du bruger Macintosh, henvises du til "Printer Driver Guide for Macintosh" (HTML-manual) og "e-Manual" (HTML-manual), der også kan findes på den medfølgende cd-rom/dvd-rom.

Nl Voor Macintosh-gebruikers

Zie als u Macintosh gebruikt de "Printer Driver Guide for Macintosh" (HTML-handleiding) en ook de "e-Handleiding" (HTML-handleiding) op de meegeleverde CD-ROM/DVDROM.

No For Macintosh-brukere

Hvis du bruker en Macintosh, se "Printer Driver Guide for Macintosh" (HTML-håndbok) og "e-håndbok" (HTML-håndbok) som følger med på den vedlagte CD-ROM-en/DVD-ROM-en.

Sv För användare av Macintosh

Om du använder Macintosh finns även information i "Printer Driver Guide for Macintosh" (HTML-handbok) och "e-handboken" (HTML-handbok) som finns på den medföljande cd-/dvd-skivan.

Fi Macintosh-käyttäjät

Jos käytät Macintoshia, katso myös toimitukseen kuuluvalla CD-ROM/DVD-ROM-levyllä olevat oppaat "Printer Driver Guide for Macintosh" (HTML-opas) ja "Sähköinen opas" (HTML-opas).

Ru Для пользователей Macintosh

Если Вы используете Macintosh, см. "Printer Driver Guide for Macintosh" (Руководство по драйверу принтера для Macintosh) (в формате HTML) и "Электронное руководство пользователя" (в формате HTML), включенные во входящий в комплект поставки CD-/DVD-диск.

Pl Dla użytkowników komputerów Macintosh

Użytkownicy komputerów Macintosh powinni zapoznać się również z „Printer Driver Guide for Macintosh” (podręcznik w formacie HTML) oraz „e-Podręcznikiem” (podręcznik w formacie HTML), umieszczonymi na dostarczonym dysku CD-ROM/DVD-ROM.

Tr Macintosh Kullanıcıları İçin

Macintosh kullanıyorsanız, verilen CD-ROM/DVD-ROM'daki "Printer Driver Guide for Macintosh"na (HTML kılavuz) ve "e-Kılavuz"a da (HTML kılavuz) bakın.

Ar لمستخدمي نظام Macintosh

إذا كنت تستخدم نظام Macintosh، راجع "Printer Driver Guide for Macintosh" (دليل بتنسيق HTML) و"الدليل الإلكتروني" (دليل بتنسيق HTML) الموجود في الأسطوانة/قرص DVD المرفق مع الجهاز.

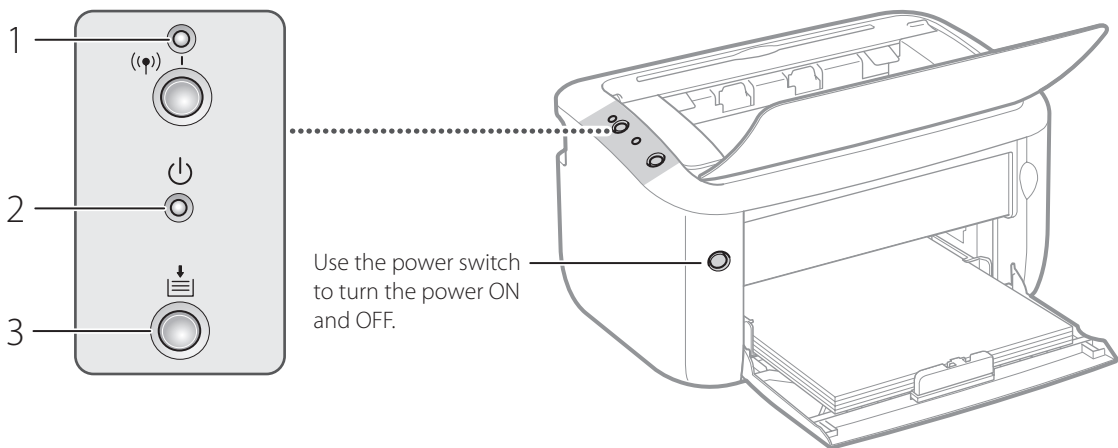

1 (Wi-Fi) indicator LBP6030w

Fr Témoin (Wi-Fi)

De Anzeige (Wi-Fi)

It Indicatore (Wi-Fi)

Es Indicador (Wi-Fi)

Da Indikatoren (Wi-Fi)

Nl (Wi-Fi) indicatielampje

No (Wi-Fi)-indikator

Sv (Wi-Fi)-indikator

Fi (Wi-Fi)-merkkivalo

Ru индикатор (Wi-Fi)

Pl Wskaźnik (Wi-Fi)

Tr (Wi-Fi) göstergesi

Ar (Wi-Fi) مؤشر

2 (Power) indicator

Fr Témoin (Marche/Arrêt)

De Anzeige (Ein/Aus)

It Indicatore (Power)

Es Indicador (Alimentación)

Da Indikatoren (Strøm)

Nl (Stroom) indicatielampje

No (Strøm)-indikator

Sv (Ström)-indikator

Fi (Virta)-merkkivalo

Ru индикатор (Power) (Питание)

Pl Wskaźnik (Zasilanie)

Tr (Güç) göstergesi

Ar مؤشر (الطاقة)

3 (Paper) indicator / key

Fr Témoin / Touche (Papier)

De Anzeige / Taste (Papier)

It Indicatore / Tasto (Carta)

Es Indicador / Tecla (Papel)

Da Indikatoren / Tasten (Papir)

Nl (Papier) indicatielampje / toets

No (Papir)-indikator / tast

Sv (Papper)-indikator / knapp

Fi (Paperi) -merkkivalo / näppäin

Ru индикатор/клавиша (Paper) (Бумага)

Pl Wskaźnik / klawisz (Papier)

Tr (Kağıt) göstergesi / tuşu

Ar مؤشر / مفتاح (الورق)

Check!

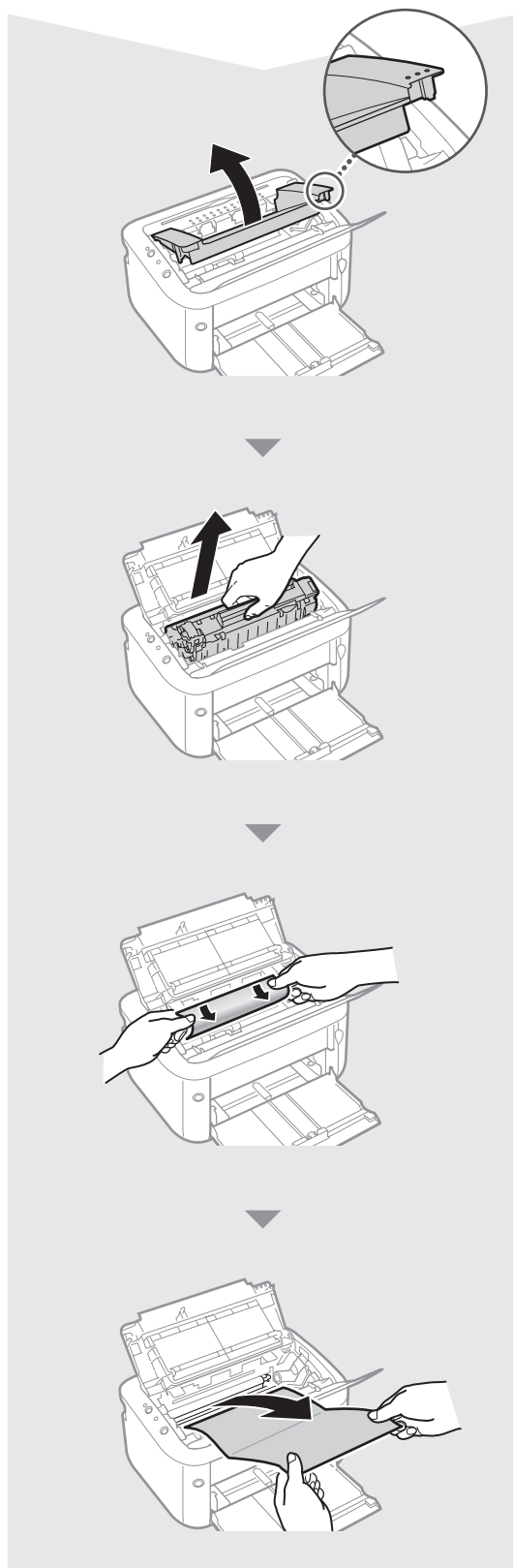
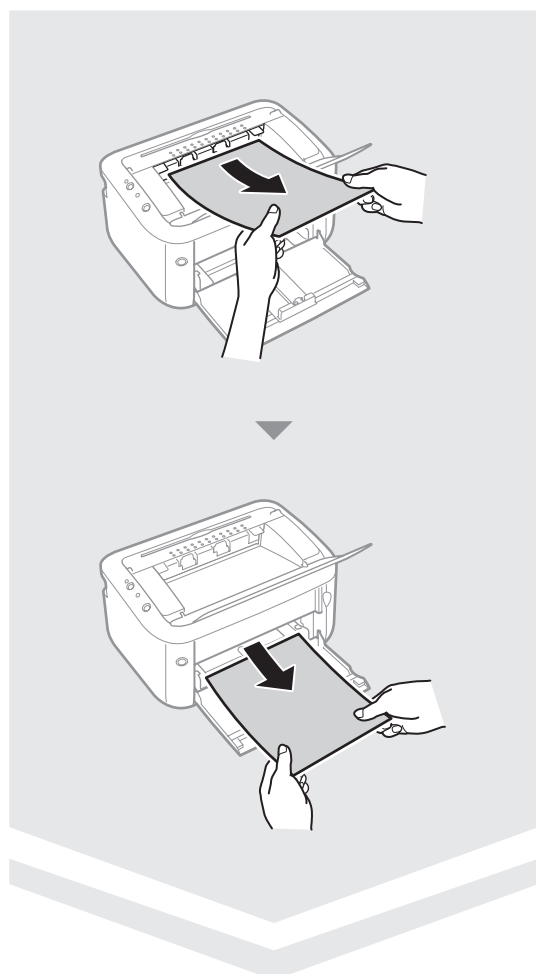
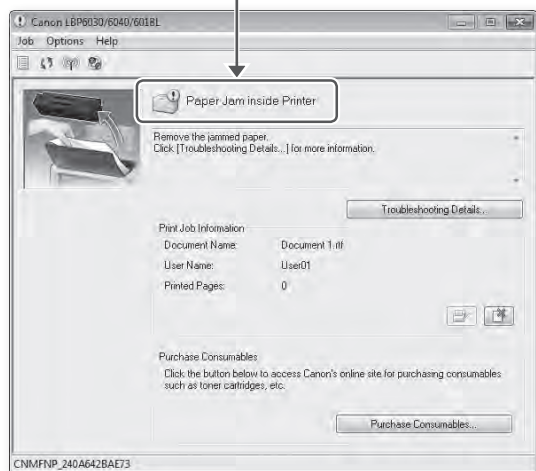

Loading Paper

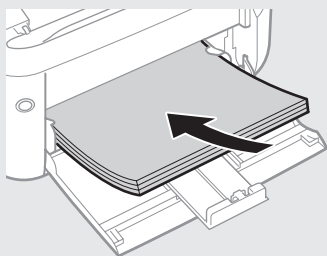
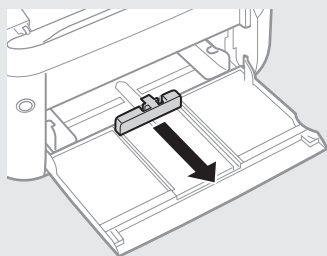
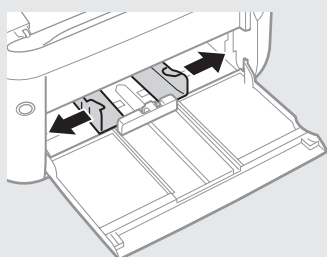
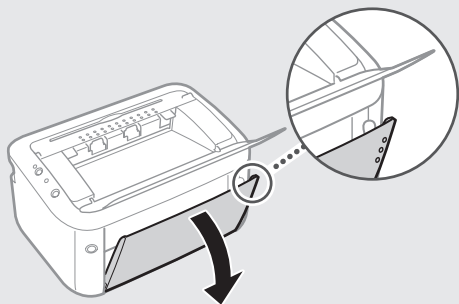

Keep the paper stack within the load limit guides.

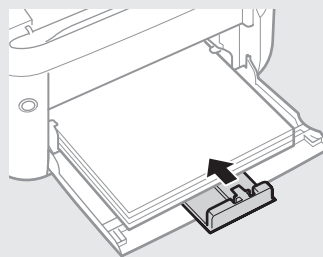
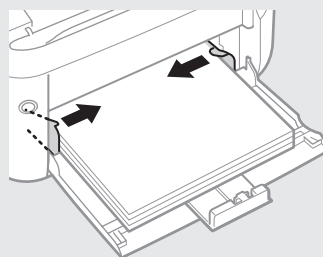
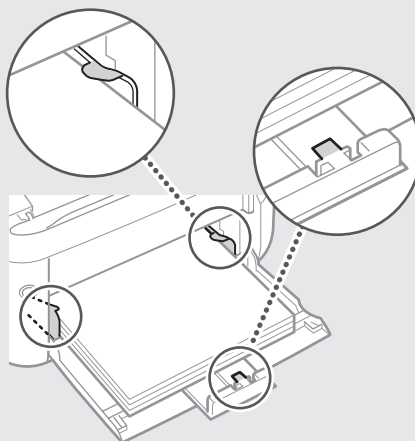

Replacing the Toner Cartridge

Canon Cartridge 725

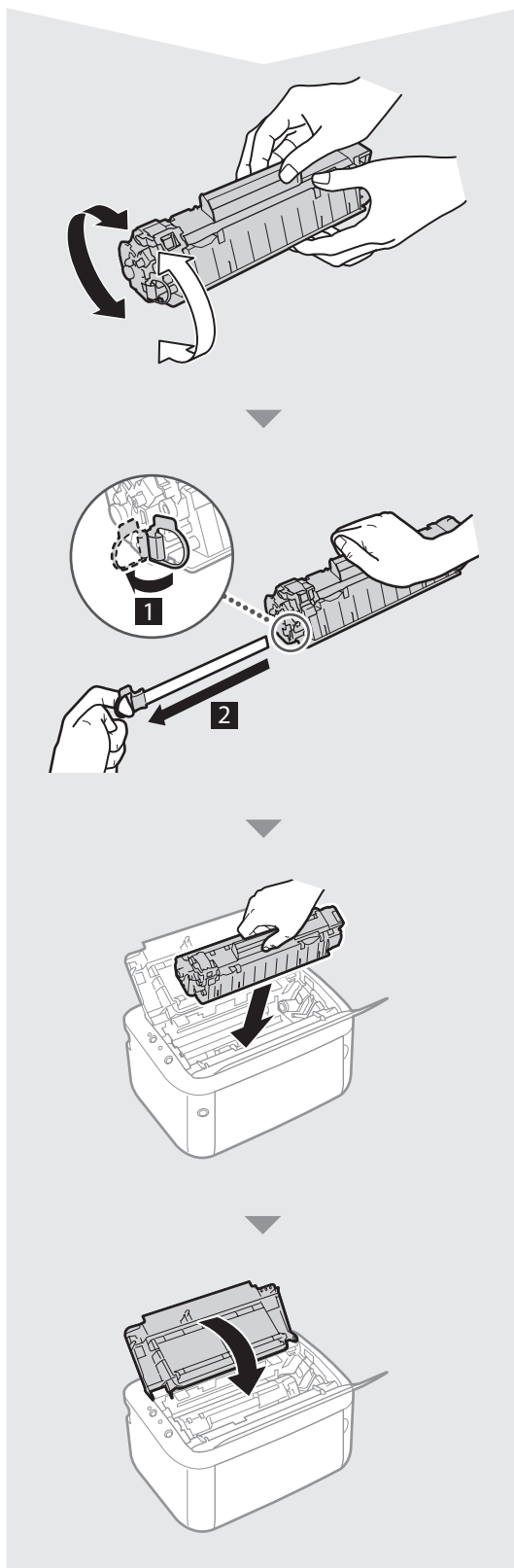
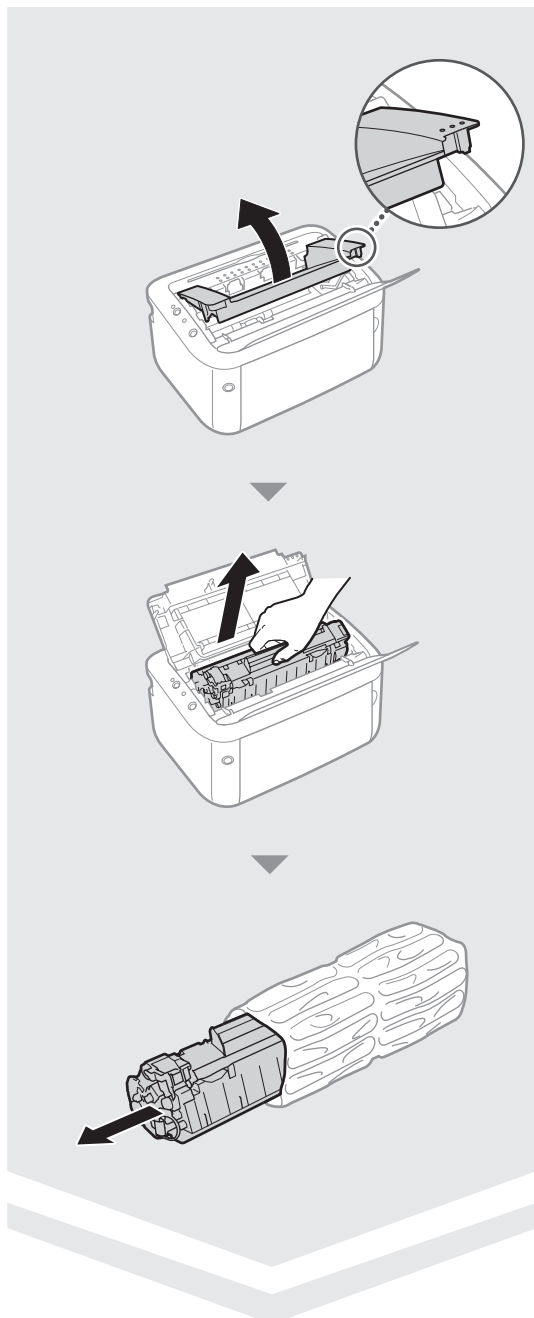
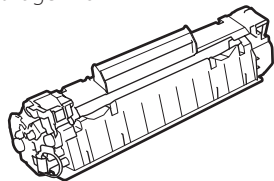

Cleaning the Inside of the Printer

Load Letter/A4 size paper

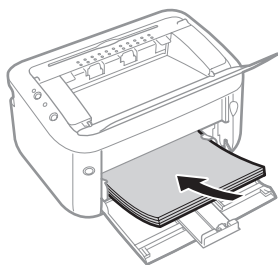

1 Click!

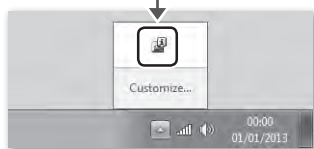

2 Click!

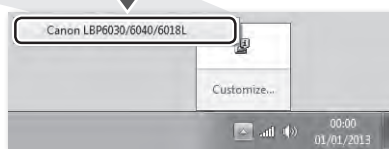

3 Select

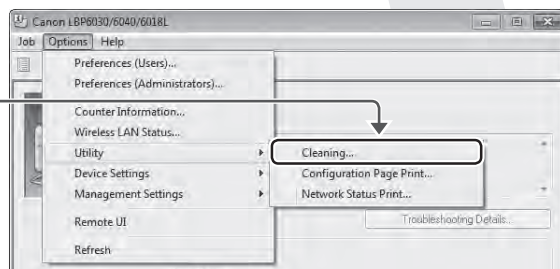

4 Click!

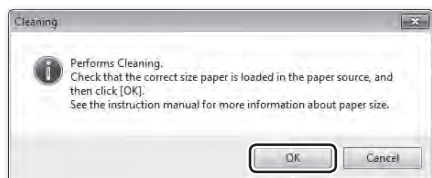

A Is the machine turned ON?

Fr L'appareil est-il sous tension ?

De Ist das Gerät eingeschaltet?

It La macchina è accesa?

Es ¿Está encendido el equipo?

Da Er maskinen tændt?

Nl Is de machine ingeschakeld?

No Er maskinen slått PÅ?

Sv Är maskinen på?

Fi Onko laite päällä?

Ru Включен ли аппарат?

Pl Czy urządzenie jest włączone?

Tr Makine açık mı?

Ar هل الجهاز قيد التشغيل؟

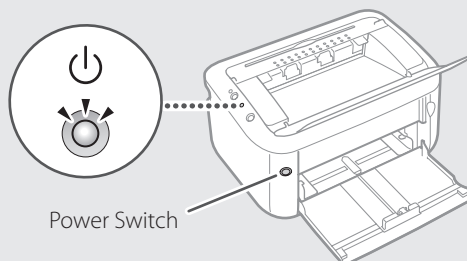

B Is the power cord connected?

Fr Le cordon d'alimentation est-il connecté ?

De Ist das Netzkabel angeschlossen?

It Il cavo di alimentazione è collegato?

Es ¿Está conectado el cable de alimentación?

Da Er netledningen tilsluttet?

Nl Is het netsnoer aangesloten?

No Er strømledningen tilkoblet?

Sv Är nätkabeln ansluten?

Fi Onko virtajohto kytketty?

Ru Подключен ли шнур питания?

Pl Czy przewód zasilania jest podłączony?

Tr Güç kablosu bağlı mı?

Ar هل تم توصيل سلك الكهرباء؟

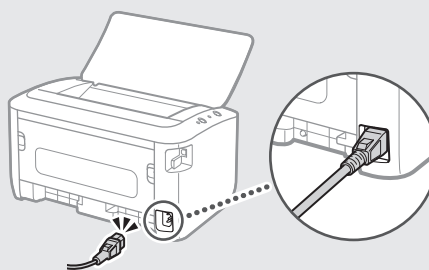

If the problem cannot be resolved, see the e-Manual (HTML manual).

Fr Si le problème ne peut pas être résolu, consultez le manuel électronique (manuel HTML).

De Lässt sich das Problem nicht beheben, ziehen Sie die e-Anleitung (HTML-Anleitung) zu Rate.

It Se non è possibile risolvere il problema, vedere l'e-Manual (manuale HTML).

Es Si el problema no puede solucionarse, consulte el e-Manual (manual HTML).

Da Hvis problemet ikke kan løses, henvises til e-manualen (HTML-manualen).

Nl Zie de e-Handleiding (HTML-handleiding) als het probleem niet kan worden opgelost.

No Hvis problemet ikke kan løses, se e-håndboken (HTML-håndboken).

C**Does the Printer Status Window display an error message?**

If a problem occurs, a message is displayed in the window.

Fr La Fenêtre d'état de l'imprimante affiche-t-elle un message d'erreur ?

Si un problème survient, un message s'affiche dans la fenêtre.

De Wird im Druckerstatusfenster eine Fehlermeldung angezeigt?

Wenn ein Problem auftritt, erscheint eine Meldung im Fenster.

It La Finestra stato stampante visualizza un messaggio di errore?

Se si verifica un problema, viene visualizzato un messaggio nella finestra.

Es ¿Muestra la Ventana de estado de la impresora un mensaje de error?

Si ocurre algún problema, aparecerá un mensaje en la ventana.

Da Viser printerstatusvinduet en fejlmeddelelse?

Hvis der opstår et problem, vises en meddelelse i vinduet.

Nl Geeft het printerstatusvenster een foutmelding weer?

Als er sprake is van een probleem, wordt er een bericht weergegeven in het venster.

No Viser skriverstatusvinduet en feilmelding?

Hvis det oppstår et problem, vises en melding i vinduet.

Sv Finns det något felmeddelande i skrivarstatusfönstret?

Ett meddelande visas i fönstret om det finns något fel.

Fi Näkykö tulostimen tilaikkunassa virheilmoitus?

Ongelmatilanteessa ikkunassa näytetään ilmoitus.

Ru Отображается ли в окне состояния принтера сообщение об ошибке?

При возникновении проблемы в окне отображается сообщение.

Pl Czy w oknie stanu drukarki wyświetlany jest komunikat o błędzie?

W przypadku wystąpienia problemu w oknie wyświetlany jest odpowiedni komunikat.

Tr Yazıcı Durumu Penceresi'nde bir hata mesajı görünüyor mu?

Sorun çıktığı zaman pencerede bir mesaj görüntülenir.

Ar هل تم توصيل سلك الكهرباء؟

في حالة حدوث مشكلة، يتم عرض رسالة في النافذة.

Sv Mer information finns i e-handboken (HTML-handbok) om felet inte kan lösas.**Fi** Jos ongelmaa ei voi ratkaista, katso sähköinen opas (HTML-opas).**Ru** Если проблему невозможно устранить, см. Электронное руководство (в формате HTML).**Pl** Jeżeli problemu nie można rozwiązać, należy zapoznać się z „e-Podręcznikiem” (podręcznik w formacie HTML).**Tr** Sorun çözülmezse e-Kılavuz'a (HTML kılavuz) bakın.**Ar** في حالة تعذر حل المشكلة، راجع الدليل الإلكتروني (دليل بتنسيق HTML).

This manual describes only warnings and cautions for the installation and the power supply. Be sure to read "Important Safety Instructions" described in the e-Manual (HTML manual) included in the supplied CD-ROM/DVD-ROM also.

WARNING

Indicates a warning concerning operations that may lead to death or injury to persons if not performed correctly. To use the machine safely, always pay attention to these warnings.

CAUTION

Indicates a caution concerning operations that may lead to injury to persons if not performed correctly. To use the machine safely, always pay attention to these cautions.

Installation

WARNING

Do not install in a location that may result in a fire or electrical shock

- A location where the ventilation slots are blocked (too close to walls, beds, sofas, rugs, or similar objects)
- A damp or dusty location
- A location exposed to direct sunlight or outdoors
- A location subject to high temperatures
- A location exposed to open flames
- Near alcohol, paint thinners or other flammable substances

Other warnings

- Do not connect unapproved cables to this machine. Doing so may result in a fire or electrical shock.
- Do not place necklaces and other metal objects or containers filled with liquid on the machine. If foreign substances come in contact with electrical parts inside the machine, it may result in a fire or electrical shock.
- Do not use near medical equipment. Radio waves emitted from this machine may interfere with medical equipment, which may result in malfunctions and accidents.
- If any foreign substance falls into this machine, unplug the power plug from the AC power outlet and contact your local authorized Canon dealer.

CAUTION

Do not install in the following locations

The machine may drop or fall, resulting in injury.

- An unstable location
- A location exposed to vibrations

Other warnings

- When carrying this machine, follow the instructions in this manual. If carried improperly, it may fall, resulting in injury.
- When installing this machine, be careful not to get your hands caught between the machine and the floor or walls. Doing so may result in injury.

Power Supply

WARNING

- Use only a power supply that meets the specified voltage requirements. Failure to do so may result in a fire or electrical shock.
- Do not use power cords other than the one provided, as this may result in a fire or electrical shock.
- Do not modify, pull, forcibly bend, or perform any other act that may damage the power cord. Do not place heavy objects on the power cord. Damaging the power cord may result in a fire or electrical shock.
- Do not plug in or unplug the power plug with wet hands, as this may result in an electrical shock.
- Do not use extension cords or multi-plug power strips with the machine. Doing so may result in a fire or electrical shock.
- Do not wrap the power cord or tie it in a knot, as this may result in a fire or electrical shock.
- Insert the power plug completely into the AC power outlet. Failure to do so may result in a fire or electrical shock.
- Remove the power plug completely from the AC power outlet during a thunder storm. Failure to do so may result in a fire, electrical shock, or damage to the machine.

CAUTION

Do not obstruct the power outlet where this machine is connected, so that you can unplug the power plug easily in an emergency.

Before Using the Printer

To avoid the risk of personal injury or damage to the printer, and for legal information, make sure to read the "Legal Notices" and "Important Safety Instructions" in the e-Manual included on the accompanying CD-ROM/DVD-ROM carefully before using the printer.

Fr Avant d'utiliser l'imprimante

Pour éviter de vous blesser ou d'endommager l'imprimante, et pour consulter les informations légales, veillez à bien consulter les rubriques "Publication judiciaire" et "Consignes de sécurité importantes" du manuel électronique fourni sur le CD-ROM/DVD-ROM qui accompagne le produit, avant toute utilisation de l'imprimante.

De Bevor Sie den Drucker verwenden

Lesen Sie vor der Verwendung des Druckers auf der beiliegenden CD-ROM/DVD-ROM in der e-Anleitung die Abschnitte "Rechtshinweise" und "Wichtige Sicherheitsvorschriften", um Verletzungen oder Beschädigungen des Druckers zu vermeiden und rechtliche Informationen zu erhalten.

It Prima di utilizzare la stampante

Per evitare il rischio di infortunio o di danni alla stampante, nonché per informazioni di carattere legale, leggere attentamente le sezioni "Avvertenze legali" e "Istruzioni importanti per la sicurezza" dell'e-Manual contenuto nel CD-ROM/DVD-ROM prima di installare la stampante.

Es Antes de utilizar la impresora

Para evitar el riesgo de sufrir lesiones personales o de causar daños a la impresora (y para información legal), asegúrese de leer atentamente los "Avisos legales" y las "Instrucciones de seguridad importantes" del e-Manual incluido en el CD-ROM/DVD-ROM suministrado antes de utilizar la impresora.

Da Før printeren tages i brug

For at undgå risiko for personskade eller beskadigelse af printeren og for at få juridiske oplysninger bør du inden brug af printeren omhyggeligt læse "Juridiske bemærkninger" og "Vigtige sikkerhedsinstruktioner" i den e-manual, der findes på den medfølgende cd-rom/dvd-rom.

NI Voordat u de printer gebruikt

Ter voorkoming van het risico van persoonlijk letsel of beschadiging van de printer en ter kennisneming van de wettelijke informatie is het belangrijk dat u, voordat u de printer in gebruik neemt, de "Juridische kennisgevingen" en de "Belangrijke veiligheidsvoorschriften" aandachtig leest, die staan in de e-Handleiding op de begeleidende CD-ROM/DVD-ROM.

No Før bruk av skriveren

Hvis du vil unngå fare for personskade og skade på skriveren, og få juridisk informasjon, må du lese nøye gjennom "Juridiske merknader" og "Viktige sikkerhetsinstruksjoner" i e-Manual som ligger på CD-ROM-en/DVD-ROM-en som følger med, før du begynner å bruke skriveren.

Sv Innan du använder skrivaren

För att undvika risker för personskador eller skador på skrivaren och för juridisk information se till att läsa "Juridiska meddelanden" och "Viktig säkerhetsinformation" i e-handboken som finns på den medföljande CD-ROM-/DVD-ROM-skivan noggrant innan du använder skrivaren.

Fi Ennen tulostimen käyttämistä

Jotta vältät henkilövahinkojen tai tulostimen vaurioitumisen riskin ja jos haluat lisätietoja lakiasioista, varmista ennen tulostimen käyttöä, että luet "Lakitiedot" ja "Tärkeitä turvaohjeita" sähköisestä oppaasta, joka löytyy toimitukseen kuuluvalla CD-ROM/DVD-ROM-levyltä.

Ru Перед использованием принтера

Во избежание травм и повреждения принтера, а также для получения юридической информации внимательно прочтите разделы "Правовые вопросы" и "Важные указания по технике безопасности" Электронного руководства, находящегося на CD-/DVD-диске из комплекта поставки, перед началом использования принтера.

Pl Przed rozpoczęciem korzystania z drukarki

Aby zminimalizować ryzyko obrażeń ciała i uszkodzenia drukarki oraz zapoznać się z informacjami prawnymi, należy przed rozpoczęciem korzystania z drukarki przeczytać rozdział „Uwagi prawne” oraz „Ważne instrukcje dotyczące bezpieczeństwa” w e-Podręczniku umieszczonym na dysku CD-ROM/DVD-ROM dołączonym do drukarki.

Tr Yazıcıyı Kullanmadan Önce

Yaralanma veya yazıcının hasar görmesi riskini önlemek ve yasal bilgileri edinmek için, yazıcıyı kullanmadan önce, beraberinde verilen CD-ROM/DVD-ROM'daki e-Kılavuz'da bulunan "Yasal Uyarılar" ve "Önemli Güvenlik Talimatları" kısımlarını mutlaka dikkatle okuyun.

Ar

قبل استخدام الطابعة

تفادي مخاطر الإصابة أو إلحاق الضرر بالطابعة، وللتعرف على المعلومات القانونية، يجب قراءة "الإشعارات القانونية" و"تعليمات الأمان المهمة" بعناية والمتاحة على الدليل الإلكتروني الموجود على القرص المدمج/ قرص DVD قبل الشروع في استخدام الطابعة.



CANON INC.

30-2, Shimomaruko 3-chome, Ohta-ku, Tokyo 146-8501, Japan

CANON MARKETING JAPAN INC.

16-6, Konan 2-chome, Minato-ku, Tokyo 108-8011, Japan

CANON U.S.A., INC.

One Canon Park, Melville, NY 11747, U.S.A.

CANON EUROPA N.V.

Bovenkerkerweg 59, 1185 XB Amstelveen, The Netherlands

CANON CHINA CO. LTD.

15F Jinbao Building No.89, Jinbao Street, Dongcheng District, Beijing 100005, PRC

CANON SINGAPORE PTE LTD

1 HarbourFront Avenue, #04-01 Keppel Bay Tower, Singapore 098632

CANON AUSTRALIA PTY LTD

1 Thomas Holt Drive, North Ryde, Sydney NSW 2113, Australia

CANON GLOBAL WORLDWIDE SITES

<http://www.canon.com/>

Printed on non-chlorine bleached paper.
Gedruckt auf chlorfrei gebleichtem Papier.



FT6-0754-000

FT6-0754 (000) XXXXXXXXXX Copyright CANON INC. 2014 PRINTED IN VIETNAM



<https://tm.by>
Интернет-магазин