

Model No.DTD172 CORDLESS IMPACT DRIVER

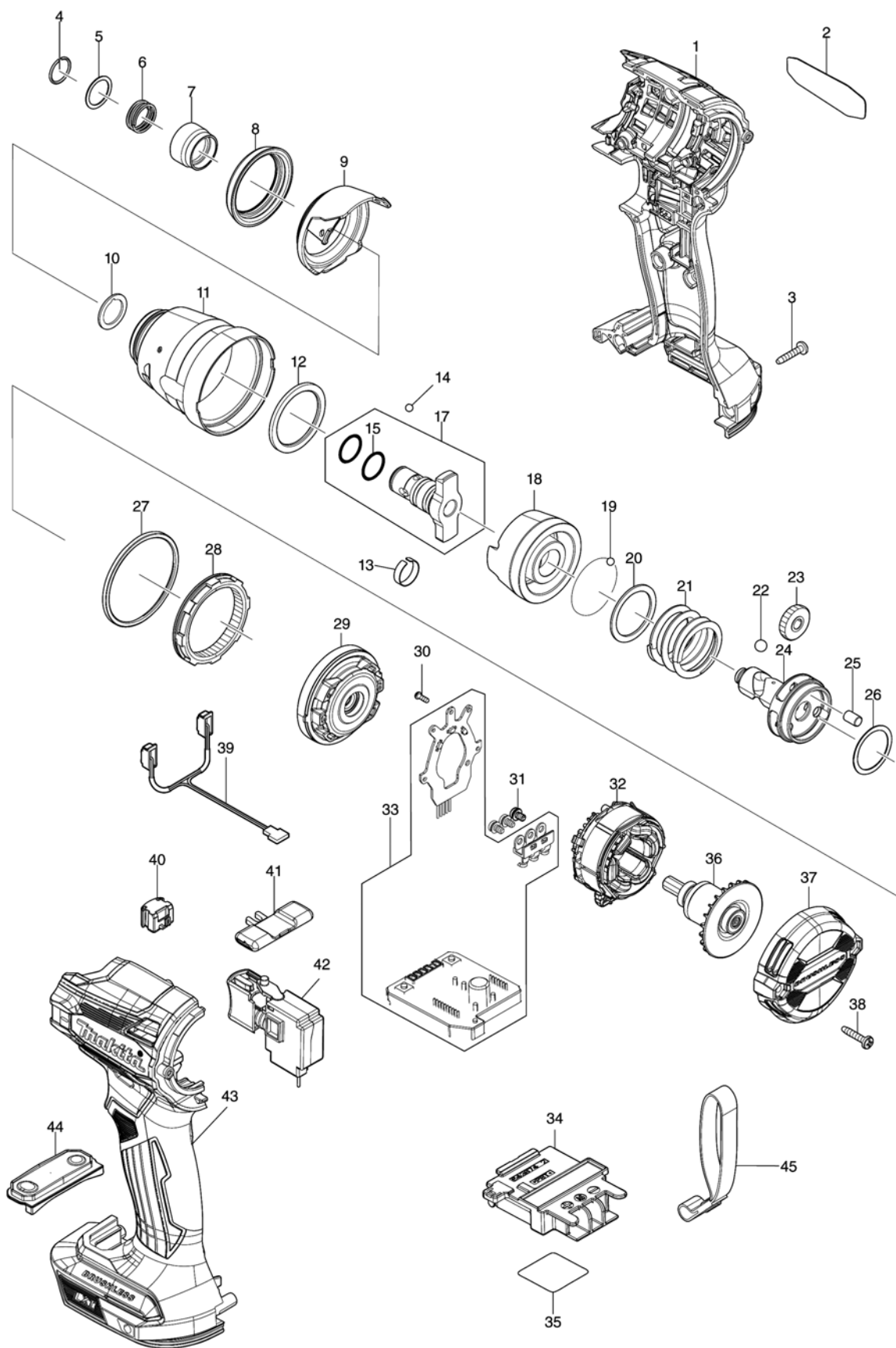

Model No.DTD172 CORDLESS IMPACT DRIVER

Item	Parts No.	Description	I/C	Qty	New/Old	Opt. 1	Opt. 2	Note
001	183S40-8	HOUSING SET		1				
C10	263005-3	RUBBER PIN 6		2				
C20	252126-6	HEX. LOCK NUT M4-7		2				
D10		INC. 43						
002	8111E5-4	DTD172 NAME PLATE		1				
003	266429-2	TAPPING SCREW 3X16		7				
004	231952-6	RING SPRING 12		1				
005	267101-9	FLAT WASHER 14		1				
006	232592-3	COMPRESSION SPRING 14		1				
007	327883-6	BIT SLEEVE		1				
008	422689-8	BUMPER		1				
009	413493-6	HAMMER CASE COVER		1				
011	141A40-6	HAMMER CASE COMPLETE		1				
012	261168-9	NYLON WASHER 29		1				
014	216040-0	STEEL BALL 3.5		2				
015	213166-9	O RING 12.5		2				
017	136562-3	ANVIL M ASSY		1				
D10		INC. 15						
018	327785-6	HAMMER		1				
019	216040-0	STEEL BALL 3.5		24				
020	267175-0	FLAT WASHER 24		1				
021	232459-5	COMPRESSION SPRING 24B		1				
022	216011-7	STEEL BALL 5.6		2				
023	227350-0	SPUR GEAR 22		3				
024	327784-8	SPINDLE		1				
025	268311-1	PIN 5		3				
026	267283-7	FLAT WASHER 21		1				
027	422688-0	SEAL		1				
028	227882-7	INTERNAL GEAR 51		1				
029	141A41-4	BEARING BOX COMPLETE		1				
030	266490-9	TAPPING SCREW PT 2X6		3				
031	652069-6	FLAT HEAD SCREW M3X6		3				
032	629217-2	STATOR		1				
033	620E81-4	CONTROLLER		1				
034	643874-2	TERMINAL		1				
035	8111F2-7	DTD172 SERIAL NO. LABEL		1				
036	619678-4	ROTOR		1				
037	413494-4	REAR COVER		1				
038	266429-2	TAPPING SCREW 3X16		2				
039	620F12-9	LED CIRCUIT		1				
040	632L84-8	SWITCH UNIT		1				
041	455053-8	F/R CHANGE LEVER		1				

Please order the parts with part number.

Print Date 1/10/2021

Model No.DTD172 CORDLESS IMPACT DRIVER

Item	Parts No.	Description	I/C	Qty	New/Old	Opt. 1	Opt. 2	Note
042	651442-7	SWITCH C3JR-1A-1		1				
043	183S40-8	HOUSING SET		1				
C10	263005-3	RUBBER PIN 6		2				
C20	252126-6	HEX. LOCK NUT M4-7		2				
D10		INC. 1						
044	141F68-4	SWITCH PLATE COMPLETE		1				
A01	266622-8	+ TRUSS HEAD SCREW M4X12		1				
A02	346317-0	HOOK		1				
A04B	821550-0	CONNECTOR PLASTIC CASE (TYPE2)		1				
C10	453974-8	LATCH		4				
A05B	837670-0	INNER TRAY		1				
A06B	8042M5-3	DTD172RTJ PLASTIC CASE LABEL		2				
A07B	8042M4-5	DTD172RTJ INDICATION LABEL		1				
A08B	450128-8	BATTERY COVER		1				
A09B	***DC18RC	DC18RC FAST CHARGER		1				
D10		COMPO-PARTS						
A10B	197280-8	BATTERY BL1850B SET		2				

Please order the parts with part number.

Print Date 1/10/2021