

ALPHA1 L

Installation and operating instructions



be
think
innovate

GRUNDFOS 

English (GB) Installation and operating instructions

Original installation and operating instructions

These installation and operating instructions describe Grundfos ALPHA1 L.

Sections 1-4 give the information necessary to be able to unpack, install and start up the product in a safe way.

Sections 5-11 give important information about the product, as well as information on service, fault finding and disposal of the product.

CONTENTS

	Page
1. General information	2
1.1 Hazard statements	2
1.2 Notes	2
2. Receiving the product	3
2.1 Inspecting the product	3
2.2 Scope of delivery	3
3. Installing the product	3
3.1 Mechanical installation	3
3.2 Pump positions	3
3.3 Control box positions	4
3.4 Insulating the pump housing	4
3.5 Electrical connection	5
3.6 Assembling the installer plug	5
4. Starting up the product	6
4.1 Before startup	6
4.2 Starting up the pump	6
4.3 Venting the pump	7
5. Product introduction	7
5.1 Product description	7
5.2 Applications	7
5.3 Pumped liquids	7
5.4 Identification	8
5.5 Accessories	9
5.6 Power supply	10
6. Control functions	11
6.1 Operating panel	11
6.2 Control modes	11
6.3 Pump performance	13
7. Setting the product	14
7.1 Setting the PWM input signal	15
8. Servicing the product	15
8.1 Dismantling the product	15
8.2 Dismantling the plug	15
9. Fault finding the product	16
9.1 Deblocking the shaft	17
10. Technical data	18
10.1 Dimensions, ALPHA1 L XX-40, XX-60, 15-65	19
10.2 Dimensions, ALPHA1 L 25-65	20
10.3 Curve conditions	20
10.4 Performance curves, ALPHA1 L XX-40 (N)	21
10.5 Performance curves, ALPHA1 L XX-60 (N)	22
10.6 Performance curves, ALPHA1 L XX-65 (N)	23
11. Disposing of the product	23



Read this document and the quick guide before you install the product. Installation and operation must comply with local regulations and accepted codes of good practice.

This appliance can be used by children aged from 8 years and above and persons with reduced physical, sensory or mental capabilities or lack of experience and knowledge if they have been given supervision or instruction concerning use of the appliance in a safe way and understand the hazards involved.

Children shall not play with the appliance. Cleaning and user maintenance shall not be made by children without supervision.



1. General information

1.1 Hazard statements

The symbols and hazard statements below may appear in Grundfos installation and operating instructions, safety instructions and service instructions.



DANGER

Indicates a hazardous situation which, if not avoided, will result in death or serious personal injury.



WARNING

Indicates a hazardous situation which, if not avoided, could result in death or serious personal injury.



CAUTION

Indicates a hazardous situation which, if not avoided, could result in minor or moderate personal injury.

The text accompanying the three hazard symbols DANGER, WARNING and CAUTION is structured in the following way:

SIGNAL WORD

Description of hazard

Consequence of ignoring the warning.
- Action to avoid the hazard.



The hazard statements are structured in the following way:

1.2 Notes

The symbols and notes below may appear in Grundfos installation and operating instructions, safety instructions and service instructions.



Observe these instructions for explosion-proof products.



A blue or grey circle with a white graphical symbol indicates that an action must be taken.



A red or grey circle with a diagonal bar, possibly with a black graphical symbol, indicates that an action must not be taken or must be stopped.



If these instructions are not observed, it may result in malfunction or damage to the equipment.



Tips and advice that make the work easier.

2. Receiving the product

2.1 Inspecting the product

Check that the product received is in accordance with the order.
Check that the voltage and frequency of the product match voltage and frequency of the installation site. See section [5.4.1 Nameplate](#).

2.2 Scope of delivery

The box contains the following items:

- ALPHA1 L pump
- installer plug
- two gaskets
- quick guide.

3. Installing the product

3.1 Mechanical installation

3.1.1 Mounting the product

1. The arrows on the pump housing indicate the flow direction through the pump. See fig. 1.
2. Fit the two gaskets supplied with the pump when you mount the pump in the pipe. Install the pump with a horizontal motor shaft. See fig. 2. See also section [3.3 Control box positions](#).
3. Tighten the fittings. See fig. 3.

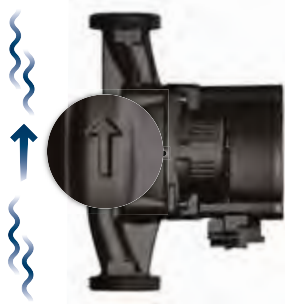

Fig. 1 Flow direction

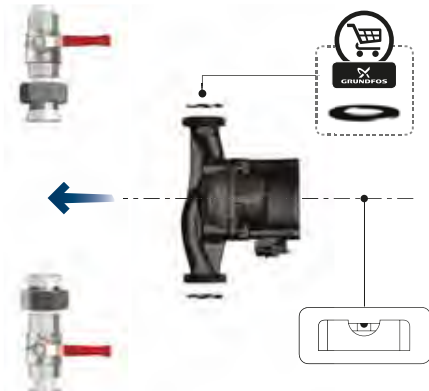

Fig. 2 Pump installation

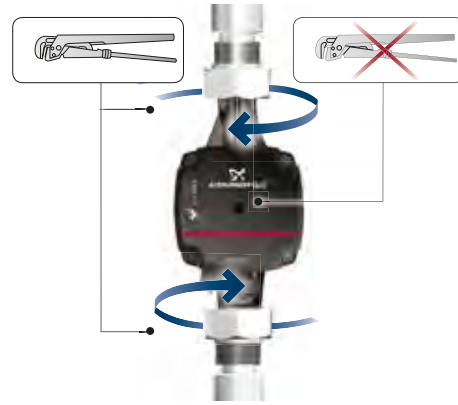

Fig. 3 Tightening the fittings

3.2 Pump positions

Always install the pump with a horizontal motor shaft. Do not install the pump with a vertical motor shaft. See fig. 4, bottom row.

- Pump installed correctly in a vertical pipe. See fig. 4, top row, left.
- Pump installed correctly in a horizontal pipe. See fig. 4, top row, right.



Fig. 4 Pump positions

TM06 8535 0918

TM06 8536 0918

TM06 8537 0918

TM06 8538 0918

3.3 Control box positions

DANGER

Electric shock



Death or serious personal injury
 - Switch off the power supply before starting any work on the product. Make sure that the power supply cannot be accidentally switched on.

CAUTION

Hot surface



Minor or moderate personal injury
 - The pump housing may be hot due to the pumped liquid being scalding hot. Close the isolating valves on both sides of the pump and wait for the pump housing to cool down.

CAUTION

Pressurised system



Minor or moderate personal injury
 - Before dismantling the pump, drain the system or close the isolating valves on both sides of the pump. The pumped liquid may be scalding hot and under high pressure.

The control box can be mounted in all positions. See fig. 5.

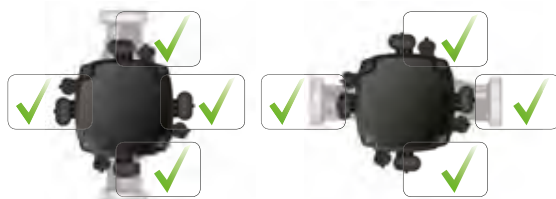

Fig. 5 Possible control box positions

TM06 7297 0918

3.3.1 Changing the control box position

Step	Action	Illustration
1	Make sure that the inlet and outlet valves are closed. Unscrew the screws on the pump head.	TM06 8539 0918
2	Turn the pump head to the desired position.	TM06 8540 0918
3	Refit the screws on the pump head.	TM06 8541 0918

3.4 Insulating the pump housing



TM06 8564 1317

Fig. 6 Insulating the pump housing

You can reduce the heat loss from the pump and pipe by insulating the pump housing and the pipe with insulating shells, which can be ordered as an accessory. See section [5.5.2 Insulating shells](#).



Do not insulate the control box or cover the operating panel.

3.5 Electrical connection

DANGER

Electric shock

Death or serious personal injury

- All electrical connections must be carried out by a qualified electrician in accordance with local regulations.



DANGER

Electric shock

Death or serious personal injury

- Switch off the power supply before starting any work on the product. Make sure that the power supply cannot be accidentally switched on.



DANGER

Electric shock

Death or serious personal injury

- Connect the pump to earth.
- Connect the pump to an external main switch with a minimum contact gap of 3 mm in all poles.



DANGER

Electric shock

Death or serious personal injury

- If national legislation requires a Residual-Current Device (RCD) or equivalent in the electrical installation, or if the pump is connected to an electric installation where an RCD is used as an additional protection, this must be type A or better, due to the nature of the pulsating DC leakage current. The RCD must be marked with the symbol shown below:



- The motor requires no external motor protection.
- Check that the supply voltage and frequency correspond to the values stated on the nameplate. See section [5.4.1 Nameplate](#).
- Connect the pump to the power supply with the plug supplied with the pump. See steps 1 to 7.

3.6 Assembling the installer plug

Step	Action	Illustration
1	Loosen the cable gland and unscrew the union nut in the centre of the terminal cover.	
2	Detach the terminal cover.	
3	Pull the power cable through the cable gland and terminal cover.	
4	Strip the cable conductors as illustrated.	
5	Loosen the screws on the power supply plug and connect the cable conductors.	
6	Tighten the screws on the power supply plug.	

Step	Action	Illustration
7	<p>Refit the terminal cover. See A.</p> <p>Note: It is possible to turn the power supply plug on the side for a 90° cable entry. See B.</p>	
8	Tighten the union nut.	
9	Tighten the cable gland onto the power supply plug.	
10	<p>Insert the power supply plug into the male plug on the pump.</p>	

TM06 8549 0918 - TM06 8550 0918

TM06 8551 0918

TM06 8552 0918

TM06 8553 0918

4. Starting up the product

4.1 Before startup

Do not start the pump until the system has been filled with liquid and vented. Make sure that the required minimum inlet pressure is available at the pump inlet. See section 10. *Technical data*.

When using the pump for the first time, the system must be vented at the highest point. See section 4.3 *Venting the pump*. The pump is self-venting through the system.

4.2 Starting up the pump

Step	Action	Illustration
1	Open the inlet and outlet valves.	
2	Switch on the power supply.	
3	<p>The lights in the operating panel indicates that the power supply has been switched on and the pump is running.</p>	

TM06 8554 0918

TM06 8555 1317

TM06 8556 0918

4.3 Venting the pump

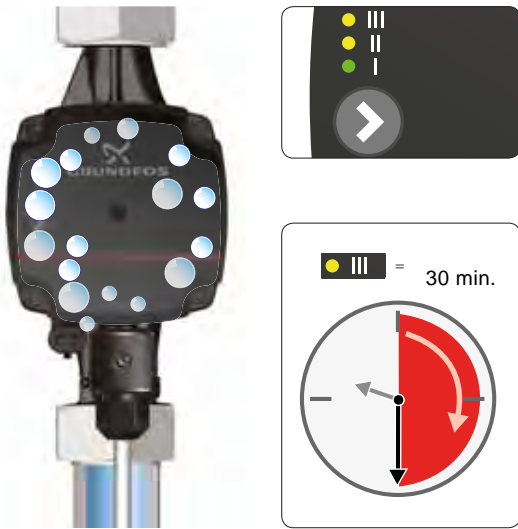

Fig. 7 Venting the pump

Small air pockets trapped inside the pump may cause noise when starting up the pump. However, because the pump is self-venting through the system, the noise ceases over a period of time.

To speed up the venting process, do as follows:

1. Set the pump to speed III using the push-button on the operating panel.
2. Let the pump run for approximately 30 minutes. How fast the pump is vented depends on the system size and design.

When you have vented the pump, that is when the noise has ceased, set the pump according to the recommendations. See section 6. [Control functions](#).



The pump must not run dry.



The pump is from factory set to radiator heating mode.

TM07 0153 0918

5. Product introduction

5.1 Product description

ALPHA1 L can be used as stand-alone or integrated circulator pump in existing systems as replacement or in new systems with either variable or constant flow rate.

5.1.1 Model type

These installation and operating instructions cover ALPHA1 L. The model type is stated on the packaging and nameplate.

5.2 Applications

ALPHA1 L is designed for circulating liquids in all kinds of heating applications. The pumps are suitable for the following systems:

- Systems with constant or variable flows where it is desirable to optimise the pump duty point.
- Installation in existing systems where the differential pressure of the pump is too high during periods of reduced flow demand.
- Installation in new systems for automatic adjustment of the performance to flow demands without the use of bypass valves or similar expensive components.

The speed can be controlled by a low-voltage PWM (Pulse Width Modulation) signal.

High-efficiency ECM (Electronically Commutated Motor) pumps, such as ALPHA1 L, must not be speed-controlled by an external speed controller varying or pulsing the supply voltage.

The speed can be controlled by a low-voltage PWM (Pulse Width Modulation) signal.

5.3 Pumped liquids

In heating systems, the water must meet the requirements of accepted standards on water quality in heating systems, for example the German guideline VDI 2035.

The pump is suitable for clean, thin, non-aggressive and non-explosive liquids, not containing solid particles, fibres or mineral oil.

- Maximum water/propylene glycol mixture is 50 %
- Maximum 10 mm²/s viscosity

Note: The water/propylene glycol mixture reduces the performance due to higher viscosity.

See section 10. [Technical data](#) for further information.



In domestic hot-water systems, we recommend that you keep the liquid temperature below 65 °C to eliminate the risk of lime precipitation.

CAUTION

Flammable material



Minor or moderate personal injury

- Do not use the pump for flammable liquids, such as diesel oil and petrol.

CAUTION

Corrosive substance



Minor or moderate personal injury

- Do not use the pump for aggressive liquids, such as acids and seawater.

5.4 Identification

5.4.1 Nameplate

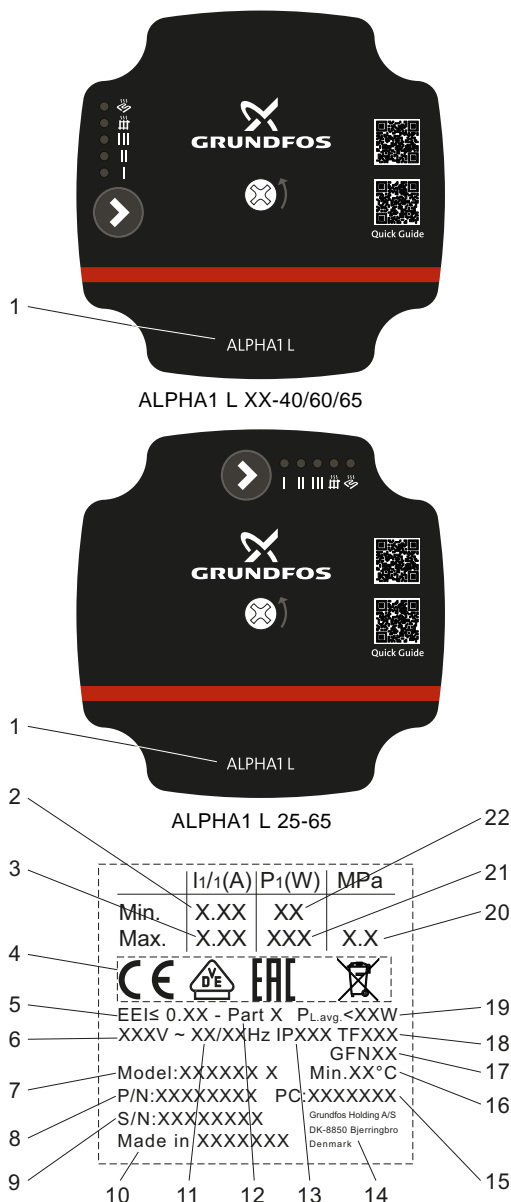

Fig. 8 Nameplate

Pos.	Description
1	Pump name
2	Minimum current [A]
3	Maximum current [A]
4	CE mark and approvals
5	Energy Efficiency Index, EEI
6	Voltage [V]
7	Product type
8	Material number
9	Serial number
10	Country of manufacture
11	Frequency [Hz]
12	Part, according to EEI
13	Enclosure class
14	Manufacturer's name and address
15	Production code, year and week
16	Minimum liquid temperature
17	VDE code
18	TF class
19	Average compensated power input PL, avg [W]
20	Maximum system pressure
21	Maximum input power [W]
22	Minimum input power [W]

5.4.2 Type key

Example	ALPHA1 L	25	-40	180
Pump type				
Nominal diameter (DN) of inlet and outlet ports [mm]				
Maximum head [dm]				
[]: Cast-iron pump housing				
N: Stainless-steel pump housing				
Port-to-port length [mm]				

TM06 8664 1717

5.5 Accessories

5.5.1 Unions and valve kits

		Product numbers, unions														
ALPHAX	Connection	Rp			R		Rp			mm		mm				
		3/4	1	1 1/4	1	1 1/4	3/4	1	1 1/4	Ø22	Ø28	Ø15	Ø18	Ø22	Ø28	Ø42
25-xx	G 1 1/2	529921	529922	529821	529925	529924										
25-xx N	G 2	529971	529972				519805	519806	519807	519808	519809		529977	529978	529979	
32-xx	G 2		509921	509922												

G-threads have a cylindrical form in accordance with the EN ISO 228-1 standard and are not sealing the thread. It requires a flat gasket. You can only screw cylindrical male G-threads, into female G-threads. The G-threads are standard thread on the pump housing.

R-threads are tapered external threads in accordance with the EN z0226-1 standard.

Rc- or Rp-threads are internal threads with either tapered or cylindrical threads. You can screw conical male R-threads into female Rc- or Rp-threads. See fig. 9.

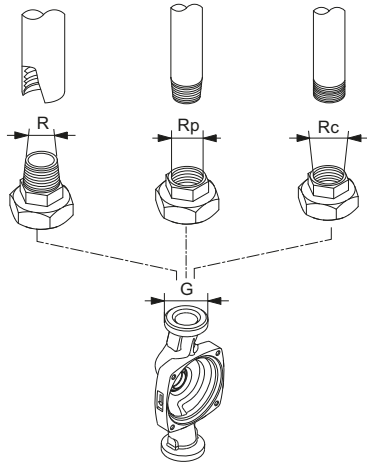

TM06 7632 3616

Fig. 9 G-threads and R-threads

5.5.2 Insulating shells

The insulating shells, which are tailored to the individual pump type, can be ordered as accessories. It is easy to fit the insulating shells around the pump.

Pump type	Product number
ALPHA1 L XX-XX (N)	99270706

5.5.3 Control box connections

The ALPHA1 L control box has two electrical connections on one side: the power supply and the control signal connection.

5.6 Power supply

The installer plug is supplied with the pump and is available as an accessory.

Power cable adapters are also available as accessories.

5.6.1 Control signal connection

The control signal cable connection has three conductors: the signal input, the signal output and the signal reference. Connect the cable to the control box by a mini superseal plug. See fig. 11. The optional signal cable can be supplied with the circulator as an accessory.

The PWM signal connection is covered by a blind plug from the factory. See fig. 10.



Fig. 10 Control signal connection







Fig. 11 Mini superseal plug

TM06 7633 0918

TM06 58210216

5.6.2 Cables and plugs

Picture	Product description	Length [mm]	Product number
	Installer plug		99439948
	Signal cable with mini superseal	2000	99165309
	Superseal Molex cable adapter, overmoulded	150	99165311
	Superseal Volex cable adapter, overmoulded	150	99165312

6. Control functions

6.1 Operating panel



Fig. 12 Operating panel

Symbol	Description
	Push-button
I, II, III	Constant curve or constant speed curve I, II and III
	Radiator heating mode (proportional pressure)
	Underfloor heating mode (constant pressure)

The operating panel shows the following:

- The control mode, after pressing the button
- Alarm status

6.1.1 Alarm or warning

If the pump has detected one or more alarms or warnings, the first LED switches from green to red. When the fault has been resolved the operating panel switches back to operating status. See section [9. Fault finding the product](#).

6.2 Control modes

The pump has seven different control modes. Learn more about them in the following sections.

6.2.1 Radiator heating mode (factory setting)

The radiator heating mode adjusts the pumps performance to the actual heat demand in the system following a proportional-pressure curve.

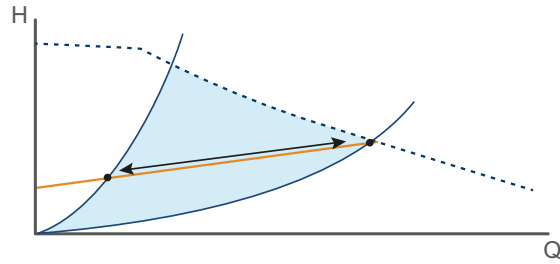

Fig. 13 Proportional-pressure curve

System type	Recommended control mode	Alternative control mode
Two-pipe system	Radiator heating mode	Constant curve or constant speed I, II, III, see section 6.2.3 Constant curve or constant speed, I, II or III

6.2.2 Underfloor heating mode

The underfloor heating mode adjusts the pumps performance to the actual heat demand in the system following a constant-pressure curve.

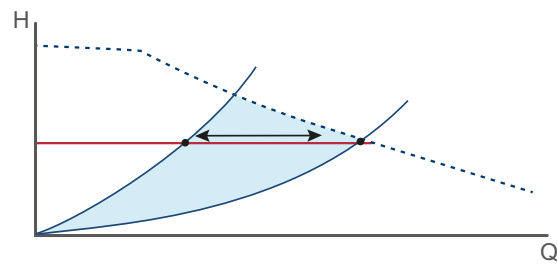

Fig. 14 Constant-pressure curve

System type	Recommended control mode	Alternative control mode
Underfloor heating system	Underfloor heating mode	No alternatives

TM06 8815 1217

TM06 8816 1217

6.2.3 Constant curve or constant speed, I, II or III

At constant-curve or constant-speed operation, the pump runs at a constant curve. The pump performance follows the selected performance curve, I, II or III. See fig. 15 where II has been selected.

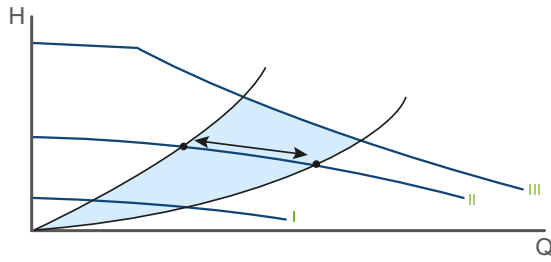

Fig. 15 Constant-curve/speed curve

The selection of the constant-curve or constant-speed setting depends on the characteristics of the heating system in question.

6.2.4 Pump setting for one-pipe heating systems

Recommended and alternative pump settings:

System type	Recommended control mode	Alternative control mode
One-pipe heating system	Constant curve or constant speed, I, II or III. See section 6.2.3 <i>Constant curve or constant speed, I, II or III.</i>	No alternatives

6.2.5 Pump setting for domestic hot-water systems

Recommended and alternative pump settings:

System type	Recommended control mode	Alternative control mode
Domestic hot-water system	Constant curve or constant speed, I, II or III. See section 6.2.3 <i>Constant curve or constant speed, I, II or III.</i>	No alternatives

6.2.6 Changing from recommended to alternative pump setting

Heating systems are relatively slow systems that cannot be set to the optimum operation within minutes or hours.

If the recommended pump setting does not give the desired distribution of heat in the rooms of the house, change the pump setting to the shown alternative.

6.2.7 Externally controlled signal connection: PWM input signal profile A (heating)

ALPHA1 L can be controlled via a digital low-voltage pulse-width modulation (PWM) signal. For instructions on how to set the connection, see section 7.1 *Setting the PWM input signal.*

The circulator runs on constant-speed curves depending on the PWM input signal. The speed decreases when the PWM value increases. If PWM equals 0, the circulator runs at maximum speed.

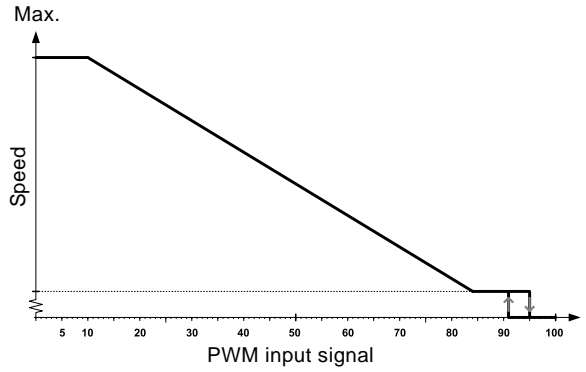

Fig. 16 PWM input signal profile A (heating)

PWM input signal [%]	Pump status
≤ 10	Maximum speed: max.
> 10 / ≤ 84	Variable speed: min. to max.
> 84 / ≤ 91	Minimum speed: IN
> 91/95	Hysteresis area: on/off
> 95 or ≤ 100	Standby mode: off

6.2.8 PWM feedback signal - power consumption

The PWM feedback signal offers pump information like in bus systems:

- current power consumption (accuracy ± 2 % of PWM signal)
- warning
- alarm
- operation status.

6.2.9 Alarms

Alarm output signals are available because some PWM output signals are dedicated to alarm information. If a supply voltage is measured below the specified supply voltage range, the output signal is set to 75 %. If the rotor is locked due to deposits in the hydraulics, the output signal is set to 90 % because this alarm has a higher priority. See fig. 17.

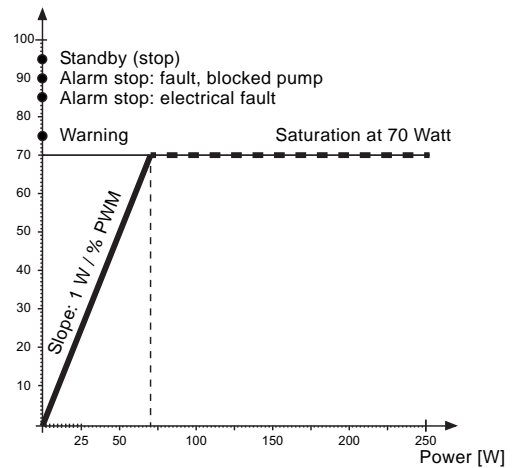

Fig. 17 PWM feedback signal - power consumption

6.3 Pump performance

Figure 18 shows the relation between pump setting and pump performance by means of curves.

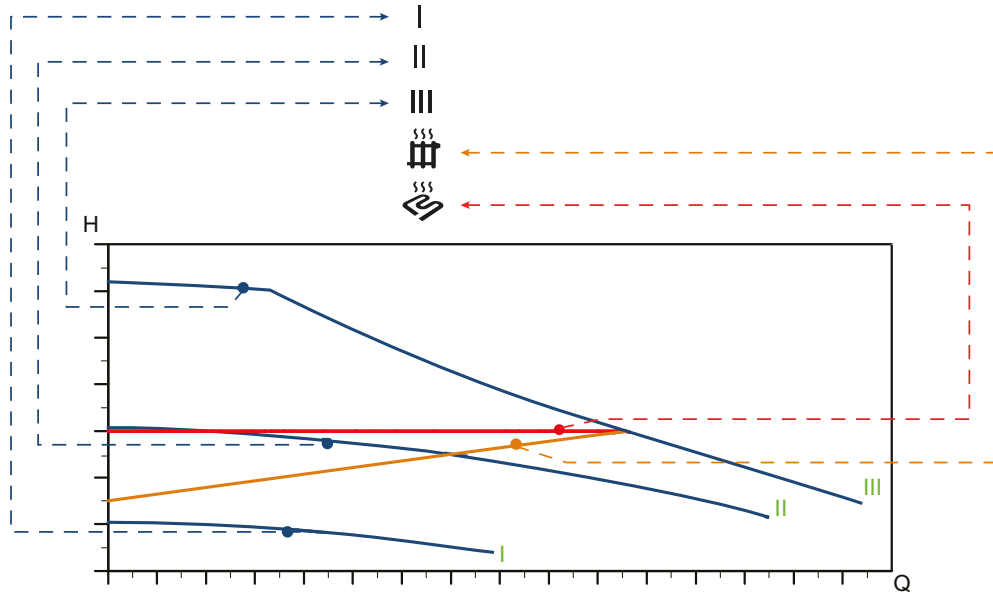



Fig. 18 Pump setting in relation to pump performance

TM06 8818 1217

Setting	Pump curve	Function
I	Constant curve or constant speed I	The pump runs at a constant speed and consequently on a constant curve. At speed I, the pump is set to run on the minimum curve under all operating conditions.
II	Constant curve or constant speed II	The pump runs at a constant speed and consequently on a constant curve. At speed II, the pump is set to run on the intermediate curve under all operating conditions.
III	Constant curve or constant speed III	The pump runs at a constant speed and consequently on a constant curve. At speed III, the pump is set to run on the maximum curve under all operating conditions. Quick venting of the pump can be obtained by setting the pump to speed III for a short period.
	Radiator heating mode (proportional-pressure curve)	The duty point of the pump will move up or down on a proportional-pressure curve, depending on the heat demand in the system. The head (pressure) is reduced at falling heat demand and increased at rising heat demand.
	Underfloor heating mode (constant-pressure curve)	The duty point of the pump will move out or in on a constant-pressure curve, depending on the heat demand in the system. The head (pressure) is kept constant, irrespective of the heat demand.

7. Setting the product

To set the product use the push-button on the operating panel. Every time you press the push-button, the pump setting is changed. The LEDs will indicate the chosen control mode. See fig. 19. A cycle is five button presses.

The pump automatically enables the PWM input-signal control mode when the signal cable is plugged in and the PWM signal is detected by the pump. For details on setting the PWM input signal, see section [7.1 Setting the PWM input signal](#).

To select the fixed proportional-pressure curve, press and hold the push-button for 3 seconds. To disable this control mode, press and hold the button for 3 seconds.

To learn more about each control mode, see section [6.2 Control modes](#)

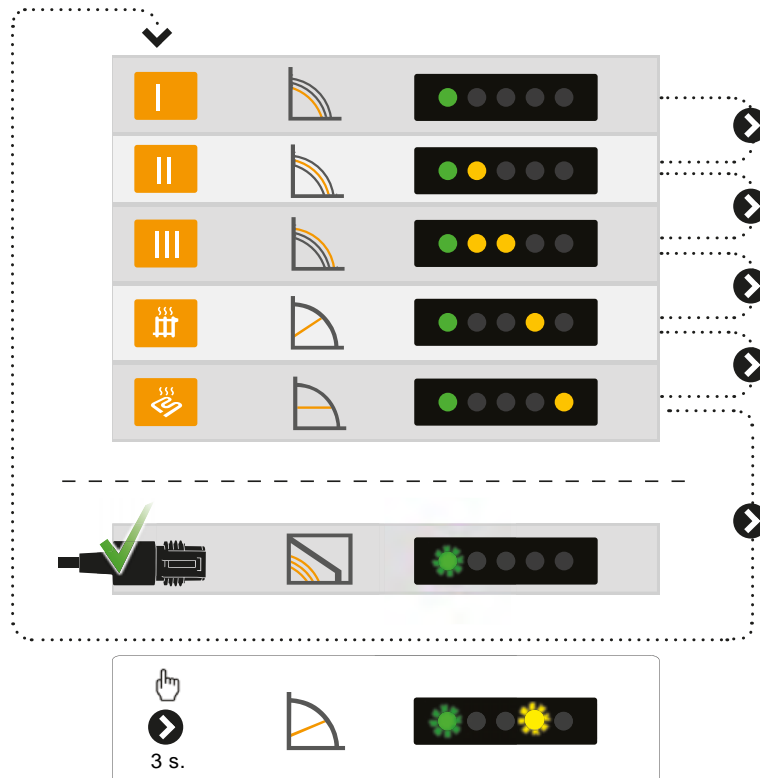

Fig. 19 Operating panel LEDs indicating the different control modes



The pump has been factory-set to radiator heating mode.

7.1 Setting the PWM input signal

To enable the external control mode (PWM profile A), you need a signal cable connected to an external system. The cable connection has three conductors: the signal input, the signal output and the signal reference.

The cable is not supplied with the pump but can be ordered as an accessory.



The cable must be connected to the control box via a mini superseal plug. See fig. 20.



TM06 5821 0216

Fig. 20 Mini superseal plug

Set the signal connection

1. Make sure that the pump is turned off.
2. The PWM signal connection is covered by a blind plug. Remove the plug.
3. Connect the signal cable with the mini superseal plug.
4. Switch on the power supply.
5. The pump automatically detects if a valid PWM signal is available after which it enables the control mode on the pump. See fig. 21.



TM06 7633 0918

Fig. 21 Connecting the signal cable to the ALPHA1 L

8. Servicing the product

DANGER

Electric shock



Death or serious personal injury

- All electrical connections must be carried out by a qualified electrician in accordance with local regulations.

DANGER

Electric shock



Death or serious personal injury

- Switch off the power supply before starting any work on the product. Make sure that the power supply cannot be accidentally switched on.

CAUTION

Hot surface



Minor or moderate personal injury

- The pump housing may be hot due to the pumped liquid being scalding hot. Close the isolating valves on both sides of the pump and wait for the pump housing to cool down.

CAUTION

Pressurised system



Minor or moderate personal injury

- Before dismantling the pump, drain the system or close the isolating valves on both sides of the pump. The pumped liquid may be scalding hot and under high pressure.

8.1 Dismantling the product

1. Switch off the power supply.
2. Pull out the plug. For instructions on how to dismantle the plug, see section [8.2 Dismantling the plug](#).
3. Close the two isolating valves on both sides of the pump.
4. Loosen the fittings.
5. Remove the pump from the system.

8.2 Dismantling the plug

1. Loosen the cable gland and unscrew the union nut in the centre of the terminal cover.
2. Detach the terminal cover.
3. Loosen the screws on the power supply plug and disconnect the cable conductors.
4. Pull the power cable back through the cable gland and terminal cover.

9. Fault finding the product

If the pump has detected one or more alarms, the first LED switches from green to red. When an alarm is active, the LEDs indicate the alarm type as defined in fig. 22.



If multiple alarms are active at the same time, the LEDs only show the error with the highest priority. The priority is defined by the sequence of the table.

When there is no active alarm anymore, the operating panel switches back to operating status and the first LED switches from red to green.



DANGER
Electric shock

Death or serious personal injury
- Switch off the power supply before starting any work on the product. Make sure that the power supply cannot be accidentally switched on.



CAUTION
Hot surface

Minor or moderate personal injury
- The pump housing may be hot due to the pumped liquid being scalding hot. Close the isolating valves on both sides of the pump and wait for the pump housing to cool down.



CAUTION
Pressurised system

Minor or moderate personal injury
- Before dismantling the pump, drain the system or close the isolating valves on both sides of the pump. The pumped liquid may be scalding hot and under high pressure.

Status	Fault	Display	Solution
Alarm The pump stops. The pump is blocked.			Deblock the shaft. See section 9.1 Deblocking the shaft .
Warning The pump keeps running. The supply voltage is low.			Make sure that there is sufficient voltage supply to the pump.
Alarm The pump stops. Electrical error.			Replace the pump and send the pump to the nearest Grundfos Service Center.

Fig. 22 Fault finding table

9.1 Deblocking the shaft

If the pump is blocked it is necessary to deblock the shaft. The ALPHA1 L deblocking device is accessible from the front of the circulator without having to demount the control box. The force of the device is high enough to deblock circulators, which are seized by lime, e.g. if the pump has been turned off during summer.

Course of action:

1. Switch off the power supply.
2. Locate the deblocking screw in the centre of the control box.
3. Use a star screwdriver with a size 2 Phillips tip to push the deblocking screw inwards.
4. When the screw can be turned counterclockwise, the shaft has been deblocked. Repeat step 3, if necessary.
5. Switch on the power supply.

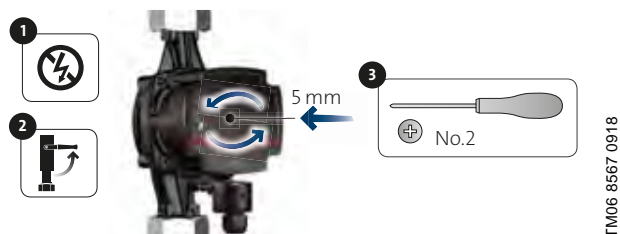

Fig. 23 Deblocking the shaft



Before, during and after the deblocking, the device is tight and must not release any water.

10. Technical data

Operating conditions		
Sound pressure level	The sound pressure level of the pump is lower than 43 dB(A).	
Relative humidity	Maximum 95 %, non-condensing environment	
System pressure	PN 10: Maximum 1.0 MPa (10 bar)	
	Liquid temperature	Minimum inlet pressure
Inlet pressure	75 °C	0.005 MPa (0.05 bar), 0.5 m head
	95 °C	0.05 MPa (0.5 bar), 5 m head
Ambient temperature	0-55 °C	
Liquid temperature	2-95 °C	
Liquid	Maximum water/propylene glycol mixture is 50 %	
Viscosity	Maximum 10 mm ² /s	
Minimum switching time power on/off	No specific requirements.	
Maximum altitude of installation	2000 m above sea level	
Electrical data		
Supply voltage	1 x 230 V - 15 %/+ 10 %, 50/60 Hz, PE	
Insulation class	F	
Standby power consumption	< 0.3 W	
Miscellaneous data		
Motor protection	The pump requires no external motor protection.	
Enclosure class	IPX4D	
Temperature class (TF)	TF95	
Specific EEI values	ALPHA1 L XX-40: EEI ≤ 0.20	
	ALPHA1 L XX-60: EEI ≤ 0.20	
	ALPHA1 L XX-65: EEI ≤ 0.20	

To avoid condensation in the stator, the liquid temperature must always be higher than the ambient temperature.



In domestic hot-water systems, we recommend that you keep the liquid temperature below 65 °C to eliminate the risk of lime precipitation.

10.1 Dimensions, ALPHA1 L XX-40, XX-60, 15-65

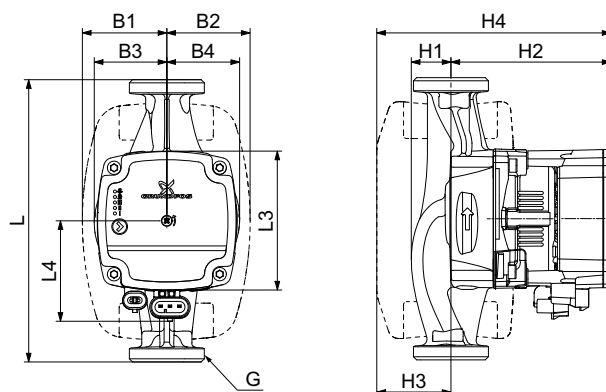

Fig. 24 ALPHA1 L XX-40, XX-60, 15-65

TM07 1242 1218

Pump type	Dimensions [mm]											
	L	L3	L4	B1	B2	B3	B4	H1	H2	H3	H4	G
ALPHA1 L 15-40	130	88	64	54	54	46	47	25	102	47	149	G 1
ALPHA1 L 15-60	130	88	64	54	54	46	47	25	102	47	149	G 1
ALPHA1 L 15-65	130	88	64	54	54	46	47	25	102	47	149	G 1
ALPHA1 L 20-40	130	88	64	54	54	46	47	25	102	47	149	G 1 1/4
ALPHA1 L 20-40 N	150	90	64	54	54	49	49	27	102	47	149	G 1 1/4
ALPHA1 L 20-60	130	88	64	54	54	46	47	25	102	47	149	G 1 1/4
ALPHA1 L 20-60 N	150	90	64	54	54	49	49	27	102	47	149	G 1 1/4
ALPHA1 L 25-40	130	88	64	54	54	46	47	25	102	47	149	G 1 1/2
ALPHA1 L 25-40 N	180	88	64	54	54	46	46	25	102	47	149	G 1 1/2
ALPHA1 L 25-60	130	88	64	54	54	46	47	25	102	47	149	G 1 1/2
ALPHA1 L 25-60 N	180	88	64	54	54	46	46	25	102	47	149	G 1 1/2
ALPHA1 L 25-60 N	180	90	64	54	54	49	49	27	102	47	149	G 1 1/2
ALPHA1 L 32-40	180	88	64	54	54	46	48	26	102	47	149	G 2
ALPHA1 L 32-60	180	88	64	54	54	46	48	26	102	47	149	G 2

10.2 Dimensions, ALPHA1 L 25-65

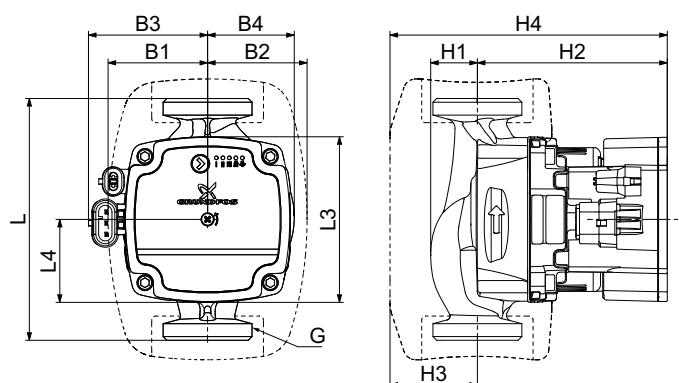

Fig. 25 ALPHA1 L 25-65

Pump type	Dimensions [mm]											
	L	L3	L4	B1	B2	B3	B4	H1	H2	H3	H4	G
ALPHA1 L 25-65	130	89	45	54	54	72	47	25	102	47	149	G 1 1/2

10.3 Curve conditions

The guidelines below apply to the performance curves on the following pages:

- Test liquid: airless water.
- The curves apply to a density of $\rho = 983.2 \text{ kg/m}^3$ and a liquid temperature of $60 \text{ }^\circ\text{C}$.
- All curves show average values and must not be used as guarantee curves. If a specific minimum performance is required, individual measurements must be made.
- The curves for speeds I, II and III are marked.
- The curves apply to a kinematic viscosity of $\nu = 0.474 \text{ mm}^2/\text{s}$ (0.474 cSt).
- The EEI values obtained according to EN 16297 part 3.

10.4 Performance curves, ALPHA1 L XX-40 (N)

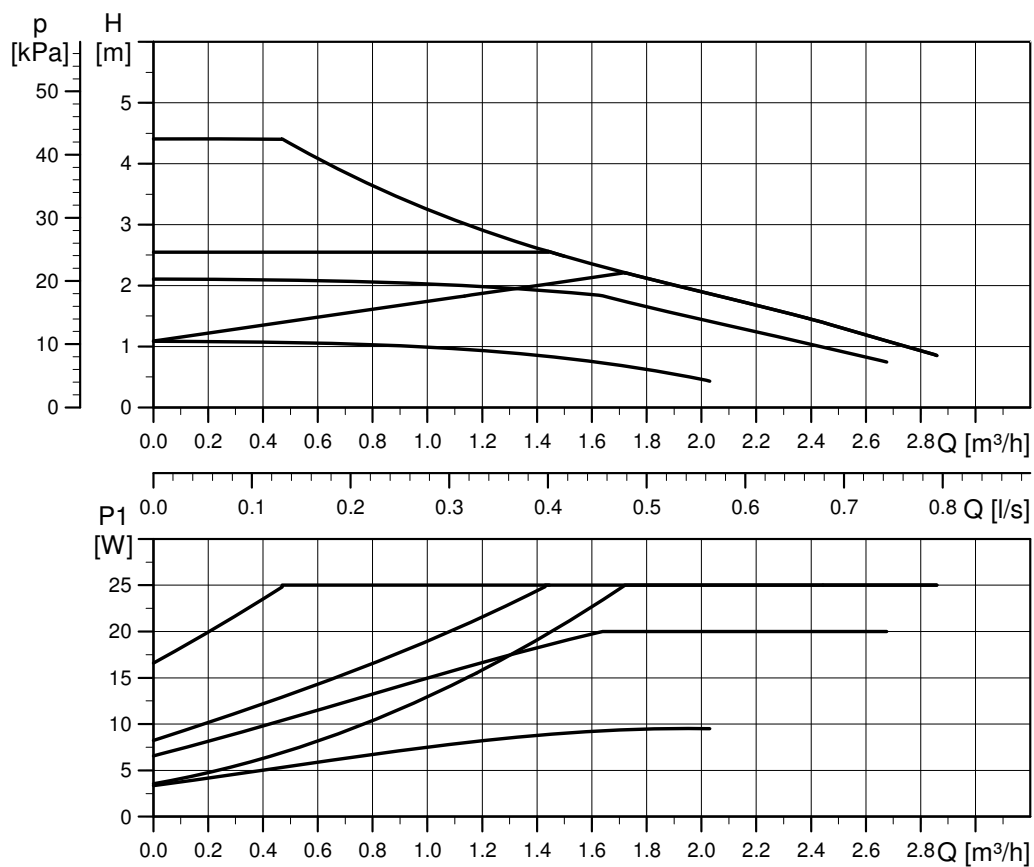

Fig. 26 ALPHA1 L XX-40

Setting	P1 [W]	I ₁ [A]
Min.	4	0.05
Max.	25	0.26

10.5 Performance curves, ALPHA1 L XX-60 (N)

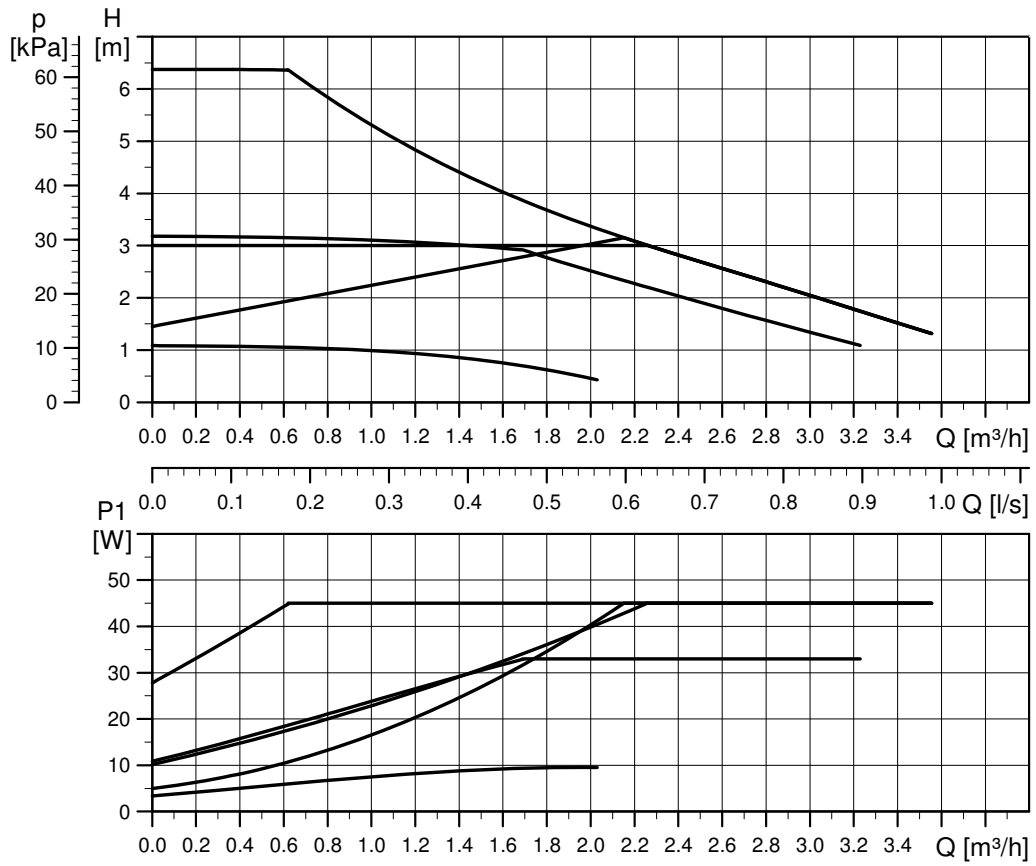

Fig. 27 ALPHA1 L XX-60

Setting	P1 [W]	I ₁ [A]
Min.	4	0.05
Max.	45	0.42

TM07 0798 1018

10.6 Performance curves, ALPHA1 L XX-65 (N)

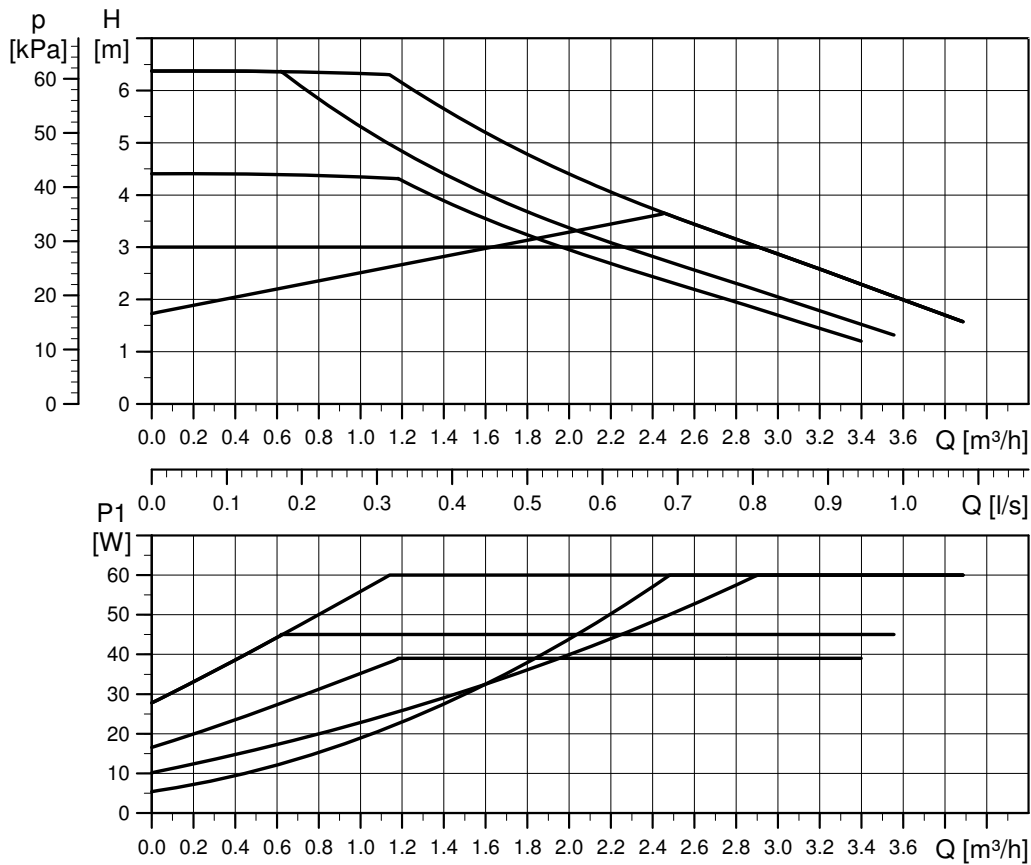

Fig. 28 ALPHA1 L XX-65

Setting	P1 [W]	I ₁ [A]
Min.	4	0.05
Max.	60	0.52

11. Disposing of the product

This product or parts of it must be disposed of in an environmentally sound way:

1. Use the public or private waste collection service.
2. If this is not possible, contact the nearest Grundfos company or service workshop.



The crossed-out wheellie bin symbol on a product means that it must be disposed of separately from household waste. When a product marked with this symbol reaches its end of life, take it to a collection point designated by the local waste disposal authorities. The separate collection and recycling of such products will help protect the environment and human health.

See also end-of-life information at www.grundfos.com/product-recycling.

TM07 0799 1018

Argentina

Bombas GRUNDFOS de Argentina S.A.
Ruta Panamericana km. 37.500 Centro
Industrial Garin
1619 Garin Pcia. de B.A.
Phone: +54-3327 414 444
Telefax: +54-3327 45 3190

Australia

GRUNDFOS Pumps Pty. Ltd.
P.O. Box 2040
Regency Park
South Australia 5942
Phone: +61-8-8461-4611
Telefax: +61-8-8340 0155

Austria

GRUNDFOS Pumpen Vertrieb Ges.m.b.H.
Grundfosstraße 2
A-5082 Grödig/Saltzburg
Tel.: +43-6246-883-0
Telefax: +43-6246-883-30

Belgium

N.V. GRUNDFOS Bellux S.A.
Boomssteenweg 81-83
B-2630 Aartselaar
Tél.: +32-3-870 7300
Télécopie: +32-3-870 7301

Belarus

Представительство ГРУНДФОС в
Минске
220125, Минск
ул. Шафарнянская, 11, оф. 5Б, БЦ
«Порт»
Тел.: +7 (375 17) 286 39 72/73
Факс: +7 (375 17) 286 39 71
E-mail: minsk@grundfos.com

Bosnia and Herzegovina

GRUNDFOS Sarajevo
Zmaja od Bosne 7-7A,
BH-71000 Sarajevo
Phone: +387 33 592 480
Telefax: +387 33 590 465
www.ba.grundfos.com
e-mail: grundfos@bih.net.ba

Brazil

BOMBAS GRUNDFOS DO BRASIL
Av. Humberto de Alencar Castelo Branco,
630
CEP 09850 - 300
São Bernardo do Campo - SP
Phone: +55-11 4393 5533
Telefax: +55-11 4343 5015

Bulgaria

Grundfos Bulgaria EOOD
Slatina District
Iztochna Tangenta street no. 100
BG - 1592 Sofia
Tel. +359 2 49 22 200
Fax. +359 2 49 22 201
email: bulgaria@grundfos.bg

Canada

GRUNDFOS Canada Inc.
2941 Brighton Road
Oakville, Ontario
L6H 6C9
Phone: +1-905 829 9533
Telefax: +1-905 829 9512

China

GRUNDFOS Pumps (Shanghai) Co. Ltd.
10F The Hub, No. 33 Suhong Road
Minhang District
Shanghai 201106
PRC
Phone: +86 21 612 252 22
Telefax: +86 21 612 253 33

COLOMBIA

GRUNDFOS Colombia S.A.S.
Km 1.5 vía Siberia-Cota Conj. Potrero
Chico,
Parque Empresarial Arcos de Cota Bod.
1A.
Cota, Cundinamarca
Phone: +57(1)-2913444
Telefax: +57(1)-8764586

Croatia

GRUNDFOS CROATIA d.o.o.
Buzinski prilaz 38, Buzin
HR-10010 Zagreb
Phone: +385 1 6595 400
Telefax: +385 1 6595 499
www.hr.grundfos.com

GRUNDFOS Sales Czechia and Slovakia s.r.o.

Čajkovského 21
779 00 Olomouc
Phone: +420-585-716 111

Denmark

GRUNDFOS DK A/S
Martin Bachs Vej 3
DK-8850 Bjerringbro
Tlf.: +45-87 50 50 50
Telefax: +45-87 50 51 51
E-mail: info_GDK@grundfos.com
www.grundfos.com/DK

Estonia

GRUNDFOS Pumps Eesti OÜ
Peterburi tee 92G
11415 Tallinn
Tel: +372 606 1690
Fax: +372 606 1691

Finland

OY GRUNDFOS Pumpat AB
Trukkikuja 1
FI-01360 Vantaa
Phone: +358-(0) 207 889 500

France

Pompes GRUNDFOS Distribution S.A.
Parc d'Activités de Chesnes
57, rue de Malacombe
F-38290 St. Quentin Fallavier (Lyon)
Tél.: +33-4 74 82 15 15
Télécopie: +33-4 74 94 10 51

Germany

GRUNDFOS GMBH
Schlüterstr. 33
40699 Erkrath
Tel.: +49-(0) 211 929 69-0
Telefax: +49-(0) 211 929 69-3799
e-mail: infoservice@grundfos.de
Service in Deutschland:
e-mail: kundendienst@grundfos.de

Greece

GRUNDFOS Hellas A.E.B.E.
20th km. Athinon-Markopoulou Av.
P.O. Box 71
GR-19002 Peania
Phone: +0030-210-66 83 400
Telefax: +0030-210-66 46 273

Hong Kong

GRUNDFOS Pumps (Hong Kong) Ltd.
Unit 1, Ground floor
Siu Wai Industrial Centre
29-33 Wing Hong Street &
68 King Lam Street, Cheung Sha Wan
Kowloon
Phone: +852-27861706 / 27861741
Telefax: +852-27858664

Hungary

GRUNDFOS Hungária Kft.
Tópark u. 8
H-2045 Törökbálint,
Phone: +36-23 511 110
Telefax: +36-23 511 111

India

GRUNDFOS Pumps India Private Limited
118 Old Mahabalipuram Road
Thoraiakkam
Chennai 600 096
Phone: +91-44 2496 6800

Indonesia

PT. GRUNDFOS POMPA
Graha Intirub Lt. 2 & 3
Jln. Ciliitan Besar No.454. Makasar,
Jakarta Timur
ID-Jakarta 13650
Phone: +62 21-469-51900
Telefax: +62 21-460 6910 / 460 6901

Ireland

GRUNDFOS (Ireland) Ltd.
Unit A, Merrywell Business Park
Ballymount Road Lower
Dublin 12
Phone: +353-1-4089 800
Telefax: +353-1-4089 830

Italy

GRUNDFOS Pompe Italia S.r.l.
Via Gran Sasso 4
I-20060 Truccazzano (Milano)
Tel.: +39-02-95838112
Telefax: +39-02-95309290 / 95838461

Japan

GRUNDFOS Pumps K.K.
1-2-3, Shin-Miyakoda, Kita-ku,
Hamamatsu
431-2103 Japan
Phone: +81 53 428 4760
Telefax: +81 53 428 5005

Korea

GRUNDFOS Pumps Korea Ltd.
6th Floor, Aju Building 679-5
Yeoksam-dong, Kangnam-ku, 135-916
Seoul, Korea
Phone: +82-2-5317 600
Telefax: +82-2-5633 725

Latvia

SIA GRUNDFOS Pumps Latvia
Deglava biznesa centrs
Augusta Deglava ielā 60, LV-1035, Rīga,
Tālr.: + 371 714 9640, 7 149 641
Fakss: + 371 914 9646

Lithuania

GRUNDFOS Pumps UAB
Smolensko g. 6
LT-03201 Vilnius
Tel: + 370 52 395 430
Fax: + 370 52 395 431

Malaysia

GRUNDFOS Pumps Sdn. Bhd.
7 Jalan Peguam U1/25
Glenmarie Industrial Park
40150 Shah Alam
Selangor
Phone: +60-3-5569 2922
Telefax: +60-3-5569 2866

Mexico

Bombas GRUNDFOS de México S.A. de
C.V.
Boulevard TLC No. 15
Parque Industrial Tívala Aeropuerto
Apodaca, N.L. 66600
Phone: +52-81-8144 4000
Telefax: +52-81-8144 4010

Netherlands

GRUNDFOS Netherlands
Veluwezoom 35
1326 AE Almere
Postbus 22015
1302 CA ALMERE
Tel.: +31-88-478 6336
Telefax: +31-88-478 6332
E-mail: info_gnl@grundfos.com

New Zealand

GRUNDFOS Pumps NZ Ltd.
17 Beatrice Tinsley Crescent
North Harbour Industrial Estate
Albany, Auckland
Phone: +64-9-415 3240
Telefax: +64-9-415 3250

Norway

GRUNDFOS Pumper A/S
Strømsveien 344
Postboks 235, Leirdal
N-1011 Oslo
Tlf.: +47-22 90 47 00
Telefax: +47-22 32 21 50

Poland

GRUNDFOS Pompy Sp. z o.o.
ul. Klonowa 23
Baranowo k. Poznania
PL-62-081 Przeźmierowo
Tel: (+48-61) 650 13 00
Fax: (+48-61) 650 13 50

Portugal

Bombas GRUNDFOS Portugal, S.A.
Rua Calvet de Magalhães, 241
Apartado 1079
P-2770-153 Paço de Arcos
Tel.: +351-21-440 76 00
Telefax: +351-21-440 76 90

Romania

GRUNDFOS Pompe România SRL
Bd. Biruintei, nr 103
Pantelimon county Ilfov
Phone: +40 21 200 4100
Telefax: +40 21 200 4101
E-mail: romania@grundfos.ro

Russia

ООО Грундфос Россия
ул. Школьная, 39-41
Москва, RU-109544, Russia
Тел. (+7) 495 564-88-00 (495) 737-30-00
Факс (+7) 495 564 8811
E-mail grundfos.moscow@grundfos.com

Serbia

Grundfos Srbija d.o.o.
Omladinskih brigada 90b
11070 Novi Beograd
Phone: +381 11 2258 740
Telefax: +381 11 2281 769
www.rs.grundfos.com

Singapore

GRUNDFOS (Singapore) Pte. Ltd.
25 Jalan Tukang
Singapore 619264
Phone: +65-6681 9688
Telefax: +65-6681 9689

Slovakia

GRUNDFOS s.r.o.
Prievozská 4D
821 09 BRATISLAVA
Phona: +421 2 5020 1426
sk.grundfos.com

Slovenia

GRUNDFOS LJUBLJANA, d.o.o.
Leskoškova 9e, 1122 Ljubljana
Phone: +386 (0) 1 568 06 10
Telefax: +386 (0)1 568 06 19
E-mail: tehnikasi@grundfos.com

South Africa

GRUNDFOS (PTY) LTD
Corner Mountjoy and George Allen Roads
Wilbart Ext. 2
Bedfordview 2008
Phone: (+27) 11 579 4800
Fax: (+27) 11 455 6066
E-mail: lsmart@grundfos.com

Spain

Bombas GRUNDFOS España S.A.
Camino de la Fuentequilla, s/n
E-28110 Algete (Madrid)
Tel.: +34-91-848 8800
Telefax: +34-91-628 0465

Sweden

GRUNDFOS AB
Box 333 (Lunnagårdsgatan 6)
431 24 Mölndal
Tel.: +46 31 332 23 000
Telefax: +46 31 331 94 60

Switzerland

GRUNDFOS Pumpen AG
Bruggacherstrasse 10
CH-8117 Fällanden/ZH
Tel.: +41-44-806 8111
Telefax: +41-44-806 8115

Taiwan

GRUNDFOS Pumps (Taiwan) Ltd.
7 Floor, 219 Min-Chuan Road
Taichung, Taiwan, R.O.C.
Phone: +886-4-2305 0868
Telefax: +886-4-2305 0878

Thailand

GRUNDFOS (Thailand) Ltd.
92 Chaloe Phrakiat Rama 9 Road,
Dokmai, Pravej, Bangkok 10250
Phone: +66-2-725 8999
Telefax: +66-2-725 8998

Turkey

GRUNDFOS POMPA San. ve Tic. Ltd. Sti.
Gebze Organize Sanayi Bölgesi
Ihsan dede Caddesi,
2. yol 200. Sokak No. 204
41490 Gebze/ Kocaeli
Phone: +90 - 262-679 7979
Telefax: +90 - 262-679 7905
E-mail: satis@grundfos.com

Ukraine

Бізнес Центр Європа
Столицне шосе, 103
м. Київ, 03131, Україна
Телефон: (+38 044) 237 04 00
Факс.: (+38 044) 237 04 01
E-mail: ukraine@grundfos.com

United Arab Emirates

GRUNDFOS Gulf Distribution
P.O. Box 16768
Jebel Ali Free Zone
Dubai
Phone: +971 4 8815 166
Telefax: +971 4 8815 136

United Kingdom

GRUNDFOS Pumps Ltd.
Grovebury Road
Leighton Buzzard/Beds. LU7 4TL
Phone: +44-1525-850000
Telefax: +44-1525-850011

U.S.A.

GRUNDFOS Pumps Corporation
17100 West 118th Terrace
Olathe, Kansas 66061
Phone: +1-913-227-3400
Telefax: +1-913-227-3500

Uzbekistan

Grundfos Tashkent, Uzbekistan The
Representative Office of Grundfos
Kazakhstan in Uzbekistan
38a, Oybek street, Tashkent
Телефон: (+998) 71 150 3290 / 71 150
3291
Факс: (+998) 71 150 3292

Addresses Revised 14.03.2018

99253352 0618
ECM: 1220099

The name Grundfos, the Grundfos logo, and **be think innovate** are registered trademarks owned by Grundfos Holding A/S or Grundfos A/S, Denmark. All rights reserved worldwide. © Copyright Grundfos Holding A/S

www.grundfos.com



TM.by
ONLINE STORE

<https://tm.by>
Интернет-магазин