

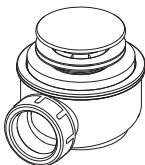

A465-50 ■ A466-50 ■ A476-50

[mm]

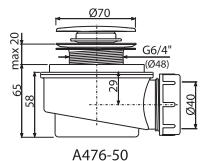

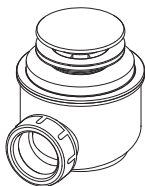
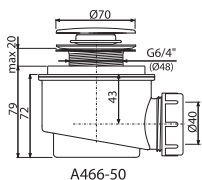
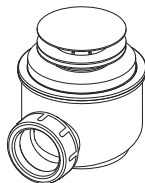
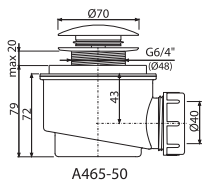
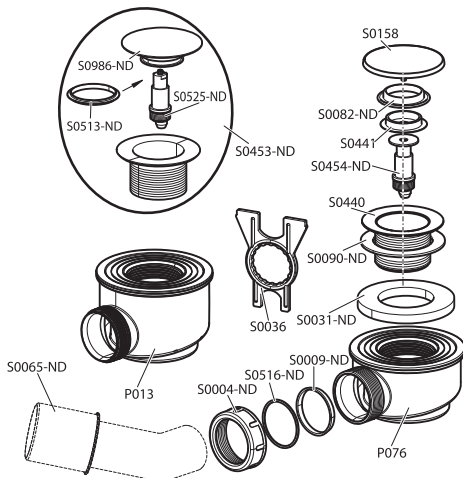

ZÍRAVINA / CAUSTIC

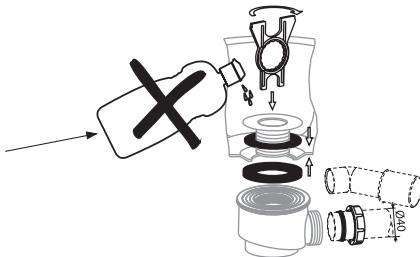

Alca plast, s. r. o.
 Bratislavská 2846, 690 02 Břeclav, Česká republika
 Tel.: +420 519 821 117 – prodej ČR
 Tel.: +420 519 821 041 – export, Fax: +420 519 821 083
 e-mail: alcaplast@alcaplast.cz, www.alcaplast.cz

© 2016 Alcaplast, s.r.o.

RO / 01 / 16