

6 736 00/01/02/03

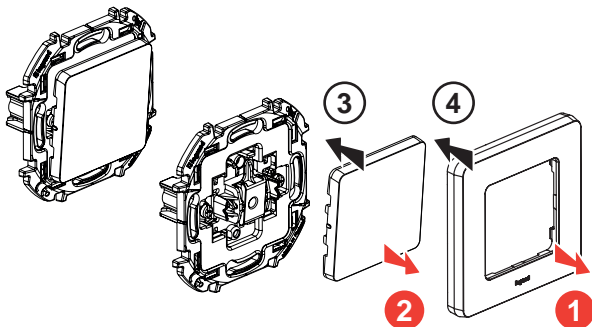

1 **10 AX, 250 B~**

	≤ 2,5 mm ²
	13 mm

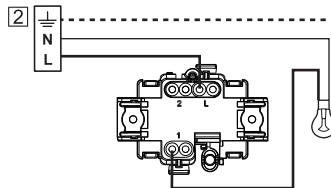

6 736 10/11/12/13

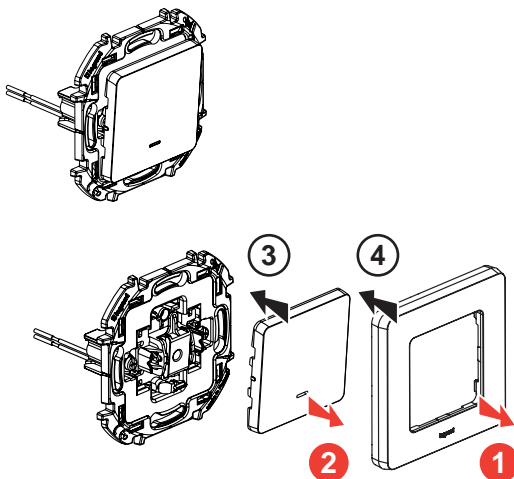

1 **10 AX, 250 B~**

	≤ 2,5 mm ²
	13 mm

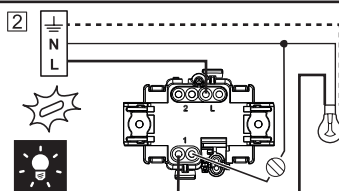
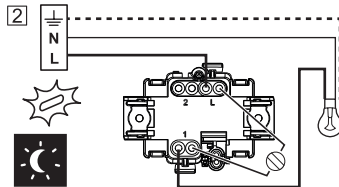

6 736 20/21/22/23

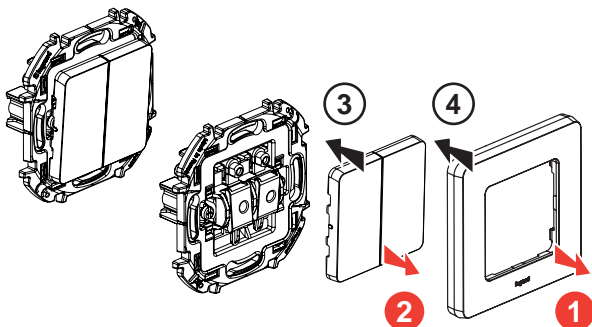

1 **10 AX, 250 B~**

	≤ 2,5 mm ²
	13 mm

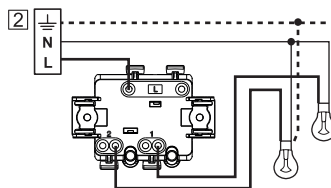

6 736 30/31/32/33

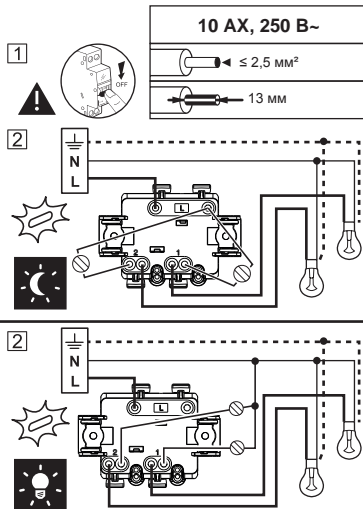
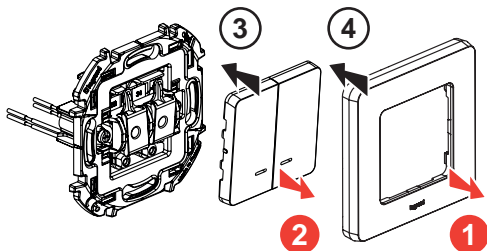
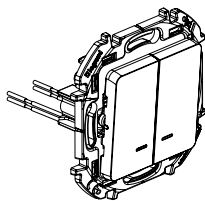

6 736 40/41/42/43

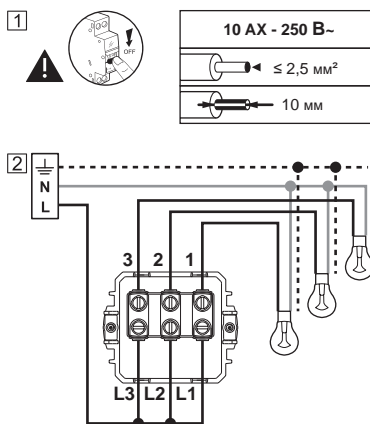
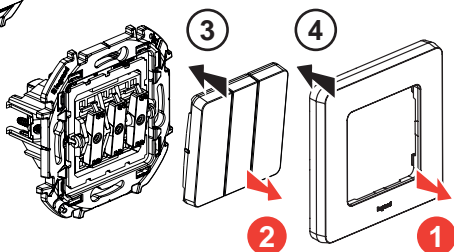
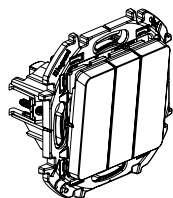



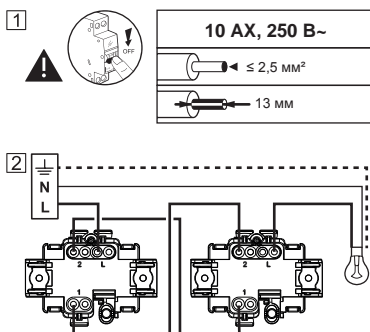
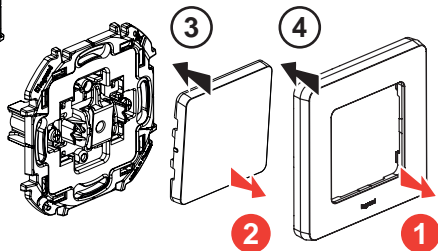
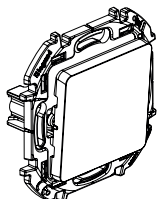

6 736 50/51/52/53

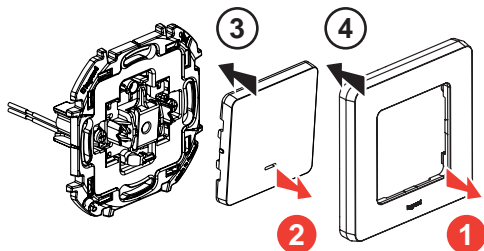
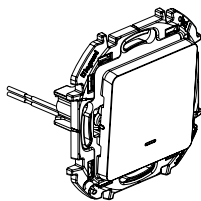

6 736 60/61/62/63





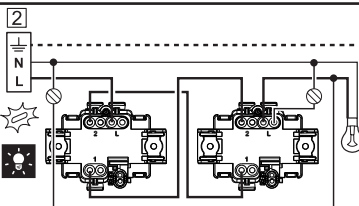
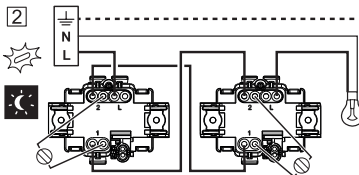

1   

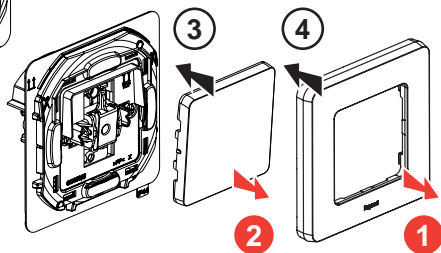
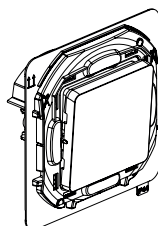

10 AX, 250 B~
 $\leq 2,5 \text{ mm}^2$
 13 MM



6 736 70/71/72/73





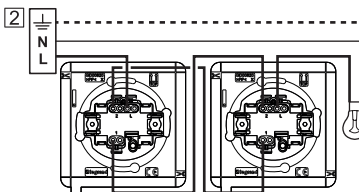

1   

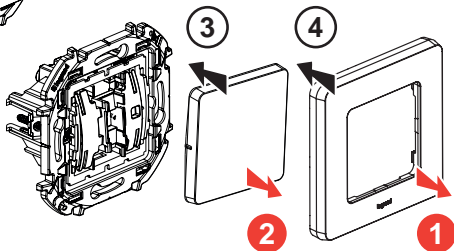
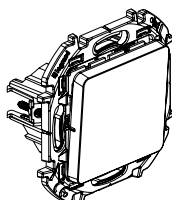

10 AX, 250 B~, IP44
 $\leq 2,5 \text{ mm}^2$
 13 MM



6 736 80/81/82/83



1   

10 AX, 250 B~
 $\leq 2,5 \text{ mm}^2$
 10 MM

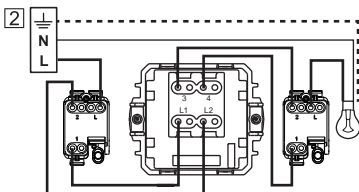

6 736 90/91/92/93

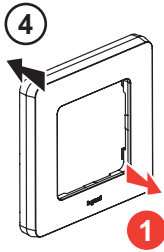
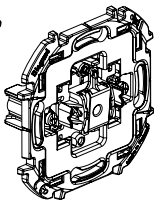
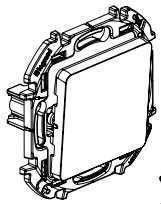

1



6 A, 250 B~

$\leq 2,5 \text{ mm}^2$

13 mm

2

