

I-0456



NEW
TRENDY

NEW TRENDY Sp. z.o.o.

Taszarowo 18 90

62-100 Wągrowiec

serwis@newtrendy.pl

tel/fax 67 262 12 66

SUPERIA

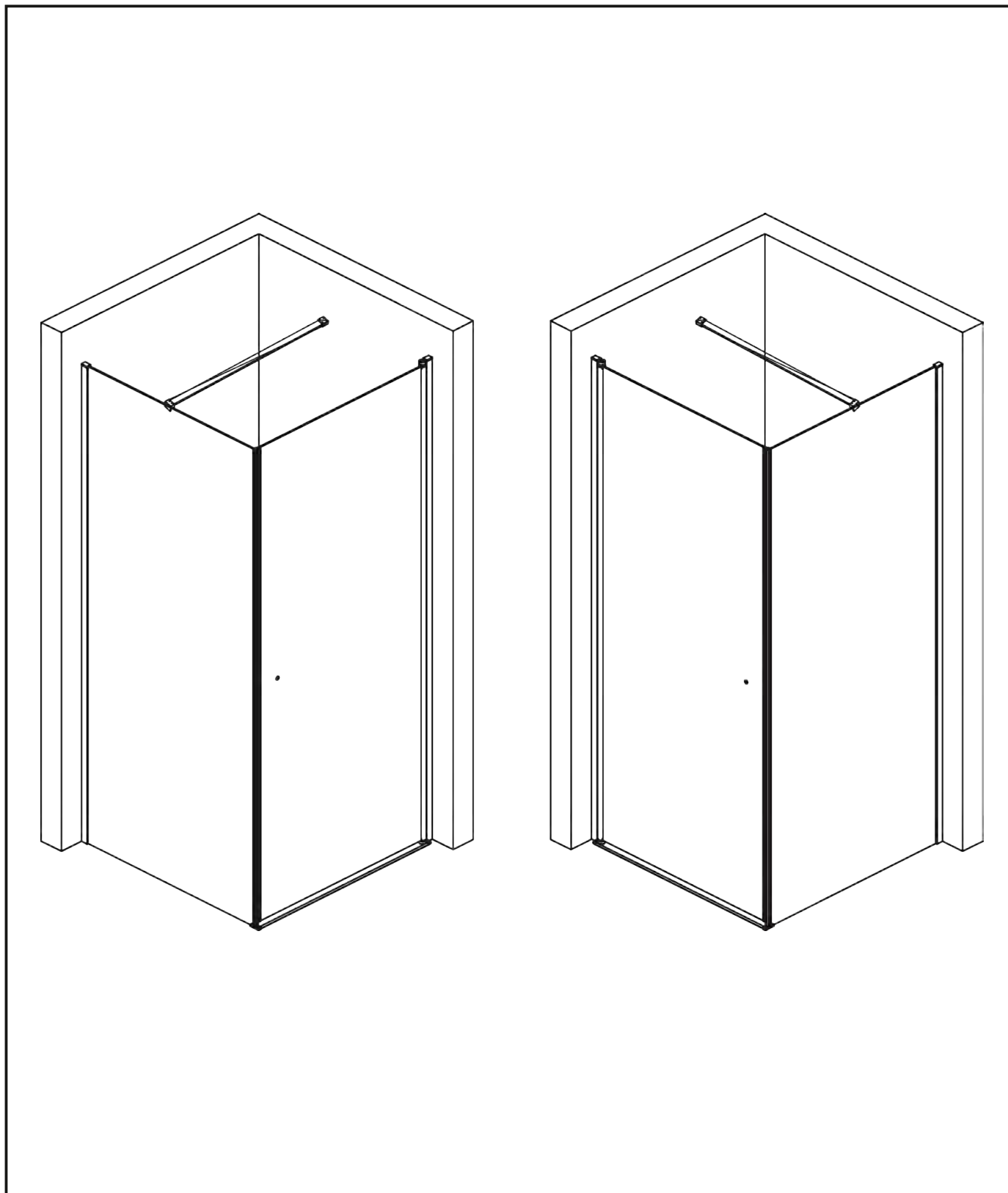

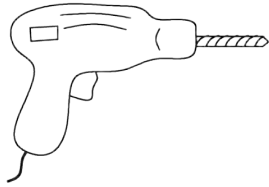
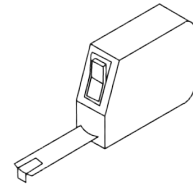
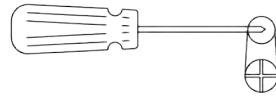
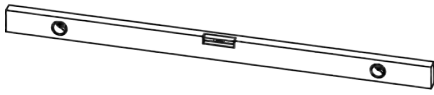



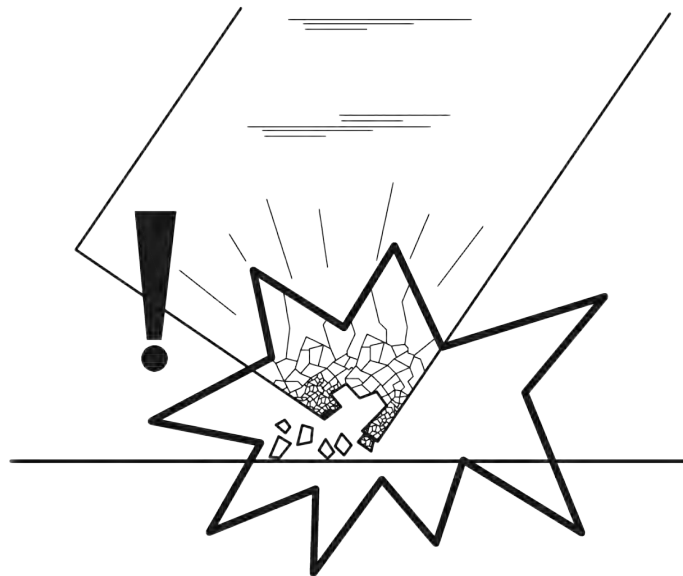
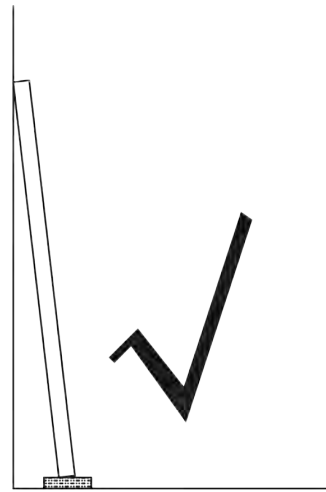
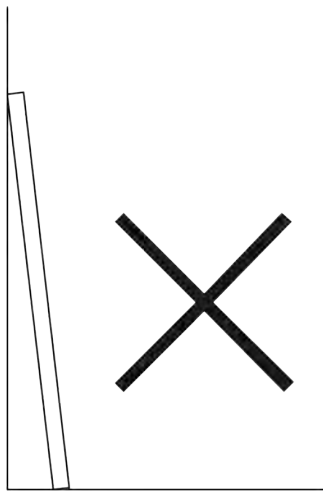
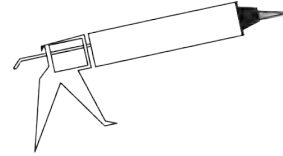

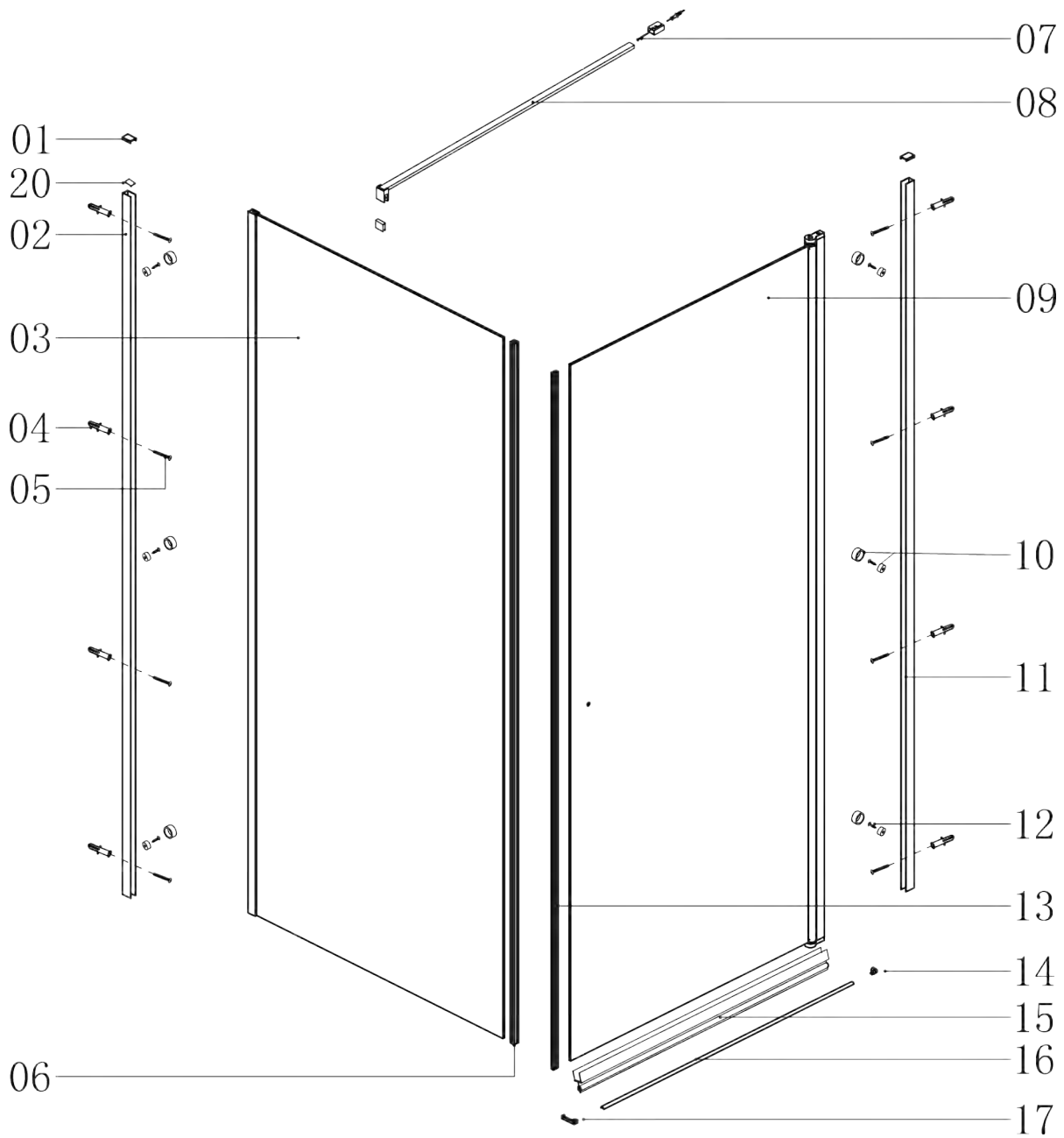















$\phi 6$ $\phi 2.8$





serial number	graphical	name	quantity	remarks
1			2 PCS	
2		S	1 PCS	
3			1 PCS	
4			9 PCS	
5		ST3. 9X35	8 PCS	
6			1 PCS	
7		ST3. 9X35	1 PCS	
8			1 PCS	
9			1 PCS	
10			6 PCS	
11		L	1 PCS	
12		ST3. 5X9. 5	6 PCS	
13			1 PCS	
14			2 PCS	
15			1 PCS	
16			1 PCS	
17			2 PCS	
18		M3	1 PCS	
19			1 PCS	
20			1 PCS	

WYMIAR/DIMENSIONS	A	B
80x80	78-79,5	77,5-79
90x90	88-89,5	87,5-89

