





















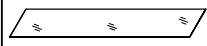
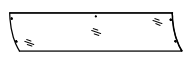

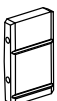

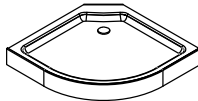
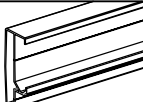



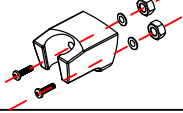

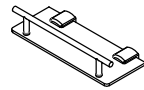

|   |   |   |   |   |   |   |  |   |
|---|---|---|---|---|---|---|--|---|
| A |            | 8 | I |            | 2 | Q |           | 4 |
| B | <br>ST4X40 | 8 | J | <br>ST4X10 | 8 | R | <br>ST4X8 | 4 |
| C |            | 2 | K |            | 4 | S |           | 1 |
| D |            | 2 | L | <br>ST4X10 | 4 | T |           | 1 |
| E |            | 2 | M |            | 2 | U |           | 1 |
| F |            | 4 | N |            | 2 | V |           | 1 |
| G |            | 2 | O |            | 2 |   |  |   |
| H |            | 4 | P |           | 2 |   |  |   |

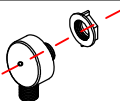
|    |   |   |    |   |    |    |   |   |
|----|---|---|----|---|----|----|---|---|
| a1 |  | 1 | f1 |            | 2  | k1 |  | 1 |
| b1 |  | 1 | g1 |            | 1  | l1 |  | 1 |
| c1 |  | 1 | h1 | <br>ST4X12 | 28 | m1 |  | 1 |
| d1 |  | 1 | i1 |            | 1  |    |   |   |
| e1 |  | 1 | j1 |            | 2  |    |   |   |

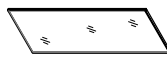

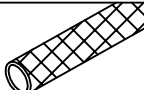
Ø6,Ø2.8

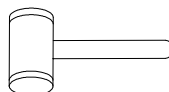
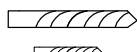
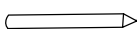
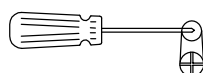
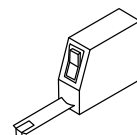
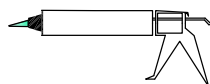
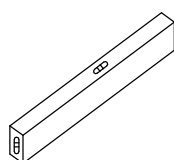
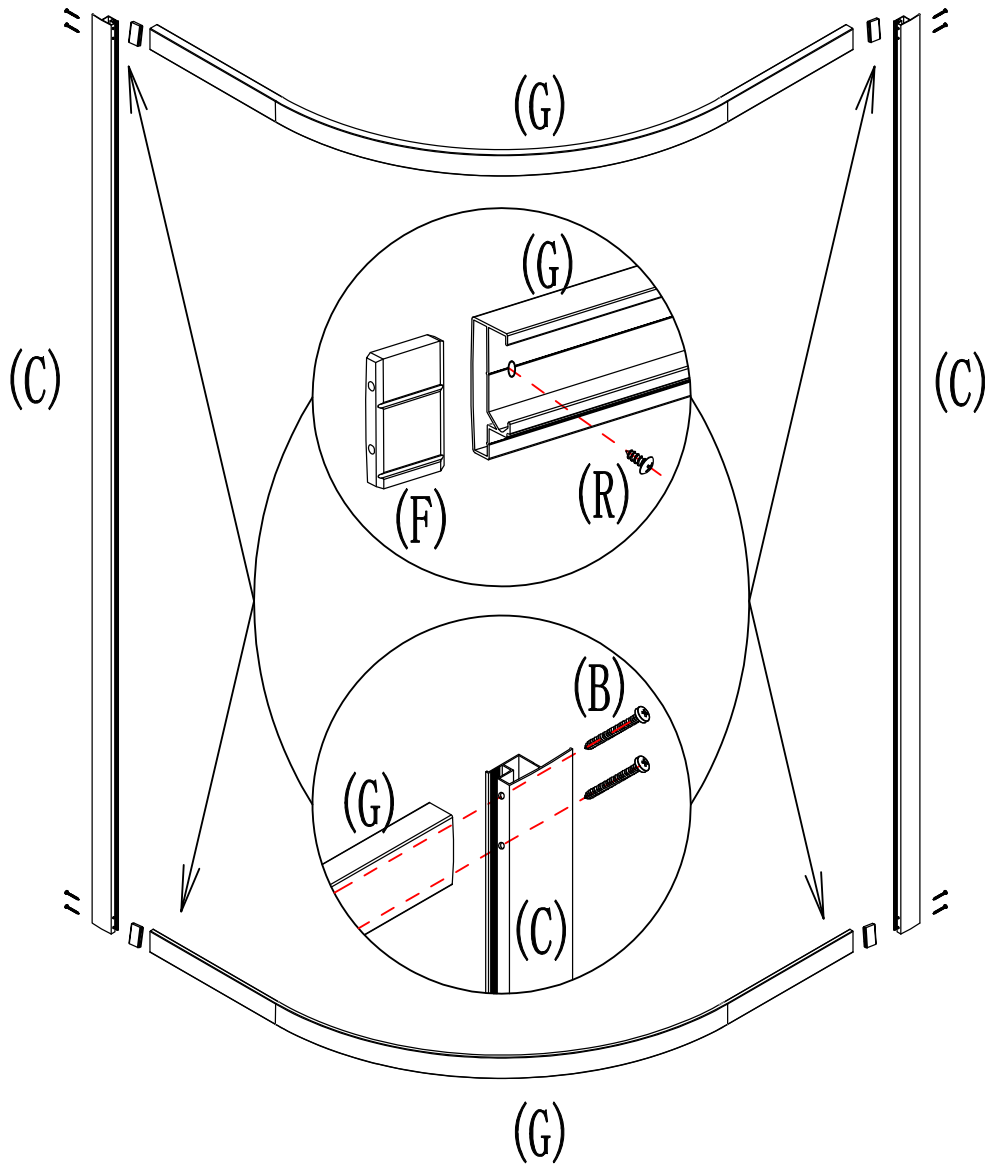
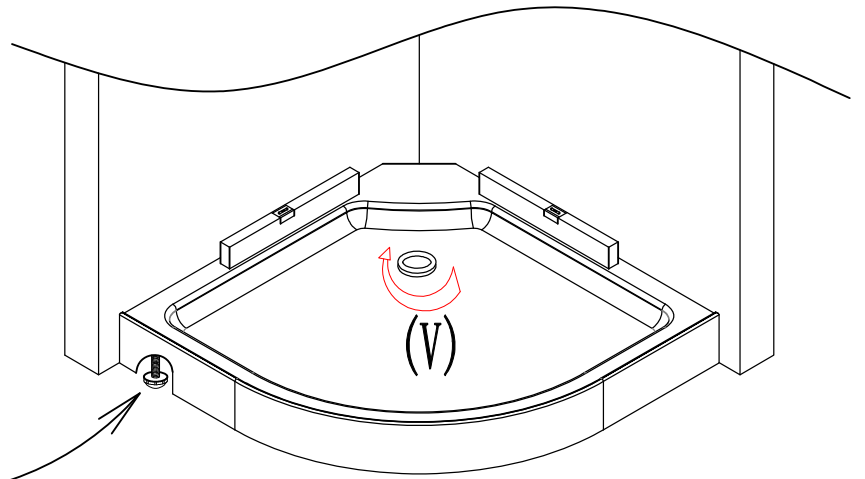
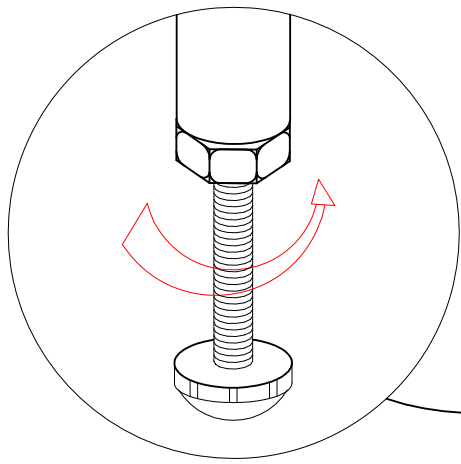

< 1 >

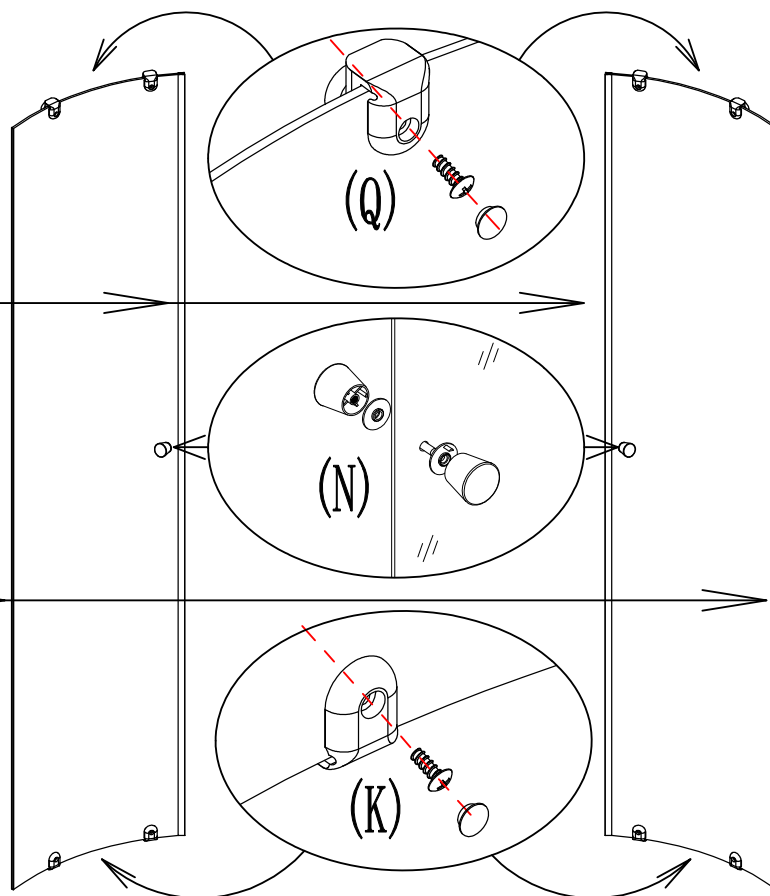
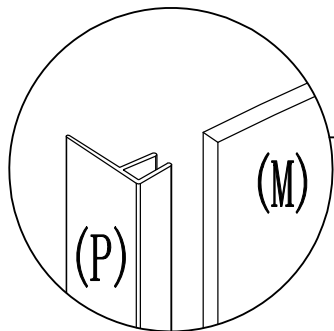
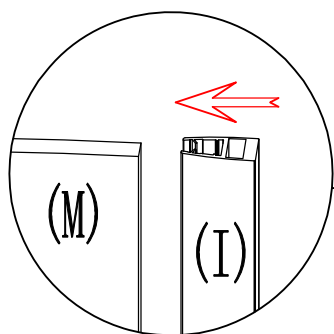
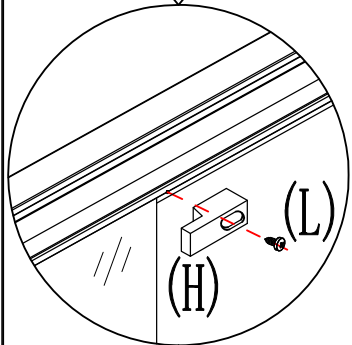
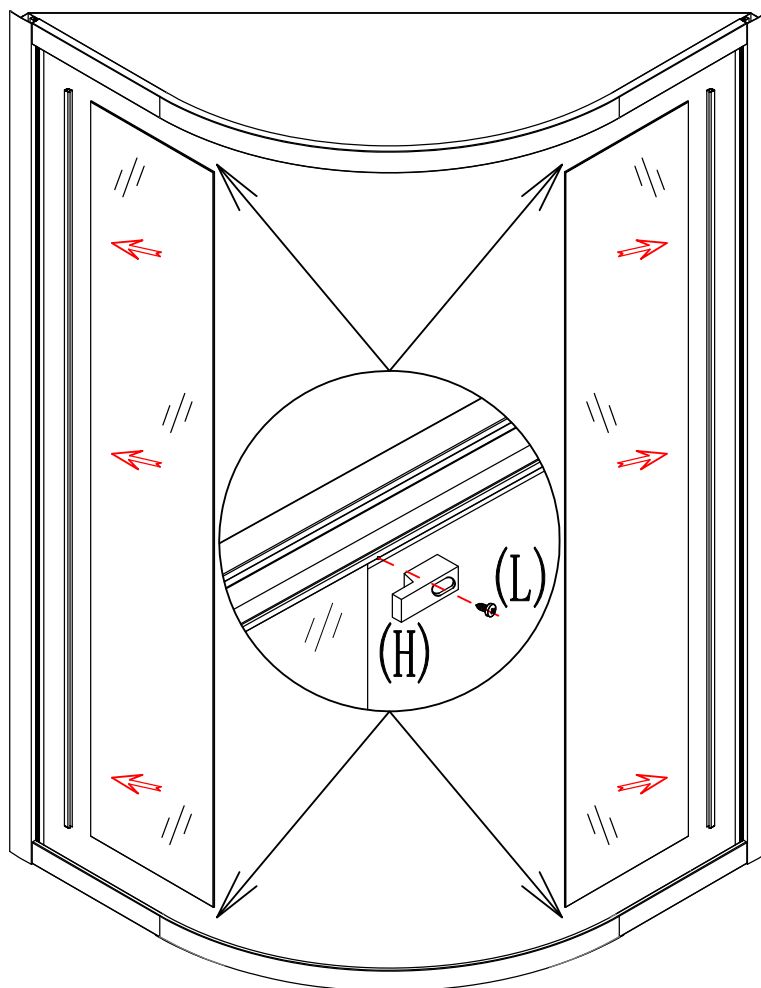
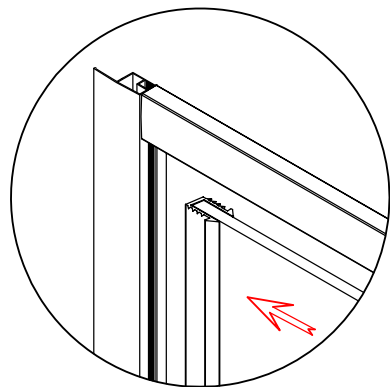
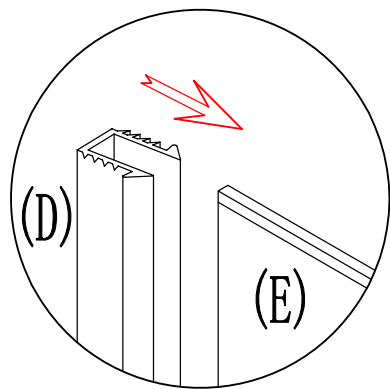

< 2 >

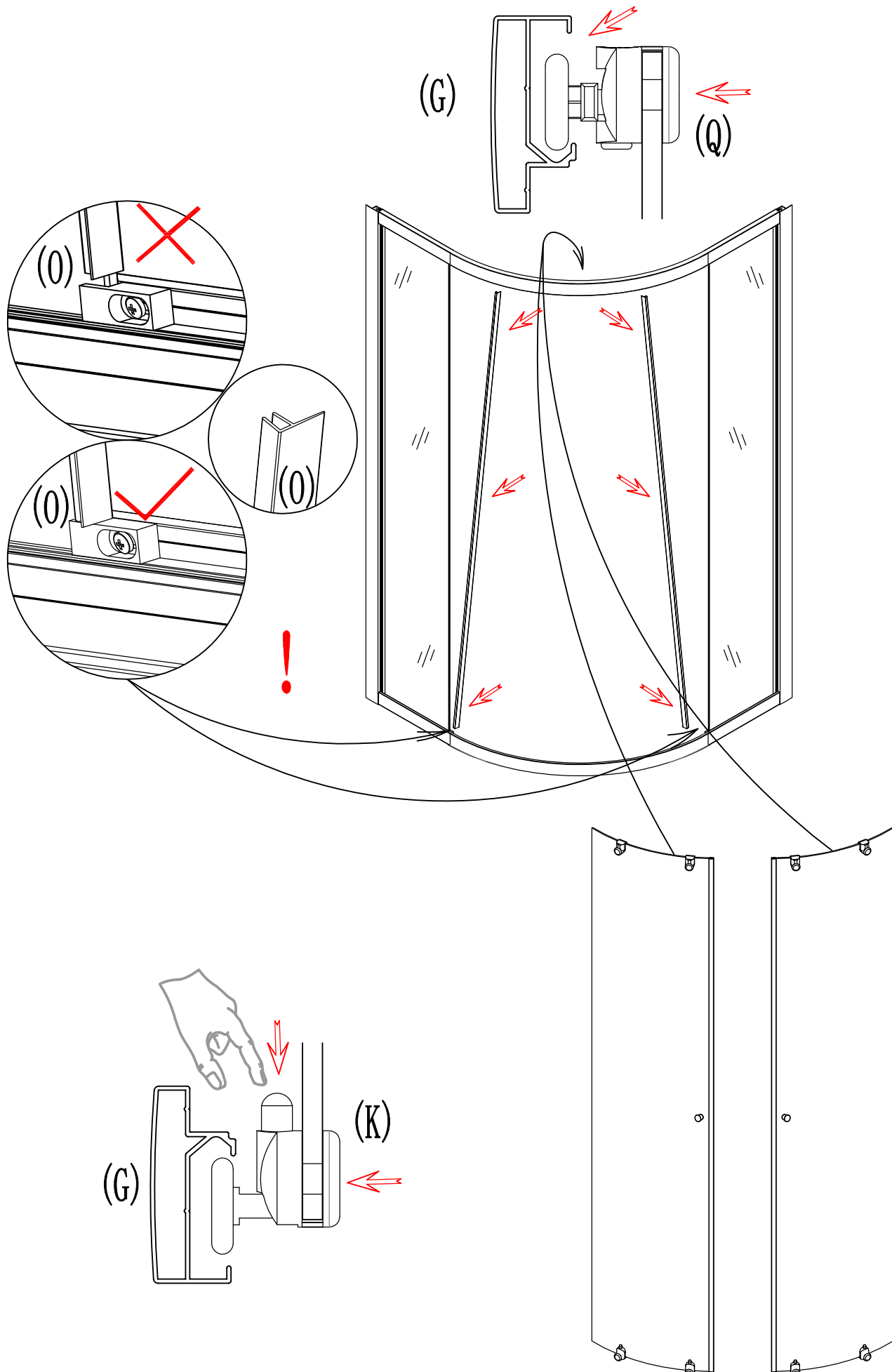

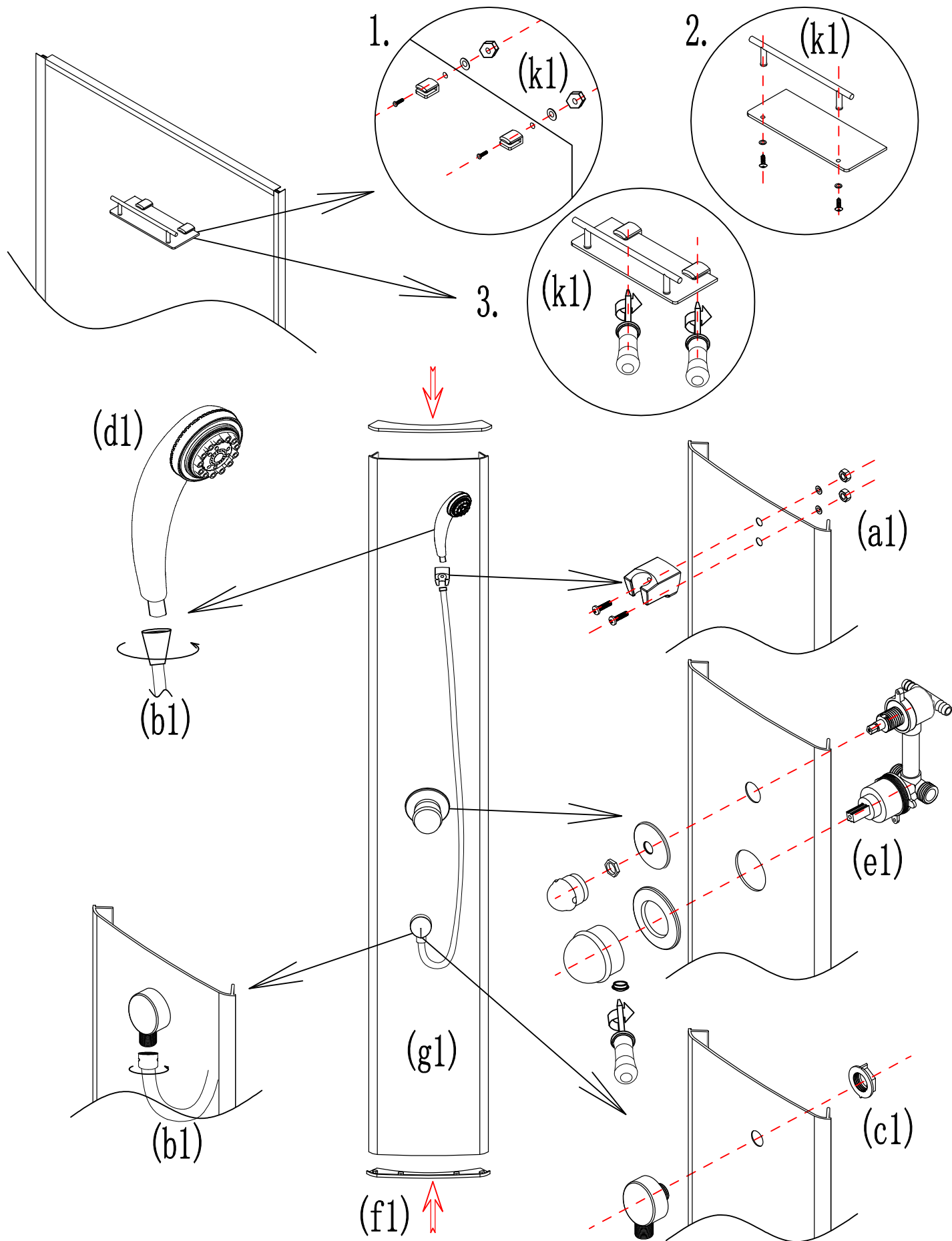



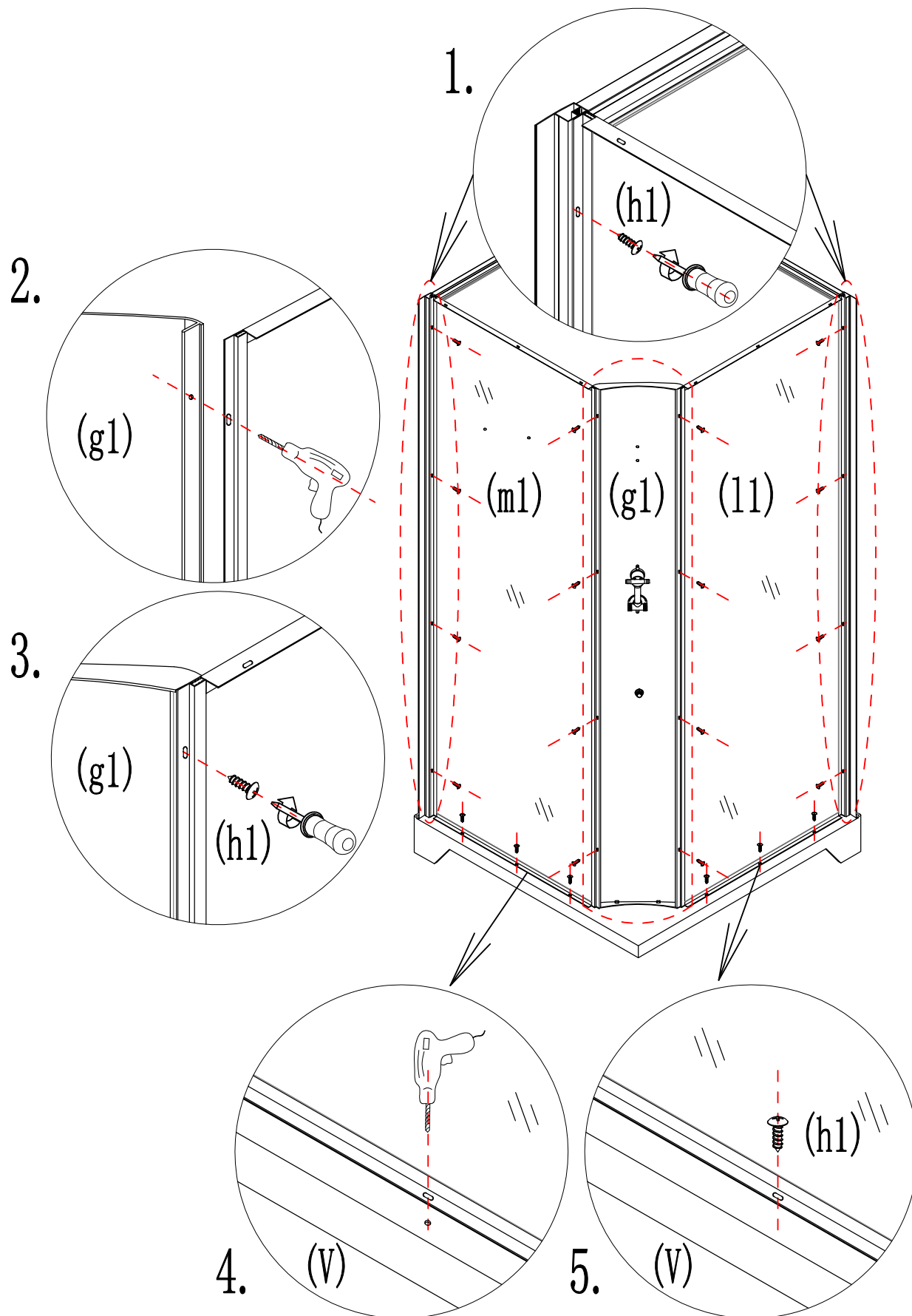

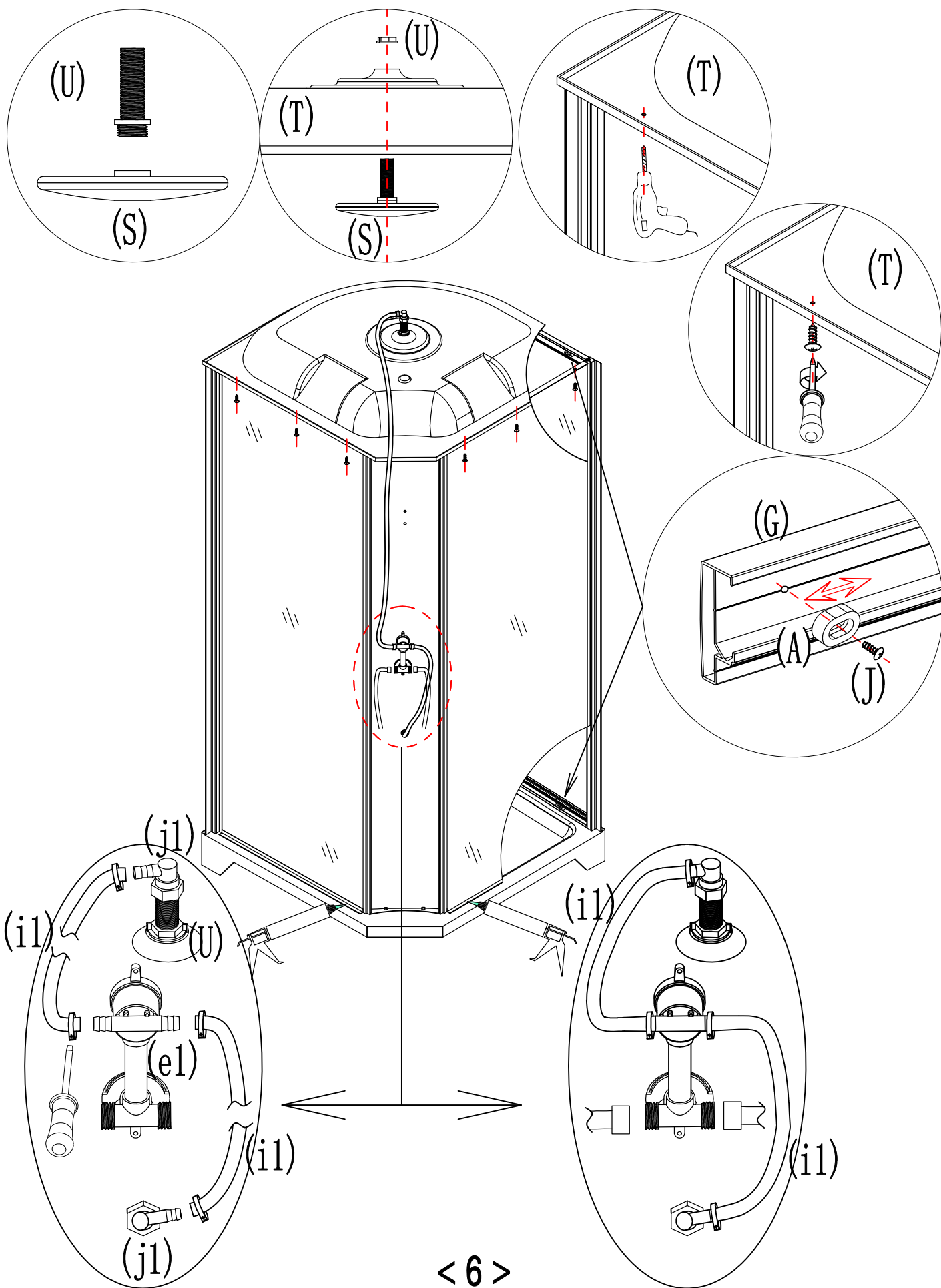

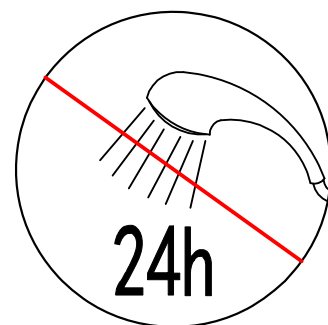
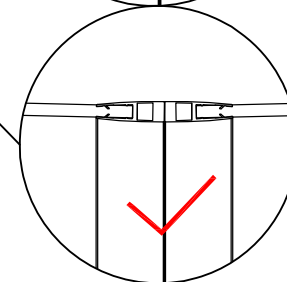
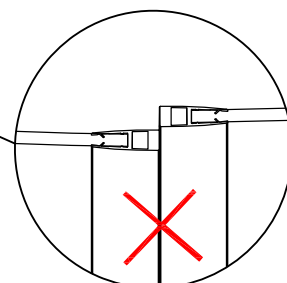
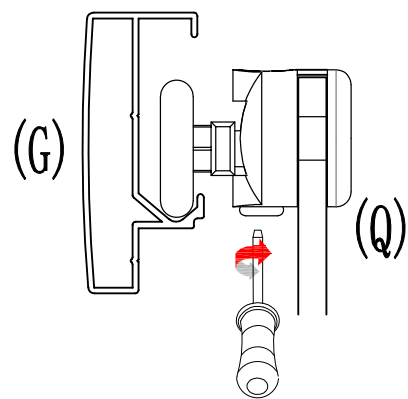
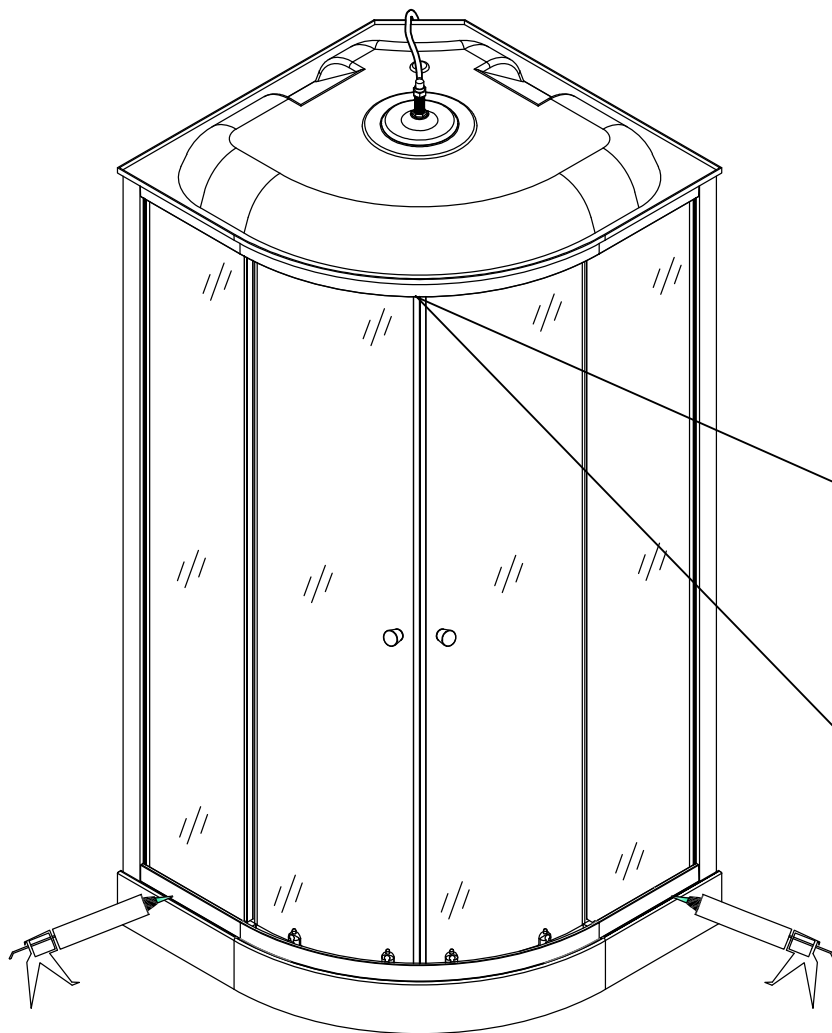

<7>

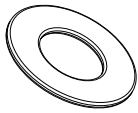

M12=6

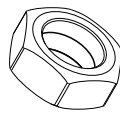

M12=23

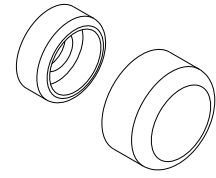

=3

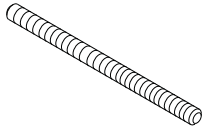

M12 X 10CM=1

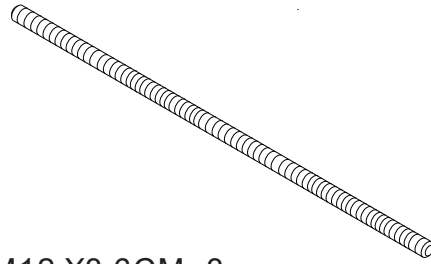

M12 X3 6CM=3

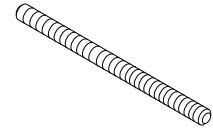

M12 X 18CM=1

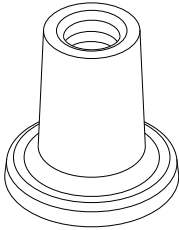

=5

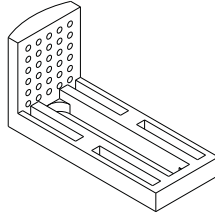

=3

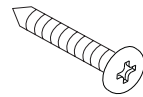

M4 X 20=3

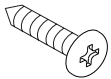

M4 X 12=4

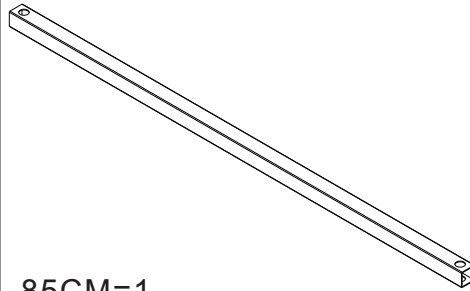

85CM=1

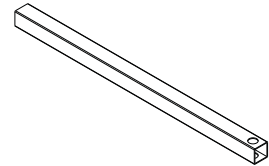

45CM=2

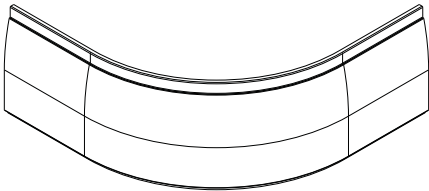

=1

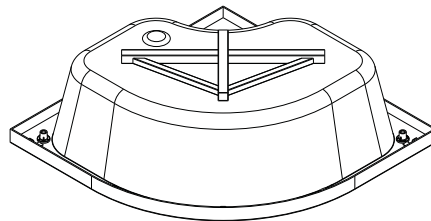

=1

