

гостиная НЕНСИ 1 / NANCY 1

Код ТН ВЭД ЕАЭС

9403 60 100 1
9403 90 300 0

отрезать
и приклеить

2800	2000	466

Левое исполнение/
Left

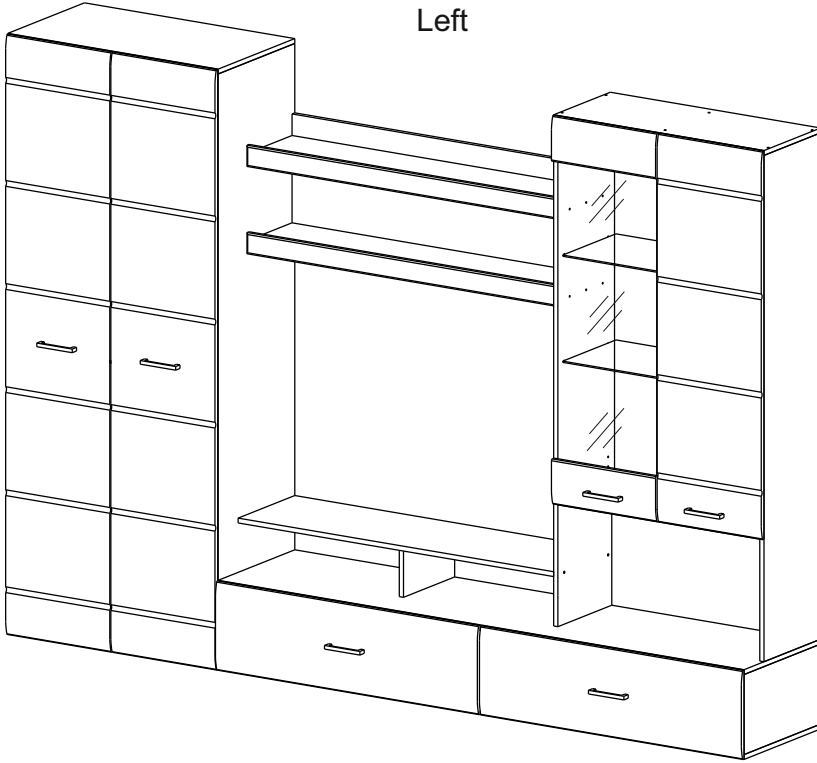

корпус [39НВГ1 / 2547
39НЯГ1 / 2570
39НДГ1 / 2559

фасад [39ФБГ1 / 2581
39ФУГ1 / 2831

Правое исполнение/
Right

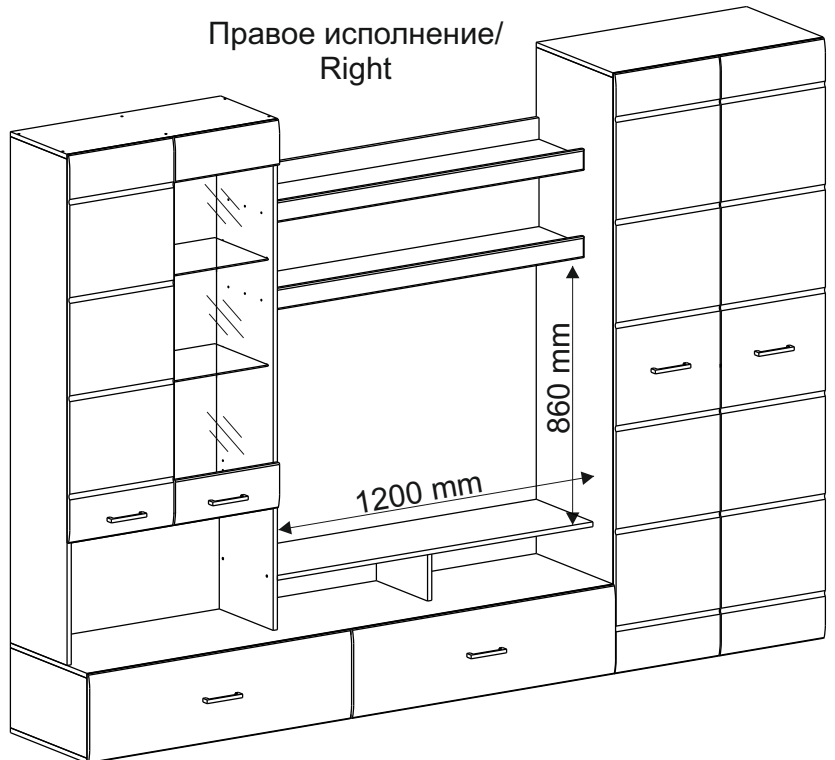

(PL) Instrukcja montażu

(CZ) Návod k montáži

(D) Montageanleitung

(GB) Assembly instruction

(F) Model d'emploi

(HU) Szerelési útmutató

(I) Istruzione di montaggio

(NL) Handleiding voor de montage



(RU) Инструкция по монтажу

(RO) Instrucțiuni de montare

(SK) Návod k montáži

(TR) Montaj talimatı

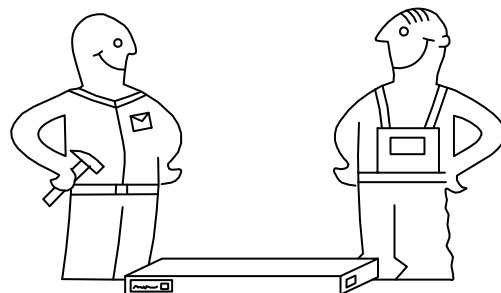
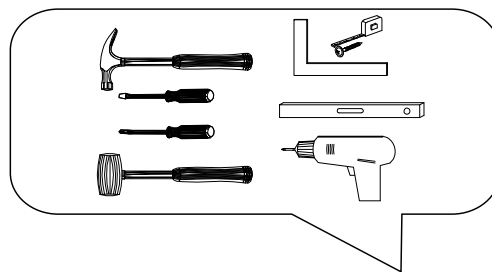

⚠ Uwaga • Upozornění • Achtung • Attention • Caution • Figyelem • Attenzione • Opgelet • Внимание • Atenție • Upozornenie • Dikkat ⚠	
PL	Czyszczenie należy wykonać wyłącznie za pomocą ściereczki lub lekko nawilżonego ręcznika. Nie stosować środków czyszczących do szorowania.
CZ	Čistění je nutné vykonávat výhradně pomocí utěrky nebo lehce navlhčeného ručníku. Nepoužívejte čisticí prostředky obsahující abrazivní částice.
D	Bitte nur mit einem Staubtuch oder leicht feuchtem Lappen reinigen. Keine scheuernden Putzmittel verwenden.
GB	Please only clean with a duster or a damp cloth. Do not use any abrasive cleaners.
F	Le nettoyage se fait uniquement à l'aide d'un torchon ou d'une serviette légèrement mouillée.
HU	A tisztítás kizárólag törölrőruha vagy enyhén nedvesített törölköző segítségével végezhető. Súroló hatású tisztítószerket nem szabad használni.
I	Pulire esclusivamente con un panno o un asciugamano umido.
NL	Reinig alleen met een stofdoek of een lichtjes vochtige doek. Gebruik geen schurende poetsmiddelen.
RU	Очищайте от пыли тряпкой или слегка влажной ветошью. Не допускается применение чистящих средств, не предназначенных для ухода за мебелью.
RO	Curățarea trebuie efectuată numai cu o cârpă sau cu un prosop ușor umezit. Nu utilizați agenți de curățare abrazivi.
SK	Čistení je nutné vykonávať výhradne pomocí utierky alebo ľahko zvlhnutým ručníkom. Nepoužívajte čistiace prostriedky obsahujúci abrazívni častice.
TR	Lütfen sadece bir toz beziyile veya hafif nemli yumuşak bir bezle siliniz. Aşındırıcı temizlik malzemeleri kullanmayınız.

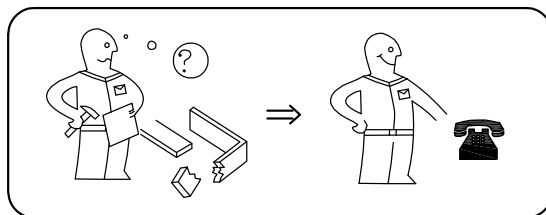
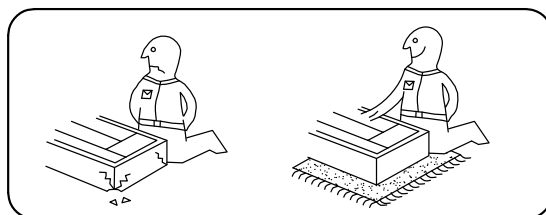

**Karta serwisowa • Servisní list • Service Karte • Service card • Carte de service • Szervizkártya
Scheda di servizio • Service kaart • Сервисная карта • Fisa service • Servisný list • Servis karti**

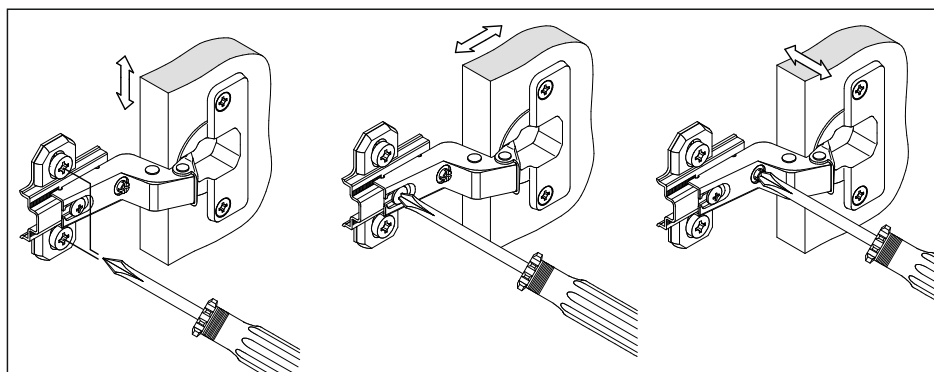
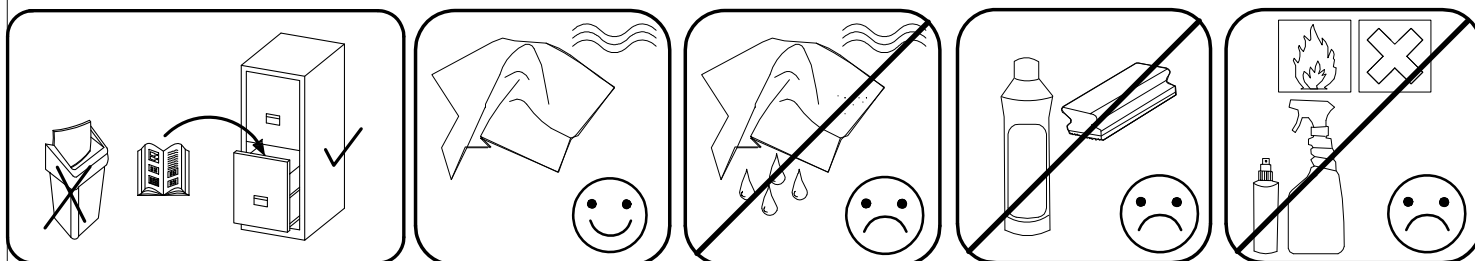











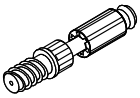

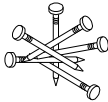
Комплектовочная ведомость / Set package sheet

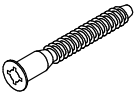
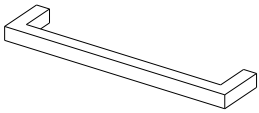
Упак/ Pack	Наименование	Description	Décor			Размер/ Size, mm	Кол-во/ Quantity	№
			Wenge	Ash light	Oak gold			
1	Фурнитура	Furniture/Cabinetry hardware				-	1	
2	Боковина	Side	Wenge	Ash light	Oak gold	163x298	1	1
	Боковина средн	Side middle				1252x330	1	3
	Боковина правая	Side right				1670x330	1	4
	Боковина левая	Side left				1670x330	1	5
	Боковина левая	Side left				1950x446	1	6
	Боковина правая	Side right				1950x446	1	7
	Вязка	Connecting element				1200x330	1	14
	Вязка	Connecting element				376x330	2	15
	Детали ящика	Side drawers				134x908	4	21
3	Боковина левая	Side left	Wenge	Ash light	Oak gold	264x446	2	2
	Боковина правая	Side right				264x446	2	38
	Крышка верх	Top high				2000x446	1	8
	Крышка низ	Top low				2000x446	1	9
	Вязка	Connecting element				1200x250	2	13
	Задник	Back element				1200x446	1	17
	Детали ящика	Side drawers				134x400	4	20
	ДВП	Back element				1996x286	1	31
	Соед. Элемент	Connecting Back element				-	-	-
Штанга	Wardrobe tube	-	-	-	763 мм	1	19	
4	Крышка шкаф	Top cabinet	Wenge	Ash light	Oak gold	800x446	2	10
	Крышка пенал	Top				800x330	1	11
	Вязка пенал	Connecting element				768x330	1	12
	Вязка шкаф	Connecting element cabinet				768x446	2	16
5	ДВП	Back element	Wenge	Ash light	White	400x940	2	28
	ДВП	Back element				410x796	1	29
	ДВП	Back element				399x796	1	30
	ДВП	Back element				416x796	1	18
	ДВП	Back element				1160x396	2	32
	ДВП	Back element				1276x396	2	33

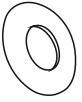
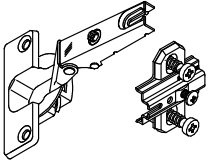
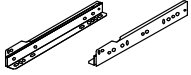
Продается отдельно/Sold separately

Упак/ Pack	Наименование	Description	Décor		Размер/ Size, mm	Кол-во/ Quantity	№
			White gl	Cappuccino gl			
1	Створка левая	Door left	White gl	Cappuccino gl	1980x396	1	22
	Створка правая	Door right			1980x396	1	23
	Створка	Door			1282x396	1	24
	Фасад верхний	Door element high			150x396	1	25
	Фасад нижний	Door element low			150x396	1	37
	Панель левая	Drawer panel left			294x996	1	26
	Панель правая	Drawer panel right			294x996	1	39
	Планка	Plank			1200x70	2	27
2	Стеклополка	Glass shelves	прозрачное/transparent		365x310	2	35
	Стекло	Glass			1030x370	1	36

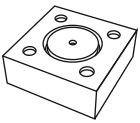
4

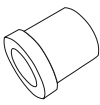
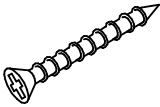
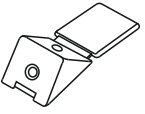
1		2		73		48	2x20	49	
									
26 x		26 x		16 x		100 x		2 x	
5	7x50	126	C42 128 mm	72		6	6,3x10,5	45	
									
66 x		6 x		40 x		34 x		20 x	
91	A	24	400 mm	18	3,5x15	15		41	
									
13 x		2 x		106 x		1 x		8 x	
38		70	d5	21		14	3,5x30	44	
									
10 x		18 x		6 x		10 x		6 x	

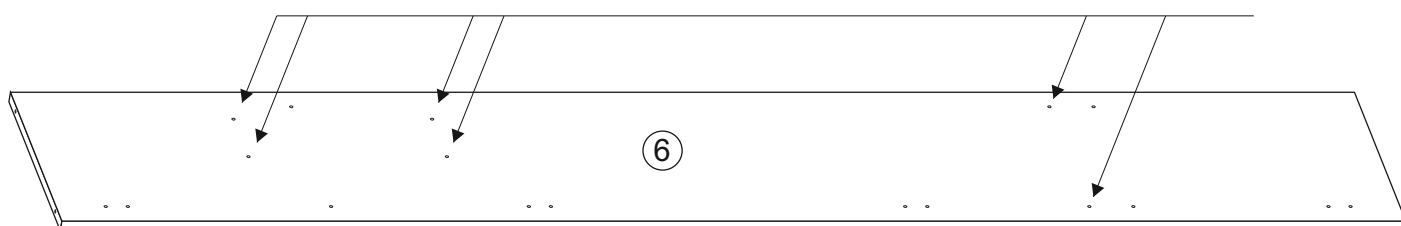
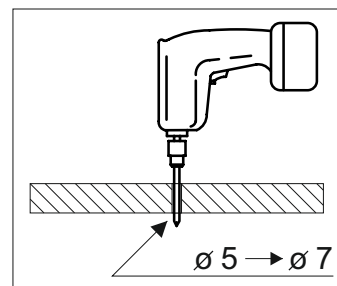
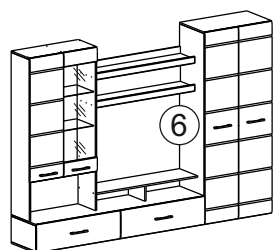
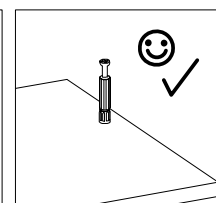
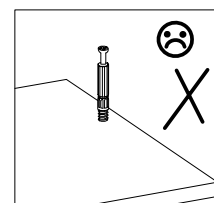
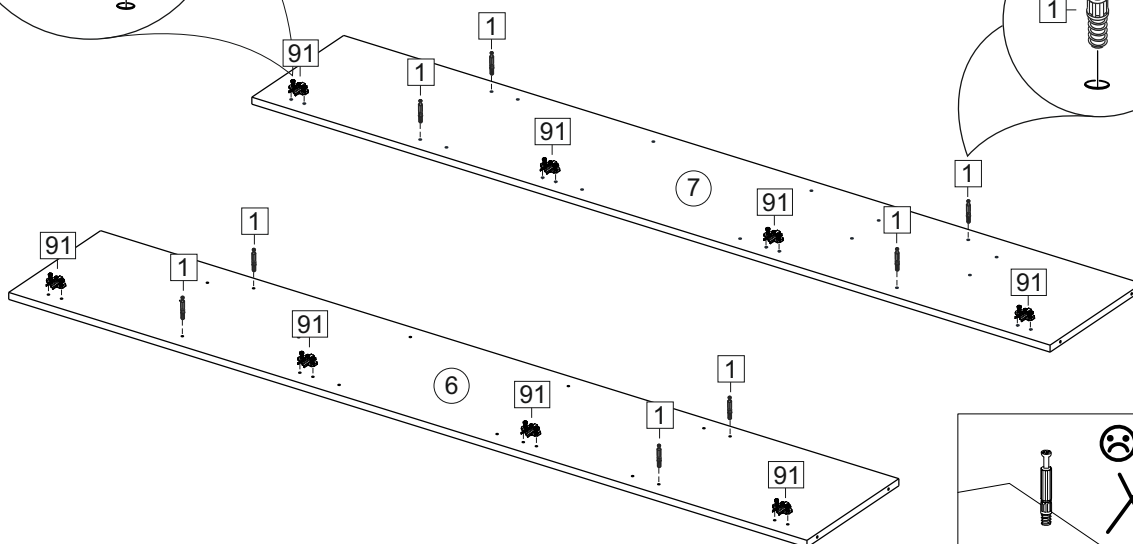
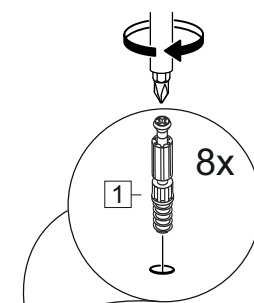
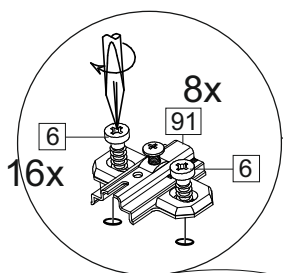
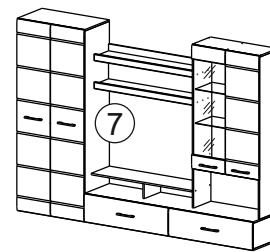
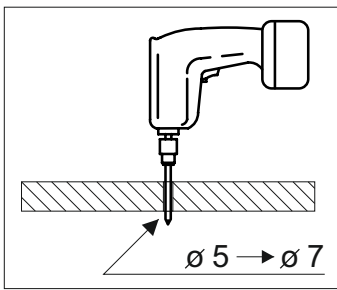

6

