

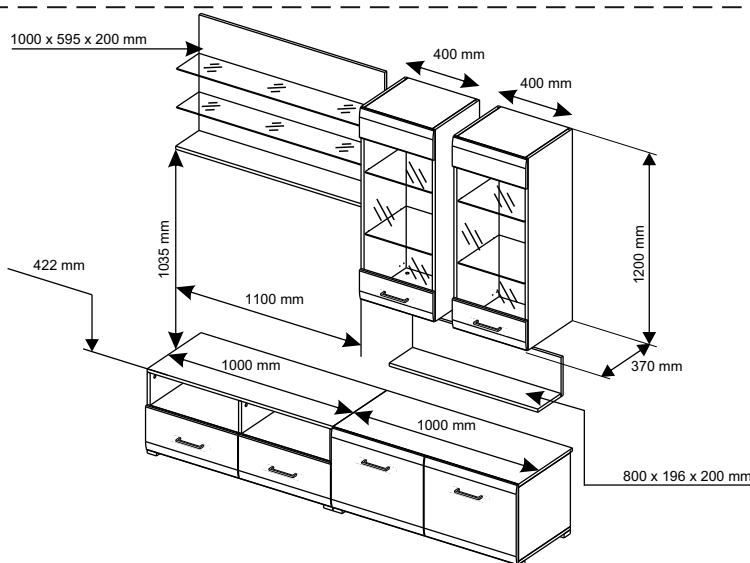

гостиная НЕНСИ 3 / NENCY 3

Код ТН ВЭД ЕАЭС

9403 60 100 1
9403 90 300 0

отрезать
и приклеить

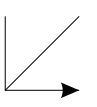

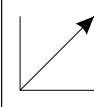
		
2000	2000	466

корпус
39НВГЗ / 2548
39НЯГЗ / 2571
39НДГЗ / 2560

фасад
39ФБГЗ / 2582
39ФУГЗ / 2824

Oak gold - Дуб золотой
Ash light - Ясень светл

Комплектовочная ведомость / Set package sheet

Упак/ Pack	Наименование	Description	Décor			Размер/ Size, mm	Кол-во/ Quantity	№
			Wenge	Ash light	Oak gold			
1	Фурнитура	Furniture/Cabinetry hardware	-	-	-	-	1	
2	Боковина	Side	Wenge	Ash light	Oak gold	960x350	4	7
	Вязка	Connecting element				368x350	4	16
3	Боковина	Side	Wenge	Ash light	Oak gold	192x446	2	2
	Боковина левая	Side left				370x446	1	3
	Боковина правая	Side right				370x446	1	4
	Боковина левая	Side left				370x430	1	5
	Боковина правая	Side right				370x430	1	6
	Крышка нижняя	Top low				1000x446	1	9
	Крышка верхняя	Top high				1000x446	1	10
	Крышка верхняя	Top high				1000x446	1	11
	Крышка нижняя	Top low				1000x430	1	12
	Вязка	Connecting element				968x446	1	15
	ХДФ	Back element				440x400	2	24
	ХДФ	Back element				996x220	1	25
	ХДФ	Back element				996x384	1	26
	ХДФ	Back element				956x396	2	27
4	Боковина	Side	Wenge	Ash light	Oak gold	162x446	1	1
	Вязка	Connecting element				800x184	1	13
	Вязка	Connecting element				1000x184	1	14
	Задник	Back element				1000x595	1	17
	Задник	Back element				800x196	1	18
	Детали ящика	Side drawers				134x400	4	19
	Детали ящика	Side drawers				134x408	4	20

Продается отдельно/Sold separately

Упак/ Pack	Наименование	Description	Décor		Размер/ Size, mm	Кол-во/ Quantity	№
			White gl	Cappuccino gl			
1	Фасад МДФ левый	Door element left	White gl	Cappuccino gl	150x396	2	21
	Фасад МДФ правый	Door element right			150x396	2	30
	Панель	Drawer panel			496x224	2	22
	Створка	Door			496x402	2	23
2	Стеклополка	Glass shelves	прозрачное/transparent		358x326	4	28
	Стекло	Glass	прозрачное/transparent		708x362	2	29
	Стеклополка	Glass shelves	прозрачное/transparent		1000x178	2	8

(PL) Instrukcja montażu

(CZ) Návod k montáži

(D) Montageanleitung

(GB) Assembly instruction

(F) Model d'emploi

(HU) Szerelési útmutató

(I) Istruzione di montaggio

(NL) Handleiding voor de montage



(RU) Инструкция по монтажу

(RO) Instrucțiuni de montare

(SK) Návod k montáži

(TR) Montaj talimatı

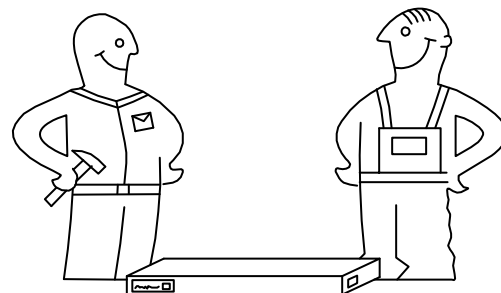
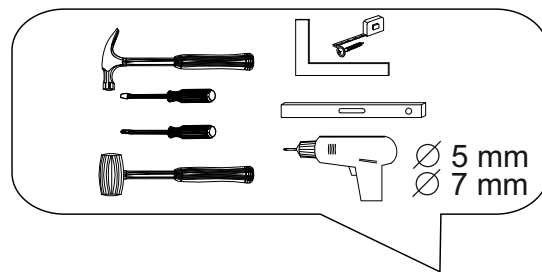





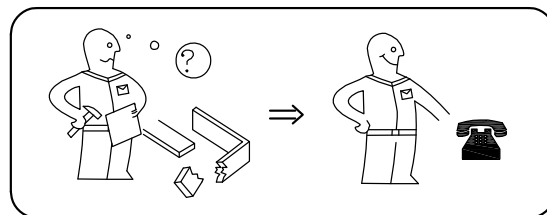
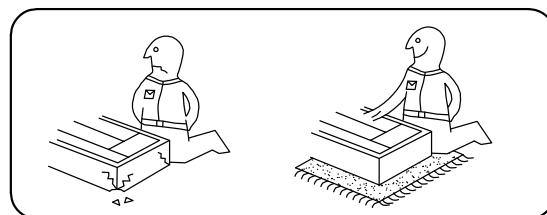



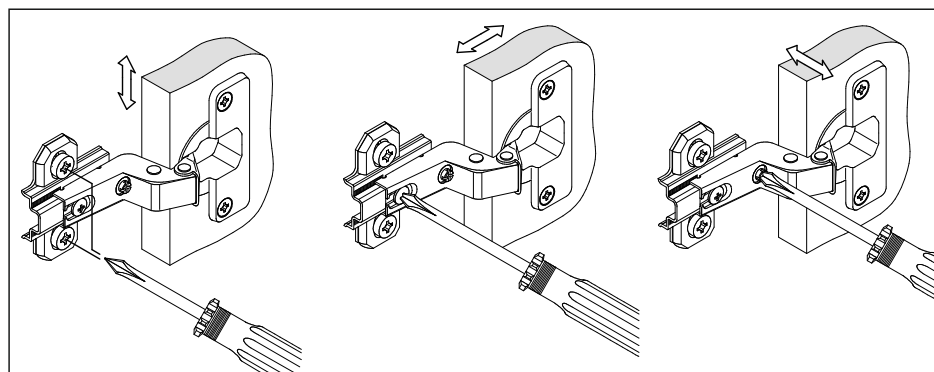
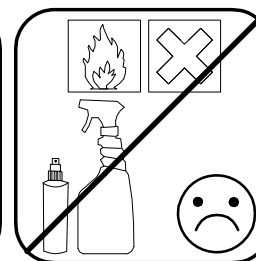
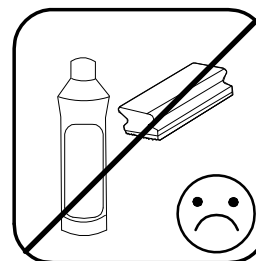
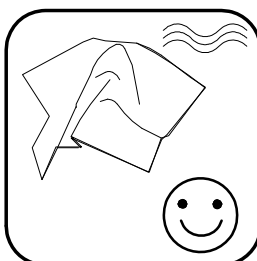
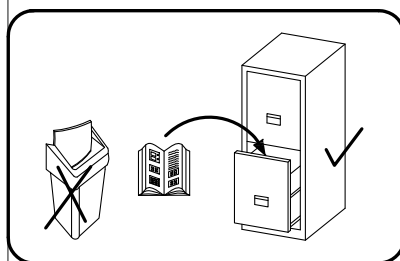

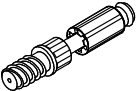

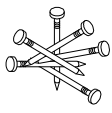
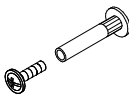
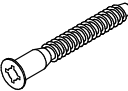
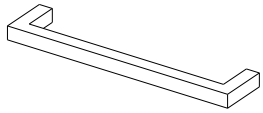



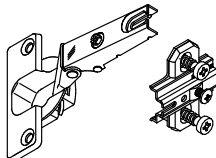
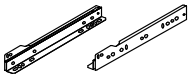

Uwaga • Upozornění • Achtung • Attention • Caution • Figyelem
Attenzione • Opgelet • Внимание • Atenție • Upozornenie • Dikkat

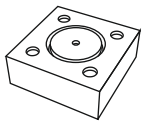
PL	Czyszczenie należy wykonać wyłącznie za pomocą ściereczki lub lekko nawilżonego ręcznika. Nie stosować środków czyszczących do szorowania.
CZ	Čistení je nutné vykonávat výhradně pomocí utěrky nebo lehce navlhlého ručníku. Nepoužívejte čisticí prostředky obsahující abrazivní částice.
D	Bitte nur mit einem Staubtuch oder leicht feuchtem Lappen reinigen. Keine scheuernden Putzmittel verwenden.
GB	Please only clean with a duster or a damp cloth. Do not use any abrasive cleaners.
F	Le nettoyage se fait uniquement à l'aide d'un torchon ou d'une serviette légèrement mouillée.
HU	A tisztítás kizárólag törölrőruha vagy enyhén nedvesített törölköző segítségével végezhető. Súroló hatású tisztítószereket nem szabad használni.
I	Pulire esclusivamente con un panno o un asciugamano umido.
NL	Reinig alleen met een stofdoek of een lichtjes vochtige doek. Gebruik geen schurende poetsmiddelen.
RU	Очищайте от пыли тряпкой или слегка влажной ветошью. Не допускается применение чистящих средств, не предназначенных для ухода за мебелью.
RO	Curățarea trebuie efectuată numai cu o cârpă sau cu un prosop ușor umezit. Nu utilizați agenți de curățare abrazivi.
SK	Čistení je nutné vykonávať výhradne pomocou utierky alebo ľahko zvlhnutým ručníkom. Nepoužívajte čistiace prostriedky obsahujúce abrazívni častice.
TR	Lütfen sadece bir toz bezile veya hafif nemli yumuşak bir bezle siliniz. Aşındırıcı temizlik malzemeleri kullanmayınız.

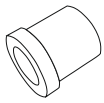

Karta serwisowa • Servisní list • Service Karte • Service card • Carte de service • Szervizkártya
Scheda di servizio • Service kaart • Сервисная карта • Fisa service • Servisný list • Servis karti

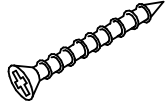
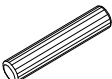

1		2		73		48	2x20	9	
									
38 x		38 x		38 x		60 x		6 x	
5	7x50	126	C42 128 mm	72		6	6,3x10,5	53	
									
24 x		6 x		24 x		24 x		4 x	
91	A	24	400 mm	18	3,5x15	15		41	
									
8 x		2 x		46 x		1 x		16 x	
38		70	d5	21		14	3,5x30	31	
									
9 x		8 x		12 x		9 x		5 x	
3		10	3,5x25	7	8x30	40			
									
9 x		16 x		8 x		4 x			

4

