

## Комод АНТАЛИЯ 1200/ Chest of drawers ANTALYA 1200

Код ТН ВЭД ЕАЭС

9403 60 100 9  
9403 60 900 9

отрезать  
и приклеить

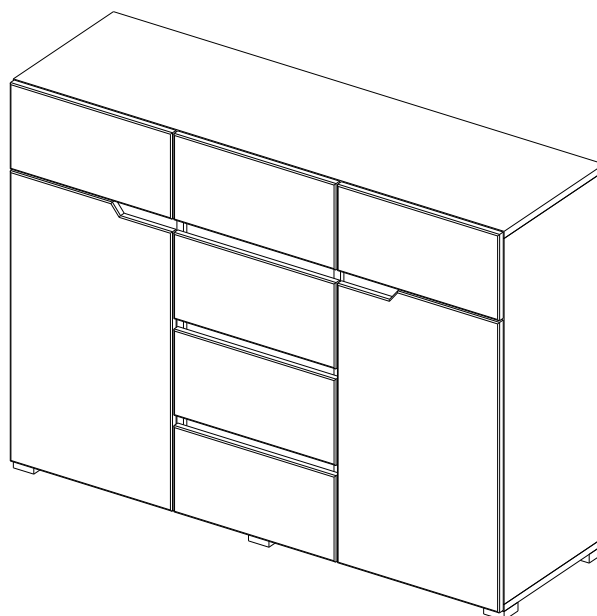

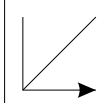
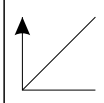
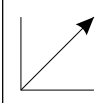
|   |   |   |
|---|---|---|
|  |  |  |
| 1200  | 884   | 376   |

### Комплектовочная ведомость/Set package sheet

| Упаковка/<br>Pack | Наименование    | Description                  | Décor                 |                         |                       | Размер/<br>Size, mm | Кол-во/<br>Quantity | №  |
|-------------------|-----------------|------------------------------|-----------------------|-------------------------|-----------------------|---------------------|---------------------|----|
|                   |                 |                              | Sonoma-<br>Belyj soft | Sonoma -<br>Grafit soft | Wenge -<br>Belyj soft |                     |                     |    |
| 1                 | Фурнитура       | Furniture/Cabinetry hardware | -                     | -                       | -                     | -                   | 1                   | -  |
| 2                 | Боковина левая  | Side left                    | Sonoma                | Sonoma                  | Wenge                 | 660x356             | 1                   | 3  |
|                   | Боковина правая | Side right                   | Sonoma                | Sonoma                  | Wenge                 | 660x356             | 1                   | 4  |
|                   | Крыша           | Top                          | Sonoma                | Sonoma                  | Wenge                 | 1200x360            | 1                   | 7  |
|                   | Крыша           | Top                          | Sonoma                | Sonoma                  | Wenge                 | 1200x356            | 1                   | 8  |
|                   | Полка           | Shelves                      | Sonoma                | Sonoma                  | Wenge                 | 384x356             | 2                   | 10 |
|                   | Деталь ящика    | Side drawers                 | Sonoma                | Sonoma                  | Wenge                 | 100x350             | 12                  | 13 |
|                   | Деталь ящика    | Side drawers                 | Sonoma                | Sonoma                  | Wenge                 | 100x311             | 12                  | 14 |
| 3                 | Боковина левая  | Side left                    | Sonoma                | Sonoma                  | Wenge                 | 832x356             | 1                   | 1  |
|                   | Боковина правая | Side right                   | Sonoma                | Sonoma                  | Wenge                 | 832x356             | 1                   | 2  |
|                   | Боковина левая  | Side left                    | Sonoma                | Sonoma                  | Wenge                 | 156x356             | 2                   | 5  |
|                   | Боковина правая | Side right                   | Sonoma                | Sonoma                  | Wenge                 | 156x356             | 2                   | 6  |
|                   | Вязка           | Connecting element           | Sonoma                | Sonoma                  | Wenge                 | 1168x356            | 1                   | 9  |
|                   | Тяга            | Connecting element           | Sonoma                | Sonoma                  | Wenge                 | 60x368              | 3                   | 11 |
|                   | Тяга            | Connecting element           | Sonoma                | Sonoma                  | Wenge                 | 60x384              | 2                   | 12 |
| 4                 | ДВП             | Back element                 | Sonoma                | Sonoma                  | Wenge                 | 350x343             | 6                   | 18 |
|                   | ДВП             | Back element                 | Sonoma                | Sonoma                  | Wenge                 | 846x405             | 2                   | 19 |
|                   | ДВП             | Back element                 | Sonoma                | Sonoma                  | Wenge                 | 846x384             | 1                   | 20 |
| 5                 | Панель          | Drawer panel                 | Belyj soft            | Grafit soft             | Belyj soft            | 196x396             | 6                   | 15 |
|                   | Створка левая   | Door left                    | Belyj soft            | Grafit soft             | Belyj soft            | 660x396             | 1                   | 16 |
|                   | Створка правая  | Door right                   | Belyj soft            | Grafit soft             | Belyj soft            | 660x396             | 1                   | 17 |

(PL) Instrukcja montażu

(CZ) Návod k montáži

(D) Montageanleitung

(GB) Assembly instruction

(F) Model d'emploi

(HU) Szerelési útmutató

(I) Istruzione di montaggio

(NL) Handleiding voor de montage

(RU) Инструкция по монтажу

(RO) Instrucțiuni de montare

(SK) Návod k montáži

(TR) Montaj talimatı







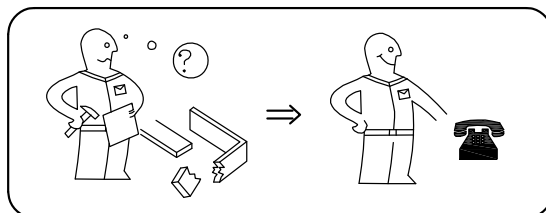
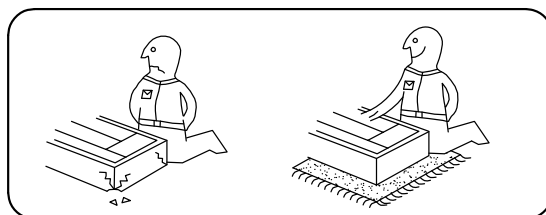



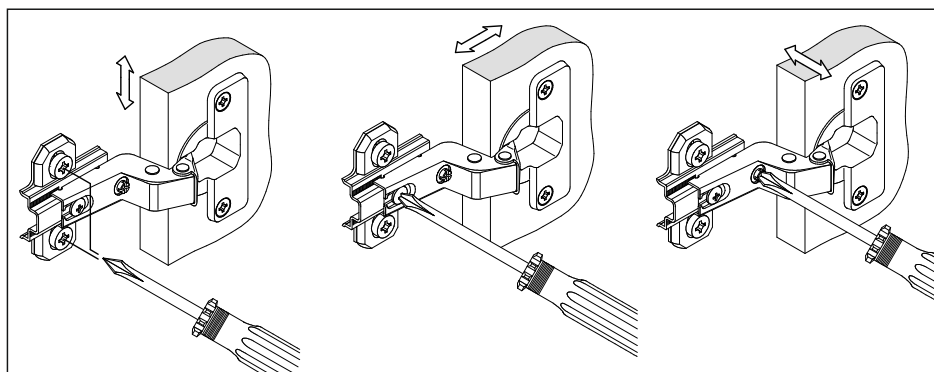
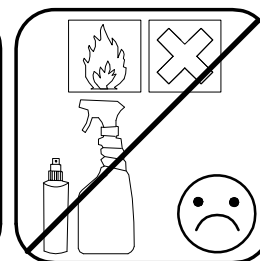
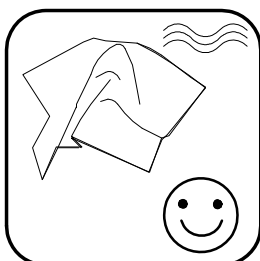
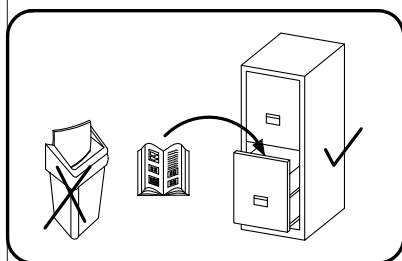

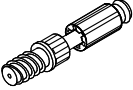
**! Uwaga • Upozornění • Achtung • Attention • Caution • Figyelem • Attenzione • Opgelet • Внимание • Atenție • Upozornenie • Dikkat !**

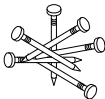

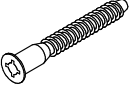
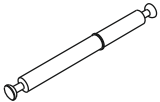
|    |  |
|----|--|
| PL | Czyszczenie należy wykonać wyłącznie za pomocą ściereczki lub lekko nawilżonego ręcznika. Nie stosować środków czyszczących do szorowania.         |
| CZ | Čistění je nutné vykonávat výhradně pomocí utěrky nebo lehce navlhčeného ručníku. Nepoužívejte čisticí prostředky obsahující abrazivní částice.    |
| D  | Bitte nur mit einem Staubtuch oder leicht feuchtem Lappen reinigen. Keine scheuernden Putzmittel verwenden.  |
| GB | Please only clean with a duster or a damp cloth. Do not use any abrasive cleaners.   |
| F  | Le nettoyage se fait uniquement à l'aide d'un torchon ou d'une serviette légèrement mouillée.  |
| HU | A tisztítás kizárólag törölrőruha vagy enyhén nedvesített törölköző segítségével végezhető. Súroló hatású tisztítószereket nem szabad használni.   |
| I  | Pulire esclusivamente con un panno o un asciugamano umido.   |
| NL | Reinig alleen met een stofdoek of een lichtjes vochtige doek. Gebruik geen schurende poetsmiddelen.  |
| RU | Очищайте от пыли тряпкой или слегка влажной ветошью. Не допускается применение чистящих средств, не предназначенных для ухода за мебелью.          |
| RO | Curățarea trebuie efectuată numai cu o cârpă sau cu un prosop ușor umezit. Nu utilizați agenți de curățare abrazivi.                               |
| SK | Čistení je nutné vykonávať výhradne pomocí utierky alebo ľahko zvlhnutým ručníkom. Nepoužívajte čistiace prostriedky obsahujúci abrazívni častice. |
| TR | Lütfen sadece bir toz bezilye veya hafif nemli yumuşak bir bezle siliniz. Aşındırıcı temizlik malzemeleri kullanmayınız.                           |

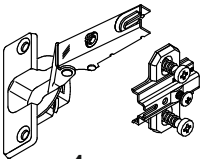
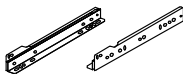

**Karta serwisowa • Servisní list • Service Karte • Service card • Carte de service • Szervizkártya • Scheda di servizio • Service kaart • Сервисная карта • Fisa service • Servisný list • Servis karti**

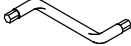
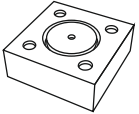

|   |      |   |        |   |        |   |          |   |  |        |
|---|------|---|--------|---|--------|---|----------|---|--|--------|
| 1   |      | 2   |        | 73  |        | 48  | 2x20     | 7   |  | 8x30   |
|  |      |  |        |  |        |  |          |  |  |        |
| 40 x  |      | 48 x  |        | 16 x  |        | 60 x  |          | 8 x   |  |        |
| 5   | 7x50 | 4   |        | 72  |        | 6   | 6,3x10,5 | 14  |  | 3,5x30 |
|  |      |  |        |  |        |  |          |  |  |        |
| 36 x  |      | 4 x   |        | 24 x  |        | 32 x  |          | 6 x   |  |        |
| 91  | A    | 23  | 350 mm | 18  | 3,5x15 | 15  |          | 38  |  |        |
|   |      |  |        |  |        |  |          |  |  |        |
| 4 x   |      | 6 x   |        | 80 x  |        | 1 x   |          | 6 x   |  |        |

|   |  |   |  |
|---|--|---|--|
| 45  |  | 39  |  |
|  |  |  |  |
| 10 x  |  | 8 x   |  |

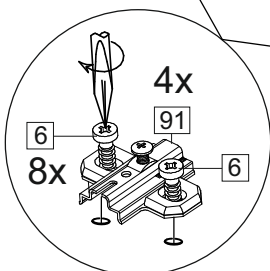
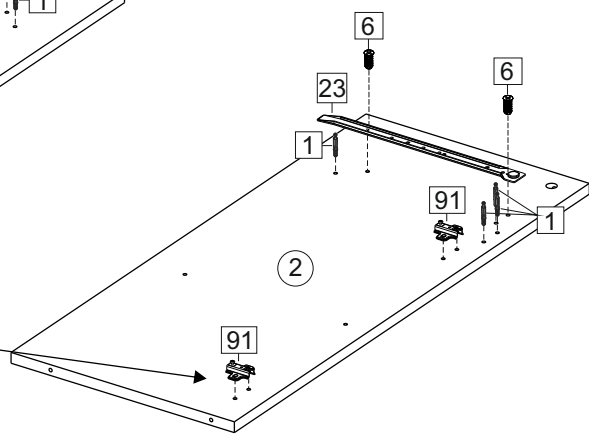
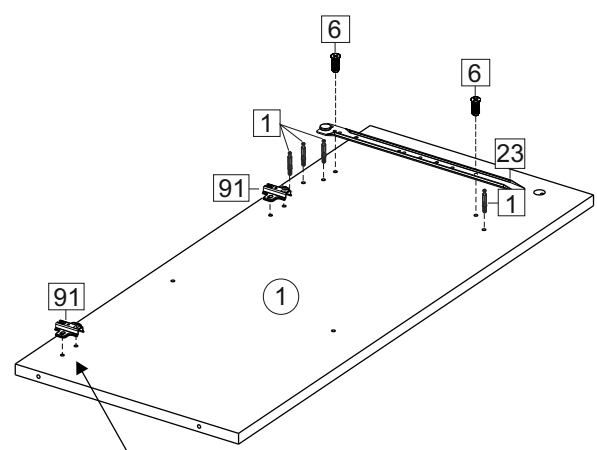
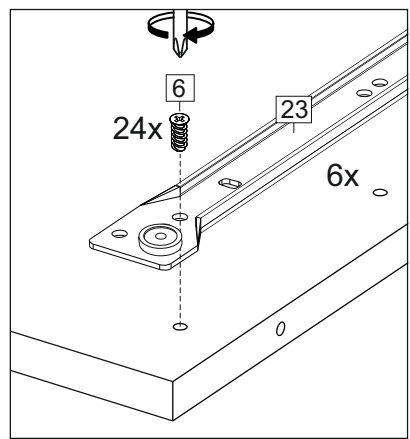
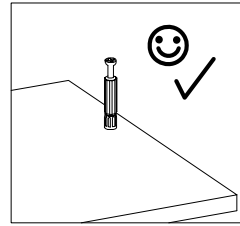
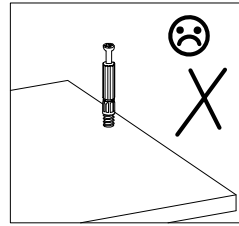
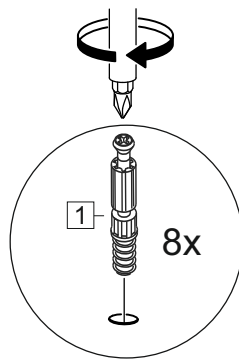

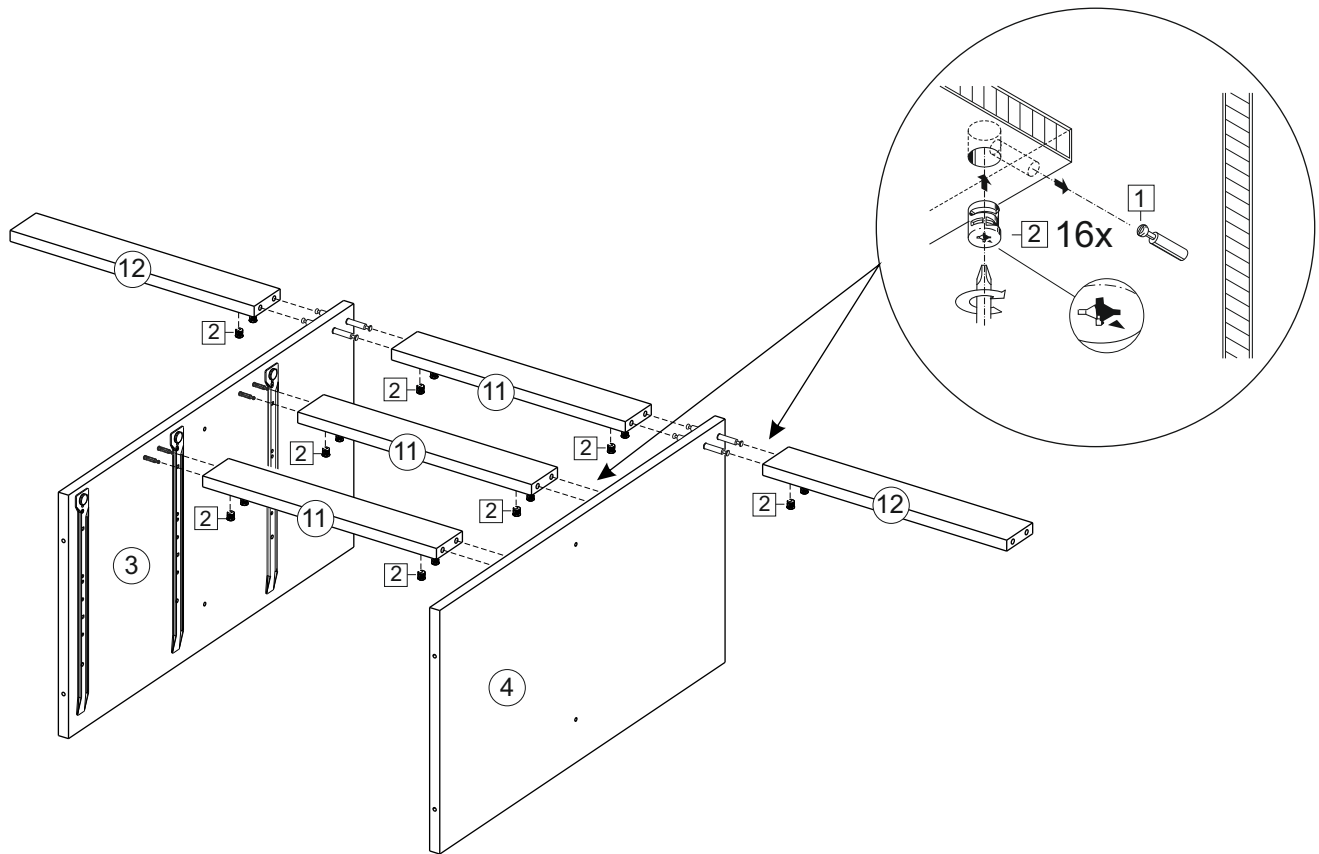
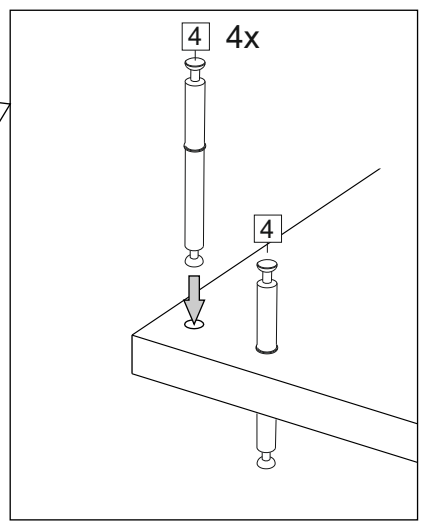
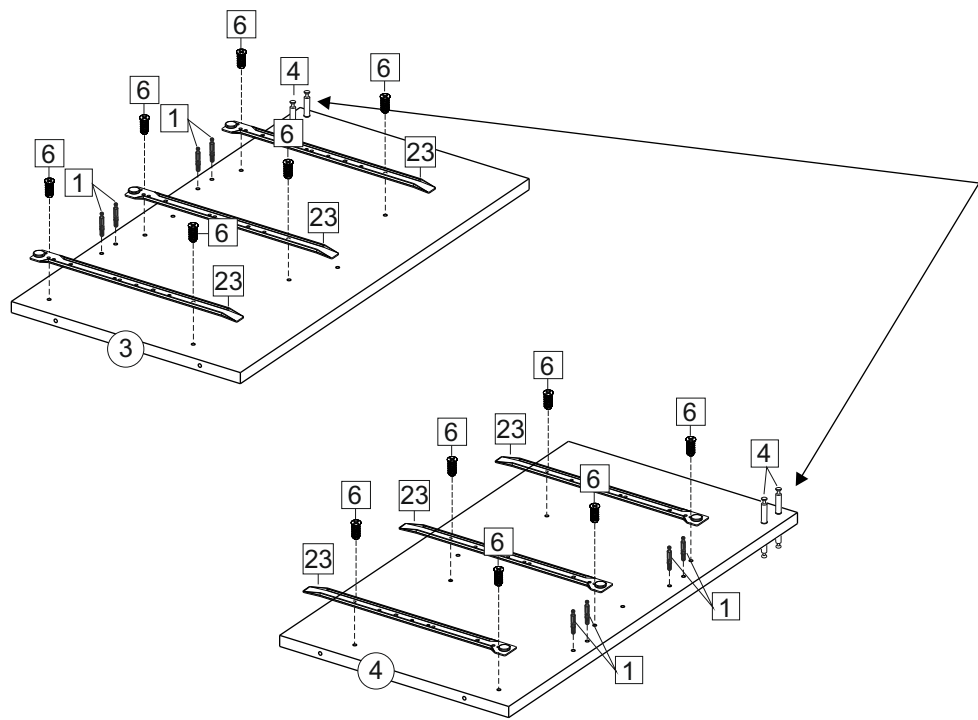
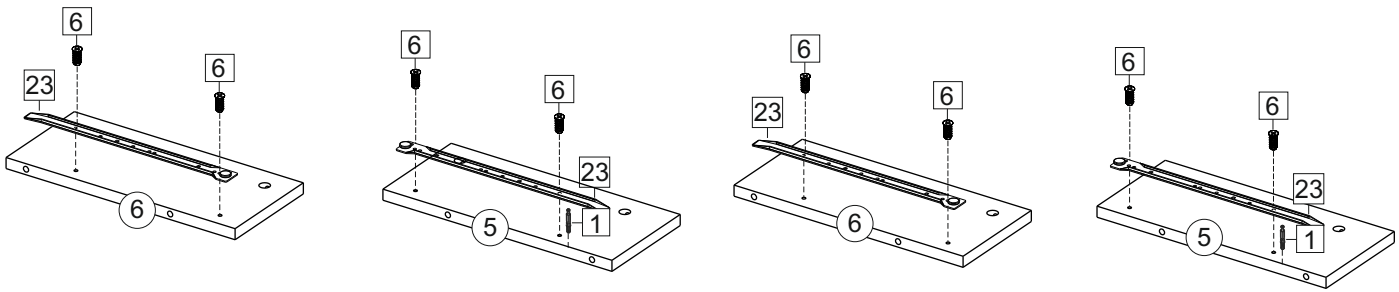

5

