

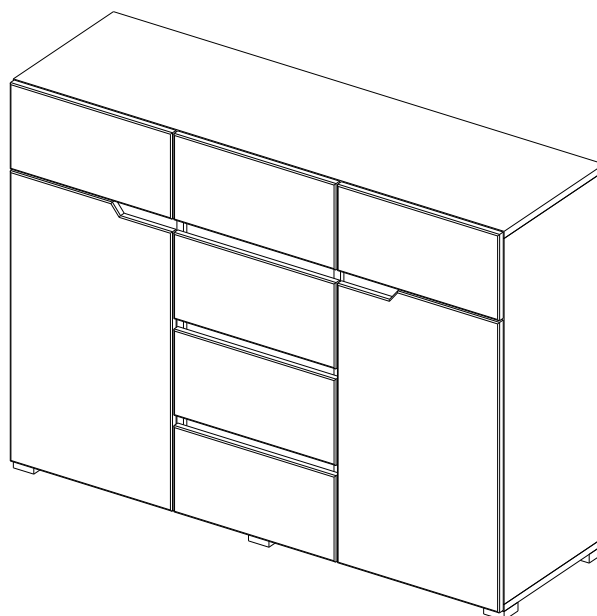



Комод АНТАЛИЯ 1200/ Chest of drawers ANTALYA 1200

Код ТН ВЭД ЕАЭС

9403 60 100 9
9403 60 900 9

отрезать
и приклеить



		
1200	884	376

Комплектовочная ведомость/Set package sheet

Упаковка/ Pack	Наименование	Description	Décor			Размер/ Size, mm	Кол-во/ Quantity	№
			Sonoma- Belyj soft	Sonoma - Grafit soft	Wenge - Belyj soft			
1	Фурнитура	Furniture/Cabinetry hardware	-	-	-	-	1	-
2	Боковина левая	Side left	Sonoma	Sonoma	Wenge	660x356	1	3
	Боковина правая	Side right	Sonoma	Sonoma	Wenge	660x356	1	4
	Крыша	Top	Sonoma	Sonoma	Wenge	1200x360	1	7
	Крыша	Top	Sonoma	Sonoma	Wenge	1200x356	1	8
	Полка	Shelves	Sonoma	Sonoma	Wenge	384x356	2	10
	Деталь ящика	Side drawers	Sonoma	Sonoma	Wenge	100x350	12	13
	Деталь ящика	Side drawers	Sonoma	Sonoma	Wenge	100x311	12	14
3	Боковина левая	Side left	Sonoma	Sonoma	Wenge	832x356	1	1
	Боковина правая	Side right	Sonoma	Sonoma	Wenge	832x356	1	2
	Боковина левая	Side left	Sonoma	Sonoma	Wenge	156x356	2	5
	Боковина правая	Side right	Sonoma	Sonoma	Wenge	156x356	2	6
	Вязка	Connecting element	Sonoma	Sonoma	Wenge	1168x356	1	9
	Тяга	Connecting element	Sonoma	Sonoma	Wenge	60x368	3	11
	Тяга	Connecting element	Sonoma	Sonoma	Wenge	60x384	2	12
4	ДВП	Back element	Sonoma	Sonoma	Wenge	350x343	6	18
	ДВП	Back element	Sonoma	Sonoma	Wenge	846x405	2	19
	ДВП	Back element	Sonoma	Sonoma	Wenge	846x384	1	20
5	Панель	Drawer panel	Belyj soft	Grafit soft	Belyj soft	196x396	6	15
	Створка левая	Door left	Belyj soft	Grafit soft	Belyj soft	660x396	1	16
	Створка правая	Door right	Belyj soft	Grafit soft	Belyj soft	660x396	1	17

(PL) Instrukcja montażu

(CZ) Návod k montáži

(D) Montageanleitung

(GB) Assembly instruction

(F) Model d'emploi

(HU) Szerelési útmutató

(I) Istruzione di montaggio

(NL) Handleiding voor de montage



(RU) Инструкция по монтажу

(RO) Instrucțiuni de montare

(SK) Návod k montáži

(TR) Montaj talimatı











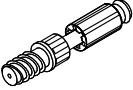

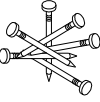
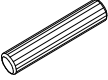
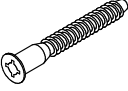
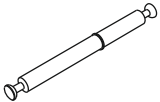
⚠ Uwaga • Upozornění • Achtung • Attention • Caution • Figyelem • Attenzione • Opgelet • Внимание • Atenție • Upozornenie • Dikkat ⚠	
PL	Czyszczenie należy wykonać wyłącznie za pomocą ściereczki lub lekko nawilżonego ręcznika. Nie stosować środków czyszczących do szorowania.
CZ	Čistění je nutné vykonávat výhradně pomocí utěrky nebo lehce navlhčeného ručníku. Nepoužívejte čisticí prostředky obsahující abrazivní částice.
D	Bitte nur mit einem Staubtuch oder leicht feuchtem Lappen reinigen. Keine scheuernden Putzmittel verwenden.
GB	Please only clean with a duster or a damp cloth. Do not use any abrasive cleaners.
F	Le nettoyage se fait uniquement à l'aide d'un torchon ou d'une serviette légèrement mouillée.
HU	A tisztítás kizárólag törölrőruha vagy enyhén nedvesített törölköző segítségével végezhető. Súroló hatású tisztítószerket nem szabad használni.
I	Pulire esclusivamente con un panno o un asciugamano umido.
NL	Reinig alleen met een stofdoek of een lichtjes vochtige doek. Gebruik geen schurende poetsmiddelen.
RU	Очищайте от пыли тряпкой или слегка влажной ветошью. Не допускается применение чистящих средств, не предназначенных для ухода за мебелью.
RO	Curățarea trebuie efectuată numai cu o cârpă sau cu un prosop ușor umezit. Nu utilizați agenți de curățare abrazivi.
SK	Čistení je nutné vykonávať výhradne pomocou utierky alebo ľahko zvlhnutým ručníkom. Nepoužívajte čistiace prostriedky obsahujúce abrazívni častice.
TR	Lütfen sadece bir toz beziyile veya hafif nemli yumuşak bir bezle siliniz. Aşındırıcı temizlik malzemeleri kullanmayınız.

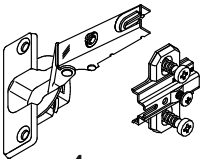
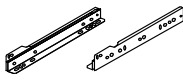

**Karta serwisowa • Servisní list • Service Karte • Service card • Carte de service • Szervizkártya
Scheda di servizio • Service kaart • Сервисная карта • Fisa service • Servisný list • Servis karti**

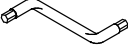
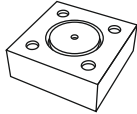

1		2		73		48	2x20	7	8x30
									
40 x		48 x		16 x		60 x		8 x	
5	7x50	4		72		6	6,3x10,5	14	3,5x30
									
36 x		4 x		24 x		32 x		6 x	
91	A	23	350 mm	18	3,5x15	15		38	
									
4 x		6 x		80 x		1 x		6 x	

45		39	
			
10 x		8 x	

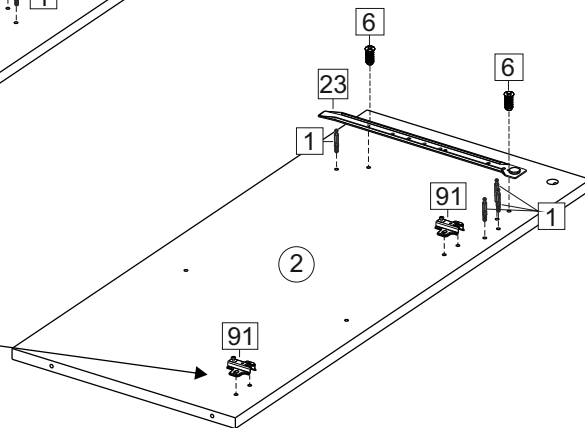
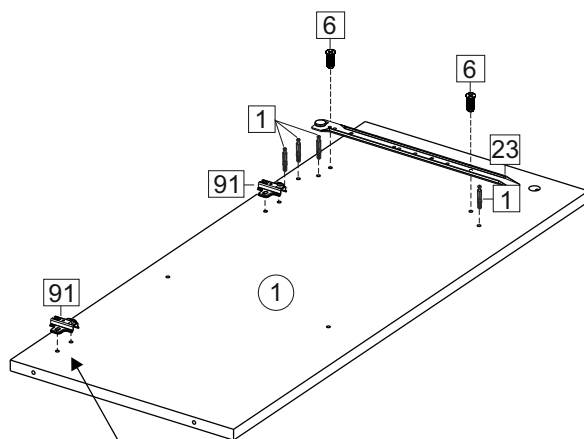
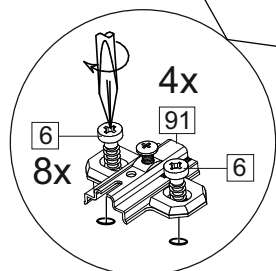
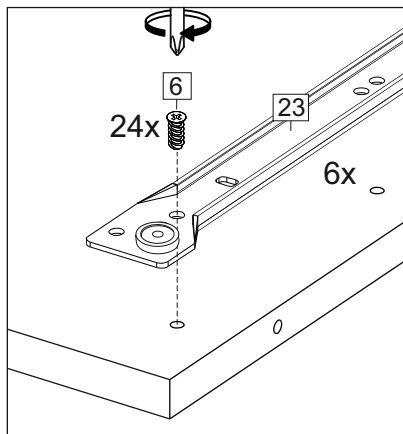
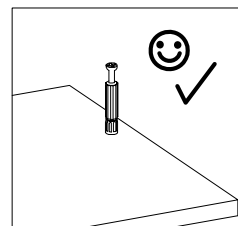
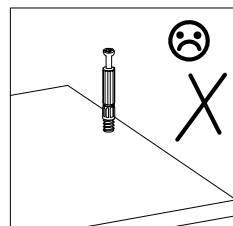
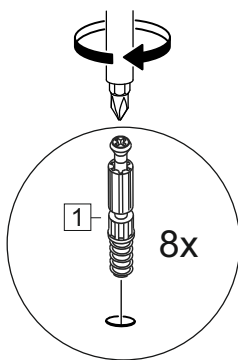

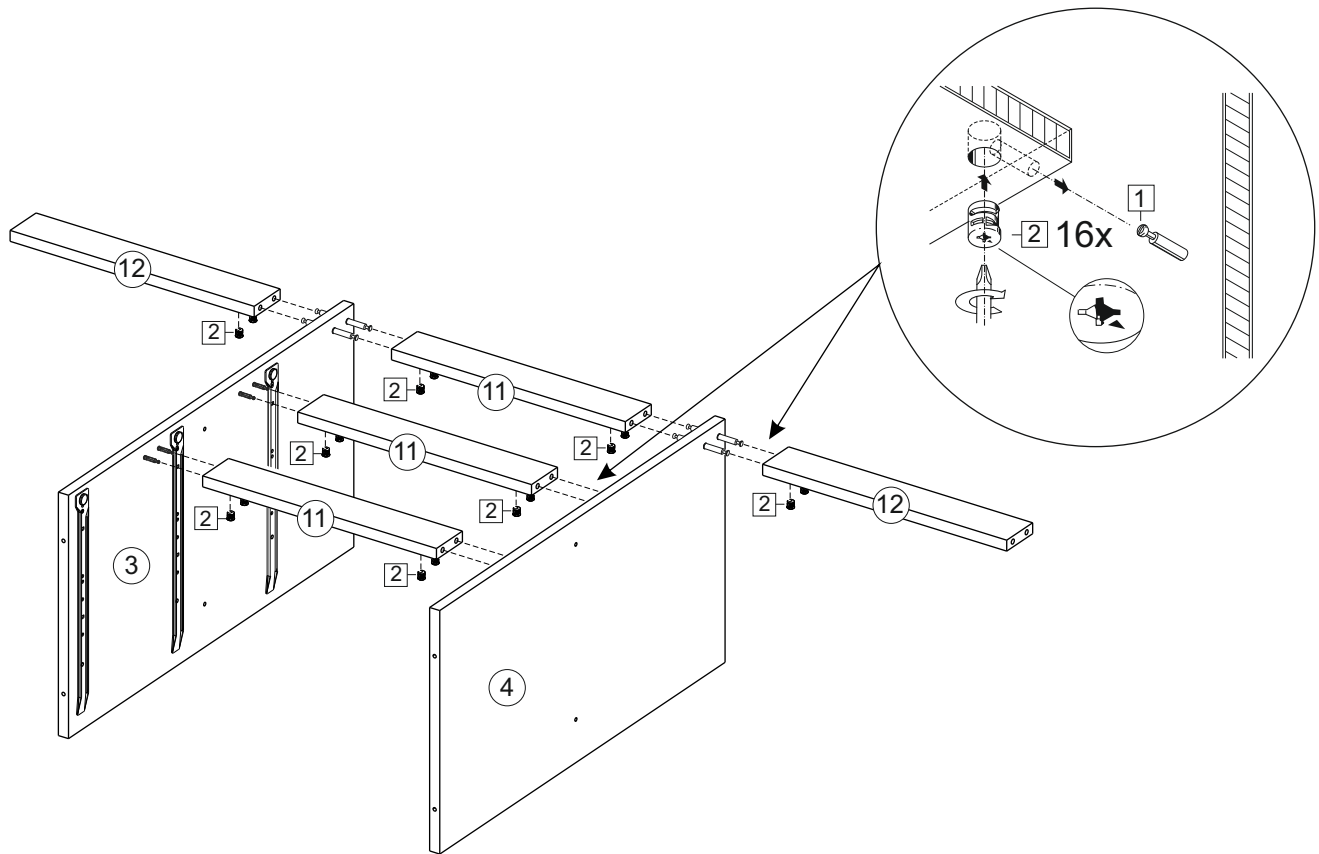
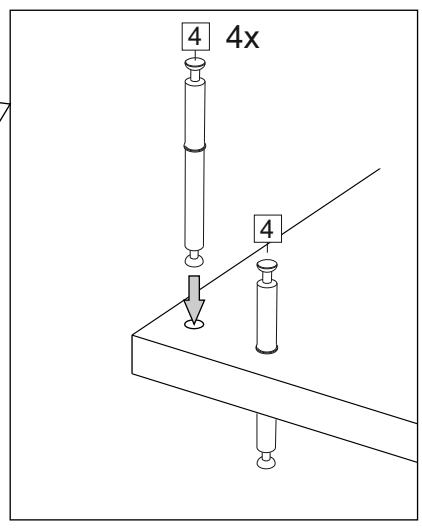
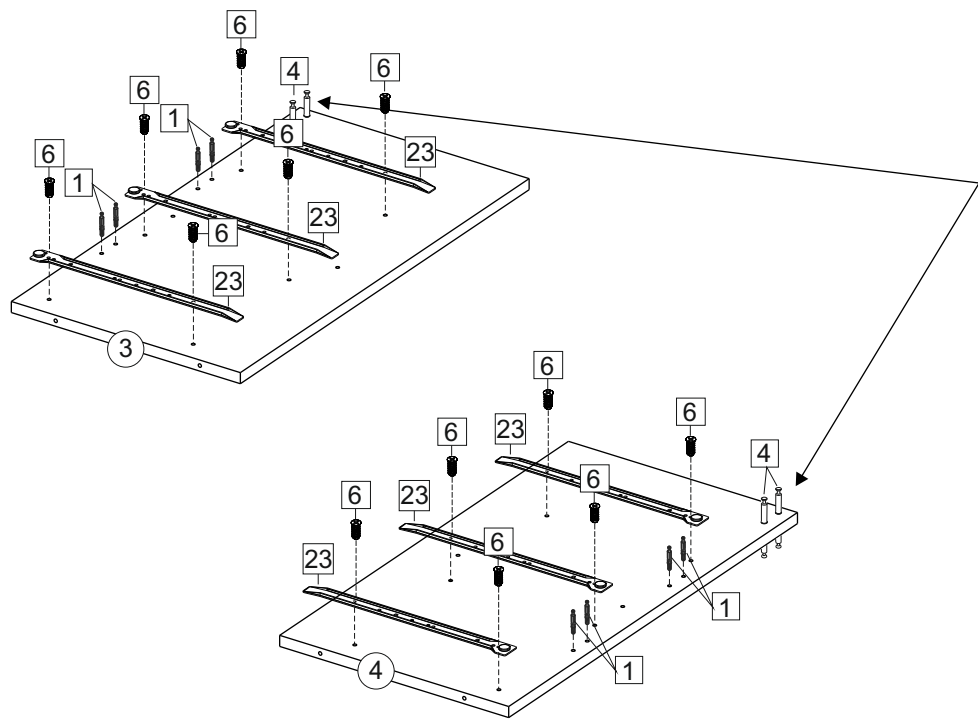
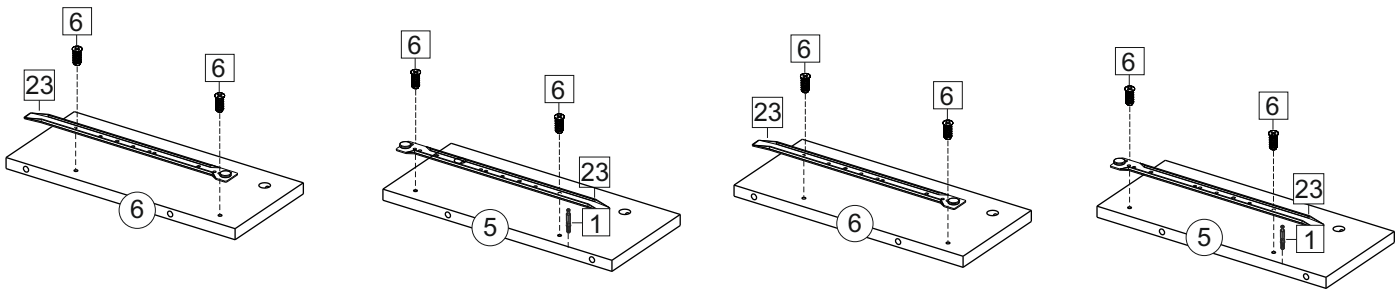

5

