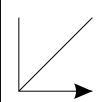
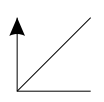
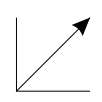

Стол Лайт /Table Light

Код ТН ВЭД ЕАЭС

9403 60 100 1
9403 90 300 0

отрезать
и приклеить

		
1200	750	596

12СКЛ1138

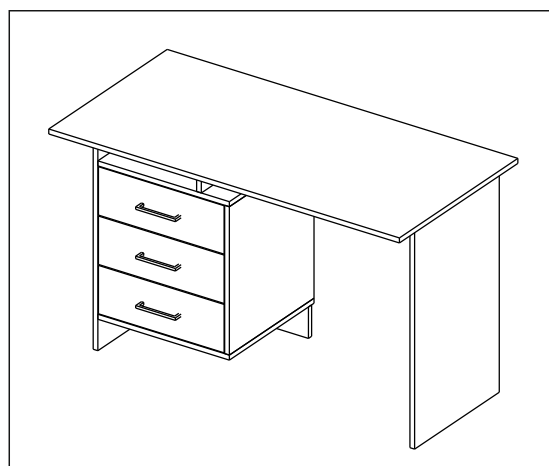
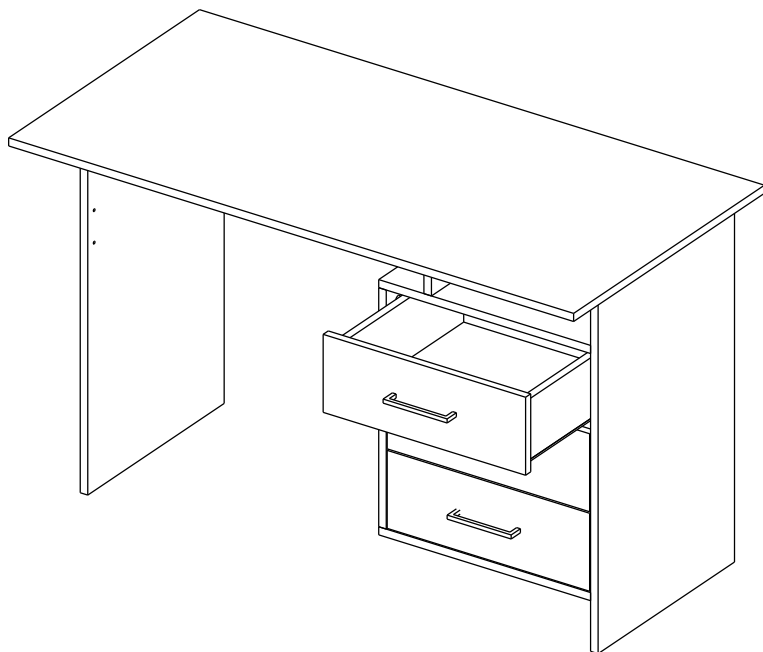

Oak gold - Дуб золотой
White - Белый

Комплектовочная ведомость / Set package sheet

Упак/ Package	Наименование	Description	Цвет детали/ Décor	Размер / Size, mm	Кол-во/ Quantity	№
1	Боковина	Side	White	130x426	1	1
	Боковина	Side	Oak gold	472x426	1	2
	Боковина левая	Side left	White	734x426	1	3
	Боковина правая	Side right	White	734x426	1	4
	Крыша	Top	Oak gold	1200x596	1	7
	Вязка	Connecting element	White	596x294	1	8
	Вязка	Connecting element	White	100x450	1	9
	Панель	Drawer panel	White	154x430	3	12
	ДВП	Back element	White	500x462	1	14
2	Крыша верхняя	Top upper	Oak gold	450x426	1	5
	Крыша нижняя	Top lower	Oak gold	450x426	1	6
	Деталь ящика	Side drawers	White	120x400	6	10
	Деталь ящика	Side drawers	White	120x377	6	11
	ДВП	Back element	White	400x409	3	13
	Фурнитура(Furniture/Cabinetry hardware)		-	-	-	-

(PL) Instrukcja montażu

(CZ) Návod k montáži

(D) Montageanleitung

(GB) Assembly instruction

(F) Model d'emploi

(HU) Szerelési útmutató

(I) Istruzione di montaggio

(NL) Handleiding voor de montage



(RU) Инструкция по монтажу

(RO) Instrucțiuni de montare

(SK) Návod k montáži

(TR) Montaj talimatı

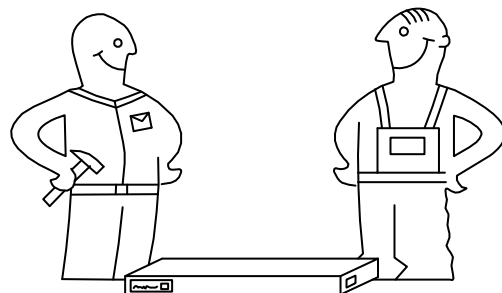
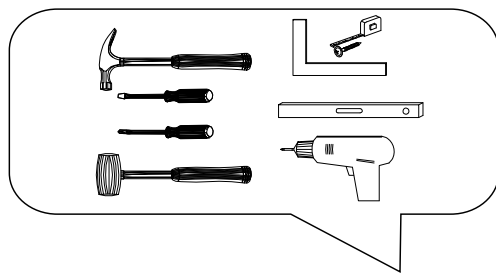





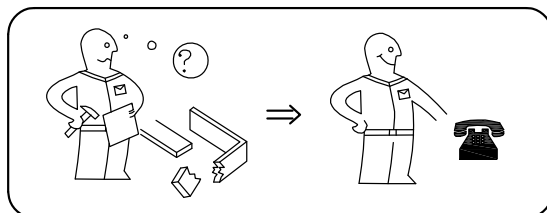
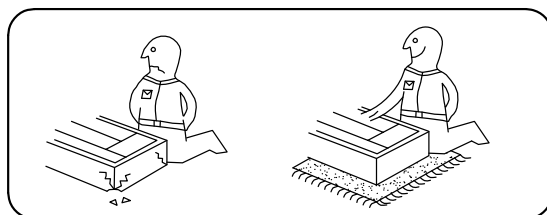

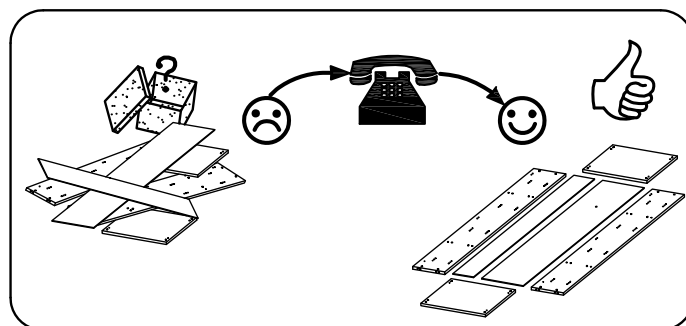
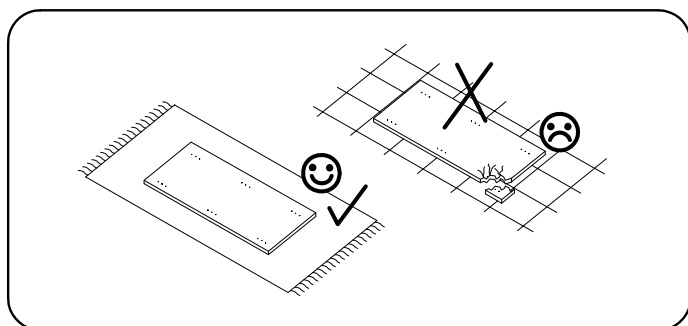
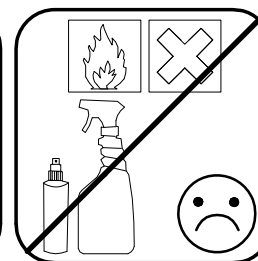
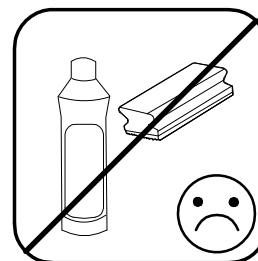
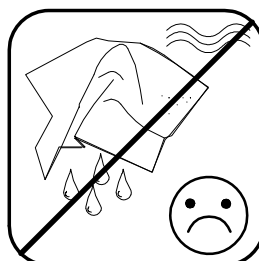
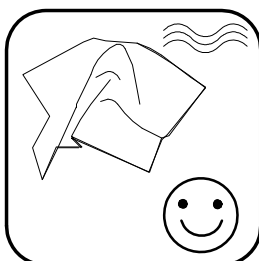
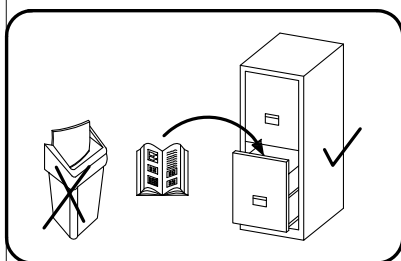

⚠ Uwaga • Upozornění • Achtung • Attention • Caution • Figyelem • Attenzione • Opgelet • Внимание • Atenție • Upozornenie • Dikkat ⚠

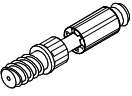
PL	Czyszczenie należy wykonać wyłącznie za pomocą ściereczki lub lekko nawilżonego ręcznika. Nie stosować środków czyszczących do szorowania.
CZ	Čistění je nutné vykonávat výhradně pomocí utěrky nebo lehce navlhčeného ručníku. Nepoužívejte čisticí prostředky obsahující abrazivní částice.
D	Bitte nur mit einem Staubtuch oder leicht feuchtem Lappen reinigen. Keine scheuernden Putzmittel verwenden.
GB	Please only clean with a duster or a damp cloth. Do not use any abrasive cleaners.
F	Le nettoyage se fait uniquement à l'aide d'un torchon ou d'une serviette légèrement mouillée.
HU	A tisztítás kizárólag törölrőruha vagy enyhén nedvesített törölköző segítségével végezhető. Súroló hatású tisztítószereket nem szabad használni.
I	Pulire esclusivamente con un panno o un asciugamano umido.
NL	Reinig alleen met een stofdoek of een lichtjes vochtige doek. Gebruik geen schurende poetsmiddelen.
RU	Очищайте от пыли тряпкой или слегка влажной ветошью. Не допускается применение чистящих средств, не предназначенных для ухода за мебелью.
RO	Curățarea trebuie efectuată numai cu o cârpă sau cu un prosop ușor umezit. Nu utilizați agenți de curățare abrazivi.
SK	Čistení je nutné vykonávať výhradne pomocí utierky alebo ľahko zvlhnutým ručníkom. Nepoužívajte čistiaci prostriedky obsahujúci abrazívni častice.
TR	Lütfen sadece bir toz bezilye veya hafif nemli yumuşak bir bezle siliniz. Aşındırıcı temizlik malzemeleri kullanmayınız.

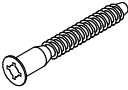

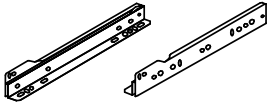
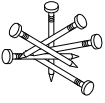
Karta serwisowa • Servisní list • Service Karte • Service card • Carte de service • Szervizkártya • Scheda di servizio • Service kaart • Сервисная карта • Fisa service • Servisný list • Servis karti

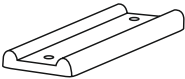
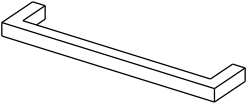
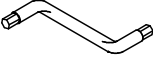

1		2		5	7x50	6	6,3x10,5	18	3,5x15
									
24 x		24 x		22 x		12 x		36 x	
24	400 mm	48	2x20	71	∅ 5 mm	72		73	
									
3 x		12 x		8 x		12 x		20 x	
76		126	C42 128 mm	15					
									
6 x		3 x		1 x					

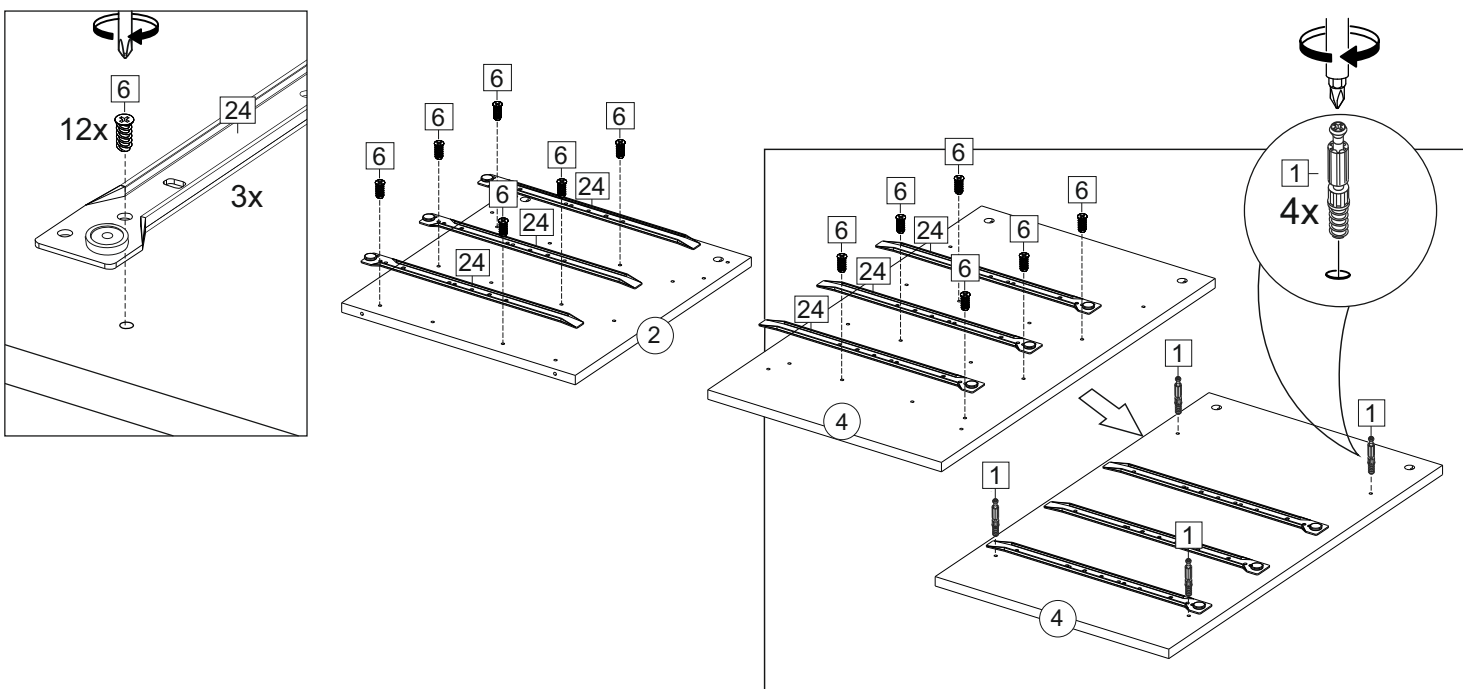
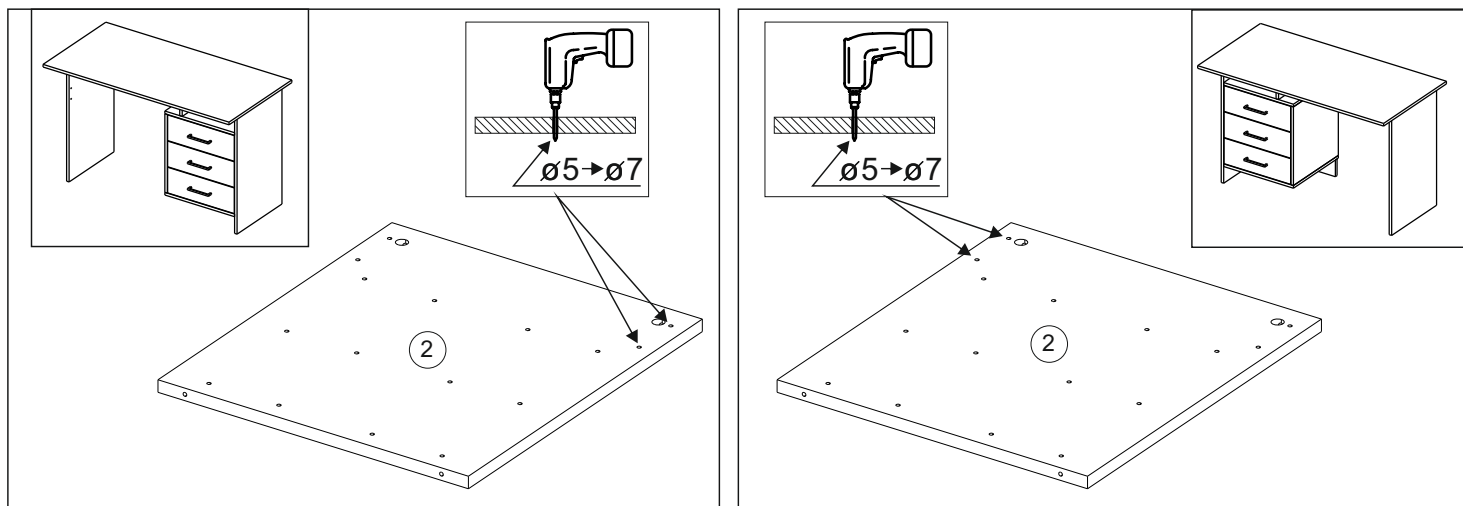

4

