



Шкаф/wardrobe 800; 900; 1000/ 2

Код ТН ВЭД ЕАЭС

9403 60 100 1
9403 90 300 0

отрезать
и приклеить

		
800	2072	570
900	2072	570
1000	2072	570

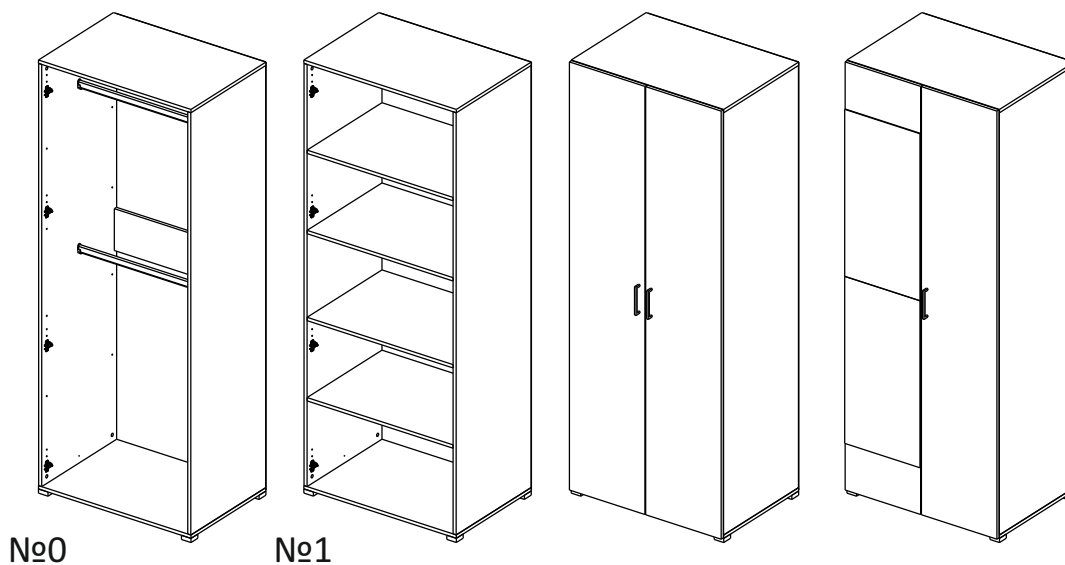

35A2Ф / 2982

Комплектовочная ведомость / Set package sheet

Упак/ Package	Наименование	Description	Размер / Size, mm			Кол-во/ Quantity	№
			800 mm	900 mm	1000 mm		
1	Фурнитура	Furniture/Cabinetry hardware	-	-	-	-	-
2,1	Боковина	Side	549x2020	549x2020	549x2020	2	1
3	Крыша	Top	800x549	900x549	1000x549	2	2
	Тяга	Connecting element	766x200	866x200	966x200	1	3
	Штанга	Wardrobe tube	761 мм	861 мм	961 мм	2	5

Продается отдельно/Sold separately

4	Полки	Shelves	766x549	866x549	966x549	4	10
5	Створка	Door	396x2048	446x2048	496x2048	2	7
	ДВП (клей)	Back element (glue)	2048x396	2048x446	2048x496	2	8
6	Зеркало	Mirror	395x799	445x799	495x799	2	12

(PL) Instrukcja montażu

(CZ) Návod k montáži

(D) Montageanleitung

(GB) Assembly instruction

(F) Model d'emploi

(HU) Szerelési útmutató

(I) Istruzione di montaggio

(NL) Handleiding voor de montage

(RU) Инструкция по монтажу

(RO) Instrucțiuni de montare

(SK) Návod k montáži

(TR) Montaj talimatı









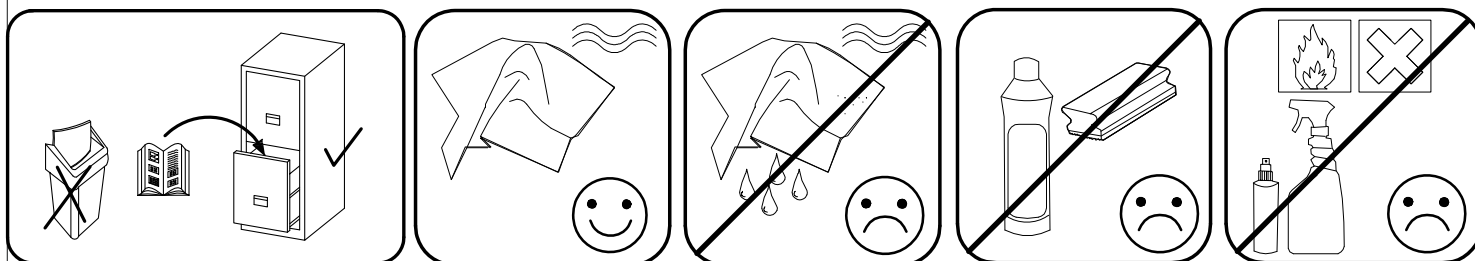

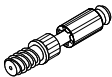



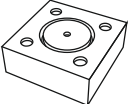
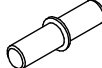

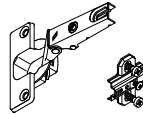
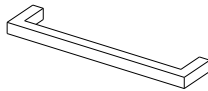
⚠ Uwaga • Upozornění • Achtung • Attention • Caution • Figyelem • Attenzione • Opgelet • Внимание • Atenție • Upozornenie • Dikkat ⚠	
PL	Czyszczenie należy wykonać wyłącznie za pomocą ściereczki lub lekko nawilżonego ręcznika. Nie stosować środków czyszczących do szorowania.
CZ	Čistění je nutné vykonávat výhradně pomocí utěrky nebo lehce navlhčeného ručníku. Nepoužívejte čisticí prostředky obsahující abrazivní částice.
D	Bitte nur mit einem Staubtuch oder leicht feuchtem Lappen reinigen. Keine scheuernden Putzmittel verwenden.
GB	Please only clean with a duster or a damp cloth. Do not use any abrasive cleaners.
F	Le nettoyage se fait uniquement à l'aide d'un torchon ou d'une serviette légèrement mouillée.
HU	A tisztítás kizárólag törölrőruha vagy enyhén nedvesített törölköző segítségével végezhető. Súroló hatású tisztítószerket nem szabad használni.
I	Pulire esclusivamente con un panno o un asciugamano umido.
NL	Reinig alleen met een stofdoek of een lichtjes vochtige doek. Gebruik geen schurende poetsmiddelen.
RU	Очищайте от пыли тряпкой или слегка влажной ветошью. Не допускается применение чистящих средств, не предназначенных для ухода за мебелью.
RO	Curățarea trebuie efectuată numai cu o cârpă sau cu un prosop ușor umezit. Nu utilizați agenți de curățare abrazivi.
SK	Čistení je nutné vykonávať výhradne pomocou utierky alebo ľahko zvlhnutým ručníkom. Nepoužívajte čistiace prostriedky obsahujúce abrazívni častice.
TR	Lütfen sadece bir toz beziyile veya hafif nemli yumuşak bir bezle siliniz. Aşındırıcı temizlik malzemeleri kullanmayınız.



**Karta serwisowa • Servisní list • Service Karte • Service card • Carte de service • Szervizkártya
Scheda di servizio • Service kaart • Сервисная карта • Fisa service • Servisný list • Servis karti**



1		2		6	6,3x10,5	15		18	3,5x15	38	
											
12 x		12 x		16 x		1 x		40 x		4 x	
39	DUPLO	48	2x20	49		91	Hinge A	126	C42 128 mm	71	∅ 5 mm
											
16 x		50 x		4 x		8 x		2 x		32 x	
133	∅ 5 mm	134	∅ 5 mm	73		131		132			
											
32 x		32 x		12 x		12 x		12 x			

77	83	2m
		
1 x		1 x
В упаковке с зеркалом/package Mirror		

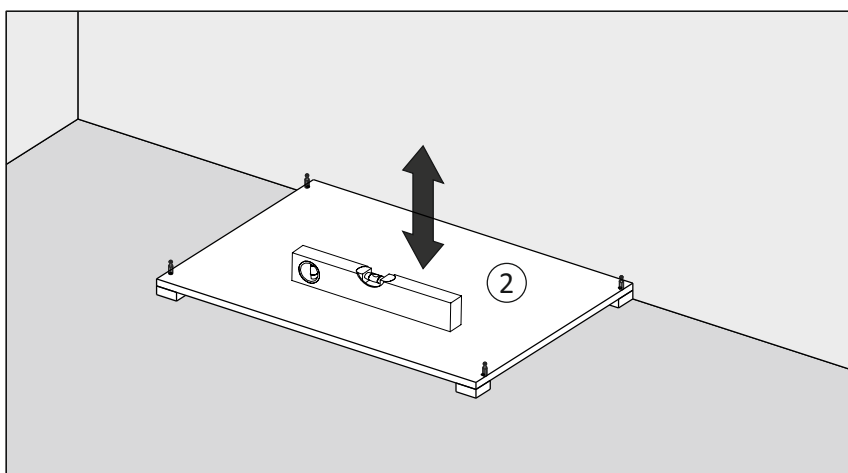
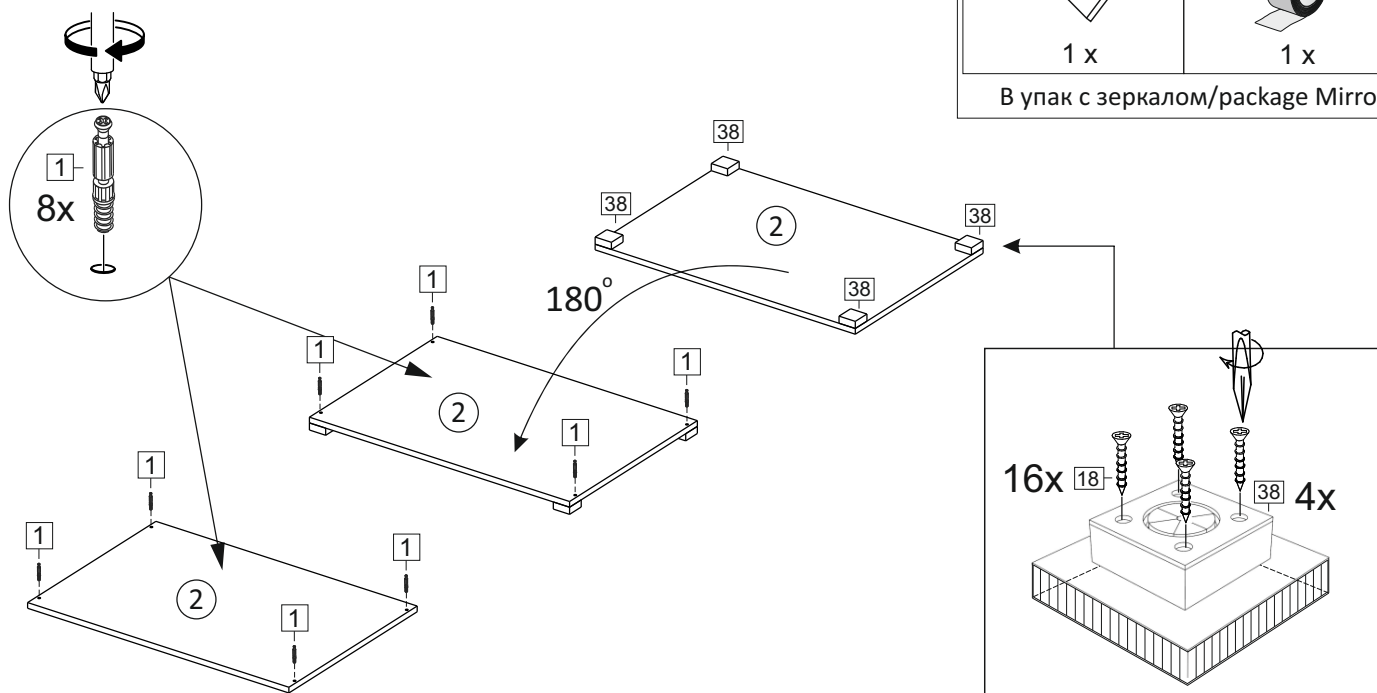

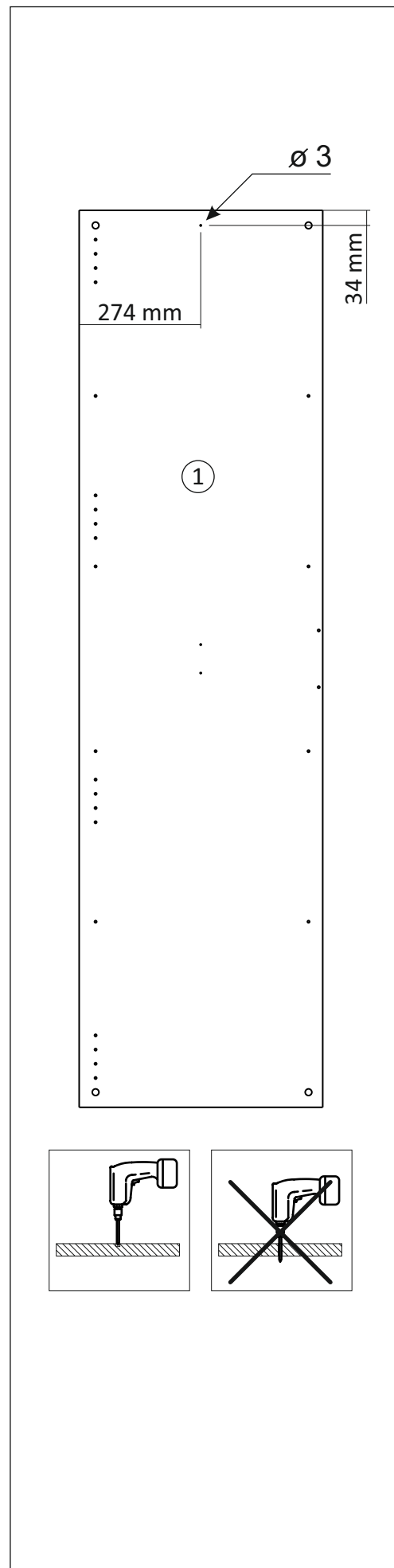
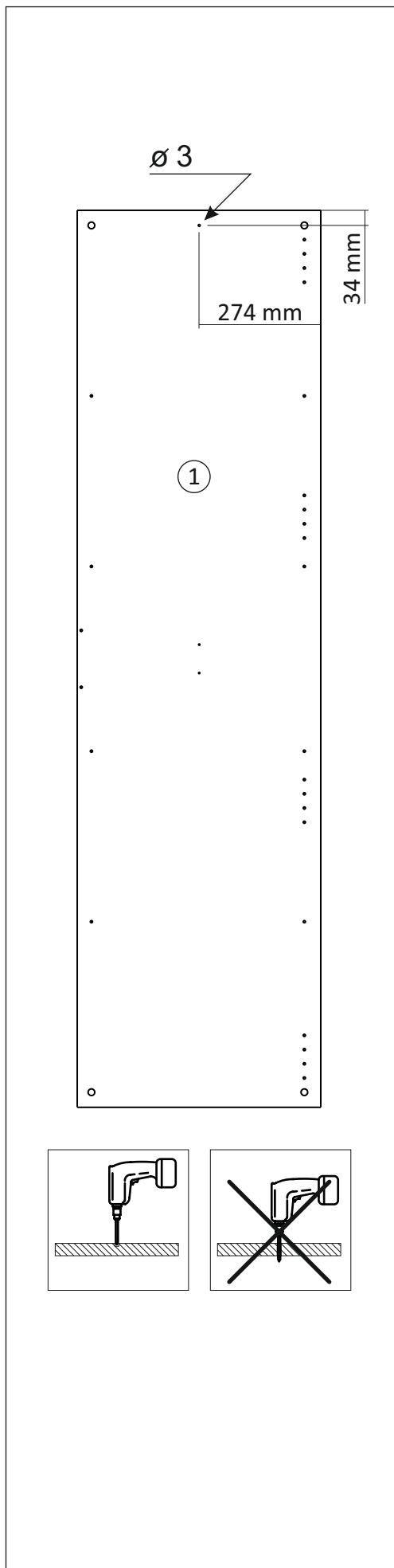

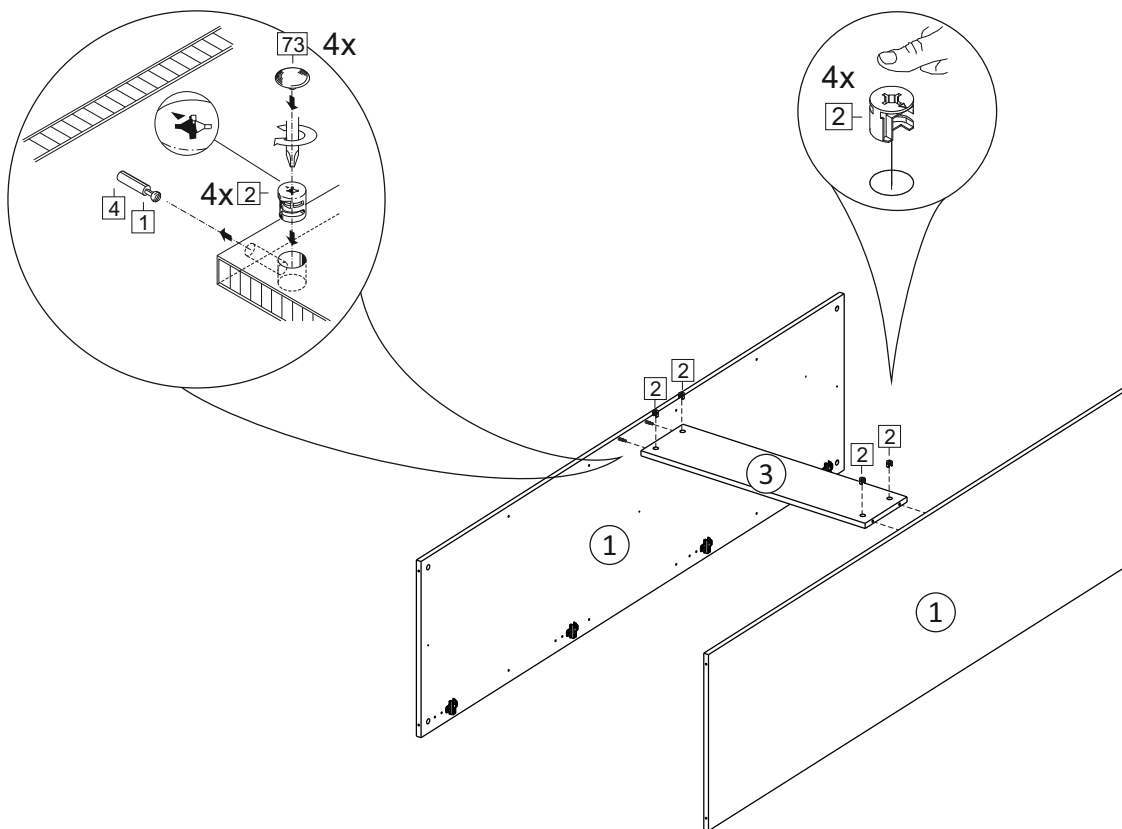
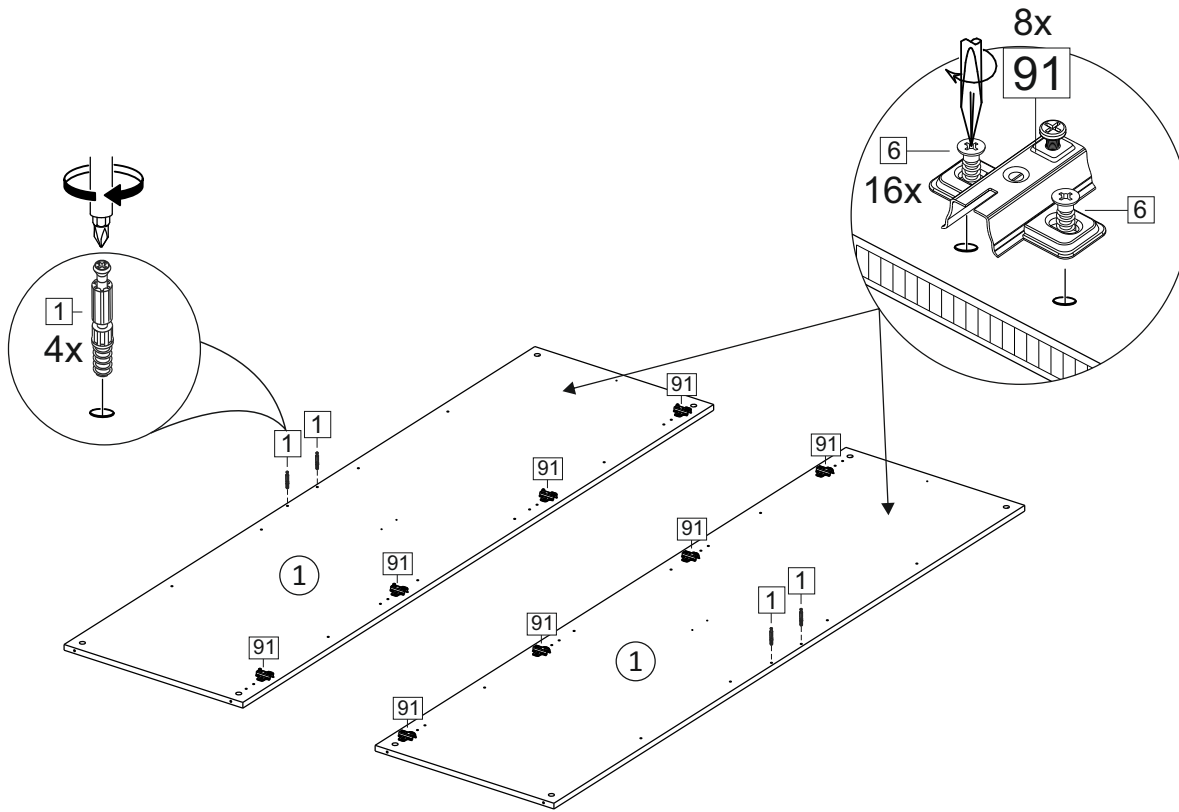

6

