



## Шкаф 900 Лайт / wardrobe 900 Light

Код ТН ВЭД ЕАЭС

9403 60 100 1  
9403 90 300 0

отрезать  
и приклеить

		
900	2052	480

12СКШ / 2915

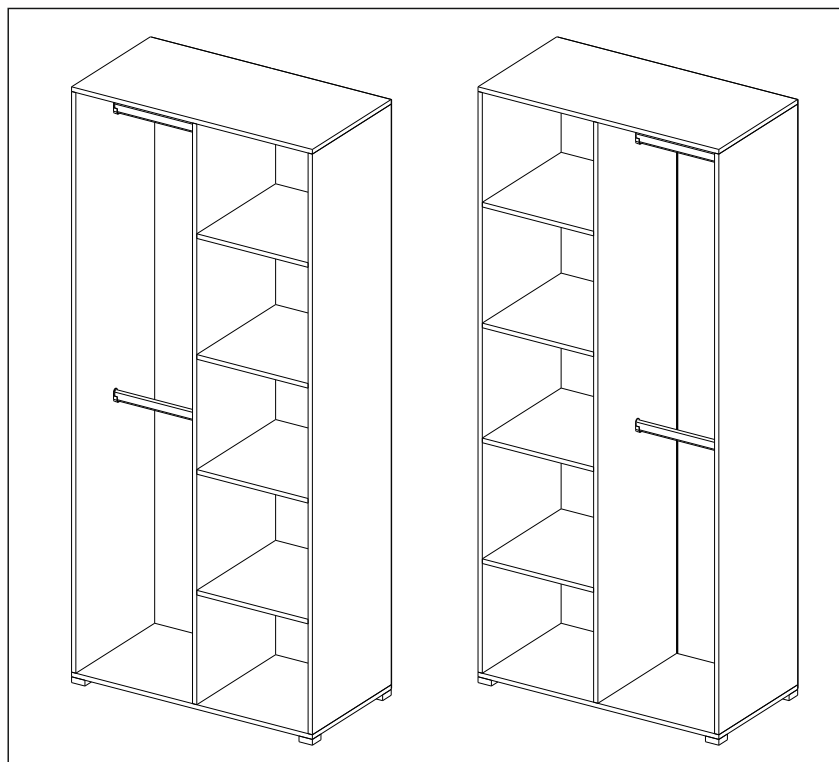
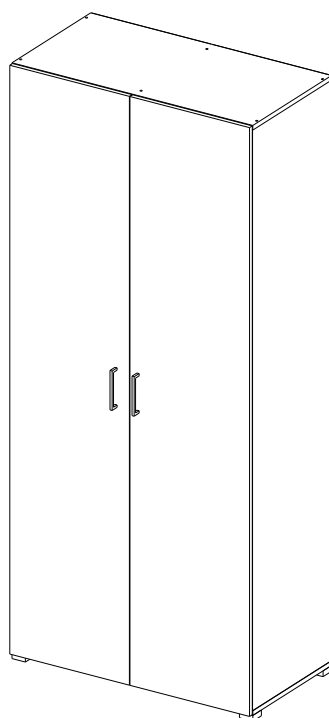

### Комплектовочная ведомость / Set package sheet

Упак/ Package	Наименование	Description	Цвет детали/ Décor	Размер / Size, mm	Кол-во/ Quantity	№
2	Боковина левая	Side left	Oak gold	2000x460	1	1
	Боковина средняя	Side middle	Oak gold	2000x460	1	2
	Боковина правая	Side right	Oak gold	2000x460	1	3
3	Крыша	Top	Oak gold	460x900	2	4
	Вязка	Connecting element	Oak gold	460x416	4	5
	№1 Фурнитура Штанга	Furniture/Cabinetry hardware Wardrobe tube	- -	- 429 mm	- 2	- 8
4	Створка	Door	White	2028x447	2	6
	ХДФ (клей)	Back element	White	2028x447	2	7

Oak gold - Дуб золотой  
White - Белый

(PL) Instrukcja montażu

(CZ) Návod k montáži

(D) Montageanleitung

(GB) Assembly instruction

(F) Model d'emploi

(HU) Szerelési útmutató

(I) Istruzione di montaggio

(NL) Handleiding voor de montage

(RU) Инструкция по монтажу

(RO) Instrucțiuni de montare

(SK) Návod k montáži

(TR) Montaj talimatı

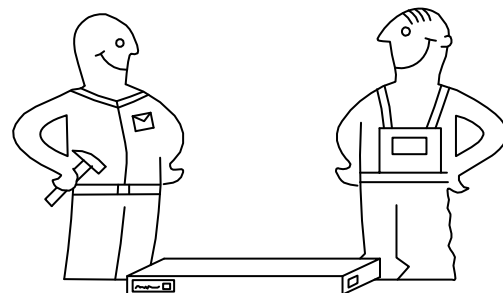
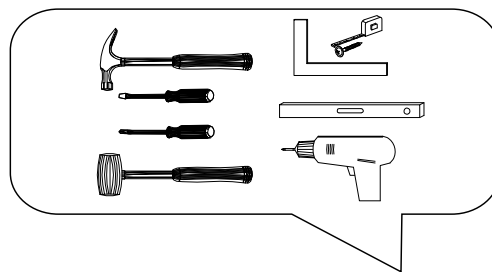



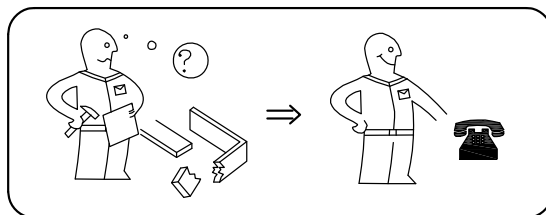
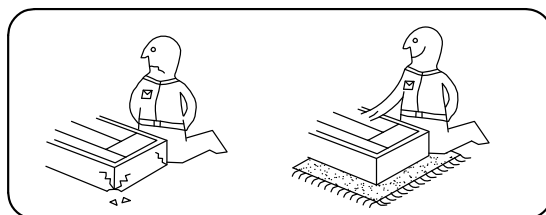



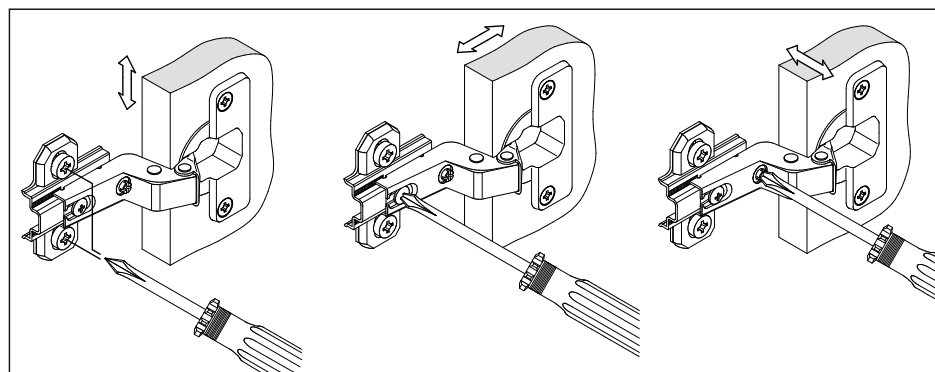
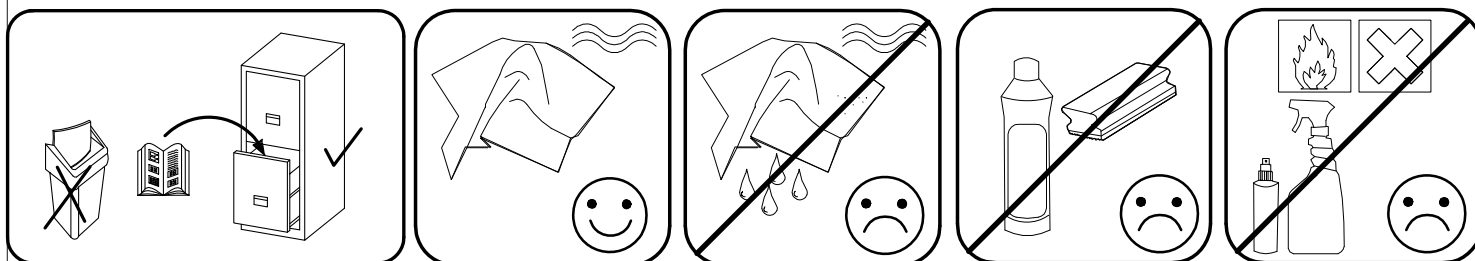

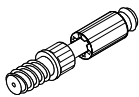

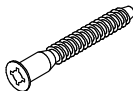
⚠ Uwaga • Upozornění • Achtung • Attention • Caution • Figyelem • Attenzione • Opgelet • Внимание • Atenție • Upozornenie • Dikkat ⚠	
PL	Czyszczenie należy wykonać wyłącznie za pomocą ściereczki lub lekko nawilżonego ręcznika. Nie stosować środków czyszczących do szorowania.
CZ	Čistění je nutné vykonávat výhradně pomocí utěrky nebo lehce navlhčeného ručníku. Nepoužívejte čisticí prostředky obsahující abrazivní částice.
D	Bitte nur mit einem Staubtuch oder leicht feuchtem Lappen reinigen. Keine scheuernden Putzmittel verwenden.
GB	Please only clean with a duster or a damp cloth. Do not use any abrasive cleaners.
F	Le nettoyage se fait uniquement à l'aide d'un torchon ou d'une serviette légèrement mouillée.
HU	A tisztítás kizárólag törölrőruha vagy enyhén nedvesített törölköző segítségével végezhető. Súroló hatású tisztítószerket nem szabad használni.
I	Pulire esclusivamente con un panno o un asciugamano umido.
NL	Reinig alleen met een stofdoek of een lichtjes vochtige doek. Gebruik geen schurende poetsmiddelen.
RU	Очищайте от пыли тряпкой или слегка влажной ветошью. Не допускается применение чистящих средств, не предназначенных для ухода за мебелью.
RO	Curățarea trebuie efectuată numai cu o cârpă sau cu un prosop ușor umezit. Nu utilizați agenți de curățare abrazivi.
SK	Čistení je nutné vykonávať výhradne pomocou utierky alebo ľahko zvlhnutým ručníkom. Nepoužívajte čistiace prostriedky obsahujúce abrazívni častice.
TR	Lütfen sadece bir toz beziyile veya hafif nemli yumuşak bir bezle siliniz. Aşındırıcı temizlik malzemeleri kullanmayınız.

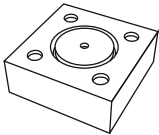
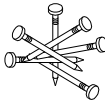

**Karta serwisowa • Servisní list • Service Karte • Service card • Carte de service • Szervizkártya  
Scheda di servizio • Service kaart • Сервисная карта • Fisa service • Servisný list • Servis karti**

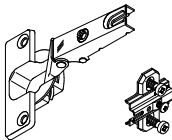
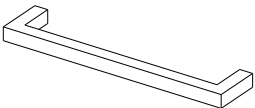

1		2		5	7x50	6	6,3x10,5	15	
									
16 x		16 x		12 x		16 x		1 x	
18	3,5x15	38		48	2x20	49		91	Hinge A
									
48 x		6 x		40 x		4 x		8 x	
126	C42 128 mm	131							
									
2 x		16 x							

