

## Шкаф НЕНСИ 3х створчатый / wardrobe NANCY 3 door

Код ТН ВЭД ЕАЭС

9403 60 100 1  
9403 90 300 0

отрезать  
и приклеить

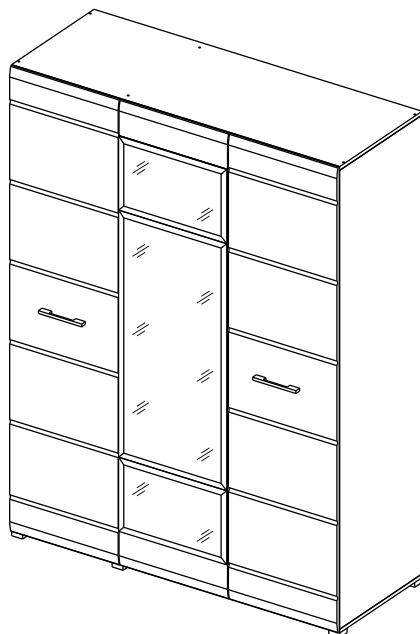

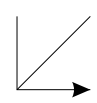
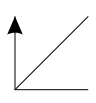
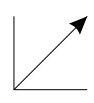
		
1500	2000	466

корпус  
39НВШЗ2558  
39НЯШЗ2580  
39НДШЗ2569

фасад  
39ФБШЗ2591  
39ФКШЗ2620

39ФШЗ2603

Oak gold - Дуб золотой  
Ash light - Ясень светл

### Комплектовочная ведомость / Set package sheet

Упаковка/ Package	Наименование	Description	Décor			Размер/ Size, mm	Кол-во/ Quantity	№
			Wenge	Ash light	Oak gold			
1	Фурнитура	Furniture/Cabinetry hardware	-	-	-	-	1	
2	Боковина левая	Side left	Wenge	Ash light	Oak gold	1950x446	1	1
	Боковина средняя	Side middle				1950x446	1	2
	Боковина правая	Side right				1950x446	1	3
	Крыша	Top				1500x446	2	4
3	Вязка	Connecting element	Wenge	Ash light	Oak gold	968x446	2	5
	Вязка	Connecting element				484x446	2	6
	Полка	Shelves				484x446	2	7
	Тяга	Connecting element				100x968	1	8
	Штанга	Wardrobe tube				-	-	-
4	ХДФ	Back element	Wenge	Ash light	White	341x989	2	11
	ХДФ	Back element				373x505	2	12
	ХДФ	Back element				1292x495	2	13
	ХДФ	Back element				1228x505	1	14
	Соед. Элемент	Connecting back element				-	-	-

Продается отдельно/Sold separately

Упаковка/ Pack	Наименование	Description	Décor		Размер/ Size, mm	Кол-во/ Quantity	№
			White gl	Cacao gl			
1	Створка ЛДСП	Door	White	Ash light	1679x496	1	9
	Створка МДФ	Door	White gl	Cacao gl	1980x496	2	10
	Створка МДФ	Door element	White gl	Cacao gl	150x496	2	17
2	Зеркало	Mirror	-	-	315x495	2	18
	Зеркало	Mirror	-	-	1047x495	1	19

(PL) Instrukcja montażu

(CZ) Návod k montáži

(D) Montageanleitung

(GB) Assembly instruction

(F) Model d'emploi

(HU) Szerelési útmutató

(I) Istruzione di montaggio

(NL) Handleiding voor de montage



(RU) Инструкция по монтажу

(RO) Instrucțiuni de montare

(SK) Návod k montáži

(TR) Montaj talimatı

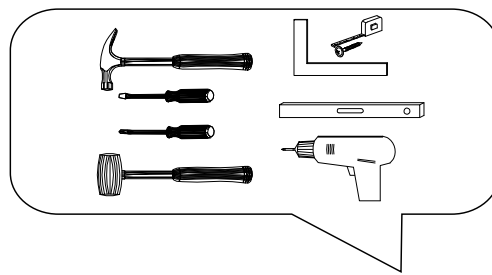



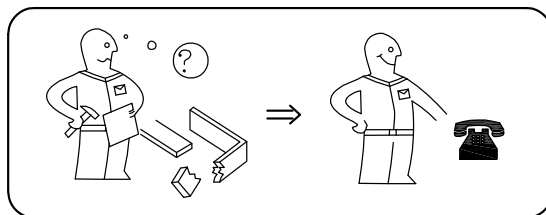
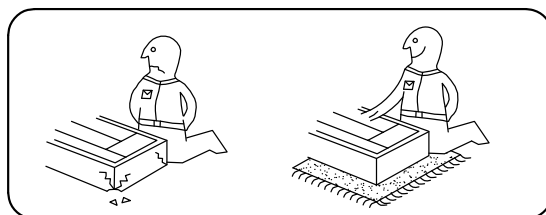



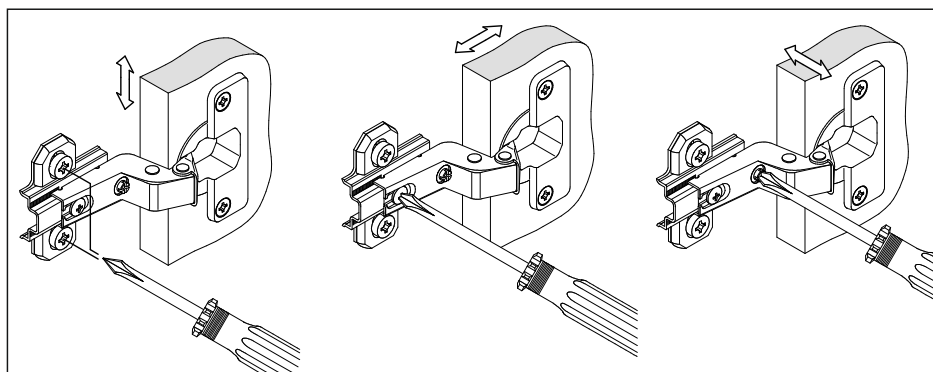
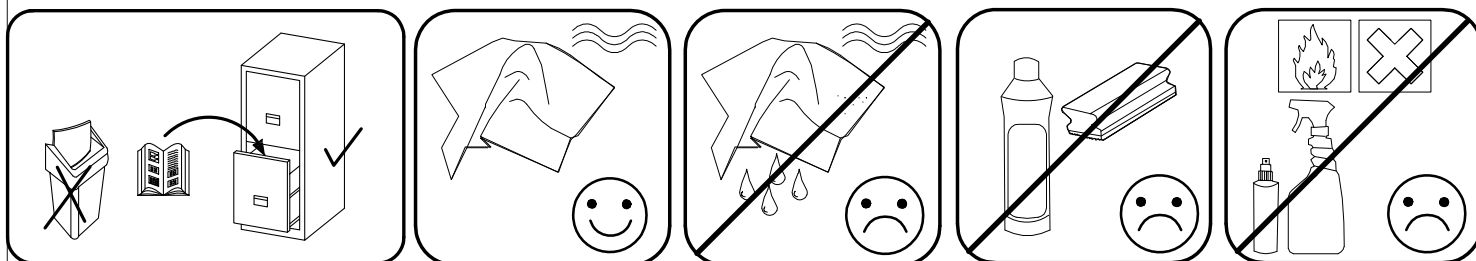

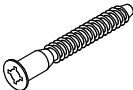

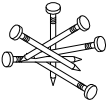

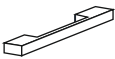
⚠ Uwaga • Upozornění • Achtung • Attention • Caution • Figyelem • Attenzione • Opgelet • Внимание • Atenție • Upozornenie • Dikkat ⚠	
PL	Czyszczenie należy wykonać wyłącznie za pomocą ściereczki lub lekko nawilżonego ręcznika. Nie stosować środków czyszczących do szorowania.
CZ	Čistění je nutné vykonávat výhradně pomocí utěrky nebo lehce navlhčeného ručníku. Nepoužívejte čisticí prostředky obsahující abrazivní částice.
D	Bitte nur mit einem Staubtuch oder leicht feuchtem Lappen reinigen. Keine scheuernden Putzmittel verwenden.
GB	Please only clean with a duster or a damp cloth. Do not use any abrasive cleaners.
F	Le nettoyage se fait uniquement à l'aide d'un torchon ou d'une serviette légèrement mouillée.
HU	A tisztítás kizárólag törölrőruha vagy enyhén nedvesített törölköző segítségével végezhető. Súroló hatású tisztítószerket nem szabad használni.
I	Pulire esclusivamente con un panno o un asciugamano umido.
NL	Reinig alleen met een stofdoek of een lichtjes vochtige doek. Gebruik geen schurende poetsmiddelen.
RU	Очищайте от пыли тряпкой или слегка влажной ветошью. Не допускается применение чистящих средств, не предназначенных для ухода за мебелью.
RO	Curățarea trebuie efectuată numai cu o cârpă sau cu un prosop ușor umezit. Nu utilizați agenți de curățare abrazivi.
SK	Čistení je nutné vykonávať výhradne pomocou utierky alebo ľahko zvlhnutým ručníkom. Nepoužívajte čistiace prostriedky obsahujúce abrazívni častice.
TR	Lütfen sadece bir toz beziyile veya hafif nemli yumuşak bir bezle siliniz. Aşındırıcı temizlik malzemeleri kullanmayınız.

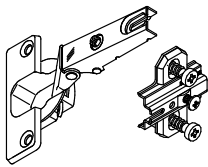
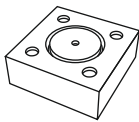
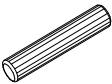

**Karta serwisowa • Servisní list • Service Karte • Service card • Carte de service • Szervizkártya  
Scheda di servizio • Service kaart • Сервисная карта • Fisa service • Servisný list • Servis karti**

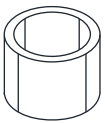

5	7x50	14	3,5x30	18	3,5x15	48	2x20	49	
									
	30 x		6 x		28 x		50 x		2 x
39		117	C 39 (160 mm)	72		6	6,3x10,5	45	
									
	8 x		2 x		24 x		24 x		30 x
91	A	38		8	8x50	15		77	
									
	12 x		6 x		10 x		1 x		1 x
75	for 8	83			2m				
									
	1 x		3 x						
<p>Decor (the handle):</p> <p>Oak gold - C 42 (128 mm)</p> <p>Wenge, Ash light - C 39 (160 mm)</p>									

4

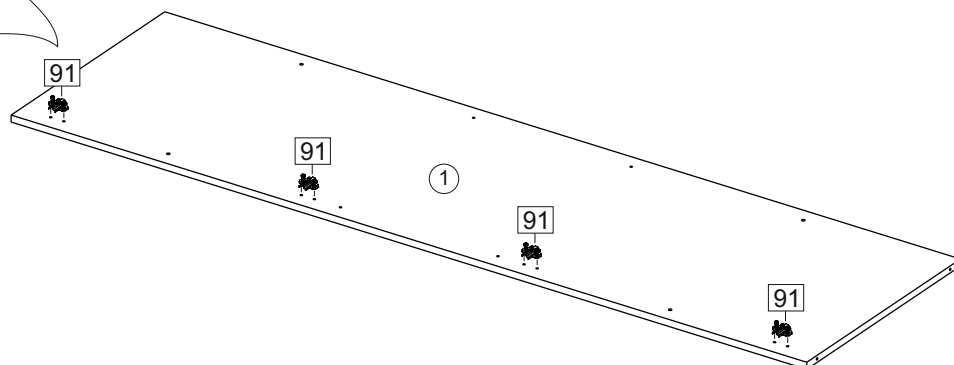
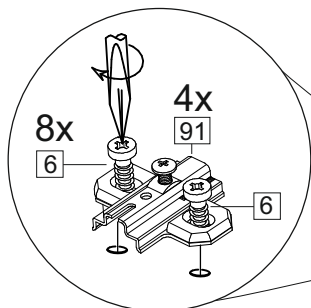
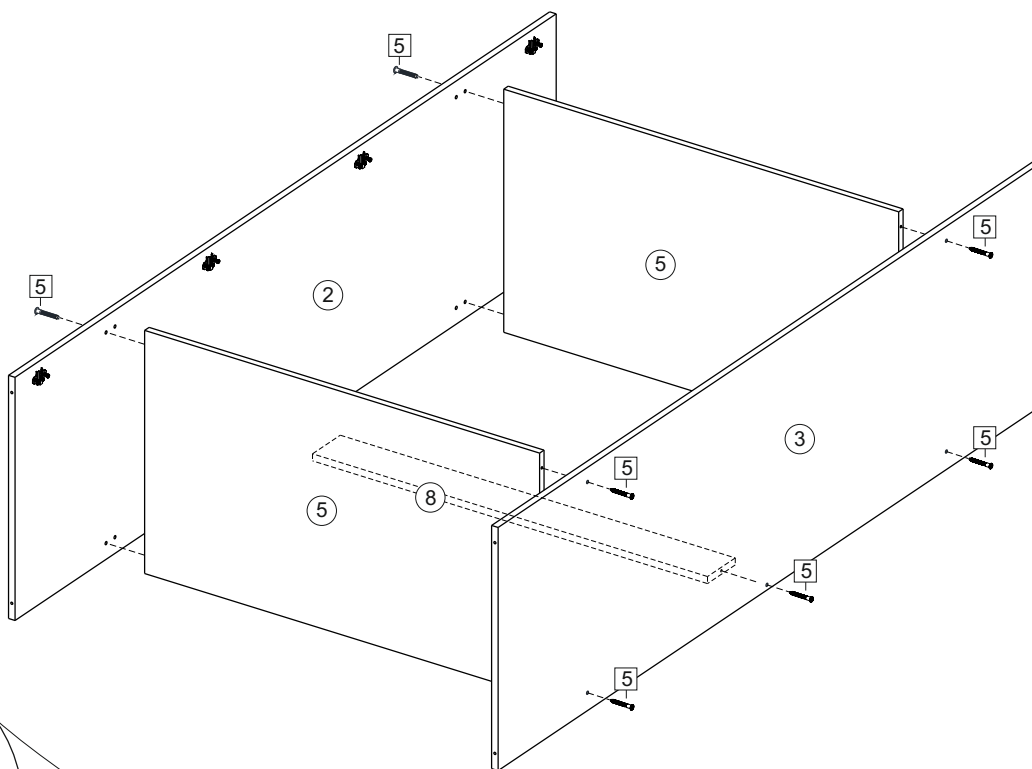
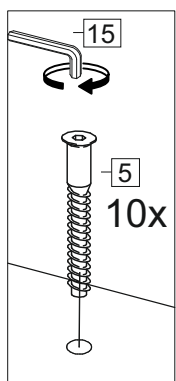
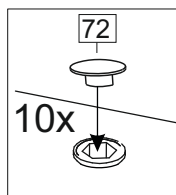
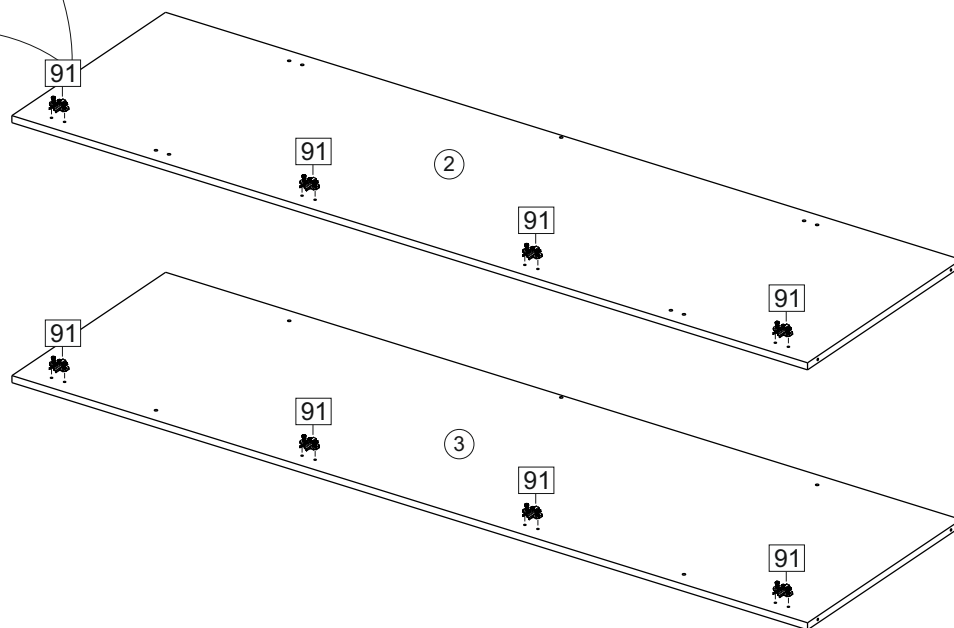
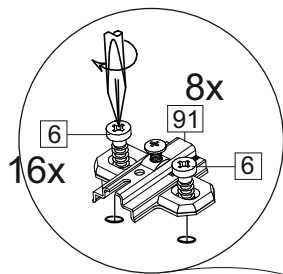

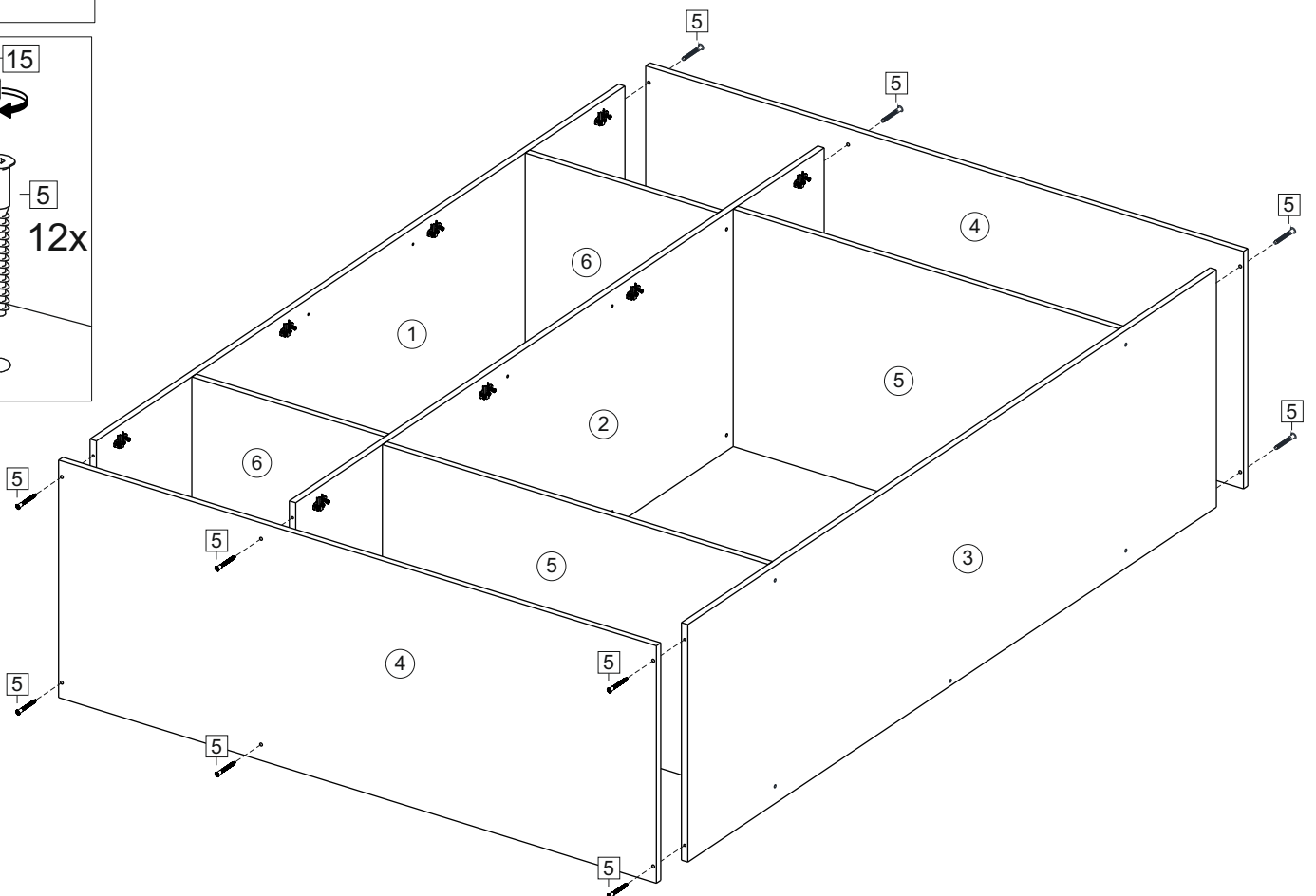
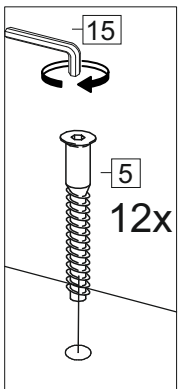
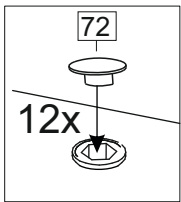
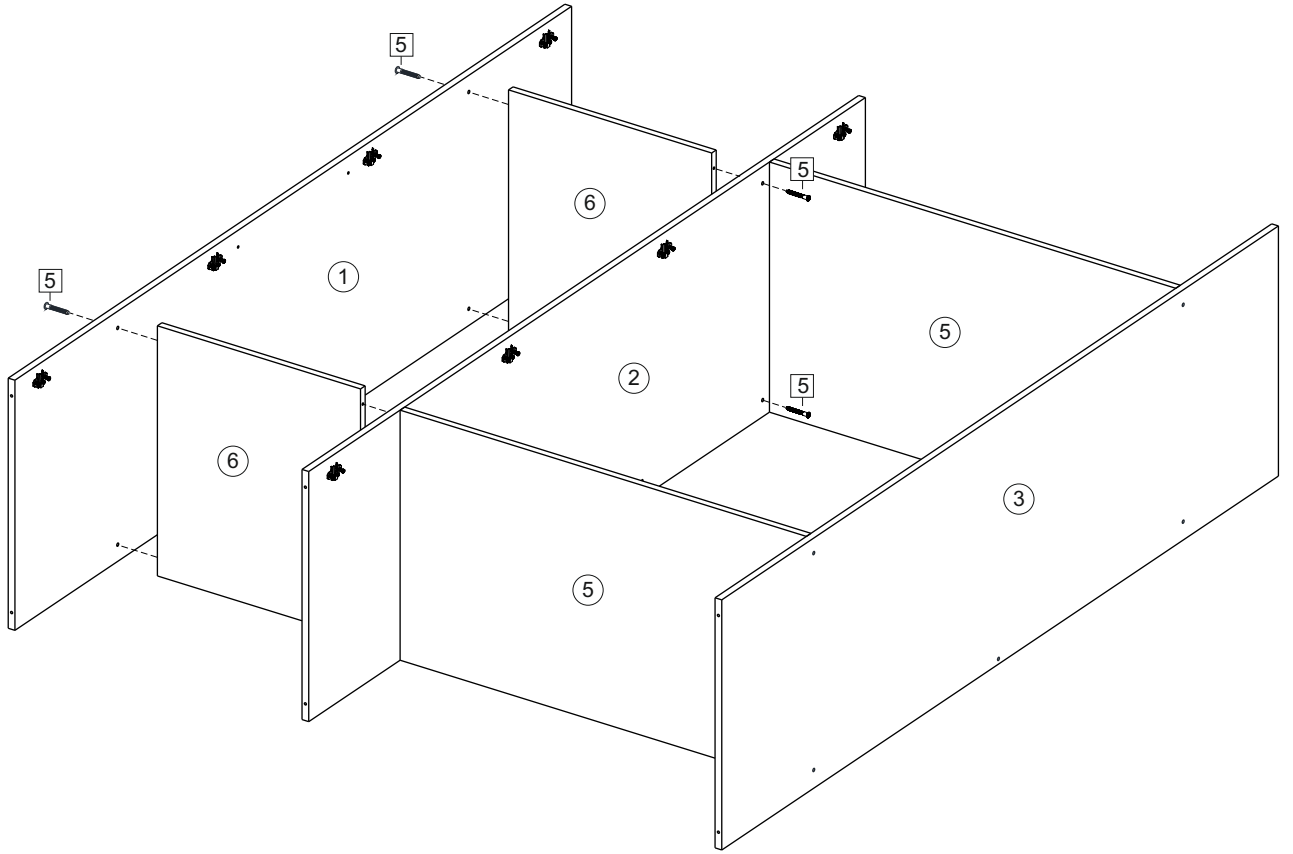
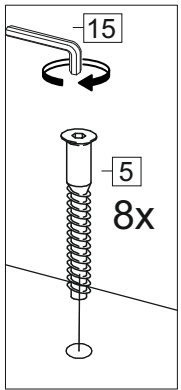
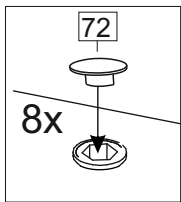

6

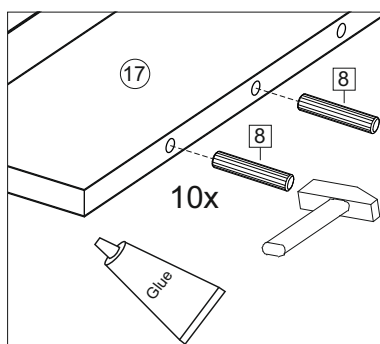
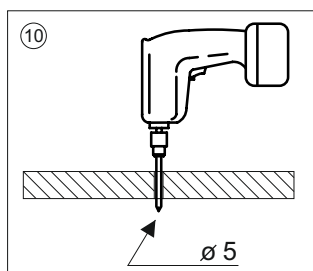
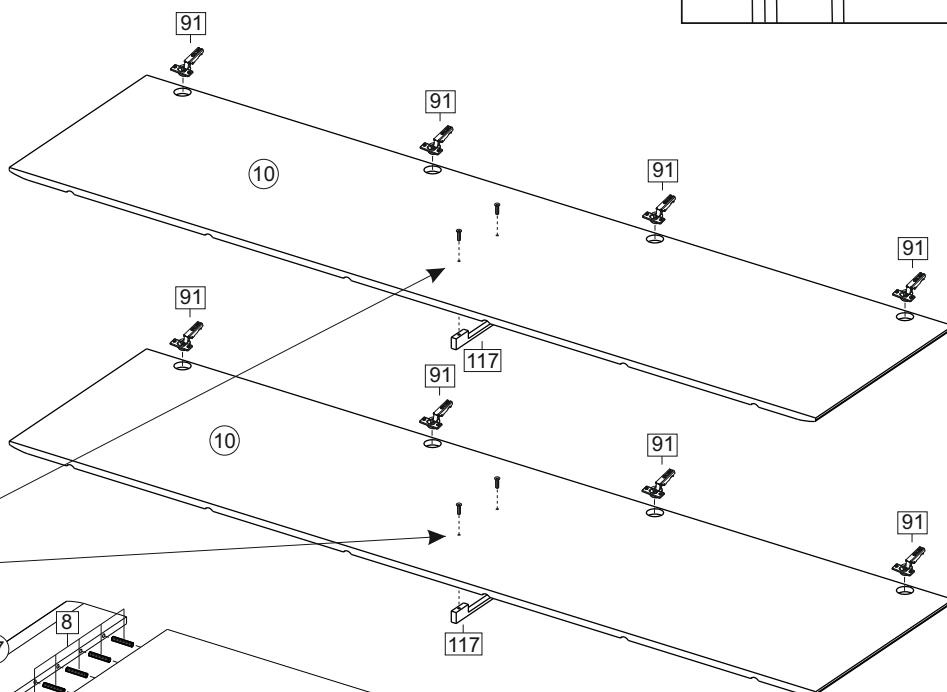
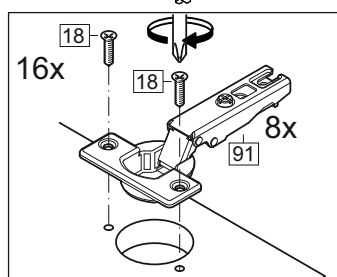
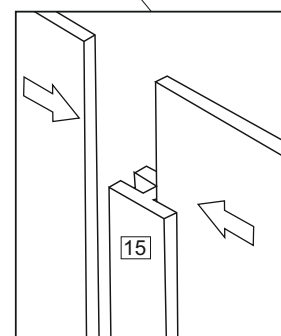
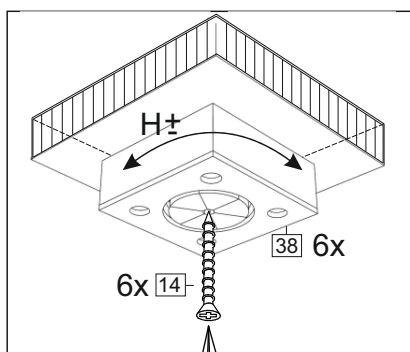
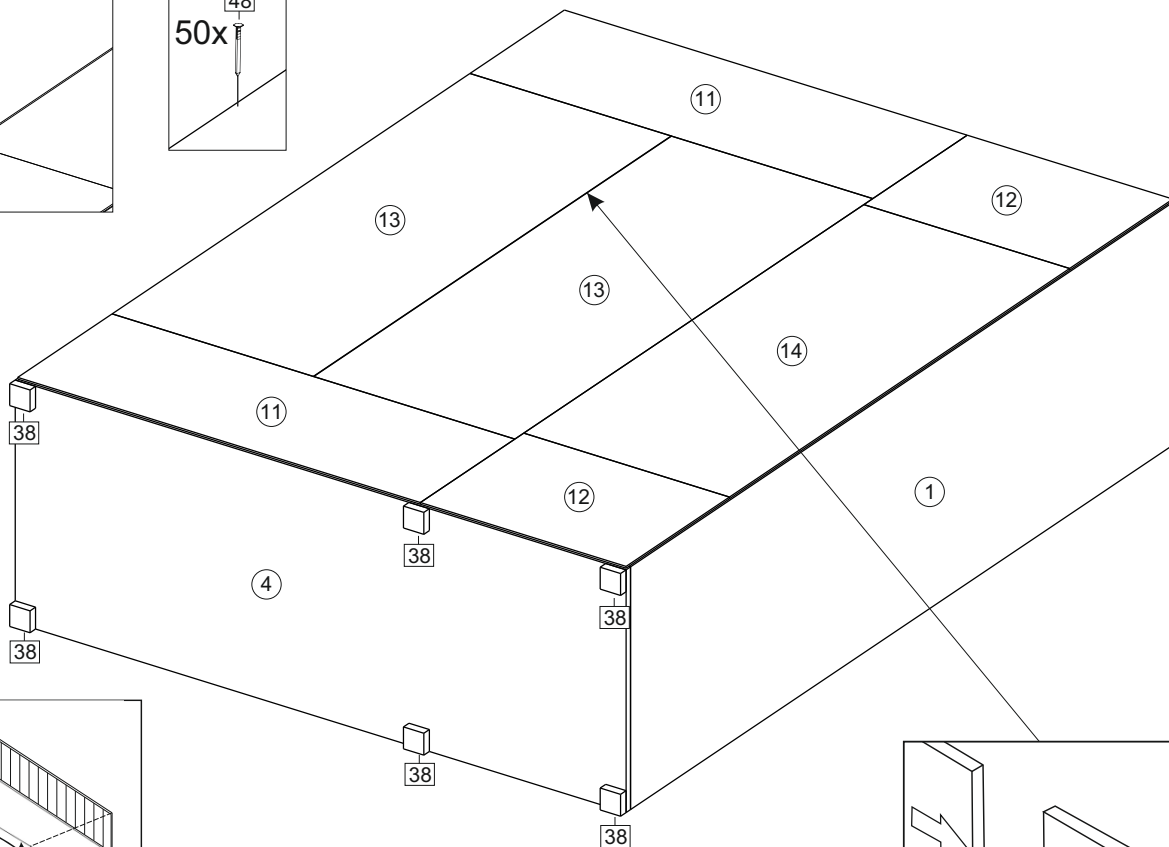
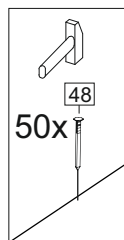
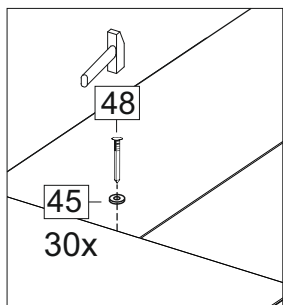

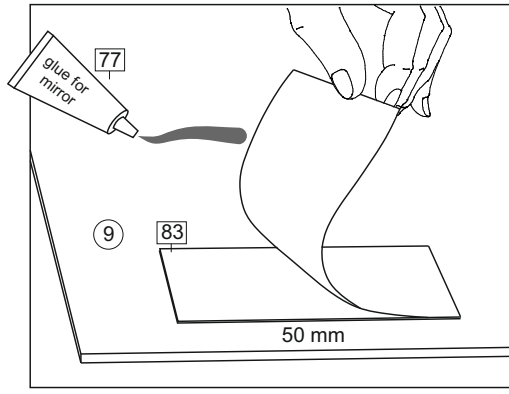
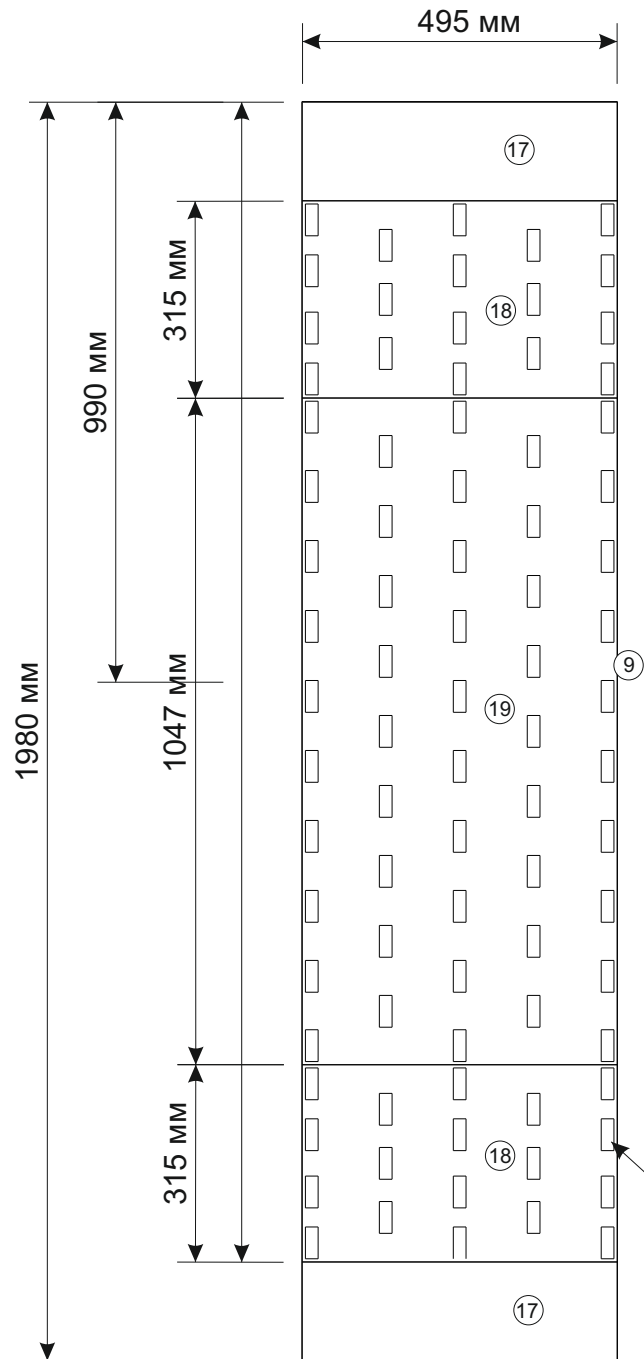
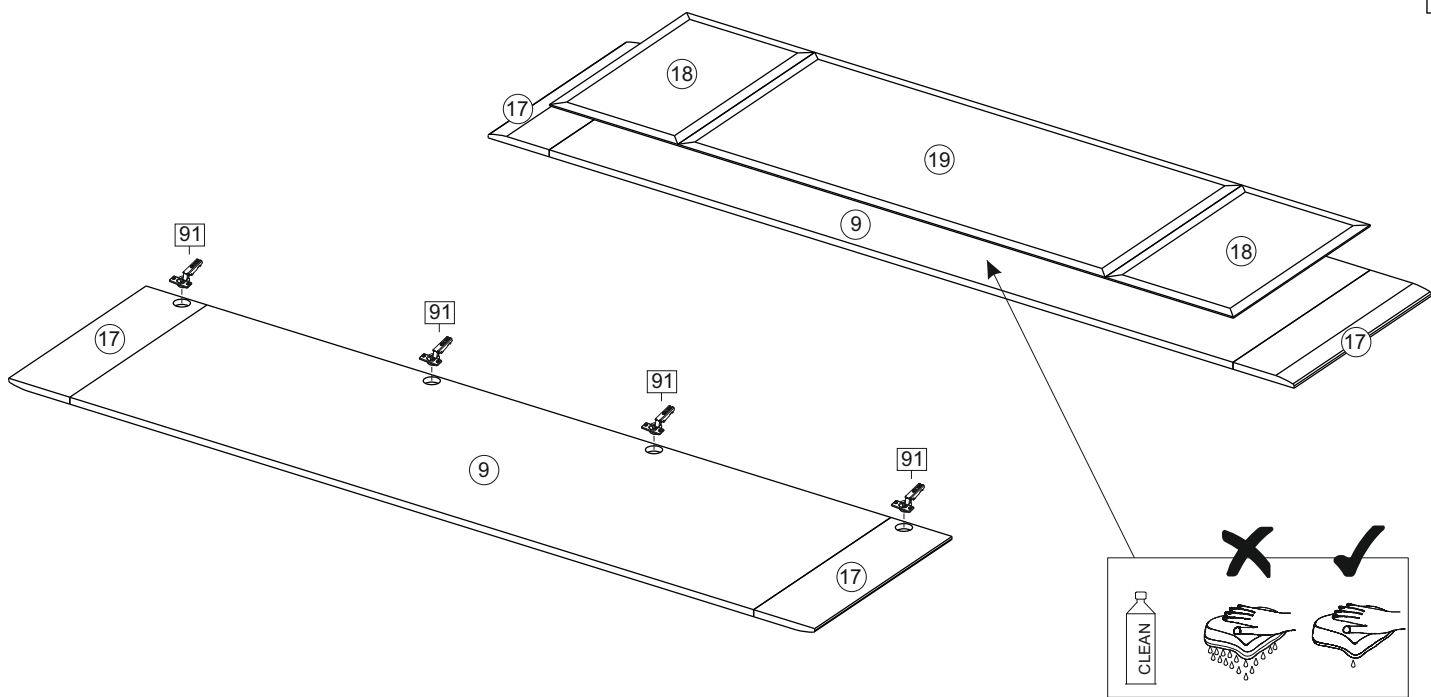

50x20 mm

