

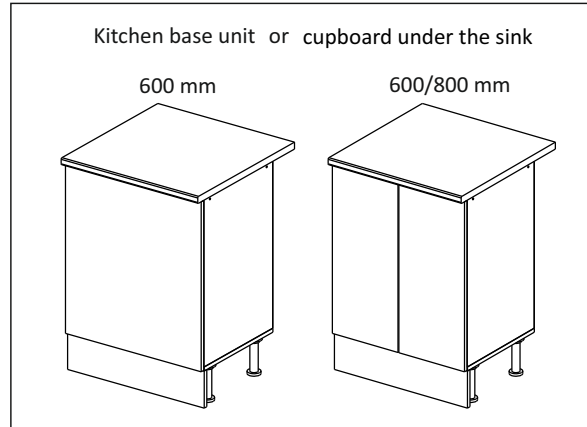

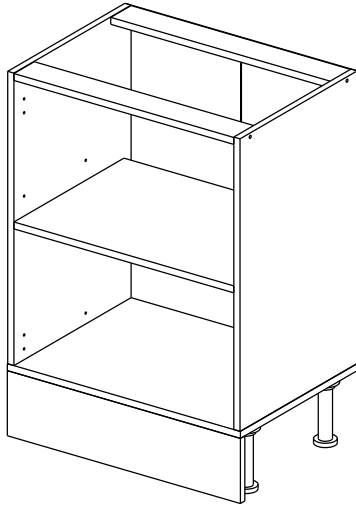

Шкаф-стол напольный 60/80 (также применяется как мойка)
(Kitchen base unit 60/80)

Код ТН ВЭД ЕАЭС

9403 40 100 0
9403 90 300 0

отрезать
и приклеить



		
600/ 800	840	430

корпус - 70СМ80Б / 1620
70СМ60Б / 1619

Комплектовочная ведомость / Set package sheet

Упак/ Package	Наименование	Description	Цвет детали/Décor		Размер / Size, mm		Кол-во/ Quantity	№
					600	800		
Package case	Фурнитура	Furniture/Cabinetry hardware	-	-	-	-	1	-
	Бок левый	Side left	Белый	White	674x426	674x426	1	1
	Бок правый	Side right	Белый	White	674x426	674x426	1	2
	Вязка	Connecting element	Белый	White	566x74	766x74	2	3
	Крышка	Top	Белый	White	600x426	800x426	1	4
	Полка	Shelves	Белый	White	566x400	766x400	1	5
	Цоколь	Socle	Белый	White	152x600	152x800	1	6
Соед. Элемент	Connecting back element	Белый	White	658 мм	658 мм	1	9	

2x







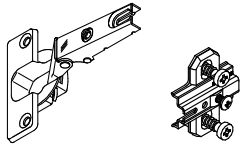
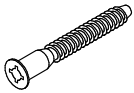

Продается отдельно/Sold separately

Package door/ panel	Створка	Door	см упак/look at the package	Размер / Size, mm		Кол-во/ Quantity	№	
				600	800			
Package door/ panel	Створка	Door	см упак/look at the package	686x296	686x396	1	6	
	ХДФ	Back element	Белый	White	686x296	686x396	1	5
	Ручка	Hadle	-	-	-	-	1	-
Заглушка только для ЛЮКС, КАМЕЛИЯ/Cap only for Lux, Kameliya D35 mm						2	-	

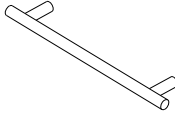
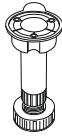
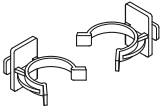
или/or 1x

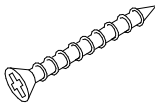
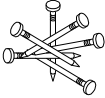
Package door/ panel	Створка	Door	см упак/look at the package	Размер / Size, mm		Кол-во/ Quantity	№
				600	800		
Package door/ panel	Створка	Door	см упак/look at the package	686x596	686x596	1	10
	ХДФ	Back element	Белый	White	686x596	1	7
	Ручка	Hadle	-	-	-	1	-
Заглушка только для ЛЮКС, КАМЕЛИЯ/Cap only for Lux, Kameliya D35 mm						2	-

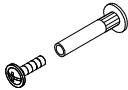
Pack	Столешница	Worktop	см упак/look at the package	Размер / Size, mm		Кол-во/ Quantity	№
				600	800		
Pack	Столешница	Worktop	см упак/look at the package	600x600	800x600	1	8

91	A	5	7*50	39	*		35	H 150 mm	
									
4 x			8 x		4 x	2 x		4 x	
34		6	6,3*10,5	18	3,5*15	14	3,5*30	48	2*20
									
2 x			8 x		28 x		4 x	26 x	
72		71	5 mm	9		15			
									
4 x		12 x		2 x		1 x			

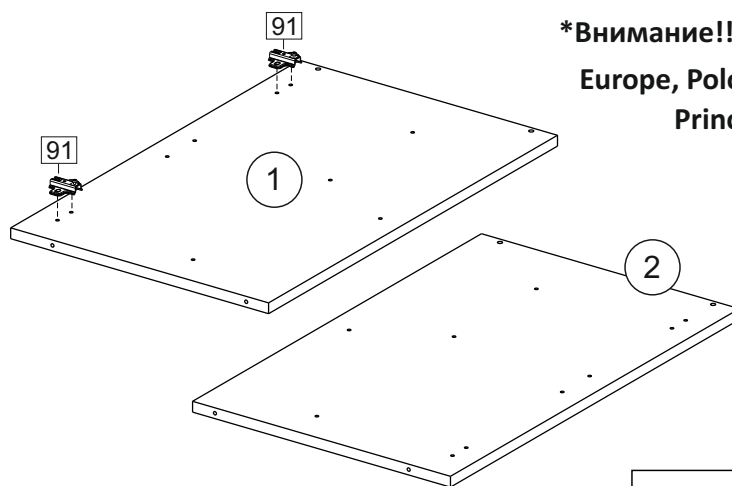
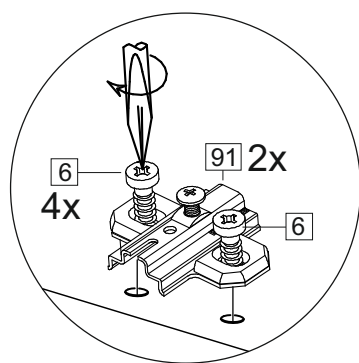

***Внимание!!! Attention!!! Cabinet Handles**

Europe, Polonez, Loft, Lux - C36

Princess, Kameliya - FS 186 096

Vintage - СПА5

Eva - K17

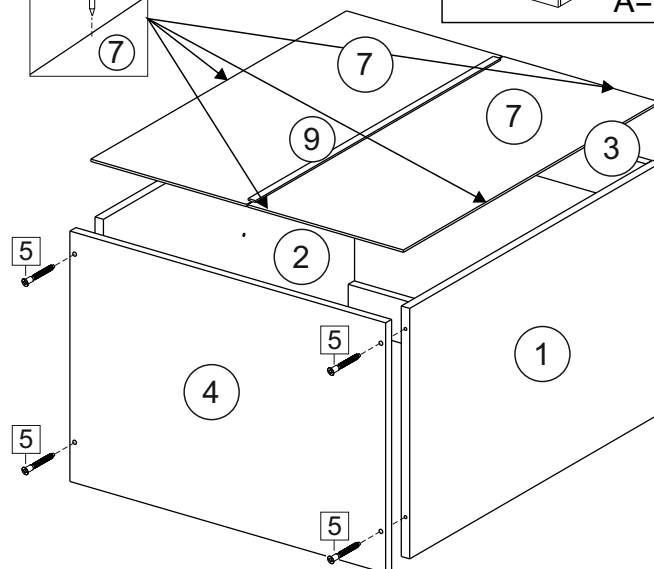
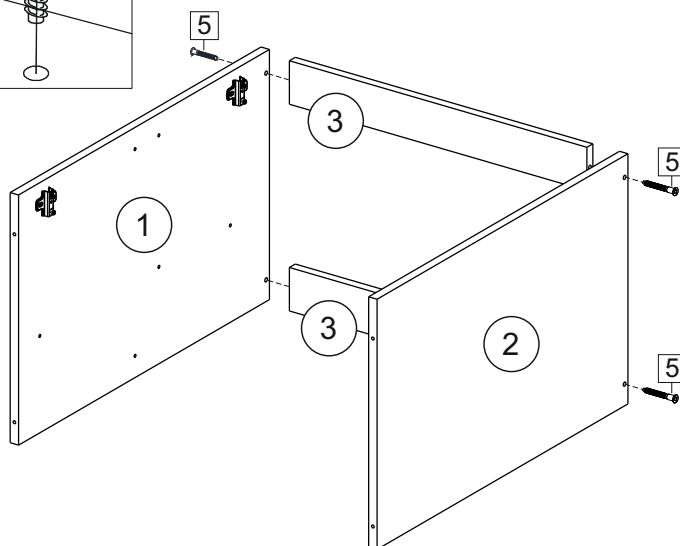
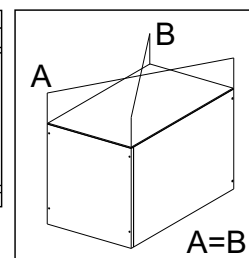
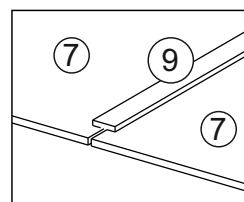
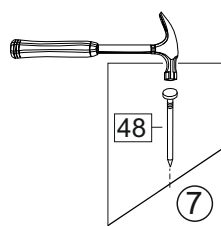
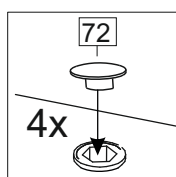
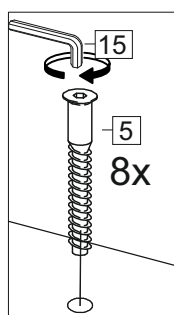

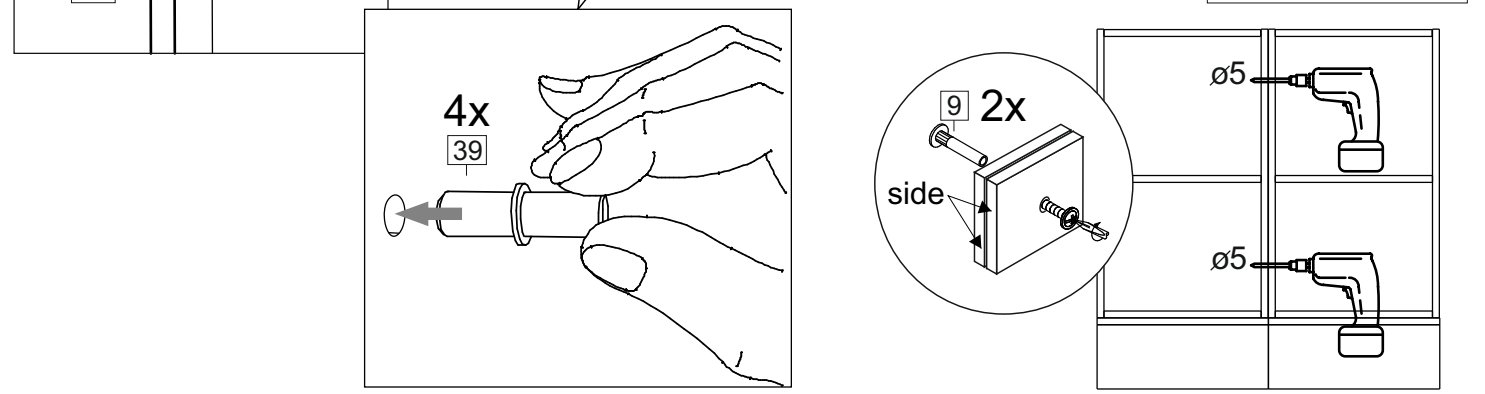

(PL) Instrukcja montażu

(CZ) Návod k montáži

(D) Montageanleitung

(GB) Assembly instruction

(F) Model d'emploi

(HU) Szerelési útmutató

(I) Istruzione di montaggio

(NL) Handleiding voor de montage

(RU) Инструкция по монтажу

(RO) Instrucțiuni de montare

(SK) Návod k montáži

(TR) Montaj talimatı



⚠ Uwaga • Upozornění • Achtung • Attention • Caution • Figyelem • Attenzione • Opgelet • Внимание • Atenție • Upozornenie • Dikkat ⚠	
PL	Czyszczenie należy wykonać wyłącznie za pomocą ściereczki lub lekko nawilżonego ręcznika. Nie stosować środków czyszczących do szorowania.
CZ	Čistění je nutné vykonávat výhradně pomocí utěrky nebo lehce navlhčeného ručníku. Nepoužívejte čisticí prostředky obsahující abrazivní částice.
D	Bitte nur mit einem Staubtuch oder leicht feuchtem Lappen reinigen. Keine scheuernden Putzmittel verwenden.
GB	Please only clean with a duster or a damp cloth. Do not use any abrasive cleaners.
F	Le nettoyage se fait uniquement à l'aide d'un torchon ou d'une serviette légèrement mouillée.
HU	A tisztítás kizárólag törölrőruha vagy enyhén nedvesített törölköző segítségével végezhető. Súroló hatású tisztítószereket nem szabad használni.
I	Pulire esclusivamente con un panno o un asciugamano umido.
NL	Reinig alleen met een stofdoek of een lichtjes vochtige doek. Gebruik geen schurende poetsmiddelen.
RU	Очищайте от пыли тряпкой или слегка влажной ветошью. Не допускается применение чистящих средств, не предназначенных для ухода за мебелью.
RO	Curățarea trebuie efectuată numai cu o cârpă sau cu un prosop ușor umezit. Nu utilizați agenți de curățare abrazivi.
SK	Čistení je nutné vykonávať výhradne pomocou utierky alebo ľahko zvlhnutým ručníkom. Nepoužívajte čistiace prostriedky obsahujúce abrazívni častice.
TR	Lütfen sadece bir toz beziyile veya hafif nemli yumuşak bir bezle siliniz. Aşındırıcı temizlik malzemeleri kullanmayınız.



**Karta serwisowa • Servisní list • Service Karte • Service card • Carte de service • Szervizkártya
Scheda di servizio • Service kaart • Сервисная карта • Fisa service • Servisný list • Servis karti**

