



P300 Series Displays

User's Manual



ZHEJIANG DAHUA VISION TECHNOLOGY CO., LTD.

V1.0.0

Foreword

General





This manual introduces the installation, functions and operations of the P300 Series Display Devices (hereinafter referred to as "the Device"). Read carefully before using the device, and keep the manual safe for future reference.

Models

This manual applies to Dahua P300 series monitoring models. These include: DHI-LM24-P300, DHI-LM24-P300A, DHI-LM27-P300, DHI-LM27-P300A, DHI-LM32-P300, DHI-LM32-P300A.

Safety Instructions

The following signal words might appear in the manual.

Signal Words	Meaning
 DANGER	Indicates a high potential hazard which, if not avoided, will result in death or serious injury.
 WARNING	Indicates a medium or low potential hazard which, if not avoided, could result in slight or moderate injury.
 CAUTION	Indicates a potential risk which, if not avoided, could result in property damage, data loss, reductions in performance, or unpredictable results.
 TIPS	Provides methods to help you solve a problem or save time.
 NOTE	Provides additional information as a supplement to the text.

Revision History

Version	Revision Content	Release Time
V1.0.0	First release.	September 2022

Privacy Protection Notice

As the device user or data controller, you might collect the personal data of others such as their face, fingerprints, and license plate number. You need to be in compliance with your local privacy protection laws and regulations to protect the legitimate rights and interests of other people by implementing measures which include but are not limited: Providing clear and visible identification to inform people of the existence of the surveillance area and provide required contact information.

About the Manual

- The manual is for reference only. Slight differences might be found between the manual and the product.
- We are not liable for losses incurred due to operating the product in ways that are not in compliance with the manual.
- The manual will be updated according to the latest laws and regulations of related jurisdictions. For detailed information, see the paper user's manual, use our CD-ROM, scan the QR code or visit our official website. The manual is for reference only. Slight differences might be found between the electronic version and the paper version.
- All designs and software are subject to change without prior written notice. Product updates might result in some differences appearing between the actual product and the manual. Please contact customer service for the latest program and supplementary documentation.
- There might be errors in the print or deviations in the description of the functions, operations and technical data. If there is any doubt or dispute, we reserve the right of final explanation.
- Upgrade the reader software or try other mainstream reader software if the manual (in PDF format) cannot be opened.
- All trademarks, registered trademarks and company names in the manual are properties of their respective owners.
- Please visit our website, contact the supplier or customer service if any problems occur while using the device.
- If there is any uncertainty or controversy, we reserve the right of final explanation.

Important Safeguards and Warnings

This section introduces content covering the proper handling of the device, hazard prevention, and prevention of property damage. Read carefully before using the device, and comply with the guidelines when using it.

Operation Requirements



WARNING

- Do not tread on or squeeze the power line, especially the plug or connection point of the power line to the product
- Please firmly grasp the plug of the connecting line when inserting and removing. Pulling the connecting line might cause damage to it.
- Turn off the power when cleaning the product.
- Do not touch any fixed components inside the product. Failure to do so can result in damage to the product or person.



- Make sure that the power supply of the device works properly before use.
- Do not pull out the power cable of the device while it is powered on.
- Only use the device within the rated power range.
- Transport, use and store the device under allowed humidity and temperature conditions.
- Prevent liquids from splashing or dripping on the device. Make sure that there are no objects filled with liquid on top of the device to avoid liquids flowing into it.
- Do not disassemble the device.
- Notice and observe all the warnings and illustrations.
- Make sure the power is turned off and the connecting lines are removed when moving the product.
- Do not use uncertified connecting lines, which might cause equipment failure.
- Avoid collisions with the product. This may cause equipment failure.
- Please turn off power for safety if not using the product for a long time.

Installation Requirements



WARNING

- Connect the device to the adapter before power on.
- Strictly abide by local electrical safety standards, and make sure that the voltage in the area is steady and conforms to the power requirements of the device.
- Do not connect the device to more than one power supply. Otherwise, the device might become damaged.
- Do not hang or lean on the product. Doing so can cause the product to fall or become damaged. It may also cause injury to people. Pay special attention when children are nearby.

- If the product is installed on the wall, please make sure the wall's load bearing capacity is sufficient. To avoid falling and injuring people, install according to the included instructions with mounting hardware.
- Do not put the product in flammable or corrosive gaseous environment, which may cause fire or damage the product. Placing the product in proximity to flammable gas can easily result in a dangerous explosion.



- Observe all safety procedures and wear required protective equipment provided for your use while working at heights.
- Do not expose the device to direct sunlight or heat sources.
- Do not install the device in humid, dusty or smoky places.
- Install the device in a well-ventilated place, and do not block the ventilator of the device.
- Use the power adapter or case power supply provided by the device manufacturer.
- The power supply must conform to the requirements of ES1 in IEC 62368-1 standard and be no higher than PS2. Note that the power supply requirements are subject to the device label.
- Connect class I electrical appliances to a power socket with protective earthing.
- Do not block the ventilation opening. Install the product according to this handbook.
- Do not place any items on the product. The product may be damaged if foreign objects enter the internal unit.
- Failure to properly secure all screws during installation can result in a fall of the product. Ensure all mounting hardware and other installation accessories are properly secured during installation.
- Mounted height: < 2m.
-  Protective earthing terminal. The apparatus should be connected to a mains socket outlet with a protective earthing connection.
- ~ Alternating Current.

Maintenance Requirements



WARNING

- Cut off power and the connecting line immediately and contact the after-sales service center if the product or the connecting line is damaged for some reason. Continued use without maintenance might cause smoking or off-odor.
- Please turn off power or unplug the power cable immediately if there is smoking, off-odor, or abnormal noise. Contact the after-sales service center for maintenance after confirming there is no more smoke or odor. Further use could result in fire.



- Do not adjust, maintain or modify if you do not have appropriate qualifications.
- Do not open or remove the rear cover, box or cover board of the product. Please contact the dealer or after-sales service center when in need of adjustment or maintenance.

- Only qualified service people can maintain. If the product gets any kind of damage, such as damage to the plug, foreign matter or liquid into the unit, exposure to rain or humidity, loss of function, or dropped, please contact dealer or after-sales service center.
- Be careful during maintenance of product even if the power is off. Some components are equipped with UPS, and can continue to supply power which is dangerous to people.

Table of Contents

Foreword.....	I
Important Safeguards and Warnings.....	III
1 Packing List.....	1
2 Monitor Adjustment.....	4
3 Button Description.....	6
4 Cable Connection.....	8
5 Menu Description.....	9
6 Brightness and Contrast Adjustment.....	12
7 Operation Menu (OSD) Function Descriptions.....	13
8 Product Specifications.....	15
Appendix 1 Troubleshooting.....	17

1 Packing List



The packing list varies depending on the model you purchase. The packing lists in this section are for reference only. The components that come with the Device might be slightly different from those in the figures.

Figure 1-1 Packing list (DHI-LM24-P300/DHI-LM27-P300)



Table 1-1 Packing list description (1)

No.	Name
1	Display screen
2	Base/Stand
3	Signal cable
4	Power cord
5	Mount stud
6	Screws
7	Harness seat
8	User's manual
9	Legal and regulatory information

Figure 1-2 Packing list (DHI-LM24-P300A/DHI-LM27-P300A)



Table 1-2 Packing list description (2)

No.	Name
1	Display screen
2	Base/Stand
3	Signal cable
4	Power cord
5	Mount stud
6	User's manual
7	Legal and regulatory information

Figure 1-3 Packing list (DHI-LM32-P300)

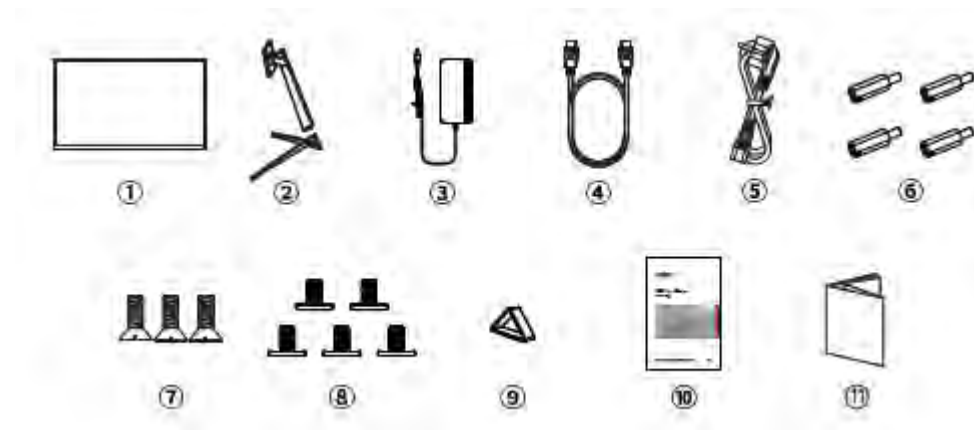

Table 1-3 Packing list description (3)

No.	Name
1	Display screen
2	Base/Stand
3	Power adapter
4	Signal cable
5	Power cord
6	Mount stud
7	KM 4 × 12 screw bolts
8	CM 4 × 23 screw bolts
9	Base decorative cover
10	User's manual
11	Legal and regulatory information

Figure 1-4 Packing list (DHI-LM32-P300A)

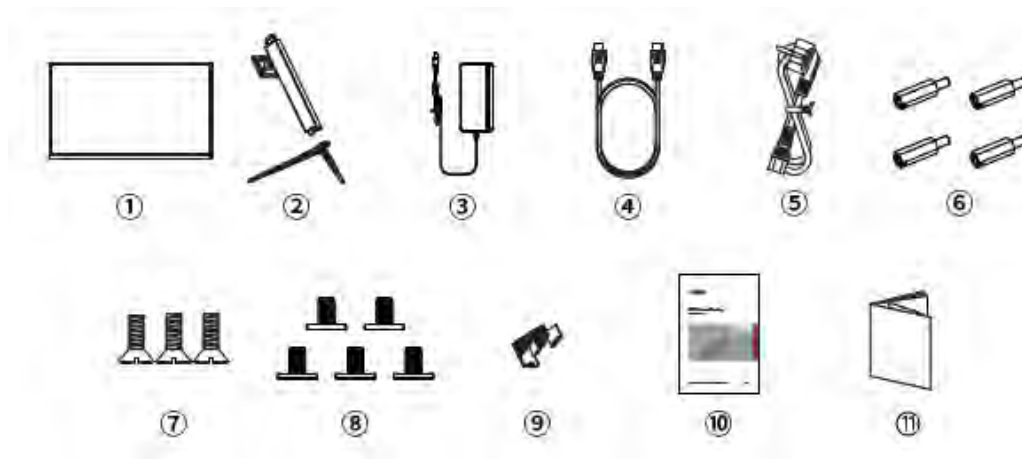

Table 1-4 Packing list description (4)

No.	Name
1	Display screen
2	Base/Stand
3	Power adapter
4	Signal cable
5	Power cord
6	Mount stud
7	KM 4 × 12 screw bolts
8	CM 4 × 23 screw bolts
9	Base decorative cover
10	User's manual
11	Legal and regulatory information

2 Monitor Adjustment

The adjustment functions of the display screen include tilt angle adjustment, screen vertical rotation angle adjustment, left and right rotation angle adjustment and height adjustment, as shown in the following figures.

Different types of displays have different adjustment functions. Some displays have one or more of the adjustment functions, and some displays are not adjustable. The specific adjustment function is subject to the function of the actual model display. The four adjustment functions shown in the following figures are only used to illustrate the adjustment function.

Figure 2-1 Portrait rotation angle adjustment

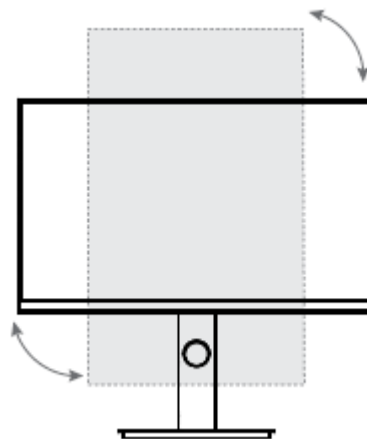

Figure 2-2 Adjust the angle of rotation left and right

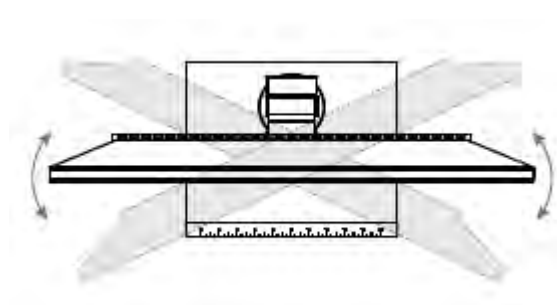

Figure 2-3 Tilt angle adjustment

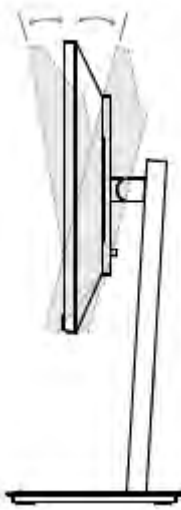
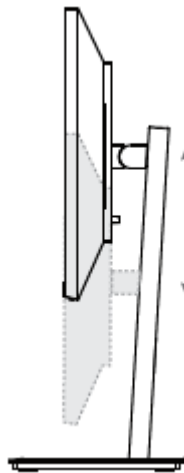

Figure 2-4 Height adjustment



- When adjusting the angle of the monitor, be sure not to touch or press the area of the screen.
- The above figures are for reference only, and everything is subject to the actual adjustment function.

3 Button Description

Figure 3-1 Indicator and buttons (DHI-LM24-P300/DHI-LM24-P300A/DHI-LM27-P300/DHI-LM27-P300A)

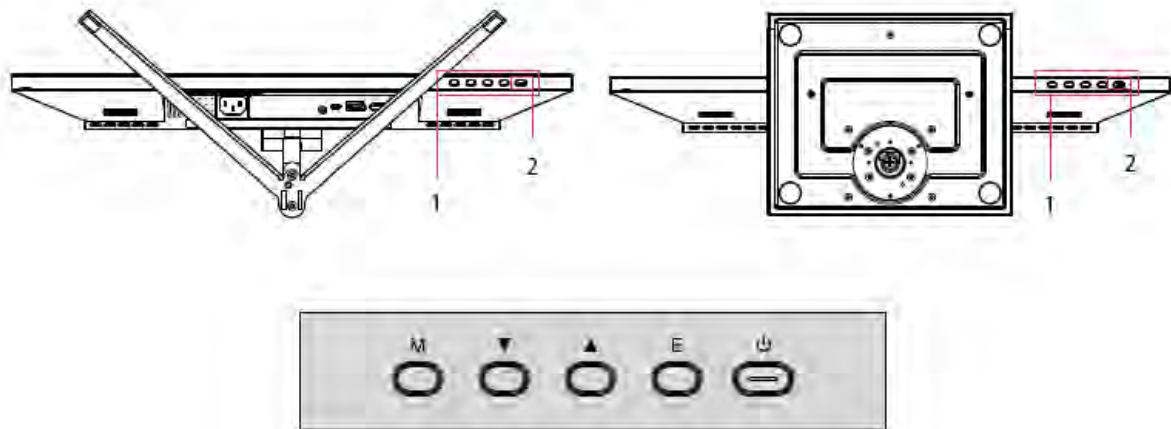

Table 3-1 Button description

No.	Name	Description
1	LED indicator light/Power button	<ul style="list-style-type: none"> A solid white light indicates that the power supply is normal. The light is red when the screen enters energy saving mode. The light is off when the screen is turned off. Press the button to turn on the monitor.
2	OSD buttons	Operate the OSD menu.

Table 3-2 OSD buttons

OSD Button	Function
M	Menu button: Press to display OSD menu and enter sub-menus.
▼	Down button: Move down in the menu/Adjust the brightness.
▲	Up button: Move up/Adjust the contrast.
E	Exit key: Returns to the previous menu/Switch port input signal.
⏻	Power button: Press to turn monitor on/off.



The above content is for reference only, and everything is subject to actual conditions.

Figure 3-2 Indicator and buttons (DHI-LM32-P300/DHI-LM32-P300A)

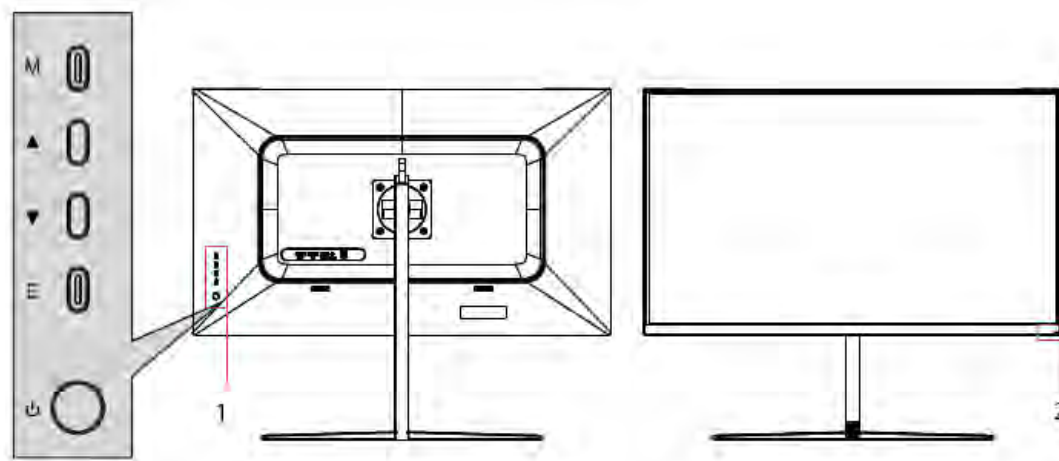

Table 3-3 Button description

No.	Name	Description
1	OSD buttons	Operate the OSD menu.
2	LED indicator light	<ul style="list-style-type: none"> The blue light indicates that the power supply is normal and the monitor is running normally. Flashing blue light indicates no video source, no horizontal or vertical signals, or too low a voltage. The light is off when the screen is turned off.

Table 3-4 OSD buttons

OSD Button	Function
M	Menu button: Press to display OSD menu and enter sub-menus.
▼	Down button: Move down in the menu/Adjust the brightness.
▲	Up button: Move up/Adjust the contrast.
E	Exit key: Returns to the previous menu/Switch port input signal.
⏻	Power button: Press to turn monitor on/off.



The above content is for reference only, and everything is subject to actual conditions.

4 Cable Connection

Figure 4-1 Input and output ports



Table 4-1 Port description

Port	Function
DC	Used to connect power adaptors.
DP	Use the DP cable to connect to a desktop PC.
HDMI	Use the HDMI cable to connect the HDMI IN interface of the product to the HDMI OUT interface of a PC.
AUDIO OUT	Use to connect with external sound output devices such as headphones or earphones.
TYPE-C	Type-C line can be used to connect to data ports of machines. and external terminals.
AC IN	Insert the power cable to supply power to the monitor.



The above ports are for reference only, the actual ports of different types of monitors may be slightly different from the ports in the figure, and everything is subject to the ports and functions of the actual product.

5 Menu Description

- The color and shape of the OSD menu of the actual computer may be slightly different from them shown in the figure, and everything that has been actually displayed shall prevail.
- Specifications of the OSD menu may change with improvements of functions without prior notice.

When booting for the first time, you need to set the default language of the monitor menu. Press buttons (▼ or ▲) to select the language to be set, and press the OK button (M) to confirm.

Figure 5-1 Language setting window



The on-screen display (OSD) menu can be used to adjust the settings of the monitor and is displayed on the screen after turning on the monitor and pressing the  button.

Step 1 Press any one of the buttons (M, ▼, ▲, E, ) to activate the navigation window.

Figure 5-2 Navigation window

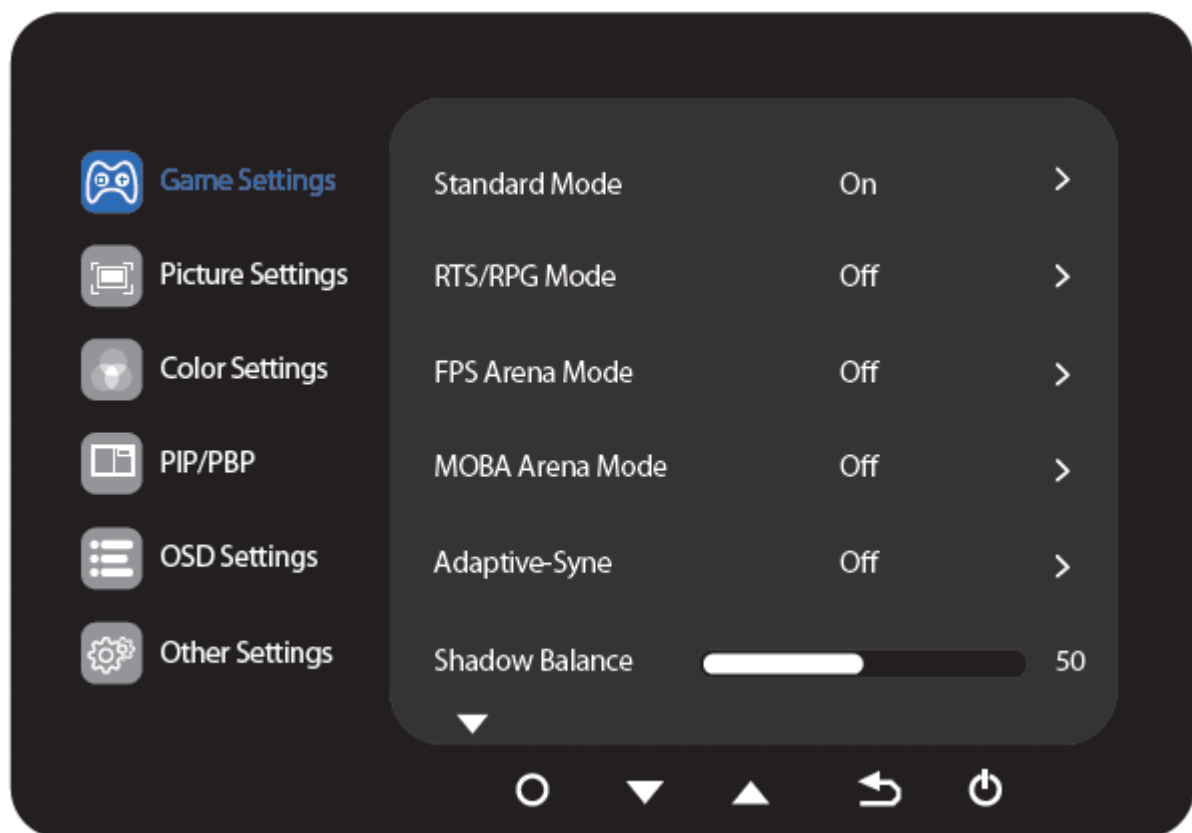

Table 5-1 Icon function

Icon	Function
	Confirm and enter the main menu.
	Adjust the brightness
	Adjust the contrast.
	Switch port input signal.
	Power switch.

Step 2 Press **M** to enter the OSD screen.

Figure 5-3 OSD screen



Step 3 Press **▼** or **▲** to browse through the functions.

- Select the desired function, then press **M** to enter the submenu.
- Press **▼** or **▲** to browse the sub-menus, and then press **M** to confirm the selection of the desired function.

- Press ▼ or ▲ to select an option, then press **M** to confirm the setting and exit the current menu.

Step 4 Press **E** to exit the menu interface.

6 Brightness and Contrast Adjustment

Step 1 Press any one of the buttons (M, ▼, ▲, E, ⏻) to activate the navigation window.

Figure 6-1 Navigation window



Step 2 Press ▼ or select ⚙️ to quickly open the **Adjust Brightness** window and then press the ▼ or ▲ button to adjust the brightness that suits you best.

Figure 6-2 Brightness adjustment window

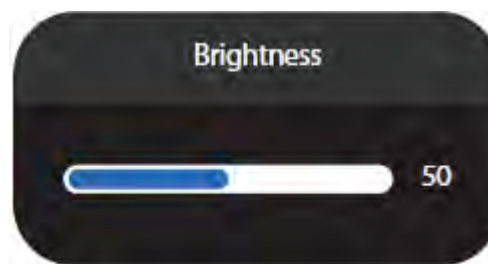

Step 3 Press ▲ or select ◻️ to quickly open the contrast adjustment window, and then press the ▼ or ▲ button to adjust the contrast that suits you best.

Figure 6-3 Contrast adjustment window

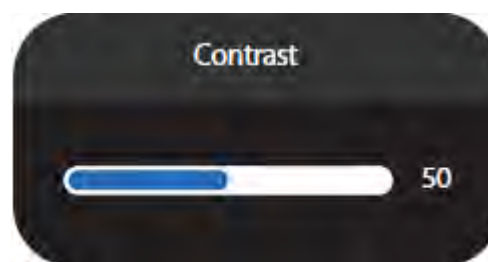

7 Operation Menu (OSD) Function Descriptions

Functions of the monitor vary with models, and the functions in this manual are for reference only.

Table 7-1 Menu description

Menu	Sub Menu	Value Range
Game Settings	Standard Mode	Off/On
	RTS/RPG Mode	Off/On
	FPS Arena Mode	Off/On
	MOBA Arena Mode	Off/On
	Adaptive-Sync	Off/On
	Shadow Balance	0-100
	Response Time	Off/Normal/Fast/Ultrafast
	Refresh Rate	Off/On/Position: Top Right, Top Left, Bottom Right, Bottom Left
	Game Crosshair	Off/Crosshair 1/Crosshair 2/Crosshair 3/Crosshair 4/Crosshair 5/Crosshair 6
	Game Time	Off/15 minutes/30 minutes/45 minutes/60 minutes/Position: Top Right, Top Left, Bottom Right, Bottom Left
	Dynamic Brightness	Off/Normal/Expert/Elaboration
Physical Super View	Off/On/Position: Top Right, Top Left, Bottom Right, Bottom Left, Center	
Picture Settings	Brightness	0-100
	Contrast	0-100
	DCR	Off/On
	Contextual model	Off/Movie Mode/Reading Mode/Night Mode/Care Eyes Mode
	Low Blue Light	0-100
	Sharpness	0-5
	Gamma	1.8/2.0/2.2/2.4/2.6/S.curve
	Aspect Ratio	Wide Screen/4:3/1:1/Auto
Color Settings	Warm	Off/On
	Natural	Off/On
	Cool	Off/On
	User1	Off/On: R, G, B
	User2	Off/On: R, G, B
	User3	Off/On: R, G, B
	Hue	R/G/B/C/M/Y
	Saturation	R/G/B/C/M/Y
PIP/PBP	PIP/PBP Mode	Off/PIP Mode/PBP 2Win 1:1/PBP 2Win 2:1/PBP 2Win 1:2
	Sub-Signal Source	Type-C/DP/HDMI
	Audio Source	Auto/Type-C/DP/HDMI

	PIP Position	Top Right/Top Left/Bottom Right/Bottom Left
	PIP Size	Small/Medium/Large
	Window Swap	—
OSD Settings	Language	简体中文/ENGLISH /한국어/العربى/Portugues do Brasilazil/Deutsch/Nederland/Suomi/Français/Ελληνικά/Indonesia/Italiano/日本語/Malaysia/Polskie/Português/Русский/Español/ไทย/Українська/Tiếng Việt/繁體中文/Türkçe
	OSD Time Out	0-60
	OSD H-Position	0-100
	OSD V-Position	0-100
	OSD Transparency	0-5
	OSD Rotation	Normal/90/180/270
	OSD Lock	Off/On
	Hotkey1 setting	Brightness
	Hotkey2 setting	Contrast
	Hotkey3 setting	Input Signal/Mute/Shadow Balance/Game Crosshair/Refresh Rate/Game Time/Contextual Model/PIP/PBP/Input Signal/Dynamic Brightness/Physical Super View
Other Settings	Input Signal	Auto/Type-C/DP/HDMI
	Volume	0-100
	Mute	Off/On
	Auto power	Off/On
	Eyeshield remind	Off/On
	Reset	Off/On
	Information	Input Source/Resolution/Mode/HDR Ver/SN



The OSD features in the table above are for reference only and may differ from the actual display, so the OSD features of the actual display shall prevail.

8 Product Specifications

Table 8-1 Product specifications (1)

Product model		DHI-LM24-P300	DHI-LM27-P300	DHI-LM32-P300
Screen Size		24"	27"	31.5"
Aspect Ratio		16:9	16:9	16:9
Viewing Angle		178°(H)/178°(V)	178°(H)/178°(V)	178°(H)/178°(V)
Contrast ratio		1000:1 (TYP)	1000:1 (TYP)	1200:1 (TYP)
Colors		16.7M	16.7M	16.7M
Resolution		2560 × 1440	2560 × 1440	2560 × 1440
Maximum refresh rate		75 Hz	75 Hz	75 Hz
Product Dimensions	Without base	539.6 × 324.5 × 61.0 mm	613.3 × 367.3 × 64.9 mm	718.6 × 422.1 × 47.4 mm
	Lifting base With base	539.6 × 419.8 × 199.3 mm	613.3 × 499.6 × 199.3 mm	718.6 × 519.2 × 236.1 mm
Speaker		No	No	No
Height range		No	No	No
Rotation angle		No	No	No
Vertical angle		No	No	No
Tilting angle		Forward tilting : 5° ± 2°; Backward tilting: 20° ± 2°		
Environmental conditions	Action	Temperature: 0 °C to 40°C (32°F to 104°F) Humidity: 10%–90% RH (non-condensing)		
	Storage	Temperature: -20 °C to +60°C (-4 °F to +140 °F) Humidity: 5%–95% RH (non-condensing)		



The above parameters are for reference only, and the parameters of the actual model shall prevail.

Table 8-2 Product specifications (2)

Product model		DHI-LM24-P300A	DHI-LM27-P300A	DHI-LM32-P300A
Screen Size		24"	27"	31.5"
Aspect Ratio		16:9	16:9	16:9
Viewing Angle		178°(H)/178°(V)	178°(H)/178°(V)	178°(H)/178°(V)
Contrast ratio		1000:1 (TYP)	1000:1 (TYP)	1200:1 (TYP)
Colors		16.7M	16.7M	16.7M
Resolution		2560 × 1440	2560 × 1440	2560 × 1440
Maximum refresh rate		75 Hz	75 Hz	75 Hz
Product Dimensions	Without base	539.6 × 324.5 × 61.0 mm	613.3 × 367.3 × 64.9 mm	718.6 × 422.1 × 47.4 mm
	Lifting base With base	539.6 × 513.6 × 149.3 mm	613.3 × 543.4 × 194.3 mm	718.6 × 602.0 × 256.1 mm
Speaker		No	No	No

Height range		125 mm (± 5 mm)	125 mm (± 5 mm)	125 mm (± 5 mm)
Rotation angle		-45 °C (± 2.0 °C) to +45 °C (± 2.0 °C)	-45 °C (± 2.0 °C) to +45 °C (± 2.0 °C)	-45 °C (± 2.0 °C) to +45 °C (± 2.0 °C)
Vertical angle		-90 °C (± 2.0 °C) to +90 °C (± 2.0 °C)	-90 °C (± 2.0 °C) to +90 °C (± 2.0 °C)	-90 °C (± 2.0 °C) to +90 °C (± 2.0 °C)
Tilting angle		Forward tilting : $5^\circ \pm 2^\circ$; Backward tilting: $20^\circ \pm 2^\circ$		
Environmental conditions	Action	Temperature: 0 °C to 40°C (32°F to 104°F) Humidity: 10%–90% RH (non-condensing)		
	Storage	Temperature: -20 °C to +60°C (-4 °F to +140 °F) Humidity: 5%–95% RH (non-condensing)		



The above parameters are for reference only, and the parameters of the actual model shall prevail.

Appendix 1 Troubleshooting

Appendix Table 1-1 FAQ

Faults Occurring	Possible Solutions
The power indicator light is not on	<ul style="list-style-type: none"> ● Check if the power is on. ● Check if the power cord is connected.
Plug and play failed	<ul style="list-style-type: none"> ● Check if the function of plug-and-play of the device is compatible with PC. ● Check if the display card is compatible with the plug-and-play function.
Dimming picture	Adjust brightness and contrast.
Flickering picture or picture with ripples	There may be electrical appliances or equipment with electronic disturbance.
The power indicator light is on (flickering), but the monitor has no pictures.	<ul style="list-style-type: none"> ● Check if the PC power is on. ● Check if the PC display card is inserted properly. ● Check if the signal cable of the monitor is correctly connected with the PC. ● Check the signal cable plug of the monitor and make sure every pin has no bending. ● Observe the indicator light by pressing the Caps Lock key on the PC keyboard and check if the PC is working.
Color shortage (red, green and blue)	Check the signal cable of the monitor and make sure every pin has no bending.
The picture is not in the middle, or the size is not right	Hot key(AUTO)
Picture with color difference (white looks not white)	Adjust RGB color or reselect color temperature.
Screen font blur under VGA signal	Select E to automatically adjust the image.
Screen color error under VGA signal	Select Auto color in OSD to correct under the white output screen.



The above solutions are for reference only. If you have any problems, please contact the after-sales service center or find a professional to help.

ENABLING A SAFER SOCIETY AND SMARTER LIVING

ZHEJIANG DAHUA VISION TECHNOLOGY CO., LTD.

Address: No. 1399, Binxing Road, Binjiang District, Hangzhou, P. R. China | Website: www.dahuasecurity.com | Postcode: 310053

Email: dhoverseas@dhvisiontech.com | Tel: +86-571-87688888 28933188