

INSTALLATION GUIDE

SE-214-XT / SE-903-XT Series

20220221-V2

Components List

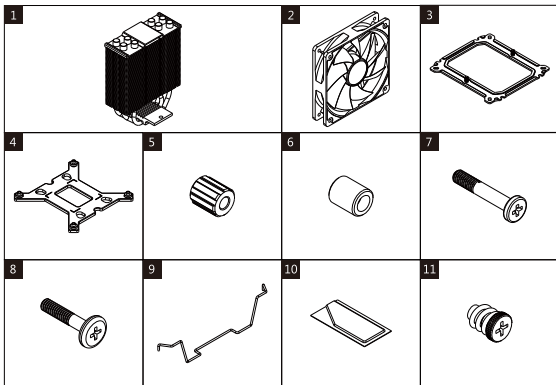

1) Heatsink ×1

2) Fan ×1

3) Universal Bracket ×1

4) Intel Backplate ×1

5) Standoff for LGA1700 ×4

6) Standoff for LGA1200 and AMD ×4

7) Intel Screw ×4

8) AMD Screw ×4

9) Fan Clip ×2

10) Thermal Grease ×1

11) Tightening Nut ×2

Bracket Illustration

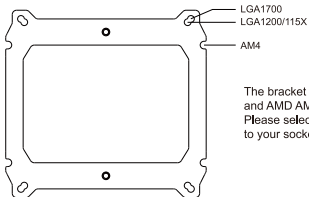

The bracket is universal for Intel LGA1700/1200/115X and AMD AM4.
Please select the correct mounting position according to your socket type.

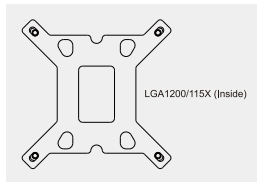
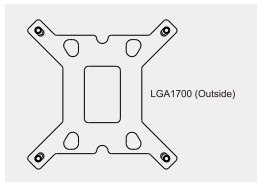

Intel Backplate Illustration

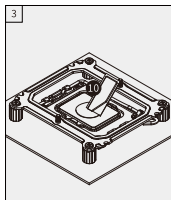
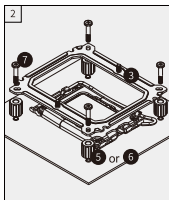
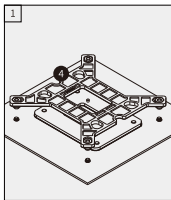

The Intel backplate is designed for LGA1700 and LGA1200/115X sockets. Push the screws to the outside for LGA1700. Push the screws to the inside for LGA1200/115X.

Intel LGA1700/1200/115X



Note: Please choose the correct mounting position on the bracket and also choose the correct standoffs before the installation.  for LGA1700 /  for LGA1200/115X. Put the backplate through the back of the motherboard; put on the correct standoffs and then secure the bracket with the Intel screw.

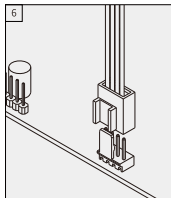
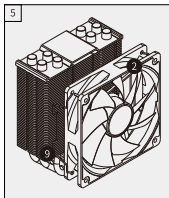
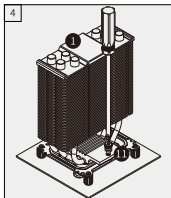

Apply a thin layer of thermal grease to the CPU and then secure the heatsink with the tightening nuts. Finish the installation by connecting the fan cable to "CPU_FAN" header.

AMD AM5/AM4

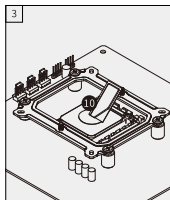
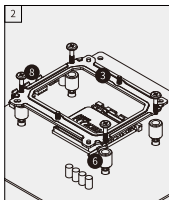
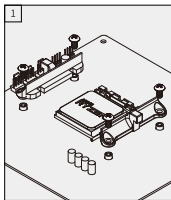

Remove the original AMD plastic retention frame, but keep the backplate; put the standoff on and then secure the bracket with AMD screws.

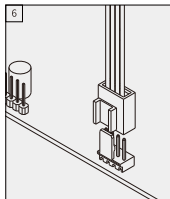
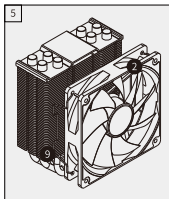
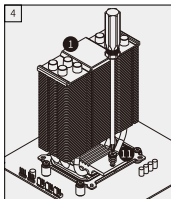

Apply a thin layer of thermal grease to the CPU and then secure the heatsink with the tightening nuts. Finish the installation by connecting the fan cable to "CPU_FAN" header.

Motherboard ARGB Sync (for ARGB edition only)

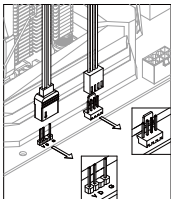

Motherboard ARGB Headers:



ASUS: ADD_HEADER



MSI: JRAINBOW



GIGABYTE: D_LED



ASROCK: ADDR_LED

Secure the fan to the heatsink with fan clips.

(For motherboard ARGB control): plug fan ARGB 3pin cable to 5V ARGB header on the motherboard. Then download correct software from motherboard official website and use the software to control the ARGB lighting.

If You Have Questions,

1. Please ask for professional help if you don't know how to install.
2. Make sure you're working on a power-off PC.
3. If you have any doubt about components list or product itself, please contact your original reseller/retailer/etailer.
4. ID-COOLING is always ready to offer our support. You can find the contact information below.
5. Descriptions are for your reference. Different models may vary in terms of components list.

SHENZHEN BUYEASY CO., LTD.

www.idcooling.com

support@idcooling.com



[idcoolingglobal](https://www.facebook.com/idcoolingglobal)



[youtube.com/c/idcooling](https://www.youtube.com/c/idcooling)

Инструкция по установке

SE-214-XT / SE-903-XT Серия

20220221-V2

Комплект поставки

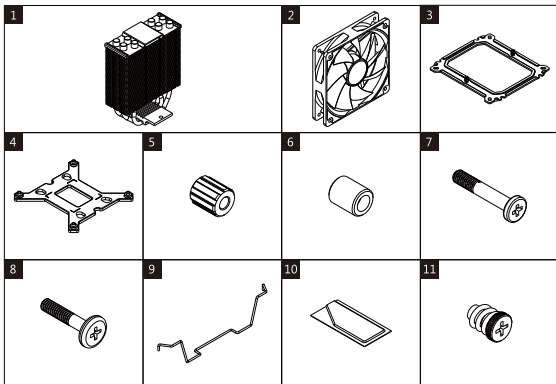

- 1) Радиатор ×1 2) Вентилятор ×1 3) Универсальное крепление ×1
4) Задняя пластина для Intel LGA1700/1200 ×1 5) Крепёжные стойки для Intel LGA1700 ×4
6) Крепёжные стойки для Intel LGA1200/115X and AMD ×4
7) Крепёжные винты для платформы Intel ×4 8) Крепёжные винты для платформы AMD ×4
9) Крепление для вентилятора ×2 10) Термопаста ×1
11) Зажимные гайки ×2

Иллюстрация универсального крепления

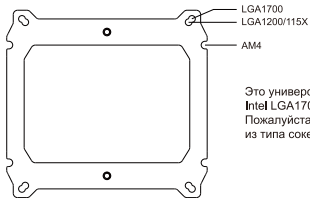

Это универсальное крепление для платформ Intel LGA1700/1200/115X и платформы AMD AM4. Пожалуйста, выберите верные отверстия исходя из типа сокета вашего процессора.

Иллюстрация задней панели Intel

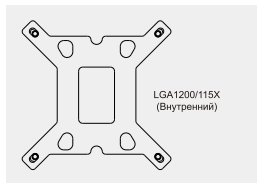
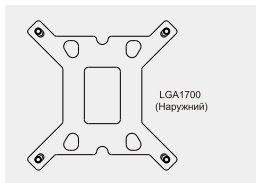

Задняя панель Intel предназначена для сокетов LGA1700 и LGA1200 / 115X. Расположите винты в нужном положении для LGA1700 и LGA1200 / 115X.

Intel LGA1700/1200/115X

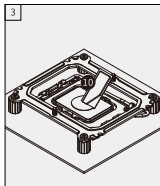
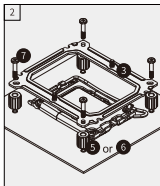
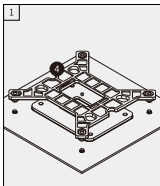

Примечание: Пожалуйста выберите правильные установочные позиции на универсальном креплении, а также, выберите правильные крепёжные стойки 9 для LGA1700/ 10 для LGA1200/115X. Установите заднюю пластину сзади материнской платы, поставьте правильные крепёжные стойки, а затем закрепите универсальное крепление крепёжными винтами для платформы Intel.

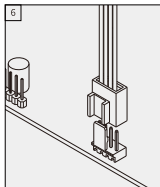
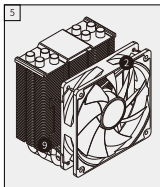
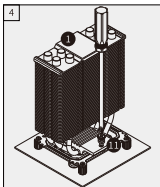

Нанесите тонкий слой термопасты на процессор а затем закрепите радиатор с помощью зажимных гаек. Закончите установку, подключив коннектор вентилятора кулера к коннектору "CPU_FAN" на материнской плате.

AMD AM5/AM4

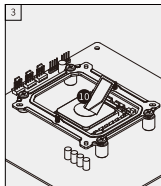
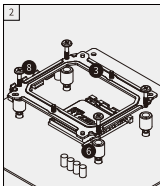
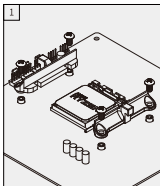

Снимите оригинальную переднюю рамку AMD, оставив заднюю пластину.
Установите крепёжные стойки и закрепите винтами для платформы AMD.

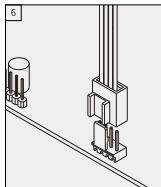
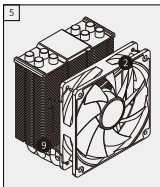
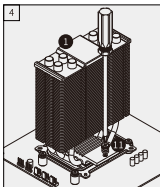

Нанесите тонкий слой термопасты на процессор а затем закрепите радиатор с помощью зажимных гаек. Закончите установку, подключив коннектор вентилятора кулера к коннектору "CPU_FAN" на материнской плате.

Motherboard ARGB Sync (Только для ARGB версии)

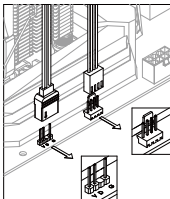

Motherboard ARGB Headers:



ASUS: ADD_HEADER



MSI: JRAINBOW



GIGABYTE: D_LED



ASROCK: ADDR_LED

Закрепите вентилятор на радиаторе зажимами для вентилятора. Подключите 4-контактный кабель питания вентилятора к разъему "CPU_FAN".
(Для управления ARGB материнской платы): подключите 3-контактный кабель ARGB вентилятора к разъему 5V ARGB на материнской плате. Затем загрузите правильное программное обеспечение с официального сайта производителя материнской платы и используйте программное обеспечение для управления освещением ARGB.

If You Have Questions,

1. Please ask for professional help if you don't know how to install.
2. Make sure you're working on a power-off PC.
3. If you have any doubt about components list or product itself, please contact your original reseller/retailer/etailer.
4. ID-COOLING is always ready to offer our support. You can find the contact information below.
5. Descriptions are for your reference. Different models may vary in terms of components list.

SHENZHEN BUYEASY CO., LTD.

www.idcooling.com

support@idcooling.com



[idcoolingglobal](https://www.facebook.com/idcoolingglobal)



[youtube.com/c/idcooling](https://www.youtube.com/c/idcooling)