

Visible Light Face Recognition Terminal Stand

Version: 1.0

1. KJL-03 (A80072852)

Size: total height length 1340mm

1.1 Channel-compatible visible light models: ProFace X [CH], SpeedFace V5L [CH].

Adaptation scenario: The customer has placed an order to receive the channel version of the device, and later wants to change the usage scenario and install it directly on the ground.

Reissue KJL-03. Individually configured screws, part number **A18010101**, each with 4PCS screws.

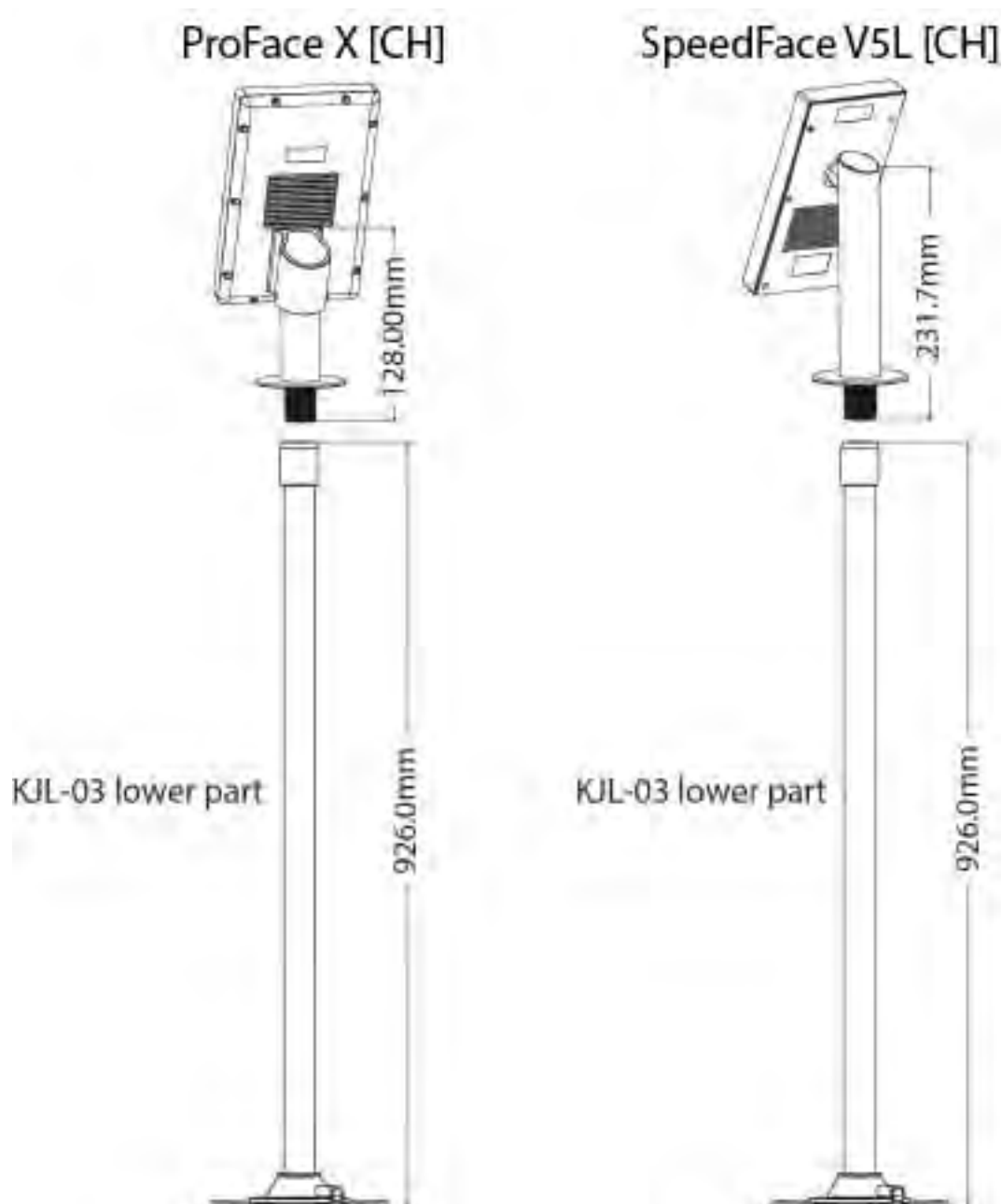

1.2 Accessible version models: SpeedFace-V5L, ProFace X renderings are as follows.

Note: You need to configure screws separately, part number **A18010101**, each with 4PCS screws.



ProFace X [CH]

SpeedFace V5L [CH]

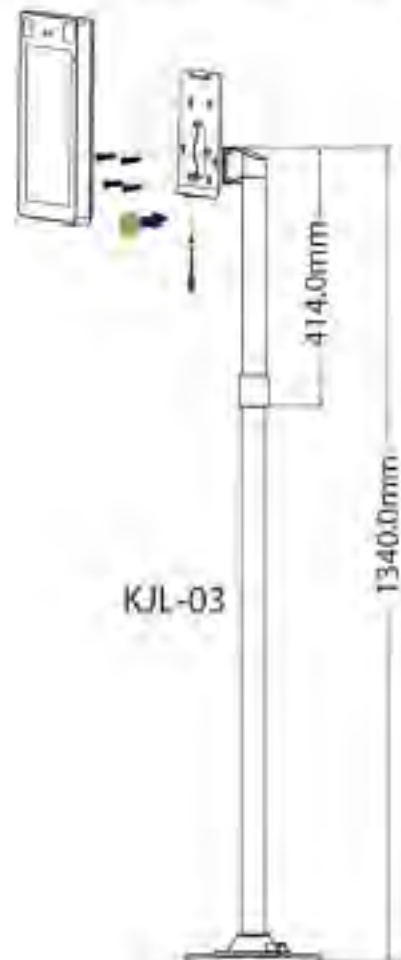

2. KJZ-03 (A80072766)

The customer wants the devices to be integrated on the gate and directly issued KJZ-03.

Adaptable models: SpeedFace-V5L, ProFace X. The effect diagram is as follows.

Note: You need to configure screws separately, part number **A18010101**, each with 4PCS screws.

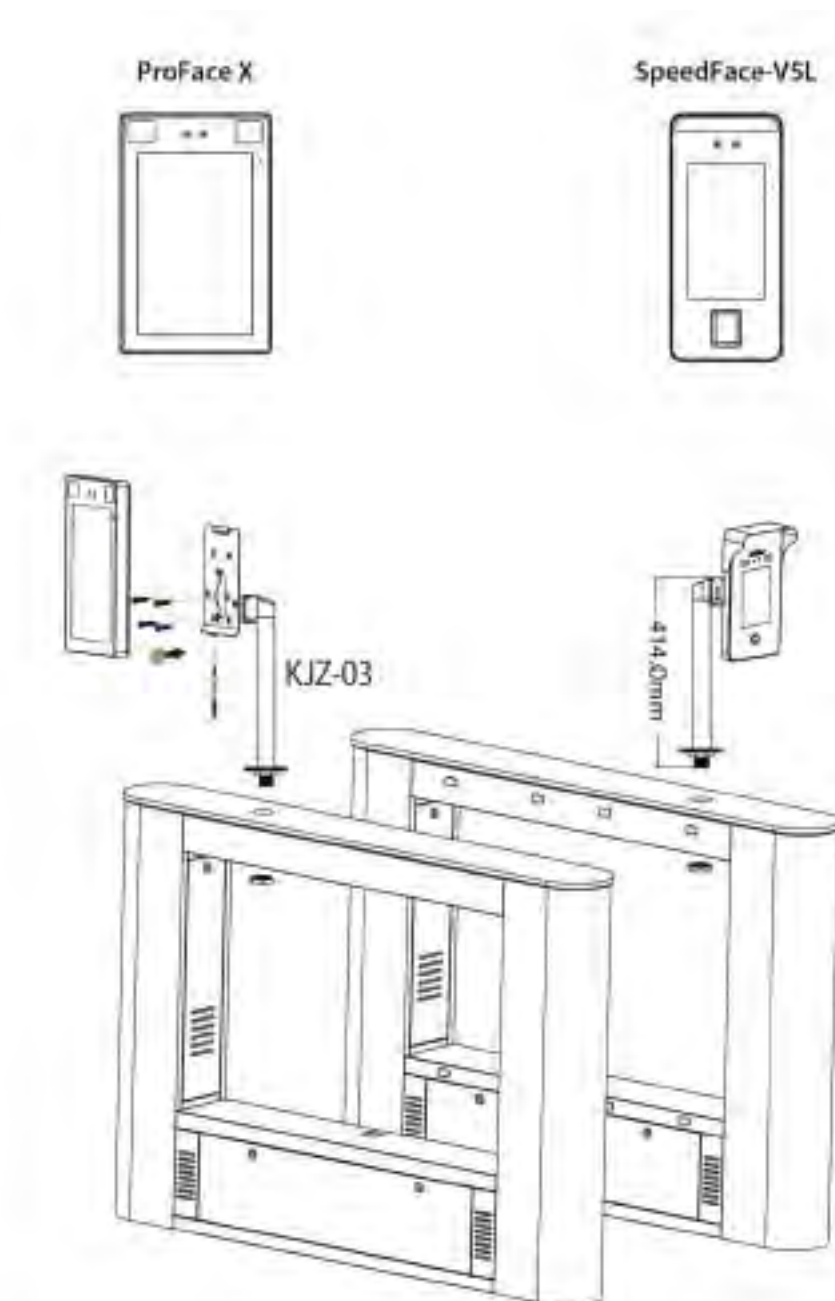

3. KJZ-03 Extension bar (A13130130)

Use scenario: The customer has placed an order for our bracket and machine, and found that the length of the bracket does not match the actual installation environment during the installation process; order directly to reissue KJZ-03 extension bar.

Extendable bracket: For ProFace X [CH] and SpeedFace-V5L [CH] channel version bracket. The effect diagram is as follows.

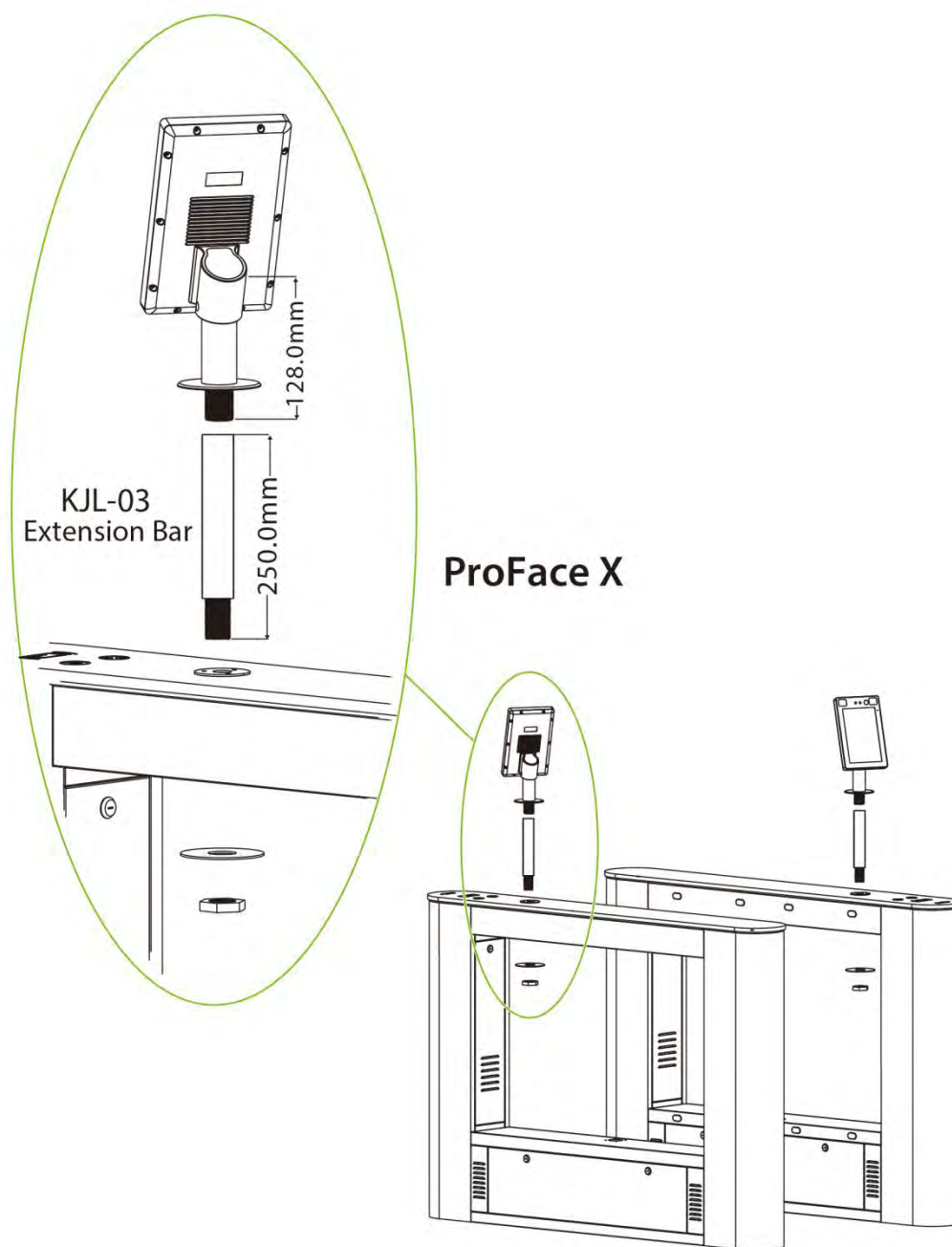

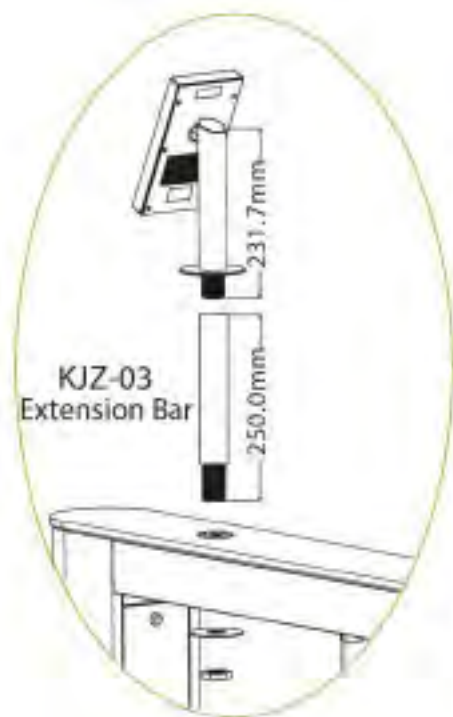

ProFace X [CH]

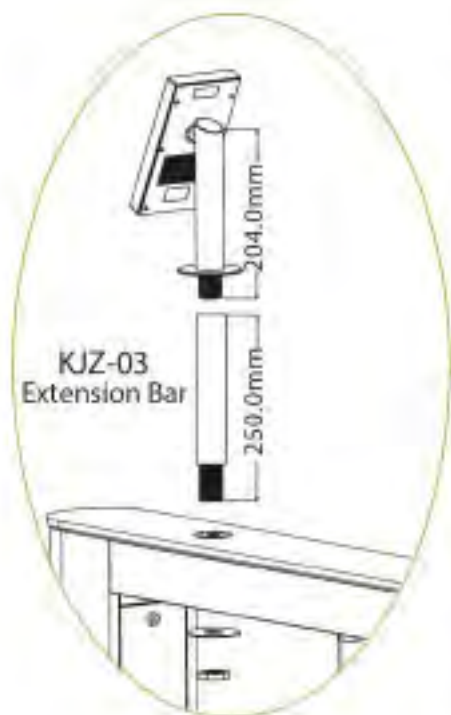
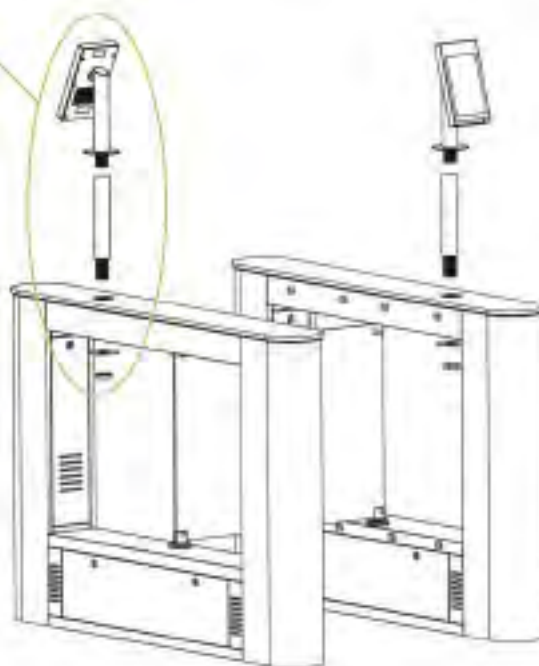

SpeedFace V5L [CH]



ZK Building, Wuhe Road, Gangtou, Bantian, Buji Town,
Longgang District, Shenzhen China 518129

Tel: +86 755-89602345

Fax: +86 755-89602394

www.zkteco.com



Copyright©2019 ZKTECO CO., LTD. All rights reserved.