

ワイパーブレードをインストール手順  
WIPER BLADE INSTALLATION INSTRUCTIONS

**LYNX**<sup>®</sup>  
SPARE PARTS *avto*

**HOOK**

1

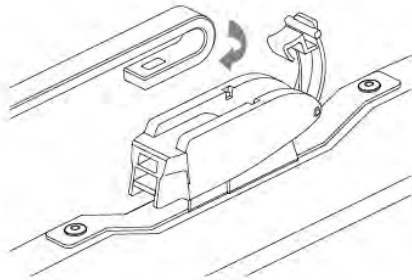

2

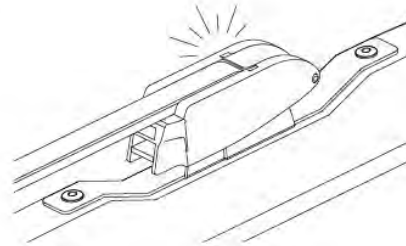

**SIDE PIN**

1

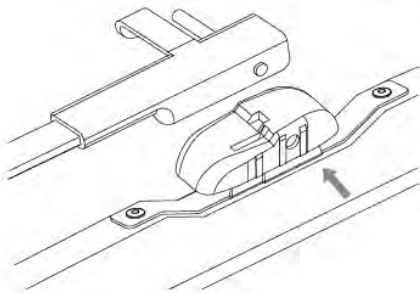

2

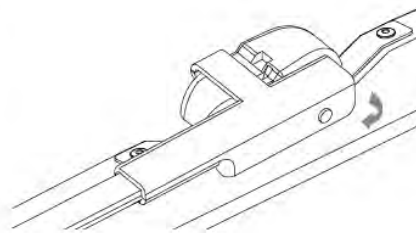

**PUSH BUTTON 16 mm**

1

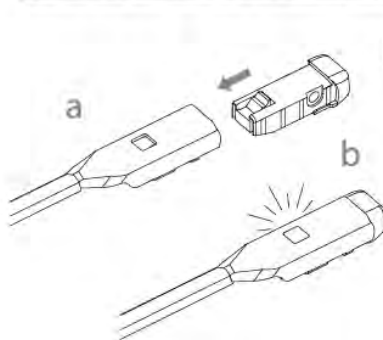

2

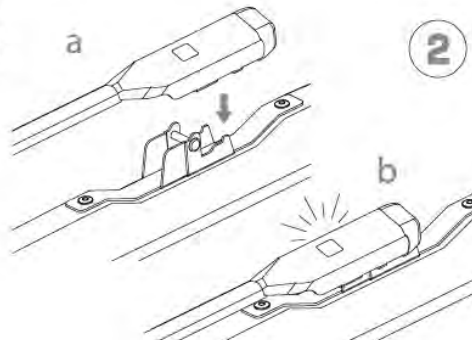

ワイパーブレードをインストール手順  
WIPER BLADE INSTALLATION INSTRUCTIONS

**LYNX**<sup>®</sup>  
SPARE PARTS *avto*

**PUSH BUTTON 19 mm**

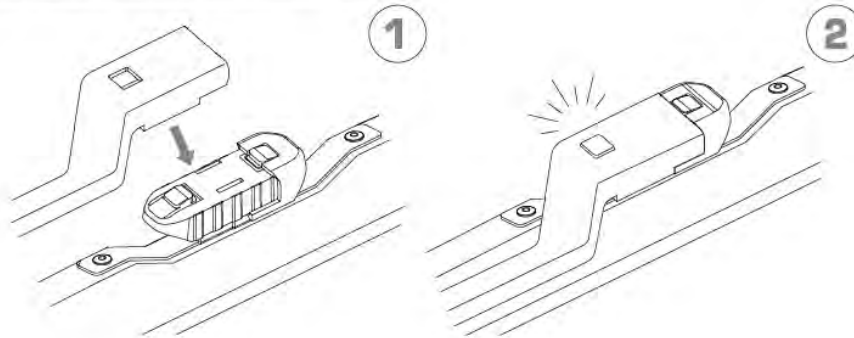

**BAYONET**

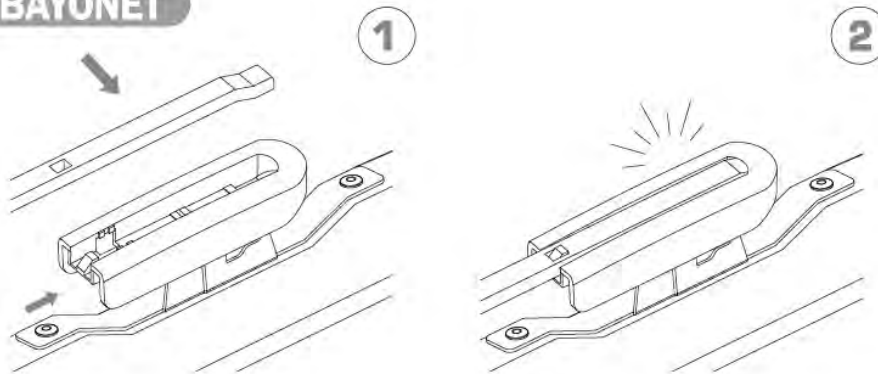

**PINCH TAB**

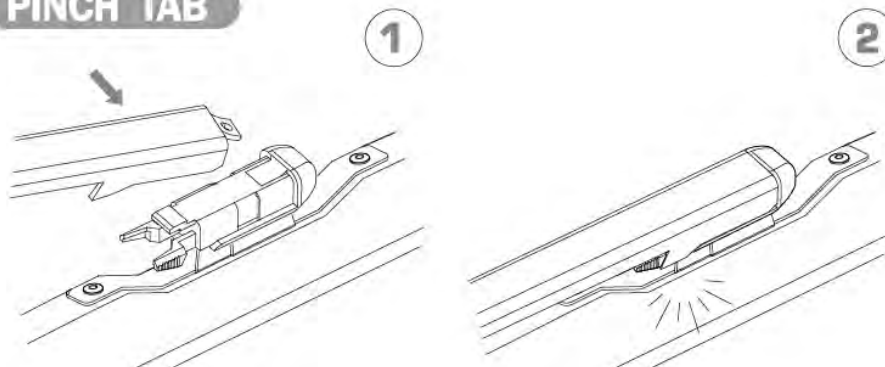

# ワイパーブレードをインストール手順 WIPER BLADE INSTALLATION INSTRUCTIONS

**LYNX**<sup>®</sup>  
SPARE PARTS *avto*

