

Digital VTH (Version 4.7)

User's Manual







V1.0.2

Foreword

This manual introduces the structure and configuration of digital VTH. Read carefully before using the VTH, and keep the manual safe for future reference.

Safety Instructions

The following signal words might appear in the manual.

Signal Words	Meaning
 DANGER	Indicates a high potential hazard which, if not avoided, will result in death or serious injury.
 WARNING	Indicates a medium or low potential hazard which, if not avoided, could result in slight or moderate injury.
 CAUTION	Indicates a potential risk which, if not avoided, could result in property damage, data loss, reductions in performance, or unpredictable results.
 TIPS	Provides methods to help you solve a problem or save time.
 NOTE	Provides additional information as a supplement to the text.

Revision History

Version	Revision Content	Release Time
V1.0.2	Added new model.	November 2023
V1.0.1	Added new model.	September 2023
V1.0.0	First release.	August 2023

Privacy Protection Notice

As the device user or data controller, you might collect the personal data of others such as their face, audio, fingerprints, and license plate number. You need to be in compliance with your local privacy protection laws and regulations to protect the legitimate rights and interests of other people by implementing measures which include but are not limited: Providing clear and visible identification to inform people of the existence of the surveillance area and provide required contact information.

About the Manual

- The manual is for reference only. Slight differences might be found between the manual and the product.
- We are not liable for losses incurred due to operating the product in ways that are not in compliance with the manual.

- The manual will be updated according to the latest laws and regulations of related jurisdictions. For detailed information, see the paper user's manual, use our CD-ROM, scan the QR code or visit our official website. The manual is for reference only. Slight differences might be found between the electronic version and the paper version.
- All designs and software are subject to change without prior written notice. Product updates might result in some differences appearing between the actual product and the manual. Please contact customer service for the latest program and supplementary documentation.
- There might be errors in the print or deviations in the description of the functions, operations and technical data. If there is any doubt or dispute, we reserve the right of final explanation.
- Upgrade the reader software or try other mainstream reader software if the manual (in PDF format) cannot be opened.
- All trademarks, registered trademarks and company names in the manual are properties of their respective owners.
- Please visit our website, contact the supplier or customer service if any problems occur while using the device.
- If there is any uncertainty or controversy, we reserve the right of final explanation.

Important Safeguard and Warnings

This section introduces content covering the proper handling of the device, hazard prevention, and prevention of property damage. Read carefully before using the device, and comply with the guidelines when using it.

Operation Requirements



- Check whether the power supply is correct before use.
- Do not unplug the power cord on the side of the device while the adapter is powered on.
- Operate the device within the rated range of power input and output.
- Transport, use and store the device under allowed humidity and temperature conditions.
- If the device is powered off for longer than a month, it should be placed in its original package and sealed. Make sure to keep it away from moisture, and store it under allowed humidity and temperature conditions.
- Do not drop or splash liquid onto the device, and make sure that there is no object filled with liquid on the device to prevent liquid from flowing into it.
- Do not disassemble the device without professional instruction.

Installation Requirements



WARNING

- Do not connect the power adapter to the device while the adapter is powered on.
- Strictly comply with the local electric safety code and standards. Make sure the ambient voltage is stable and meets the power supply requirements of the device.
- Do not connect the device to two or more kinds of power supplies, to avoid damage to the device.
- Improper use of the battery might result in a fire or explosion.



- Personnel working at heights must take all necessary measures to ensure personal safety including wearing a helmet and safety belts.
- Do not place the device in a place exposed to sunlight or near heat sources.
- Keep the device away from dampness, dust, and soot.
- Install the device on a stable surface to prevent it from falling.
- Install the device in a well-ventilated place, and do not block its ventilation.
- Use an adapter or cabinet power supply provided by the manufacturer.
- Use the power cords that are recommended for the region and conform to the rated power specifications.
- The power supply must conform to the requirements of ES1 in IEC 62368-1 standard and be no higher than PS2. Please note that the power supply requirements are subject to the device label.
- The device is a class I electrical appliance. Make sure that the power supply of the device is connected to a power socket with protective earthing.

Table of Contents

Foreword.....	I
Important Safeguard and Warnings.....	III
1 Product Overview.....	1
1.1 Front Panel.....	1
1.1.1 VTH2421F Series.....	1
1.1.2 VTH2611L/2612L Series.....	2
1.1.3 VTH2621G/VTH2622G Series.....	3
1.1.4 VTH2624G Series.....	4
1.1.5 VTH5221D Series.....	5
1.1.6 VTH5241D Series.....	6
1.1.7 VTH5421E Series.....	7
1.1.8 VTH5421H/VTH5422H Series.....	8
1.1.9 VTH5441G Series.....	9
1.1.10 VTH8621K/VTH8622K/VTH8641K/VTH8642K Series.....	10
1.2 Rear Panel.....	10
1.2.1 VTH2421F Series.....	11
1.2.2 VTH2611L/2612L Series.....	12
1.2.3 VTH2621G Series.....	13
1.2.4 VTH2622G Series.....	14
1.2.5 VTH2624G Series.....	15
1.2.6 VTH5221D Series.....	17
1.2.7 VTH5241D Series.....	18
1.2.8 VTH5421E Series.....	19
1.2.9 VTH5421H/VTH5422H Series.....	20
1.2.10 VTH5441G Series.....	22
1.2.11 VTH8621K/VTH8622K Series.....	23
1.2.12 VTH8641K/VTH8642K Series.....	24
1.3 Alarm Port.....	25
1.4 Function.....	25
2 VTH Initialization.....	27
2.1 Initialization through the Device.....	27
2.2 Initialization through the ConfigTool.....	33
3 VTH Screen Operation.....	34
3.1 Home Screen.....	34
3.2 Editing Home Screen.....	35
3.3 Call.....	37
3.3.1 Call Log.....	37

3.3.2	Contacts.....	37
3.3.3	Calling User.....	39
3.3.4	Call from User.....	41
3.3.5	Call from VTO.....	42
3.3.6	Calling DMSS.....	44
3.4	Information.....	45
3.4.1	Security Alarm.....	45
3.4.2	Publish Information.....	46
3.4.3	Guest Message.....	47
3.4.4	Video Pictures.....	47
3.5	Monitor.....	48
3.5.1	Monitoring VTO.....	48
3.5.2	Monitoring IPC.....	50
3.5.3	Favorites.....	53
3.6	Setting.....	54
3.6.1	Call Settings.....	54
3.6.2	Alarm Setting.....	60
3.6.3	Card Management.....	64
3.6.4	WLAN.....	65
3.6.5	Mode Setting.....	66
3.6.6	General Setting.....	67
3.6.7	System Information.....	74
3.7	Project Settings.....	76
3.7.1	Forget Password.....	76
3.7.2	Network Settings.....	76
3.7.3	Configuring VTH.....	77
3.7.4	Configuring VTO.....	79
3.7.5	Searching Devices.....	81
3.7.6	Configuring SIP Server.....	82
3.7.7	Factory Settings or Reset.....	84
3.8	QR Code.....	85
3.9	Arm and Disarm Function.....	87
3.9.1	Arm.....	87
3.9.2	Disarm.....	88
3.10	Property Management.....	88
3.11	Unlock Function.....	88
3.12	Cloud Update.....	88
4	DSS Agile VDP.....	90
4.1	Downloading the App.....	90
4.2	Registration and Login.....	90

4.3 Call Functions.....	93
4.3.1 Forwarding Calls.....	93
4.3.2 Calling Operations.....	95
4.4 Monitoring.....	96
4.5 Call Records.....	99
4.6 Message.....	100
4.7 Visitor.....	103
4.7.1 Creating Pass.....	104
4.7.2 Visit Records.....	106
4.8 Setting.....	107
5 DMSS App.....	109
5.1 Downloading DMSS.....	109
5.2 Registration and Login.....	109
5.3 Adding VTH to DMSS.....	111
5.4 Configuring Arm and Disarm.....	113
5.5 DMSS Calling VTH.....	115
5.6 DMSS Calling VTO.....	116
5.7 DMSS Unlocking Door.....	117
5.8 DMSS Monitoring VTO.....	118
5.9 Viewing Alarm Information.....	120
5.10 Device Sharing.....	120
Appendix 1 Cybersecurity Recommendations.....	125

1 Product Overview



The following front and rear panel figures are for reference only.

1.1 Front Panel

1.1.1 VTH2421F Series

Figure 1-1 Front panel

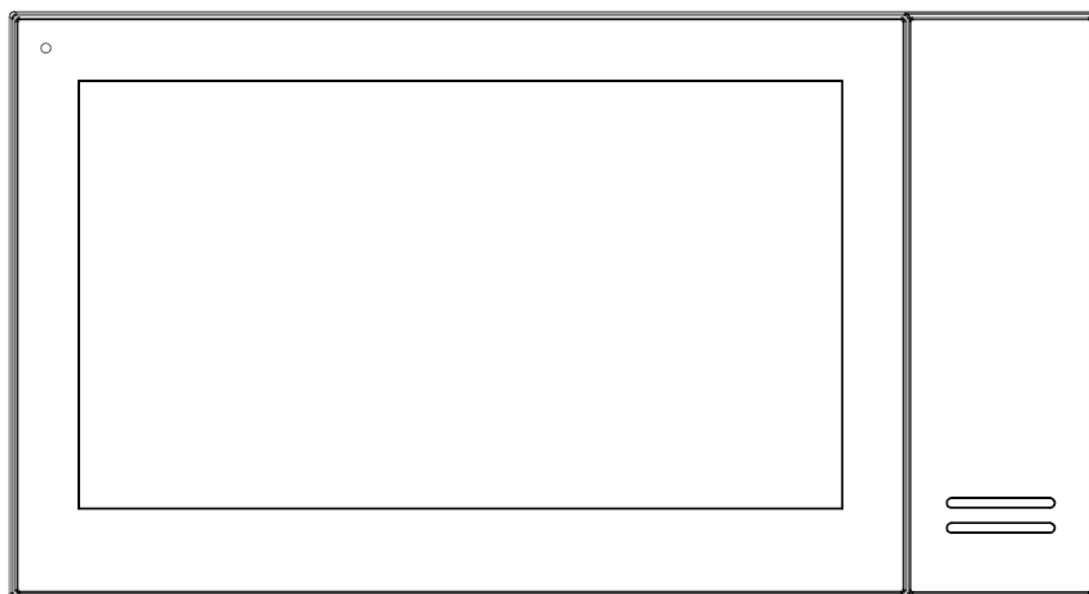

1.1.2 VTH2611L/2612L Series

Figure 1-2 Front panel

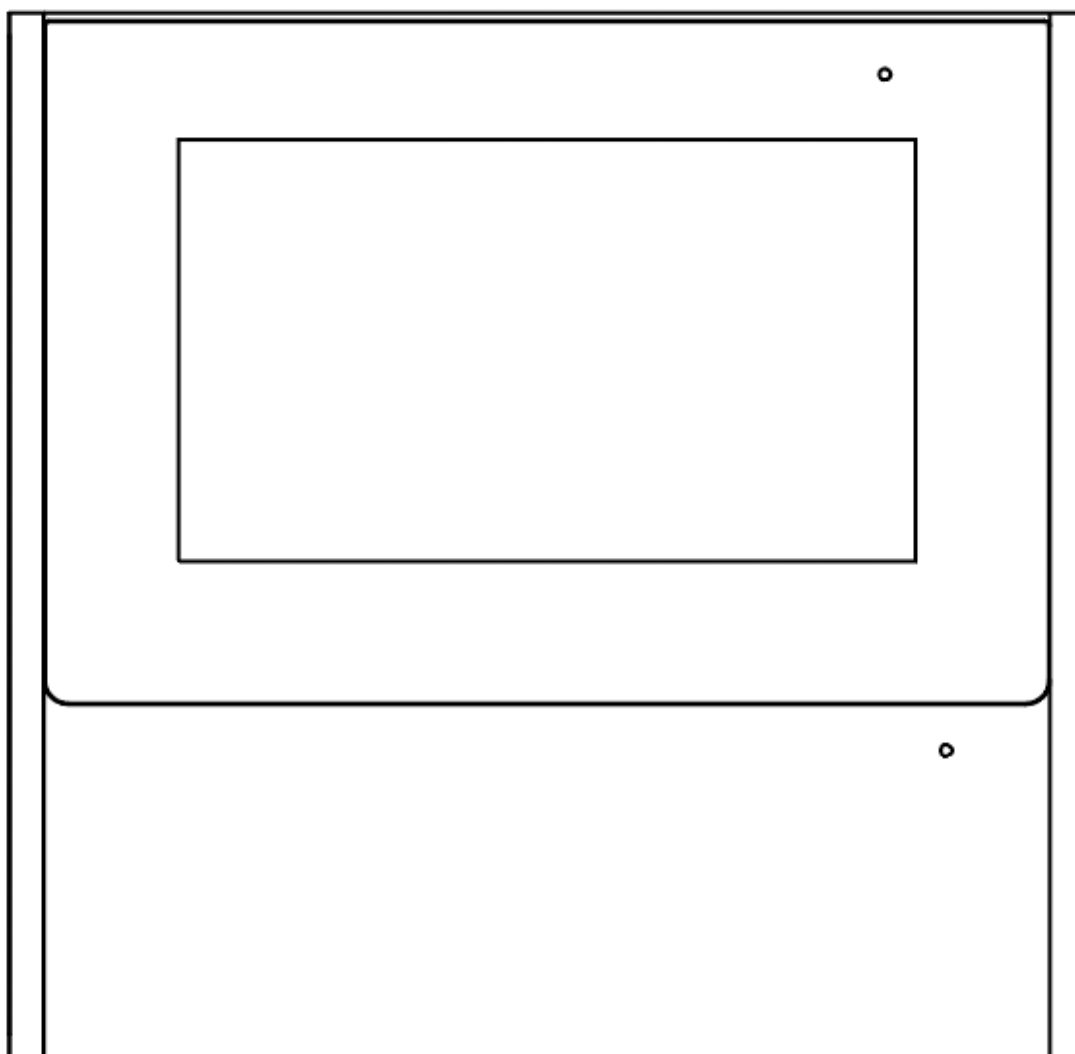

1.1.3 VTH2621G/VTH2622G Series

Figure 1-3 Front panel

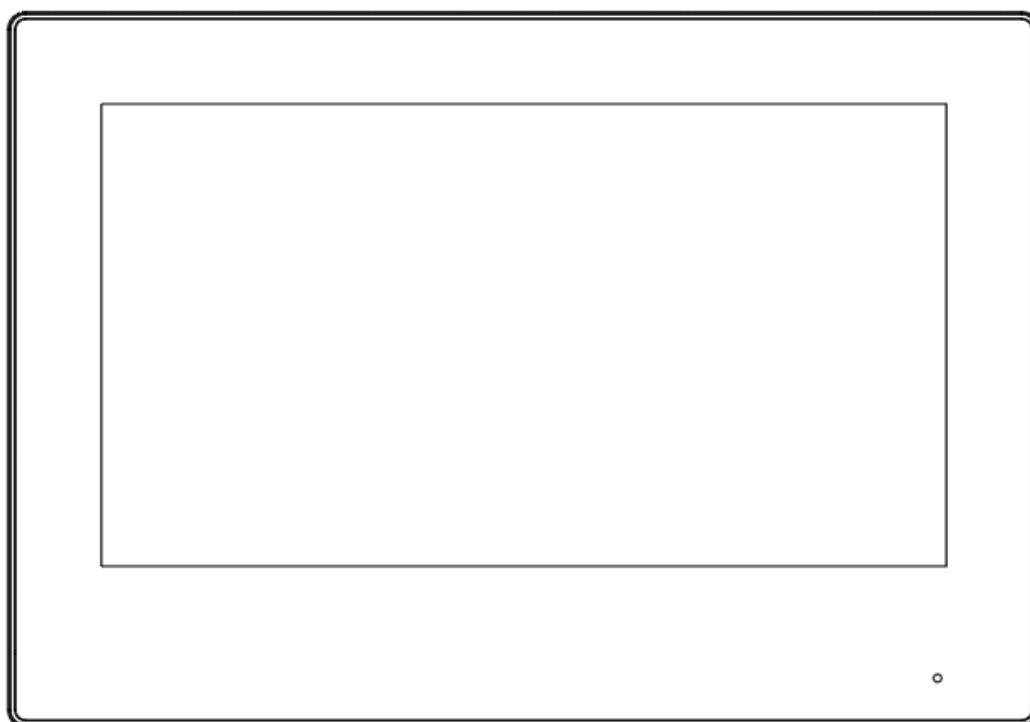

1.1.4 VTH2624G Series

Figure 1-4 Front panel

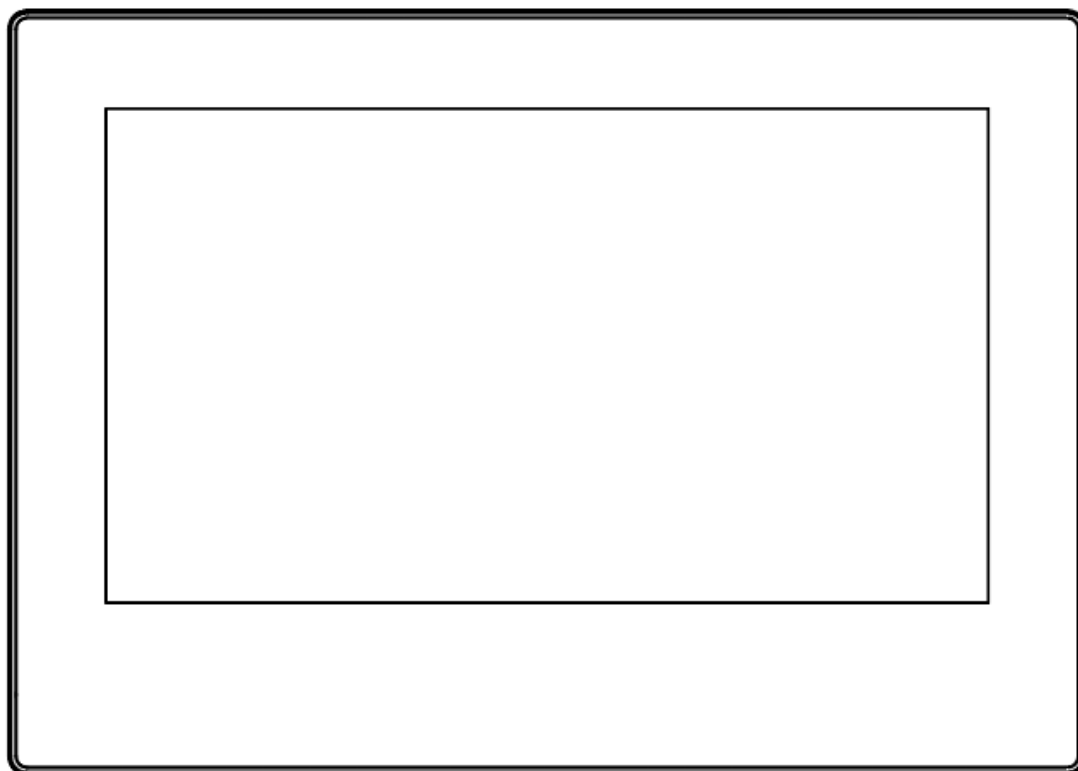

1.1.5 VTH5221D Series

Figure 1-5 Front panel

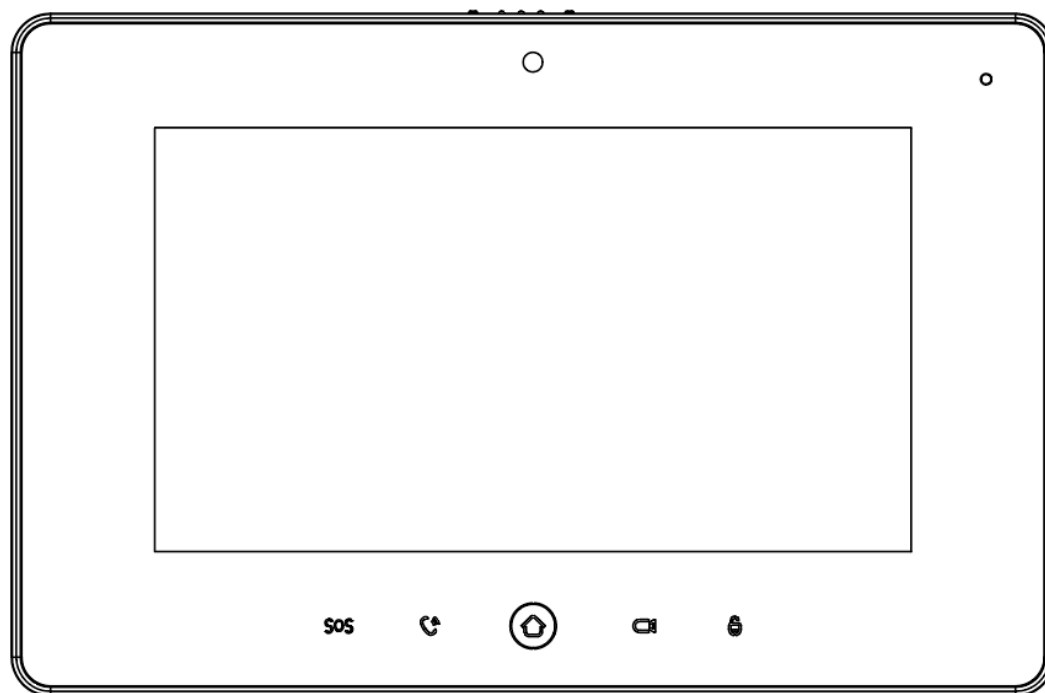





Table 1-1 Icon description

Icon	Name	Description
SOS	SOS	Emergency call.
	Call	<ul style="list-style-type: none">• Answer call.• During call, press to hang up.• During monitoring, press to speak to unit VTO, villa VTO, fence station and verifying VTO.• During speaking, press to exit speaking.
	Menu	Go to main menu.
	Monitor	<ul style="list-style-type: none">• In standby mode, press to monitor the main VTO.• During monitoring, press to exit monitoring.
	Unlock	When calling, talking, monitoring and speaking to VTO, press to unlock corresponding VTO.

1.1.6 VTH5241D Series

Figure 1-6 Front panel

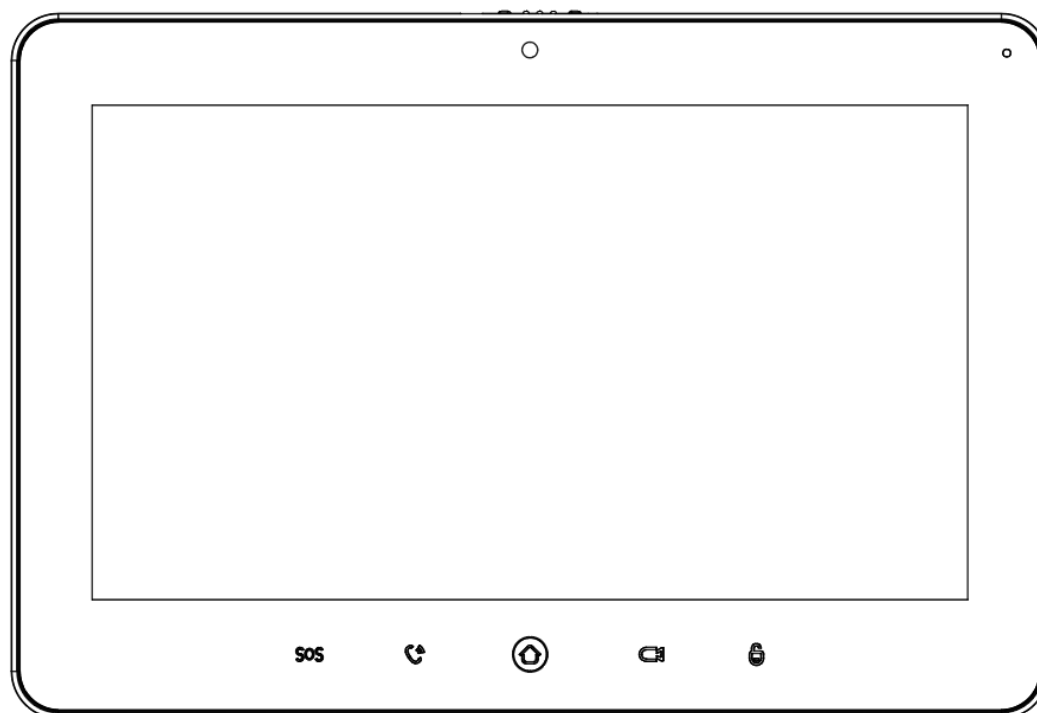



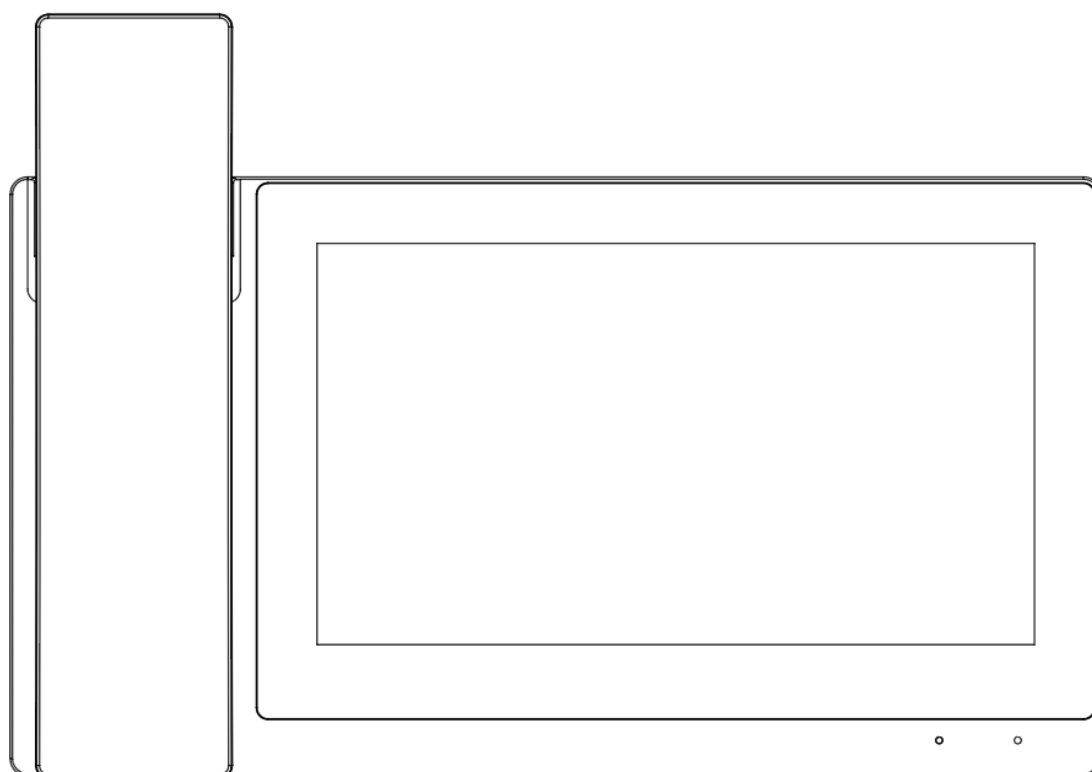

Table 1-2 Icon description

Icon	Name	Description
SOS	SOS	Emergency call.
	Call	<ul style="list-style-type: none">• Answer call.• During call, press to hang up.• During monitoring, press to speak to unit VTO, villa VTO, fence station and verifying VTO.• During speaking, press to exit speaking.
	Menu	Go to main menu.
	Monitor	<ul style="list-style-type: none">• In standby mode, press to monitor the main VTO.• During monitoring, press to exit monitoring.
	Unlock	When calling, talking, monitoring and speaking to VTO, press to unlock corresponding VTO.

1.1.7 VTH5421E Series

Figure 1-7 Front panel



1.1.8 VTH5421H/VTH5422H Series

Figure 1-8 Front panel

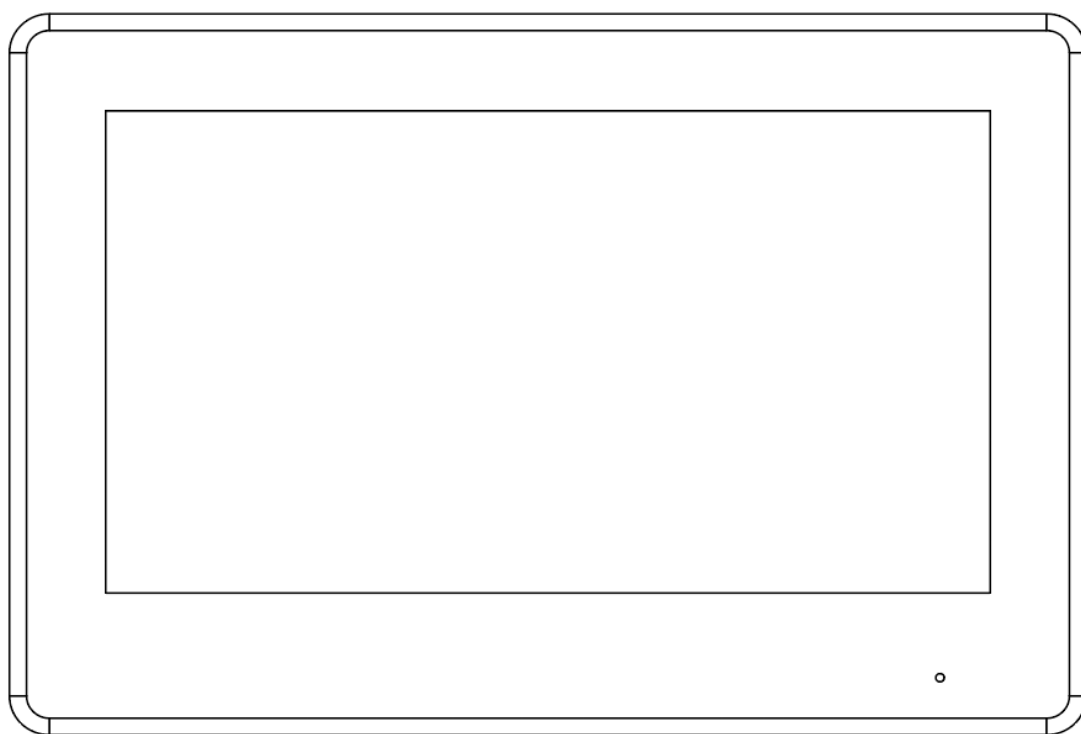

1.1.9 VTH5441G Series

Figure 1-9 Front panel

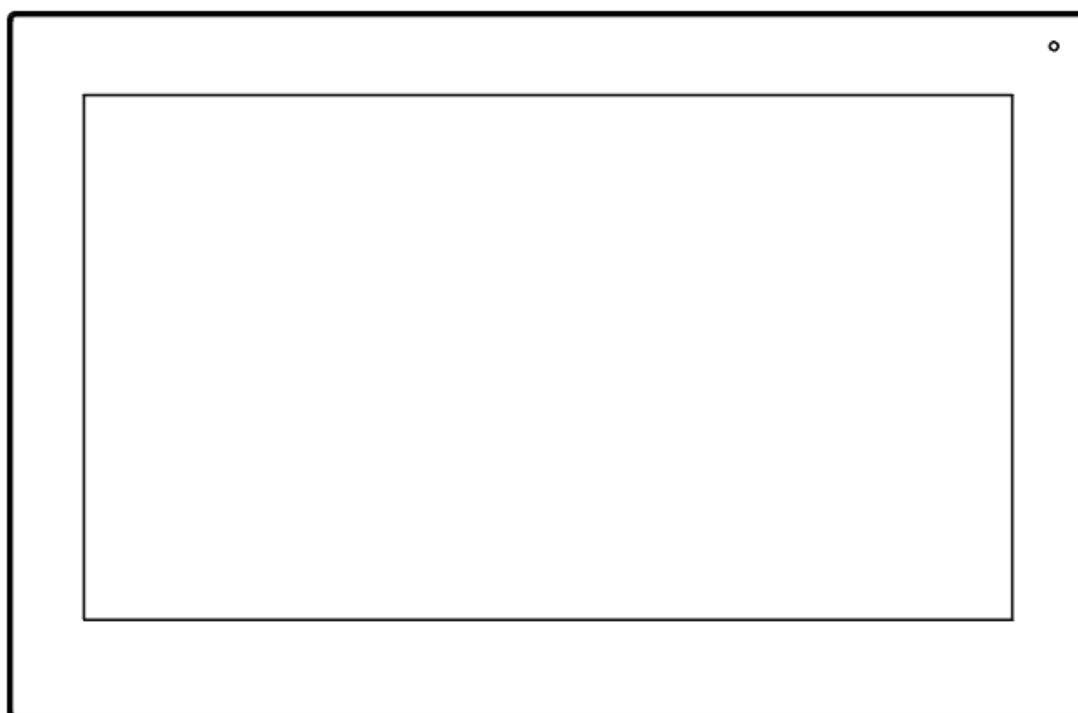

1.1.10 VTH8621K/VTH8622K/VTH8641K/VTH8642K Series

Figure 1-10 Front panel

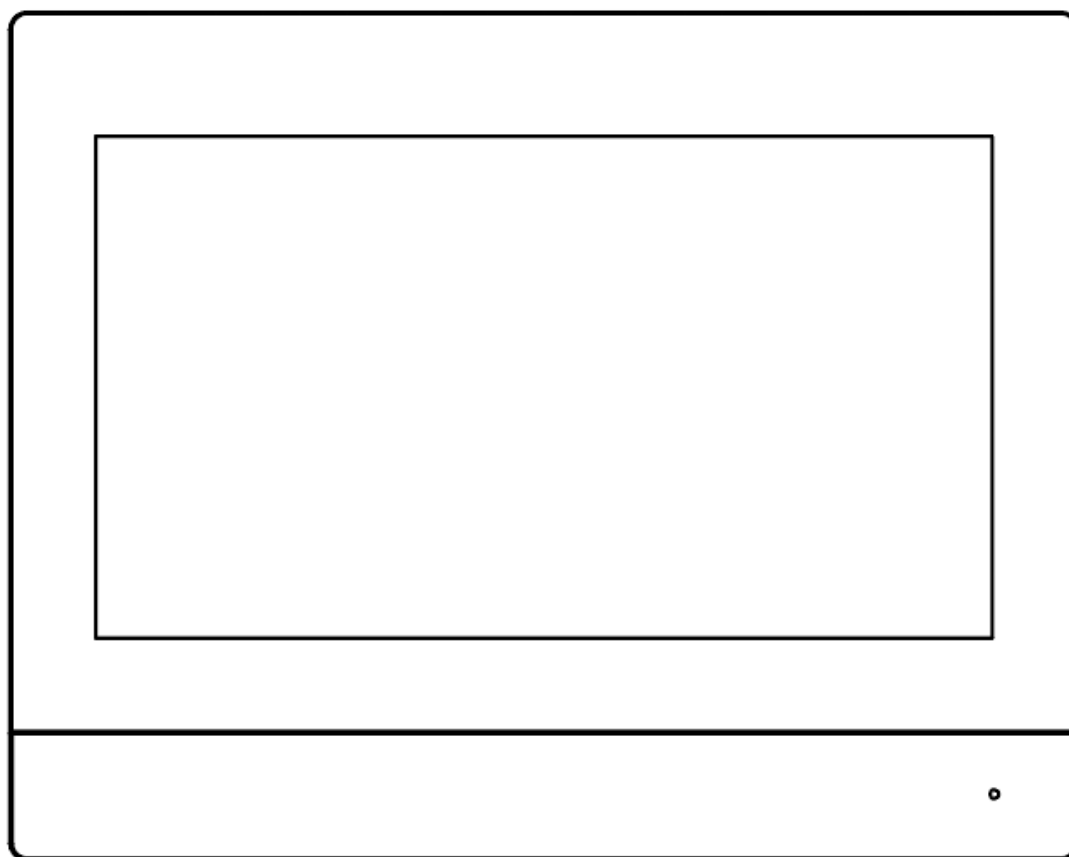

1.2 Rear Panel

Port positions at the rear panel may differ depending on the actual product. For details about the alarm port, see "1.3 Alarm Port".

1.2.1 VTH2421F Series

Figure 1-11 Rear panel

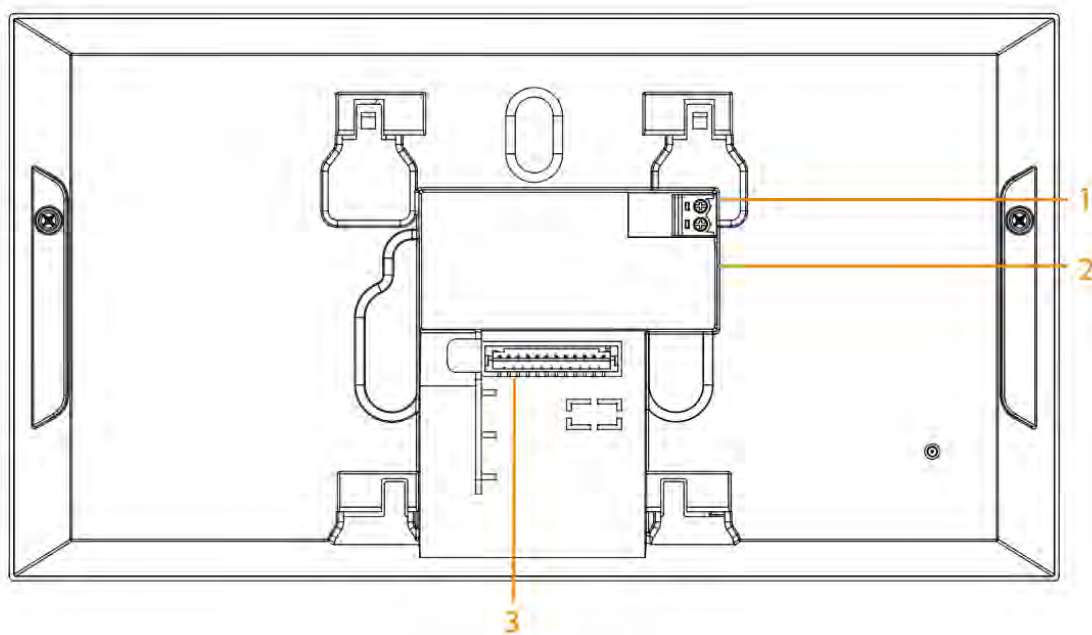

Table 1-3 Rear panel description

No.	Port
1	Power port
2	Network port
3	Alarm port

1.2.2 VTH2611L/2612L Series

Figure 1-12 Rear panel

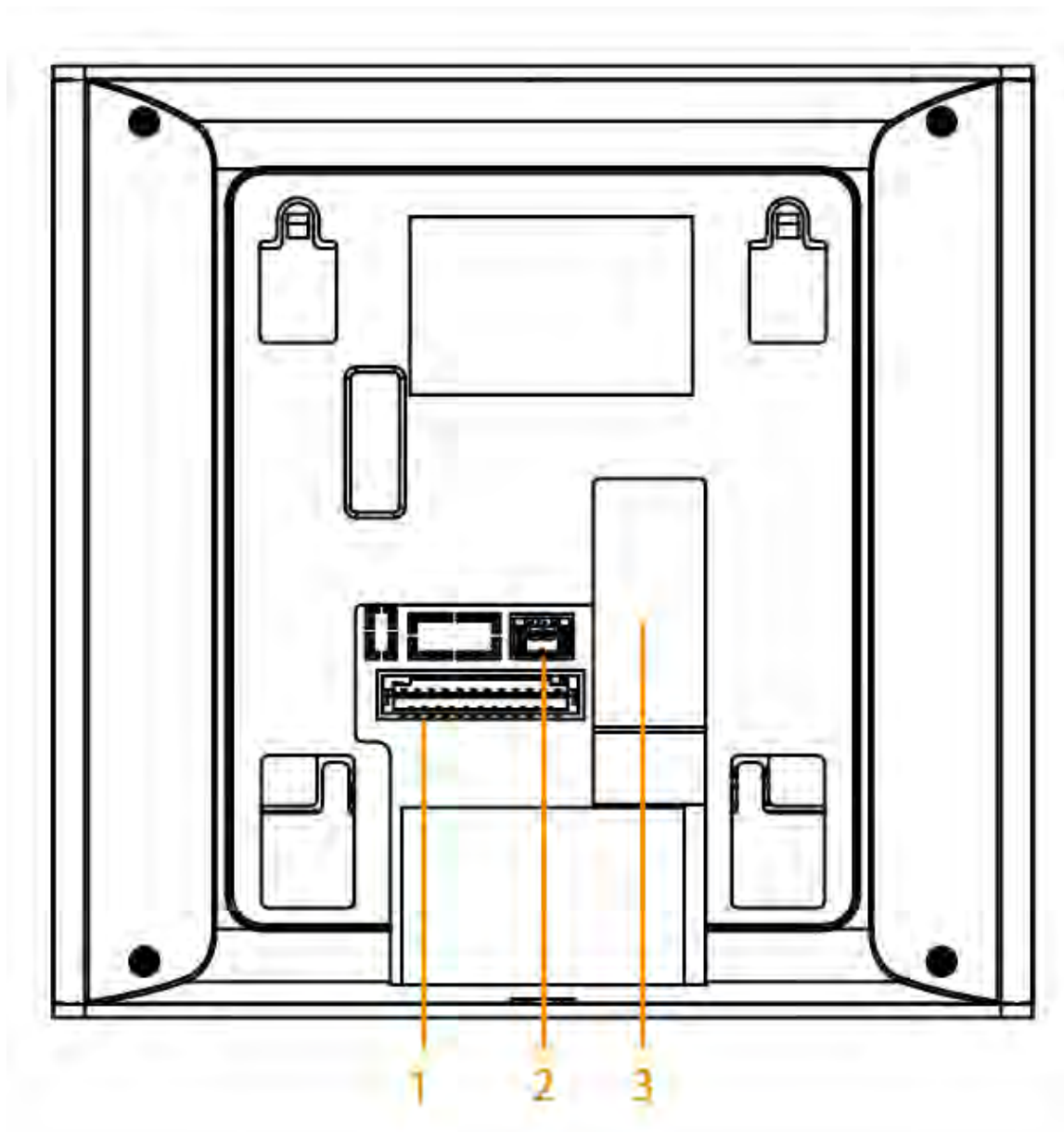

Table 1-4 Rear panel description

No.	Port
1	Alarm port
2	<ul style="list-style-type: none">• 2611L: Power input port• 2612L: 2-wire port
3	Network port

1.2.3 VTH2621G Series

Figure 1-13 Rear panel (non 2-wire)

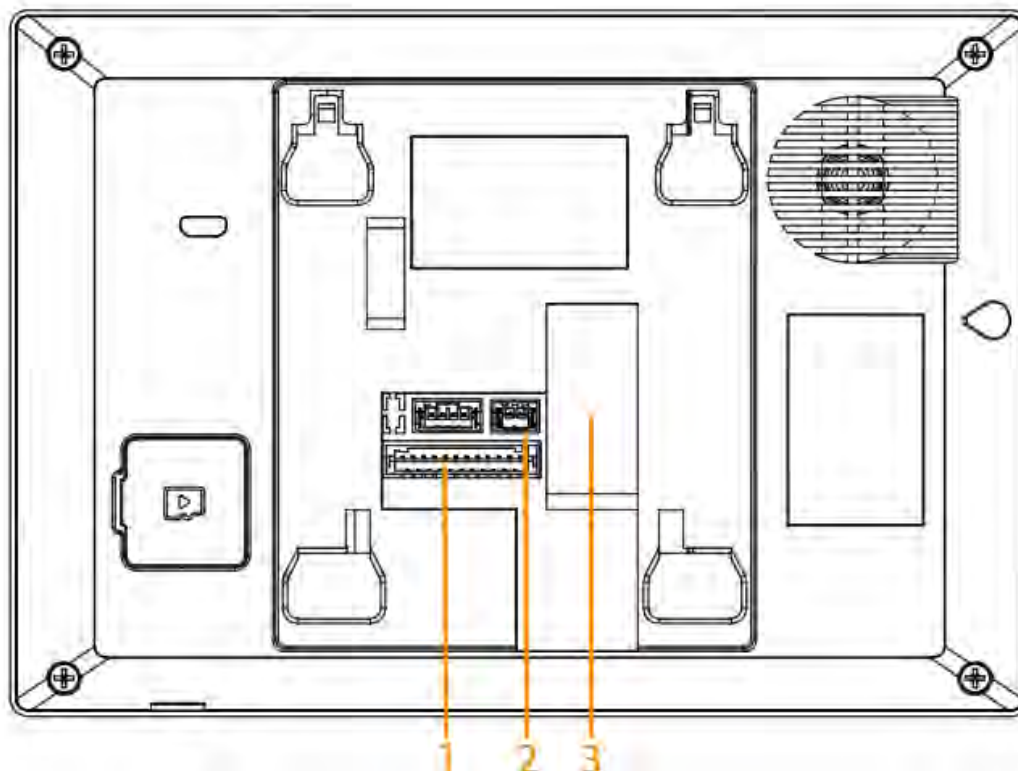

Table 1-5 Rear panel description

No.	Port
1	Alarm port
2	Power input port
3	Network port

1.2.4 VTH2622G Series

Figure 1-14 Rear panel (2-wire)

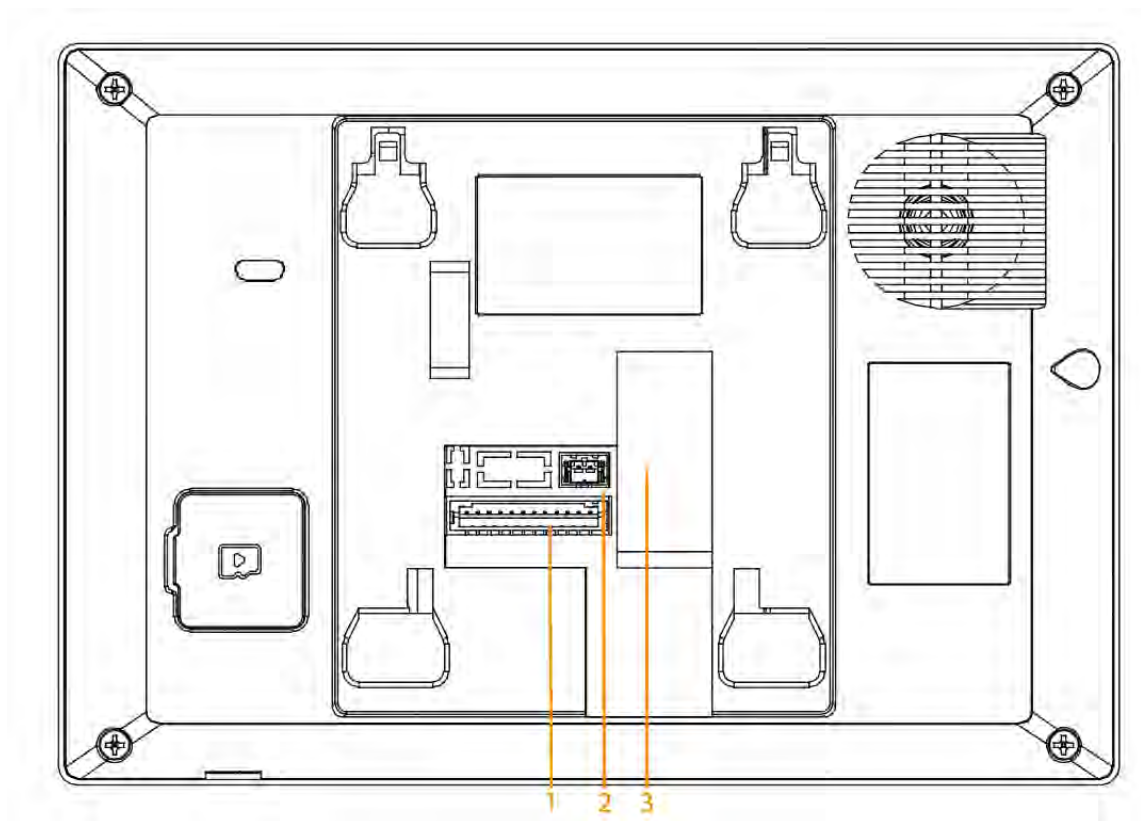

Table 1-6 Rear panel description

No.	Port
1	Alarm port
2	Power port
3	Network port

1.2.5 VTH2624G Series

Figure 1-15 Rear panel

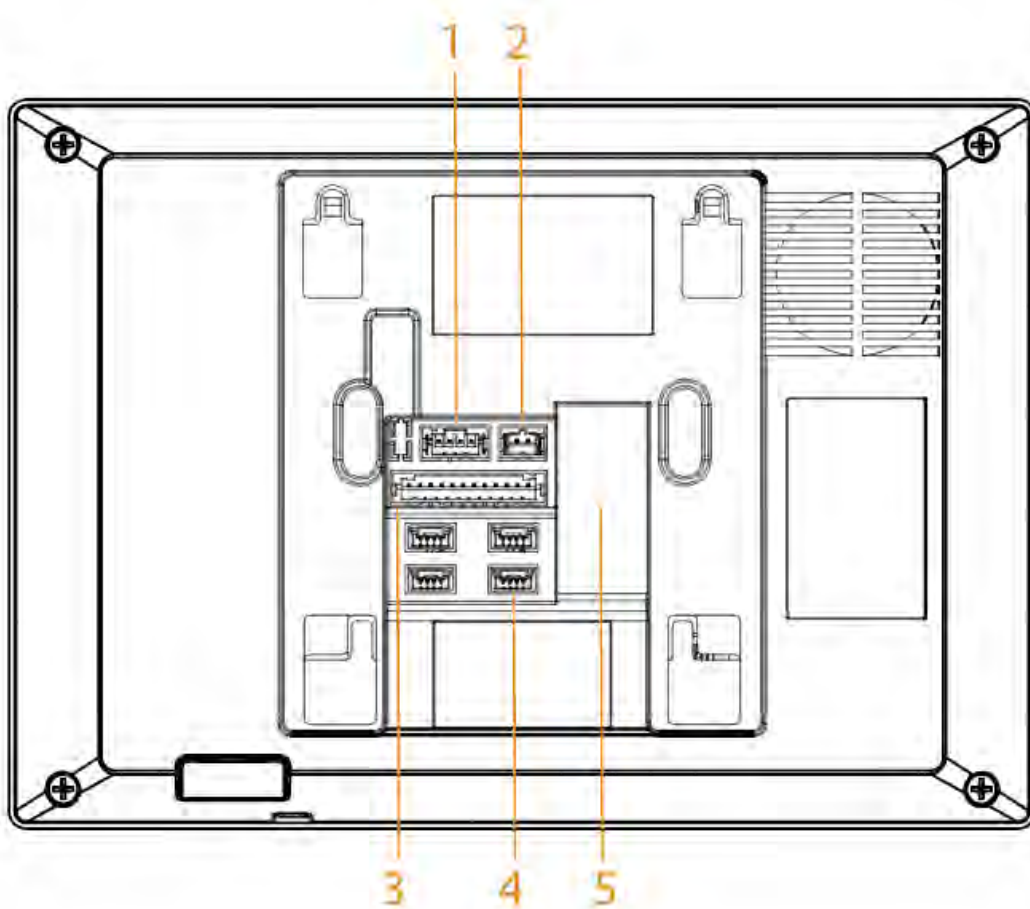

Table 1-7 Rear panel description

No.	Port
1	RS-485 port
2	Power port
3	Alarm port
4	4-wire port
5	Network port

Figure 1-16 4-wire port of VTH

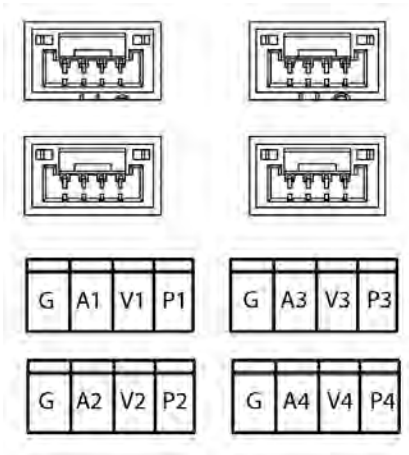

Table 1-8 Port description

Port	Description
G	Connect to the GND port of VTO.
A	Connect to the audio port of VTO.
V	Connect to the video port of VTO.
P	Connect to the power port of VTO.

1.2.6 VTH5221D Series

Figure 1-17 Rear panel

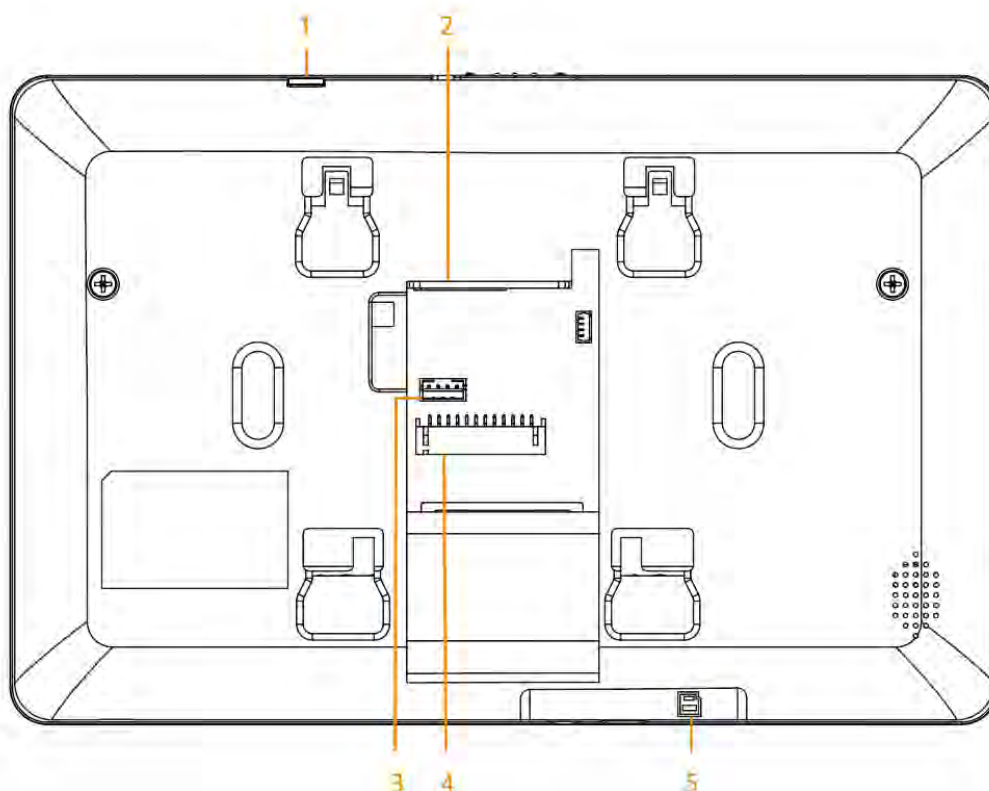
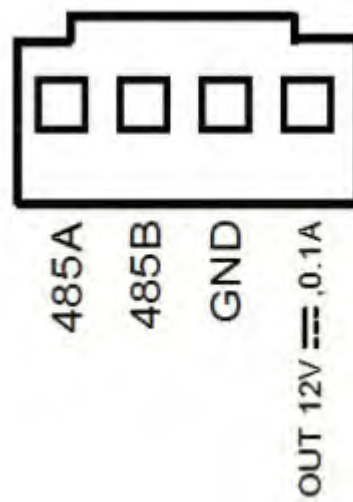

Table 1-9 Rear panel description

No.	Port
1	Reset button
2	Network port
3	RS-485 extended port
4	Alarm port
5	SD card slot

Figure 1-18 RS-485 extended port



1.2.7 VTH5241D Series

Figure 1-19 Rear panel

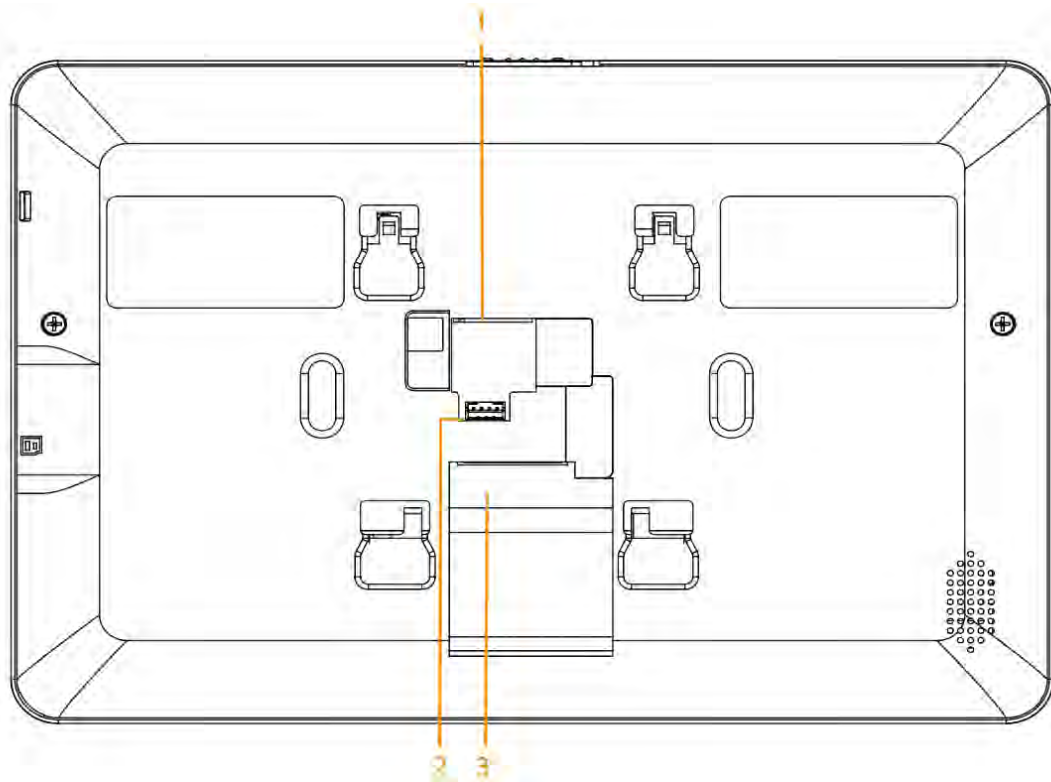
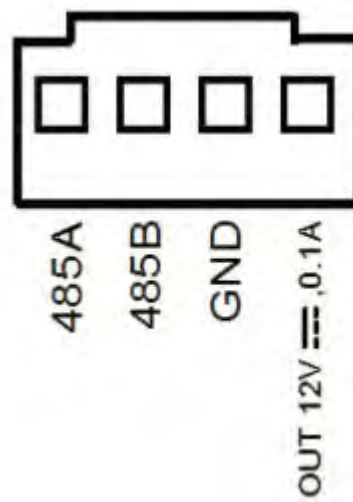

Table 1-10 Rear panel description

No.	Port
1	Network port
2	RS-485 extended port
3	Alarm port

Figure 1-20 RS-485 extended port



1.2.8 VTH5421E Series

Figure 1-21 Rear panel

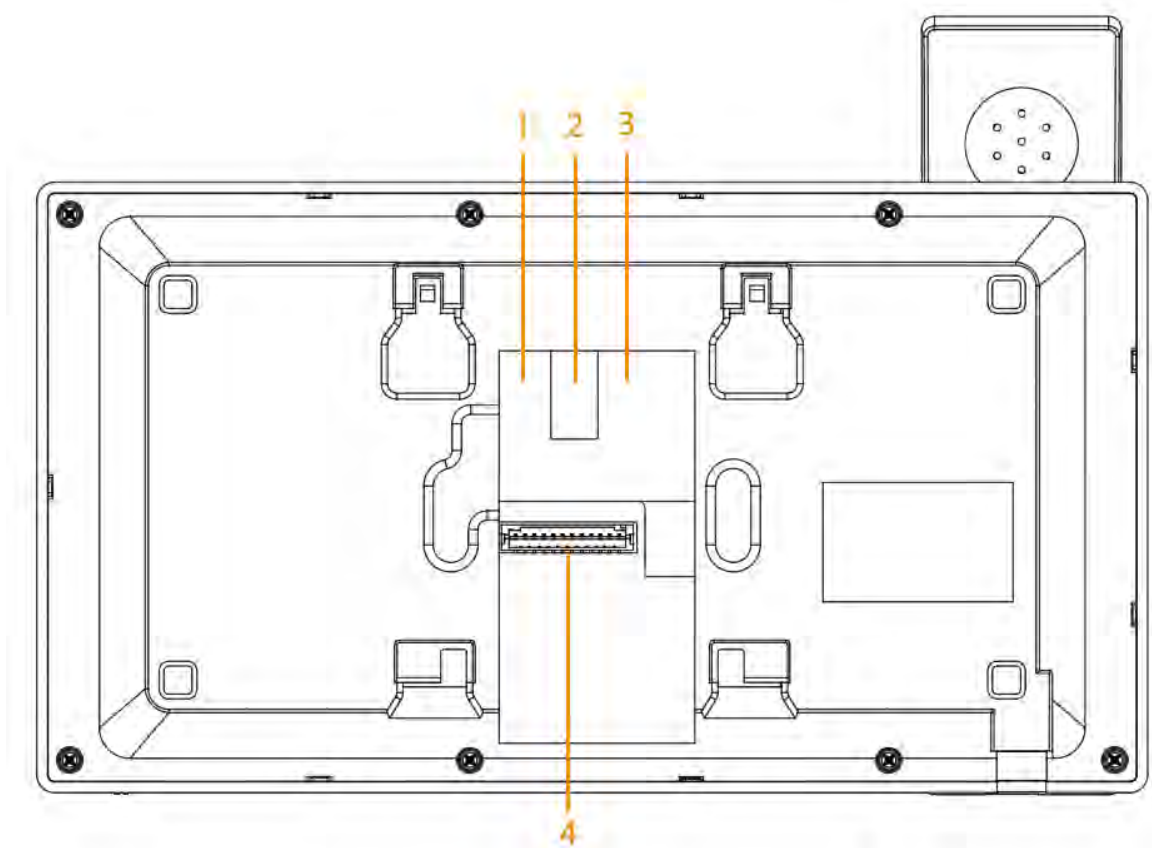
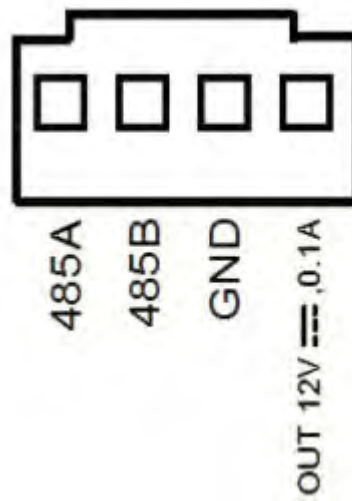

Table 1-11 Rear panel description

No.	Port
1	RS-485 extended port

No.	Port
2	Power port
3	Network port
4	Alarm port

Figure 1-22 RS-485 extended port



1.2.9 VTH5421H/VTH5422H Series

Figure 1-23 Rear panel

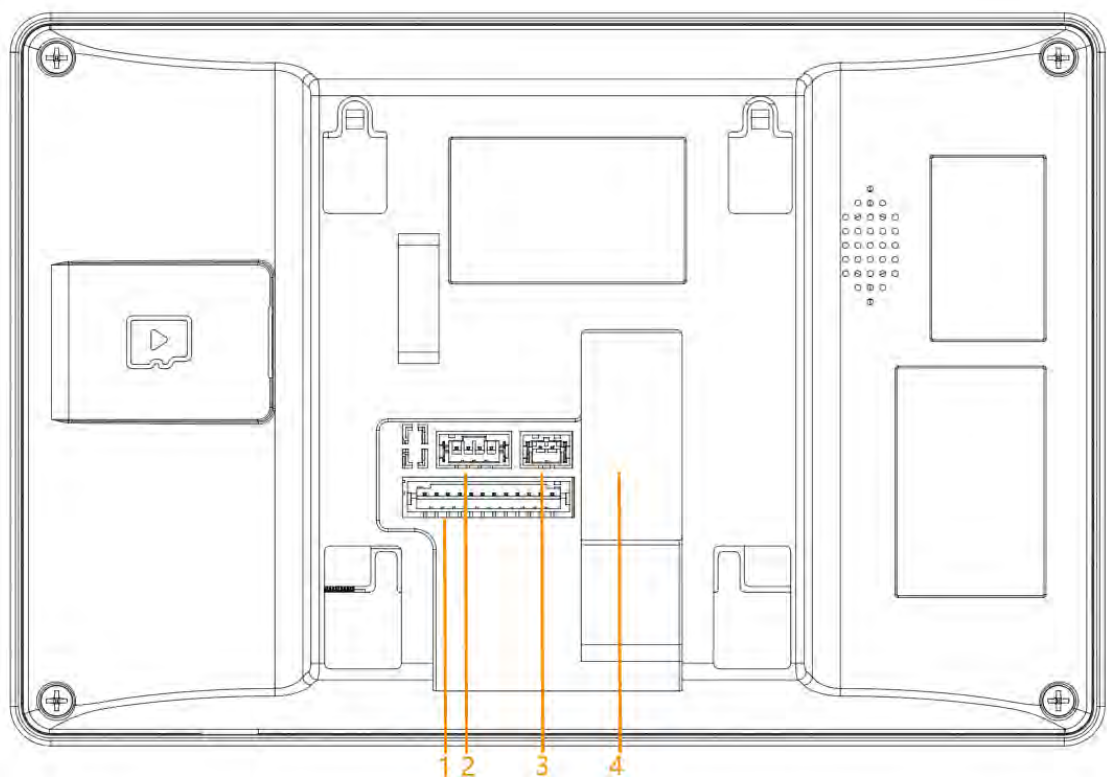
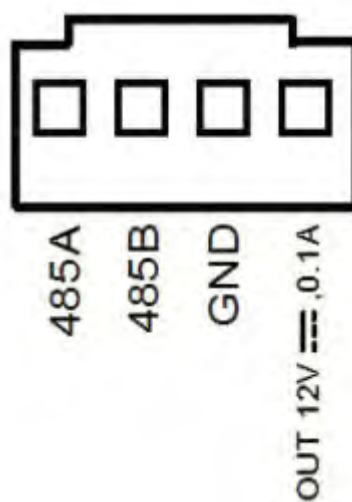

Table 1-12 Rear panel description

No.	Port
1	Alarm port
2	RS-485 and power output port
3	<ul style="list-style-type: none">• 5421H: Power input port• 5422H: 2-wire port
4	Network port

Figure 1-24 RS-485 port



1.2.10 VTH5441G Series

Figure 1-25 Rear panel

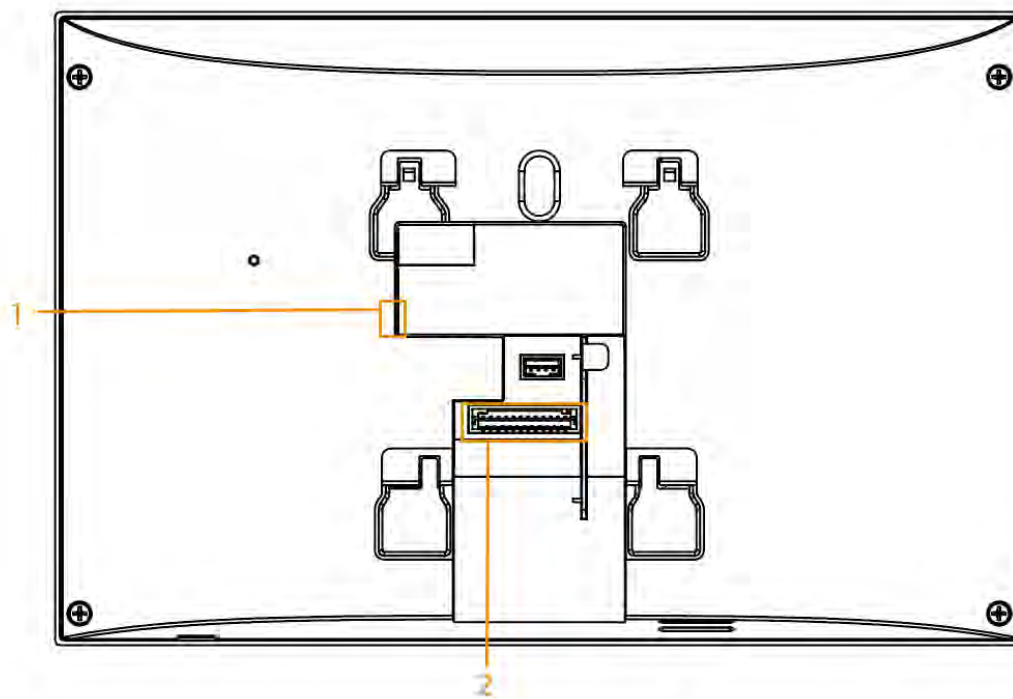

Table 1-13 Rear panel description

No.	Port
1	Network port
2	Alarm port

1.2.11 VTH8621K/VTH8622K Series

Figure 1-26 Rear panel

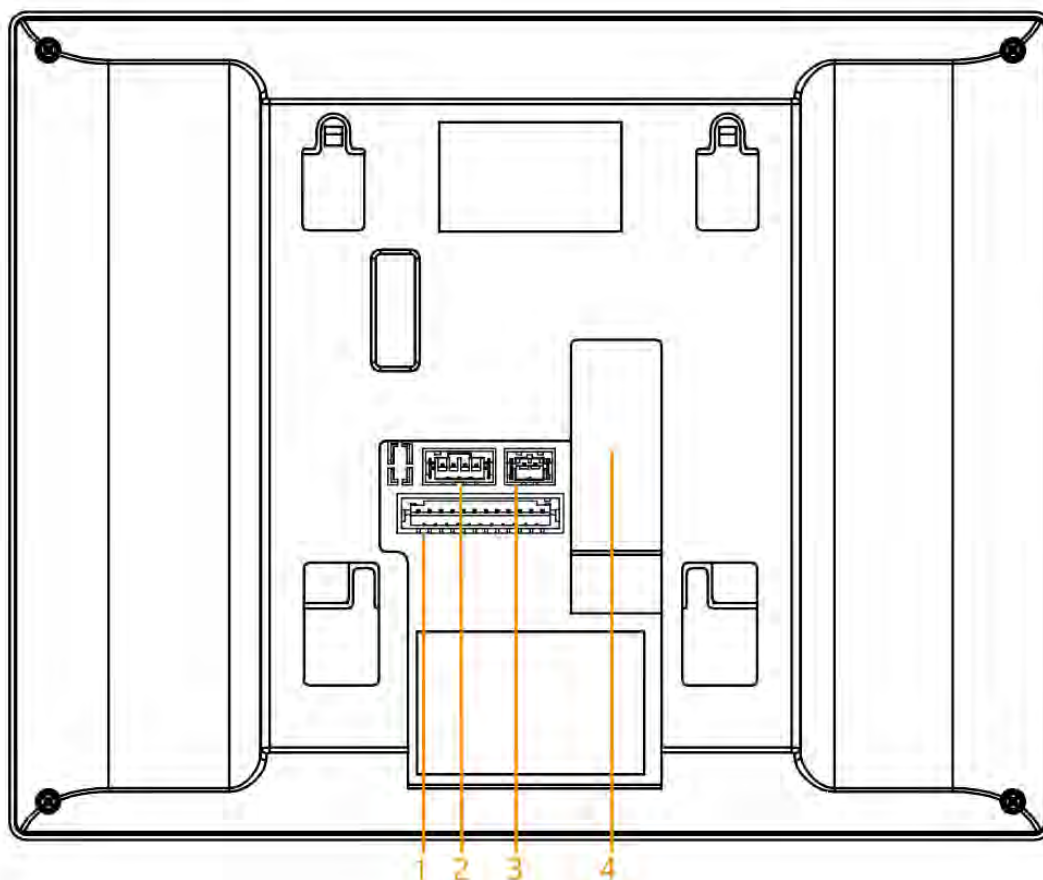

Table 1-14 Rear panel description

No.	Port
1	Alarm port
2	RS-485 and power output port
3	<ul style="list-style-type: none">• 8621K: Power input port• 8622K: 2-wire port
4	Network port

1.2.12 VTH8641K/VTH8642K Series

Figure 1-27 Rear panel

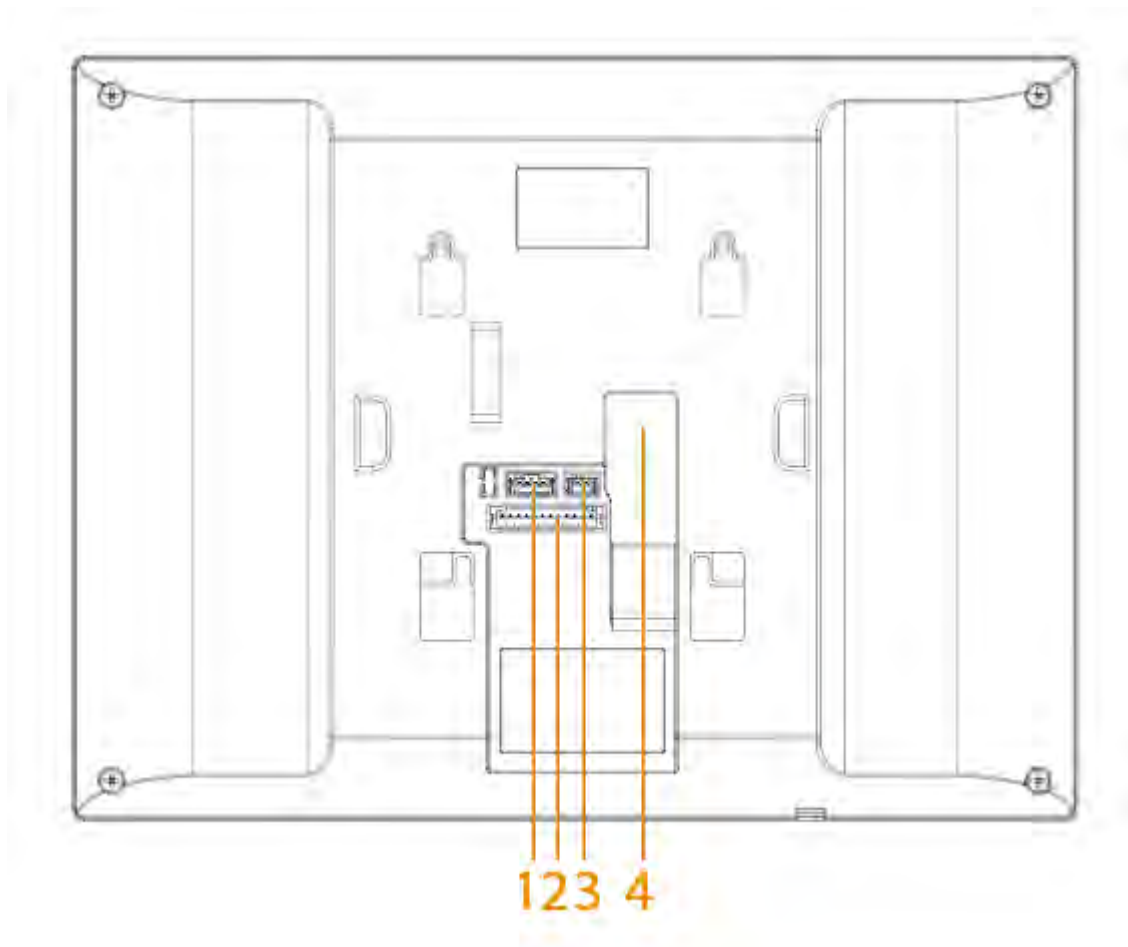
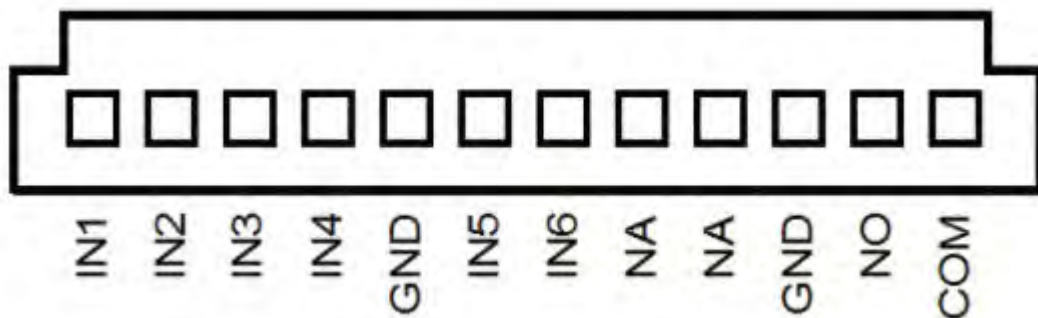

Table 1-15 Rear panel description

No.	Port
1	RS-485 and power output port
2	Alarm port
3	<ul style="list-style-type: none">● 8641K: Power input port● 8642K: 2-wire port
4	Network port

1.3 Alarm Port

Figure 1-28 Alarm port



1.4 Function

Wi-Fi Networking

Connect to Wi-Fi networks.



The Wi-Fi function is available on select models.

Video/Voice Call

Make video or voice call to other VTOs and VTHs.

Monitoring

Monitor fence station, VTO and IPC devices (only supported by certain models).

Concierge

Make calls to the Management Center.

Auto Snapshot

Take snapshots when calling or monitoring, and store them in the SD card.



The SD card is available on select models.

DND (Do Not Disturb)

Mute all message and call notifications.

Remote Unlock

Unlock doors remotely.

Arm and Disarm

Arm and disarm up to 8 alarm devices.

Playback

Play back videos and pictures in the SD card.



The SD card is available on select models.

Alarm

Alarms will trigger linkage and be sent to the Call Center.

Record

View call and alarm records.

Message

View picture messages and announcements.

2 VTH Initialization

2.1 Initialization through the Device

This manual uses the snapshots from 7-inch device as the example. The interfaces on 4.3-inch device is the similar with that on 7-inch device.



The snapshots are for reference only.

Procedure

Step 1 Select a region, and then tap **Next**.

Figure 2-1 Region

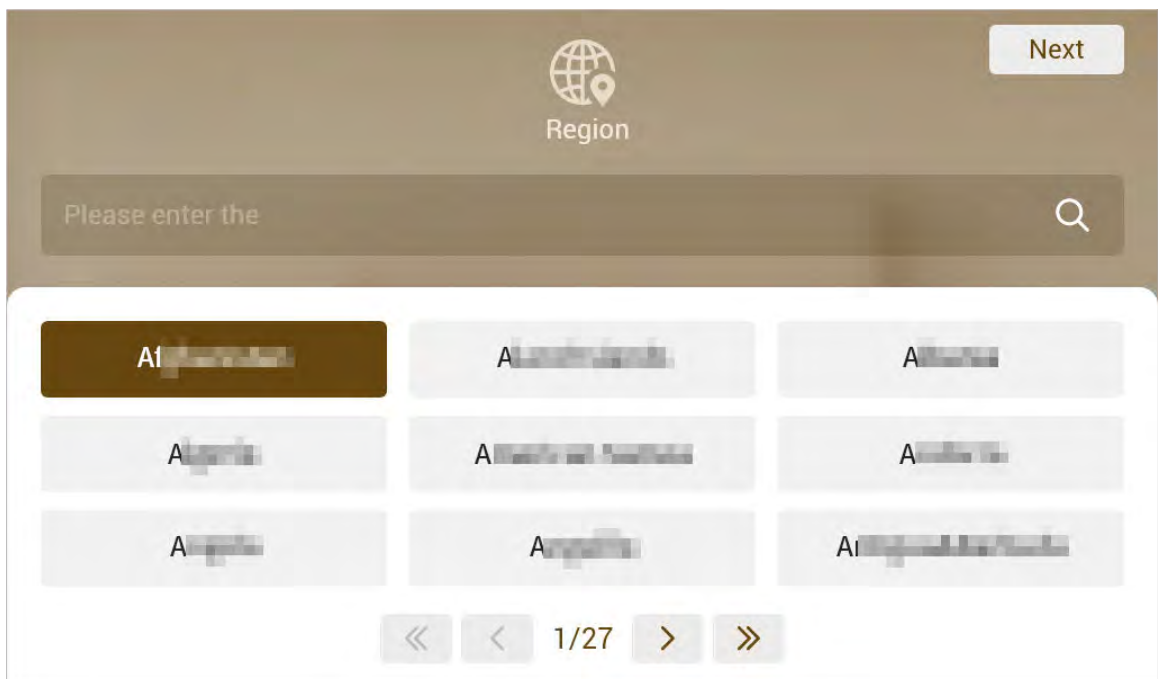

Step 2 Select a language, and then tap **Next**.

Figure 2-2 Language



Step 3 Select **Apartment** or **Villa**, and then tap **Next**.

This section takes **Villa** as an example.

Figure 2-3 Scene

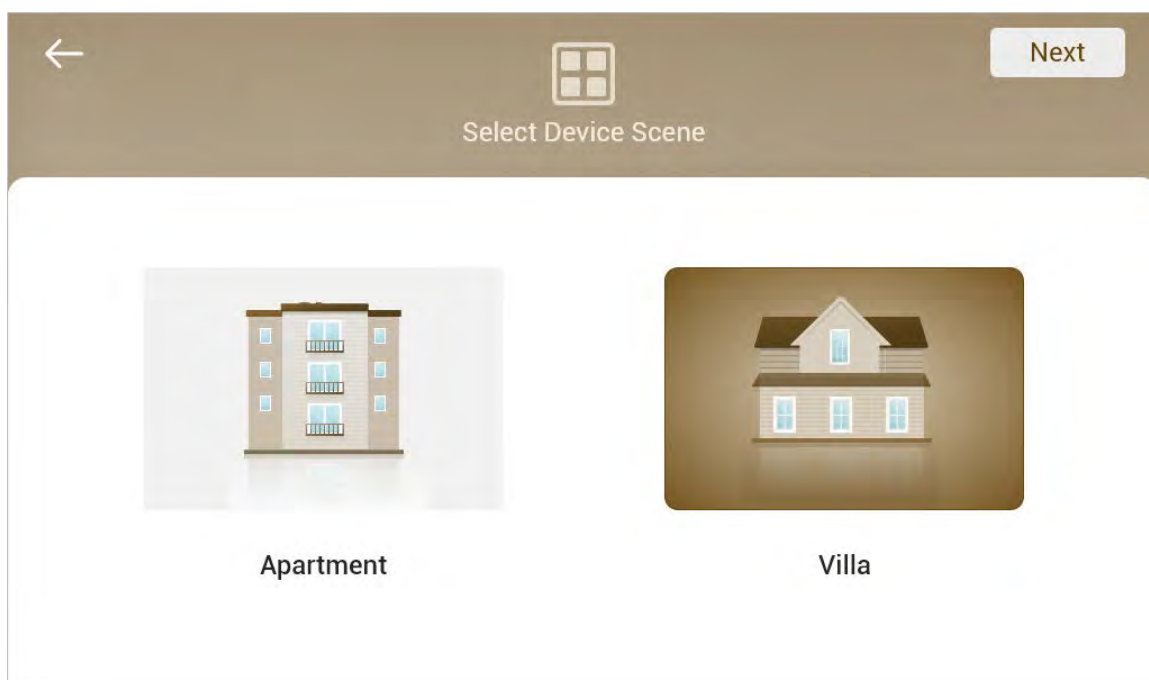

Step 4 Select **First-time Config**, and tap **Next**.

Figure 2-4 First-time configuration

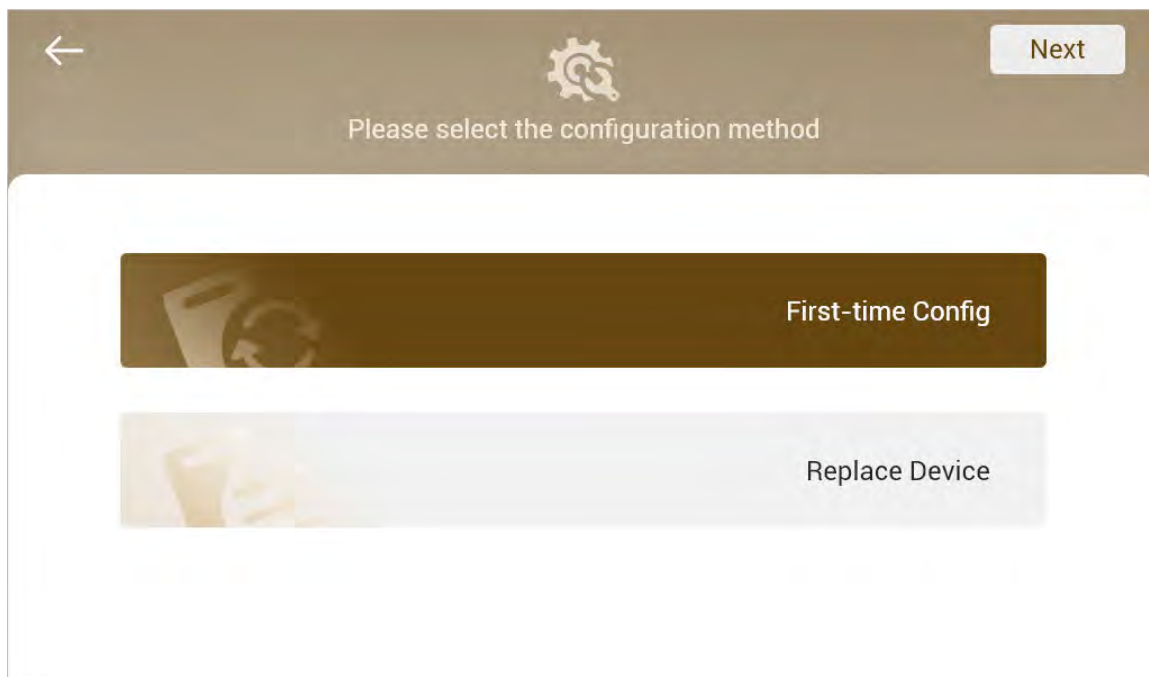

Step 5 Configure the network parameters, and then tap **Next**.

You can also enable **DHCP** , and then tap **Next**.

Figure 2-5 IP settings



Step 6 Set a password for the VTH, and then tap **Next**.

You can select the **Email**, and then enter the email address for resetting the password.



- The password is used to enter project setting.
- If you select **Apartment** in Step 2, initialization is completed with this step.

Figure 2-6 Password setting

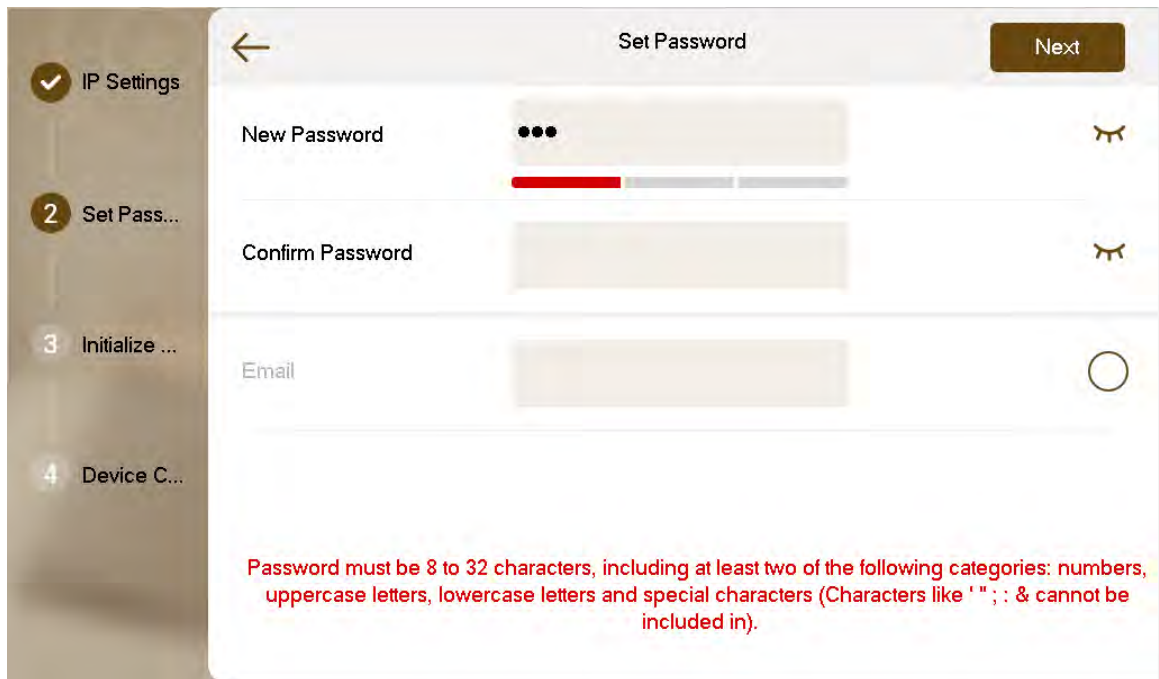

Step 7 Tap **Uninitialized** to initialize a single device, and then tap **Next**.

Initialize All : If there are many devices, tap to initialize all devices that are displayed in the list.

Step 8 After initialization, tap **Edit** to configure the detailed information of the device.





- The device you are using cannot be edited.
-  : Indicates that the device is the main device.
-  : Indicates that the device is the sub device.

Figure 2-7 Edit the device information



Step 9 Configure the parameters, and then tap **OK**.

- Configure the network parameters if you want to configure the VTH.

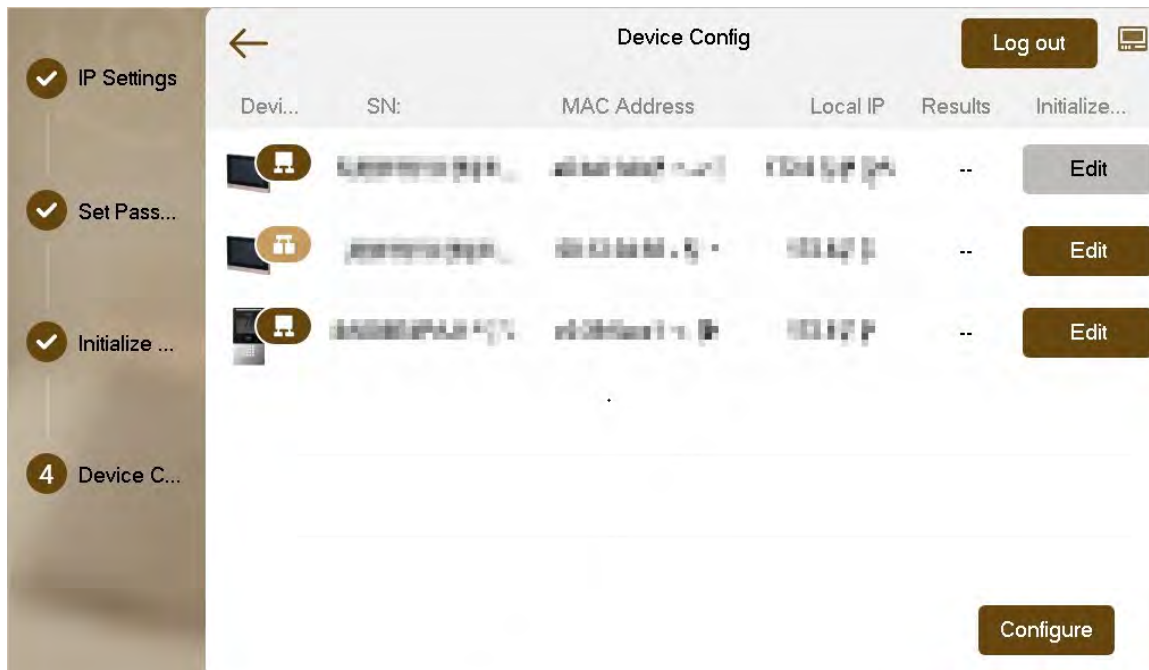
Figure 2-8 Configure the VTH

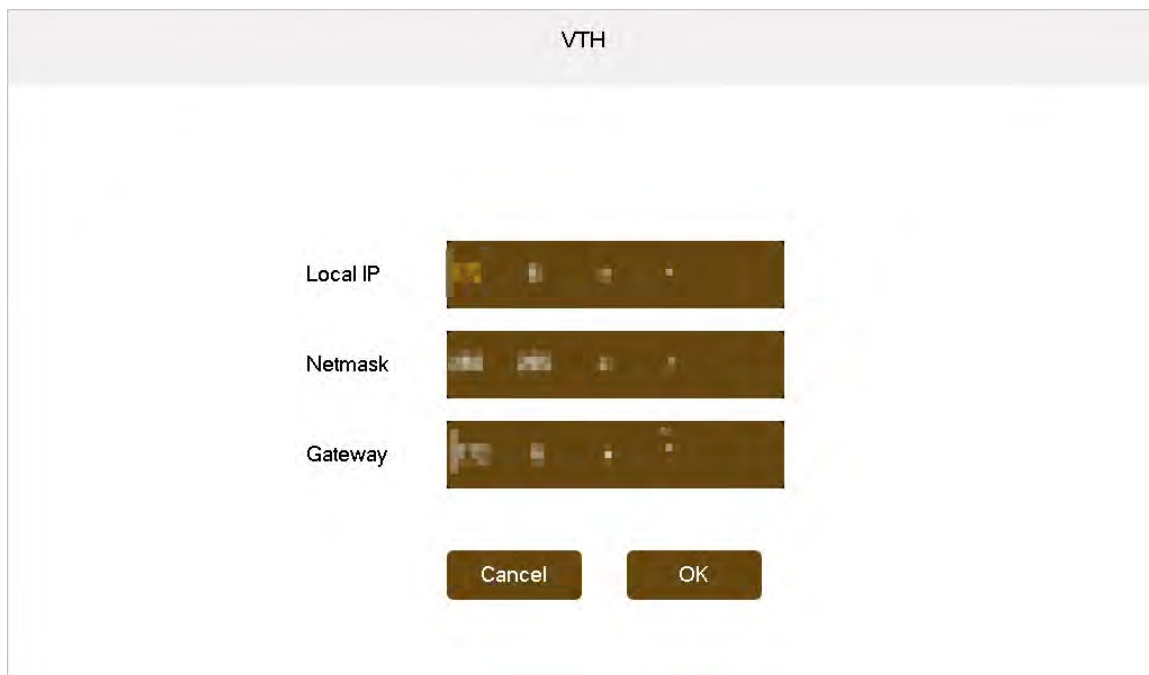

- Configure the network parameters if you want to configure the sub VTO.

Figure 2-9 Configure the sub VTO

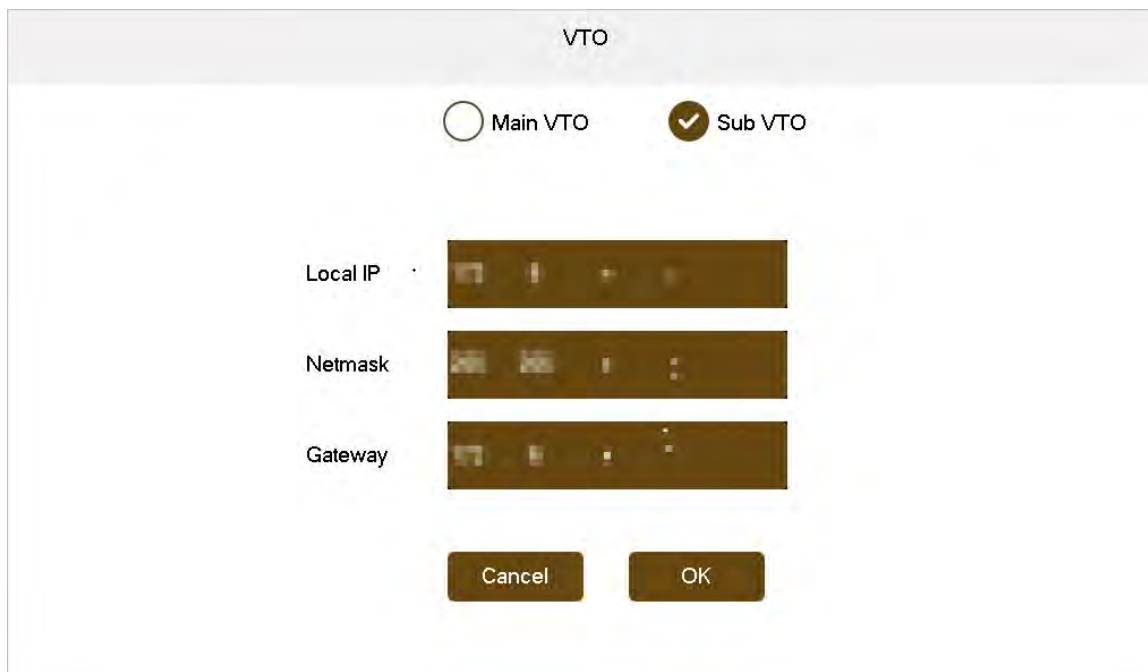

- Configure the network parameters and the time if you want to configure the main VTO.

Figure 2-10 Configure the main VTO



Step 10 Tap **Configure** to finish the initialization.

- **Log out** : Tap to directly go to the home screen. If you edit the parameters, and tap **Log out**, the configurations for the device are invalid.
- **Modify** : Tap to modify the device configurations.

Figure 2-11 Configure the device

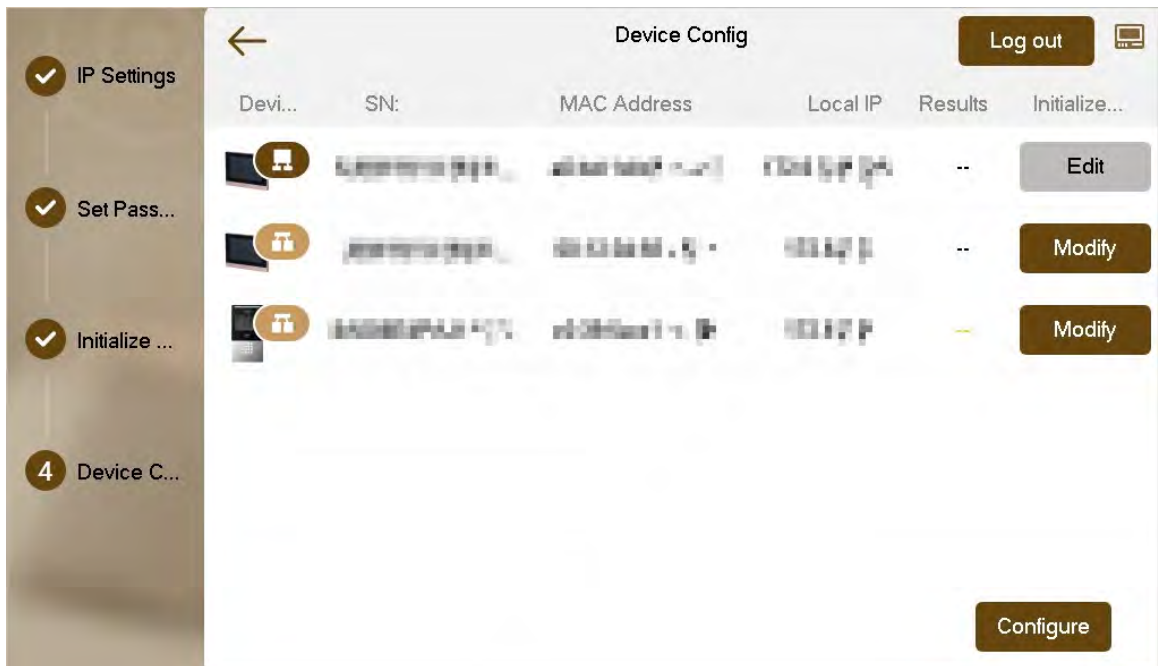

2.2 Initialization through the ConfigTool

You can initialize the VTH, and configure the building parameters through the ConfigTool. For details, see the ConfigTool user's manual.

3 VTH Screen Operation

3.1 Home Screen

Figure 3-1 Home screen

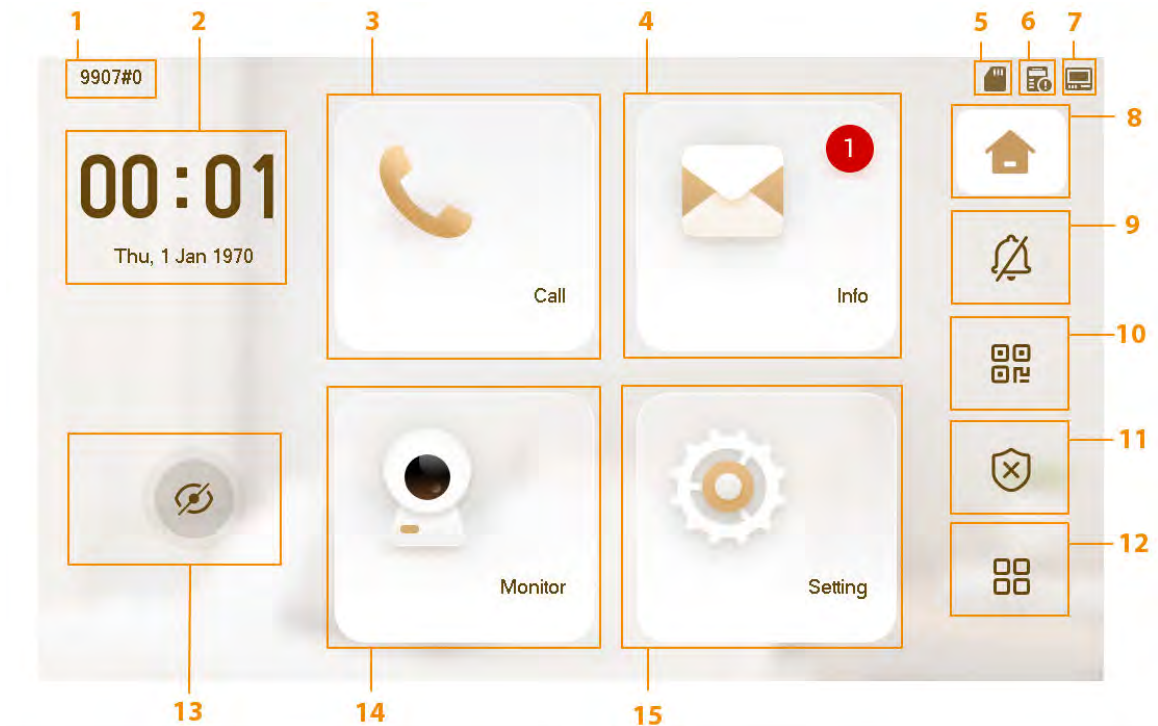











Table 3-1 Home screen description

No.	Name/Icon	Description
1	Room number	Number of the room where the VTH is located.
2	Time and Date	Displays the time and date.
3	Call	<ul style="list-style-type: none"> ● Call other VTOs and VTHs. ● View and manage the contacts and call records. ● Call the DMSS app.
4	Info	<ul style="list-style-type: none"> ● View, delete and clear announcements or security alarm information. ● When the VTH does not have an SD card, and the video-audio message uploading function is enabled on the VTO, you can view, delete and clear the messages. ● When the VTH has an SD card, you can view, delete and clear the videos and pictures.

No.	Name/Icon	Description
5		Displays the SD card status.  The SD card is available on select models.
6		Failed to connect to the SIP server.
7		Connected to the network through a cable.
8		Tap to view the home screen. You can call, monitor, view the information and enter the setting screen.
9		DND. Enable to not receive calls or messages.
10		The QR code for downloading the DSS app, registering for the DSS app and scanning the DMSS QR code to remotely manage the device.
11		Scene. Tap to select one of the following arming modes: Sleep, Away, Home or Custom .
12		<ul style="list-style-type: none"> View the other main functions, including restarting the system and calling the Management Center. Edit the home screen. For details, see "3.2 Editing Home Screen".
13		Tap to turn off the current screen.
14	Monitor	Monitor VTOs, fence stations, IPCs and NVRs.
15	Setting	Enter setting page to configure the call, alarm, scenes, general parameters and view the system information.

3.2 Editing Home Screen

Edit the home screen to display the functions as needed.

Procedure

Step 1 Tap  to view other functions, and then tap **Edit Home Screen**.





- : Call the management center.
- : Restart the VTH.

Figure 3-2 Other functions



Step 2 Select the functions that you want to be displayed on the home screen, and then tap  to save the configuration.

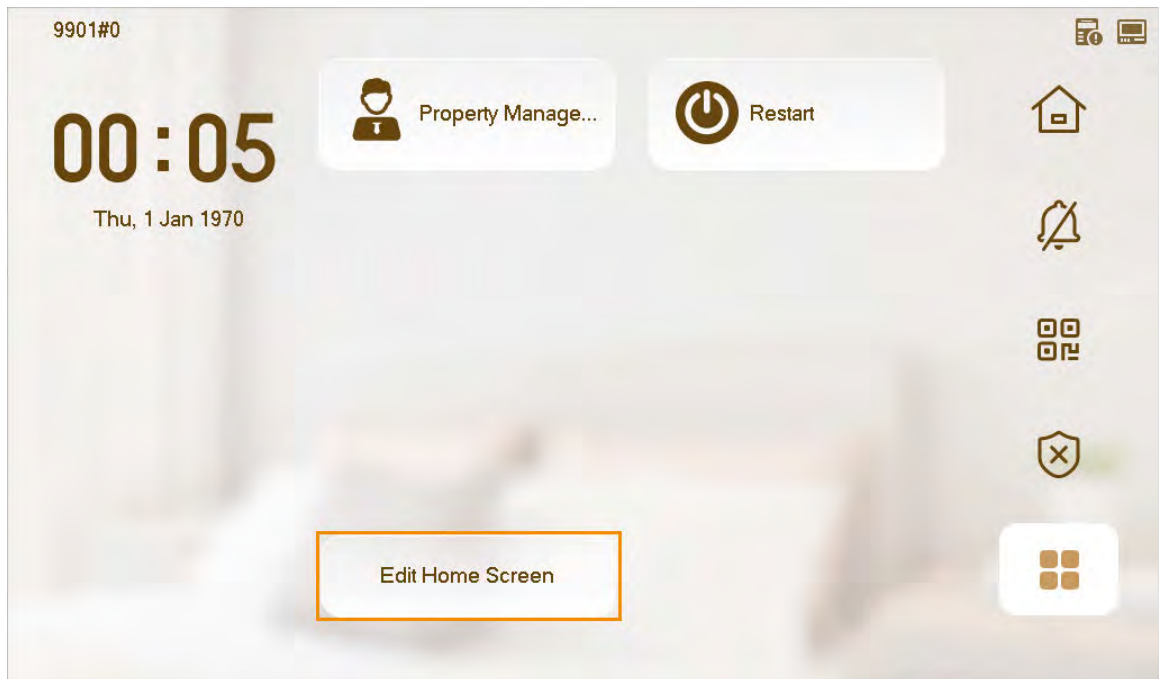

 and  are displayed by default. 3 functions can be displayed or modified on the home screen.

Figure 3-3 Home screen functions

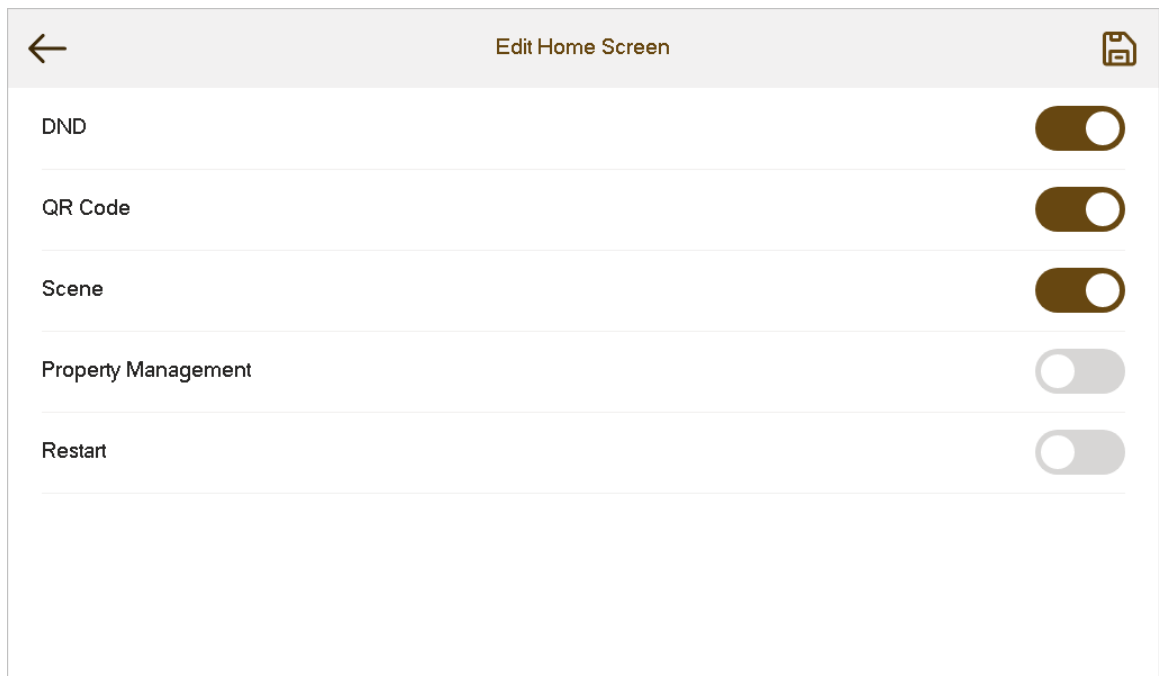

3.3 Call

Manage contact, call and view call records.

3.3.1 Call Log





Tap **Call** >  to view and manage call records.

Figure 3-4 Call log

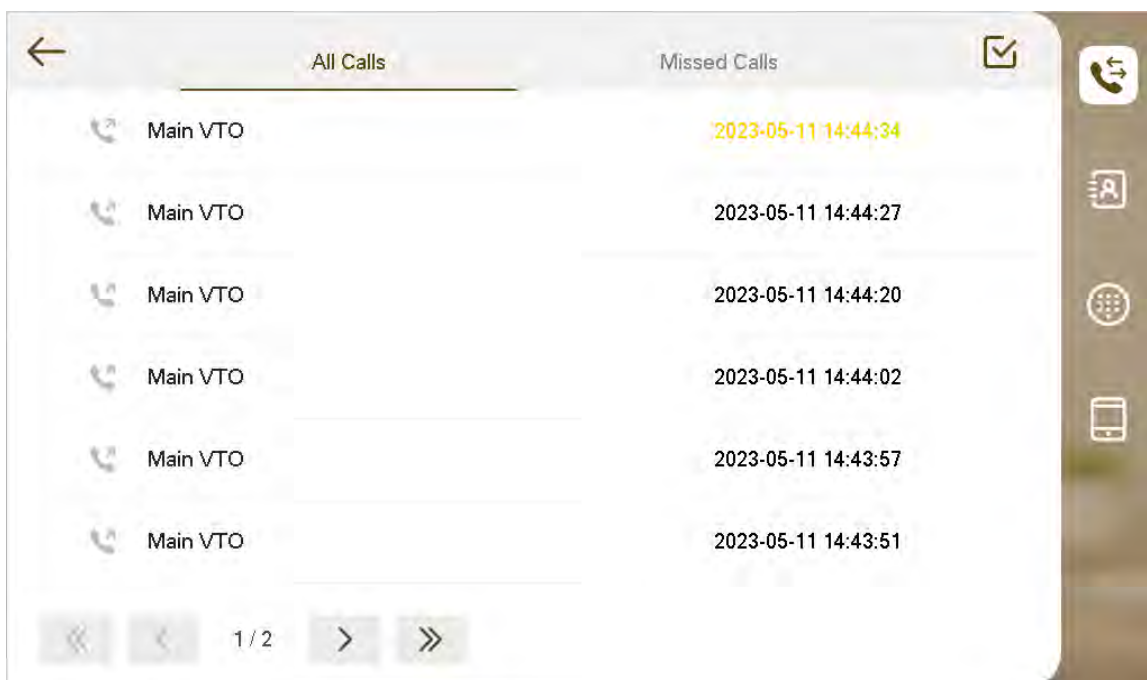

- **Call back** : Tap a call record to call back.
- **Delete** : Tap , select the record, and then tap  to delete a record.
- **Clear** : Tap  to clear all record in the current tab (**All** or **Missed Call**).

If storage is full, the oldest records will be overwritten. Back up the records as needed.

3.3.2 Contacts

Viewing Contacts

Select **Call** > , and then add or edit the users.

Figure 3-5 Contacts



Adding the User

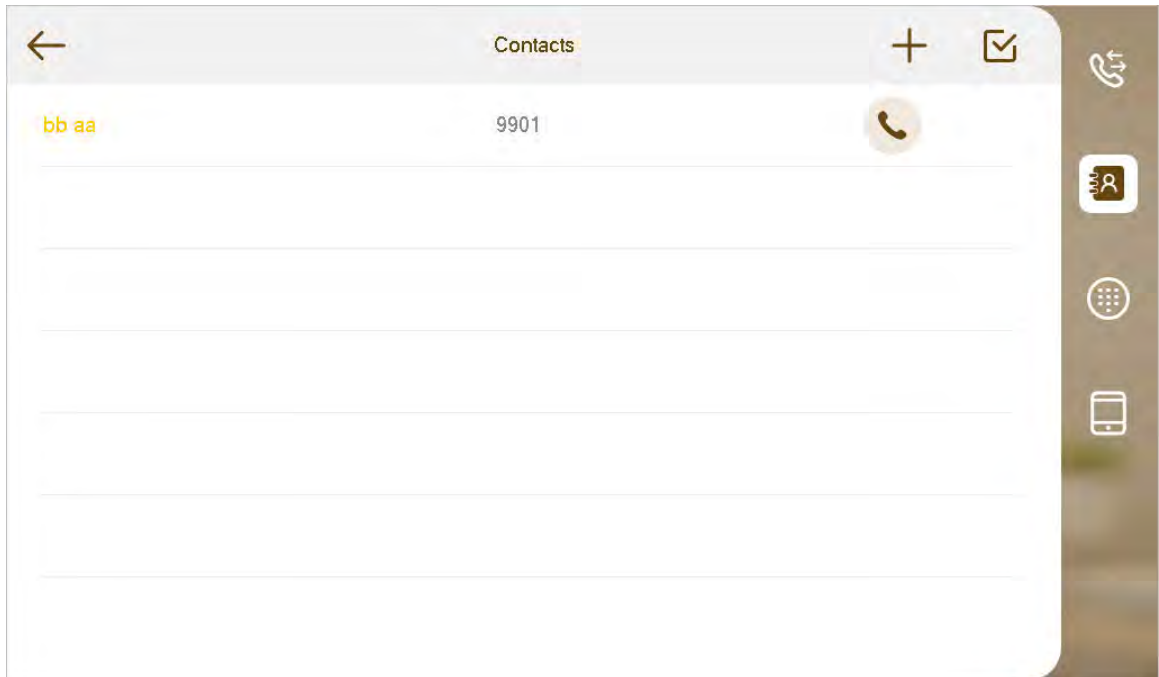

1. Tap +.

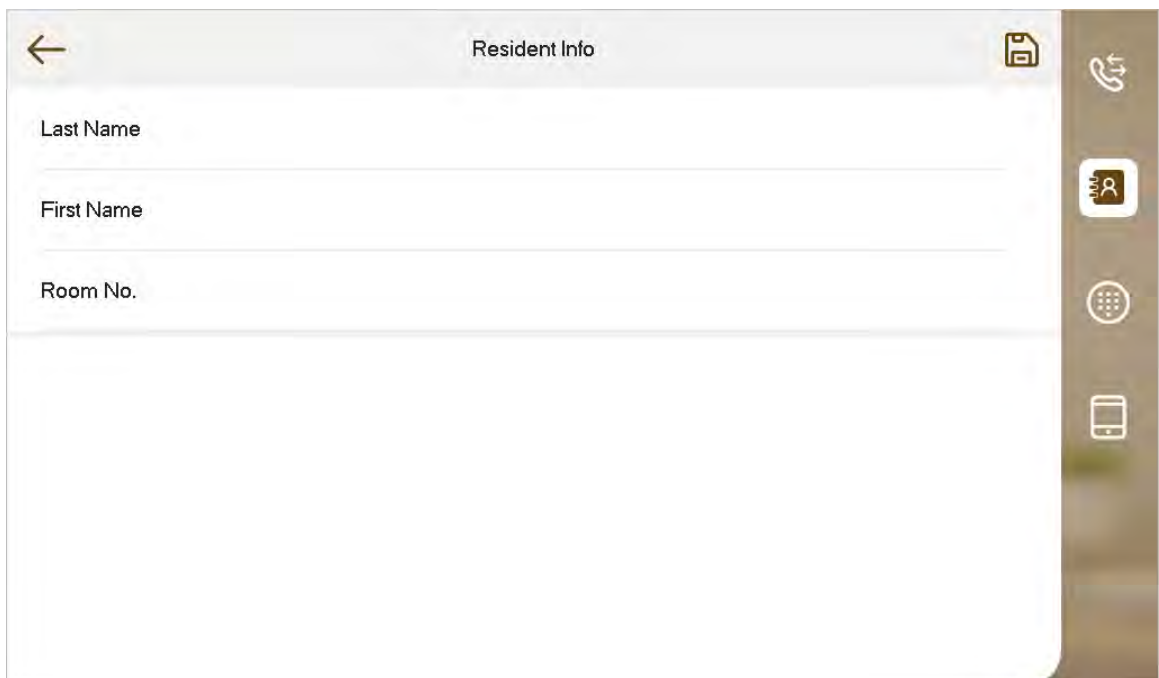
Figure 3-6 User information



2. Enter the information.
3. Tap .

Related Operations

- Edit user information:
 - Tap a user, modify the information, and then tap .
- Delete the user:
 - ◊ Tap a user, and then tap **Delete**.
 - ◊ Tap , select a user, and then tap .

You can select multiple contacts to delete at the same time.

3.3.3 Calling User

- Make sure that resident-to-resident call function has been enabled.
- Call function is used by VTH to call VTH, VTO, VTS and the platform.
- If both VTHs have a camera, bilateral video call can be provided.

3.3.3.1 By Room Number

On the **Dial Pad** screen, dial and call the user.

Procedure

Step 1 Select **Call** > .

Figure 3-7 Call

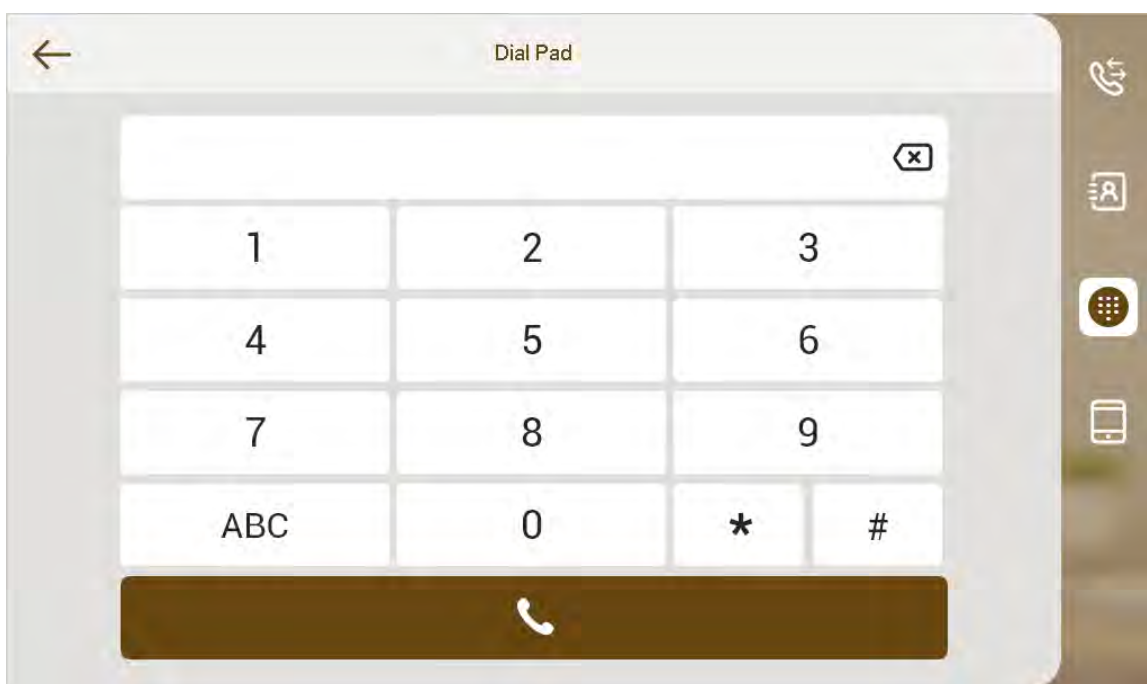

- Step 2 Enter the room number (VTH room number).
- If VTO works as SIP server, dial room number directly.
 - If the platform works as SIP server:

- ◇ Call a user in the same unit and the same building, dial room number directly.
- ◇ Call a user in other buildings or units, add the building number. For example, dial 1#1#101 to call Building 1 Unit 1 Room 101.



If main VTH (101#0) calls extension (101#1), please enter room no.: #1; if the extension calls main VTH, please enter room number.: #0.

Step 3

Tap .



If the VTH has a camera, there will be videos after answering the call.

Figure 3-8 Call not answered

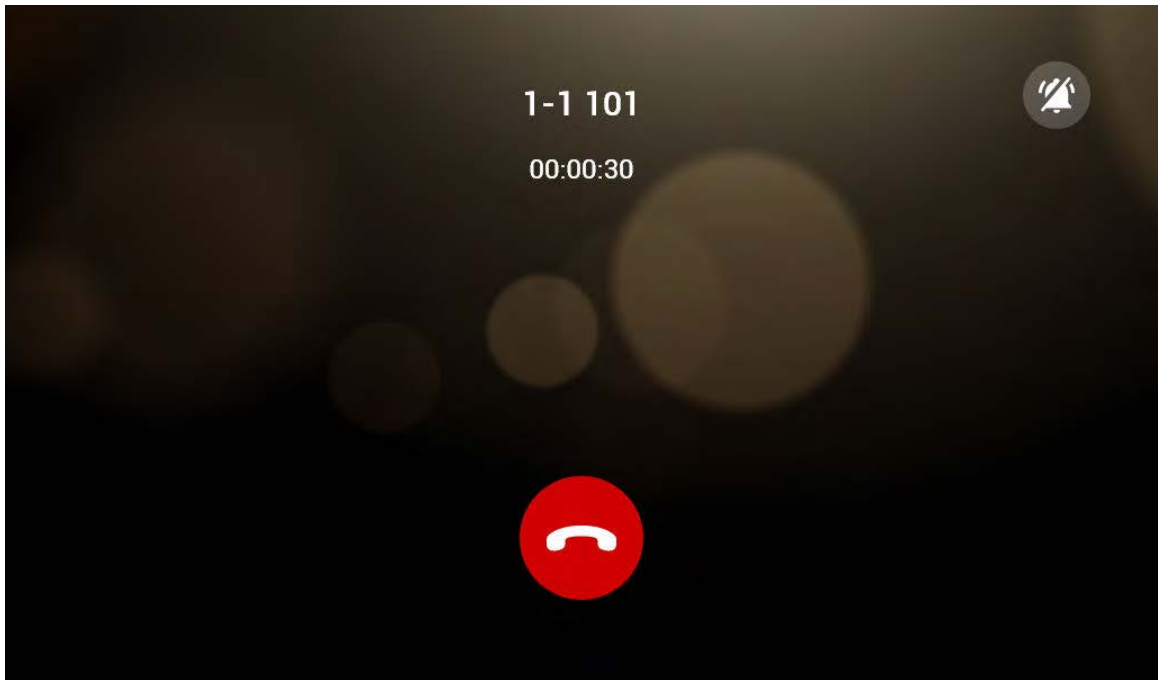
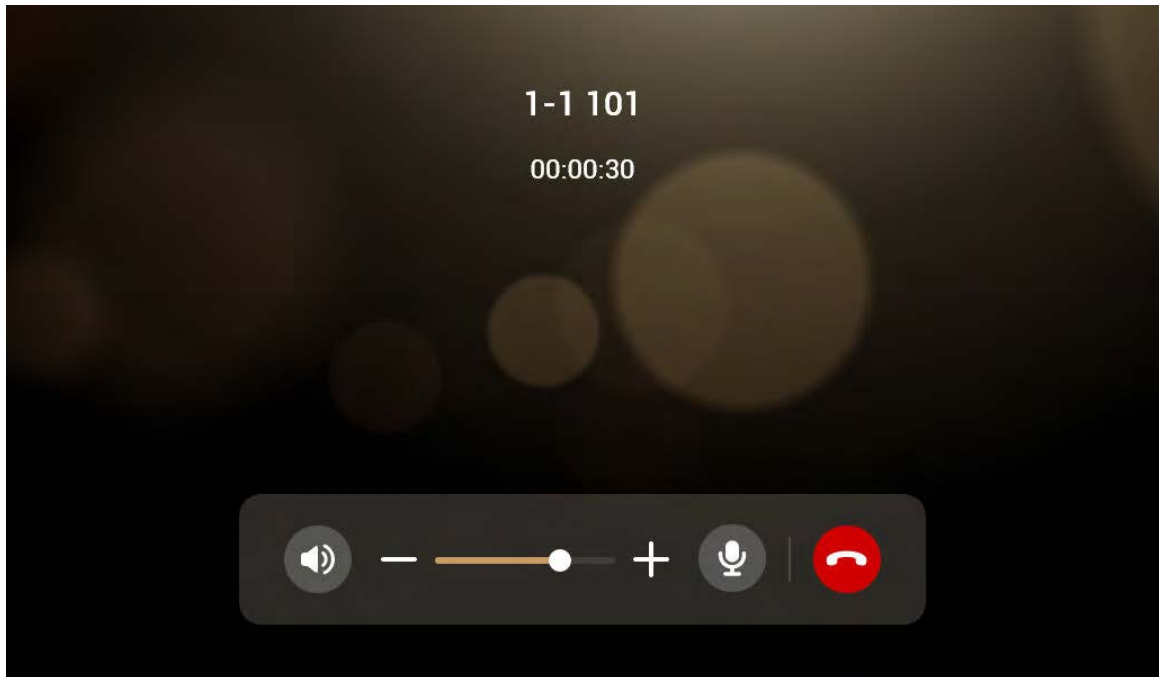



Figure 3-9 Call answered



3.3.3.2 From Contact

Procedure

Step 1 Select **Call** > .



Step 2 Tap  next to the user to call.

3.3.4 Call from User

When receiving calls from other VTHs, the following interface will be displayed.

Figure 3-10 Call screen



- : Answer.
- : Hang up.
- : Mute the voice.

3.3.5 Call from VTO

Procedure

- Step 1 Dial VTH room number (such as 9901) at VTO, to call VTH.
- Step 2 On the VTH screen, tap **Answer**.



If the network connection is bad, the device will adjust the video stream according to the actual situation.

Figure 3-11 Call from VTO

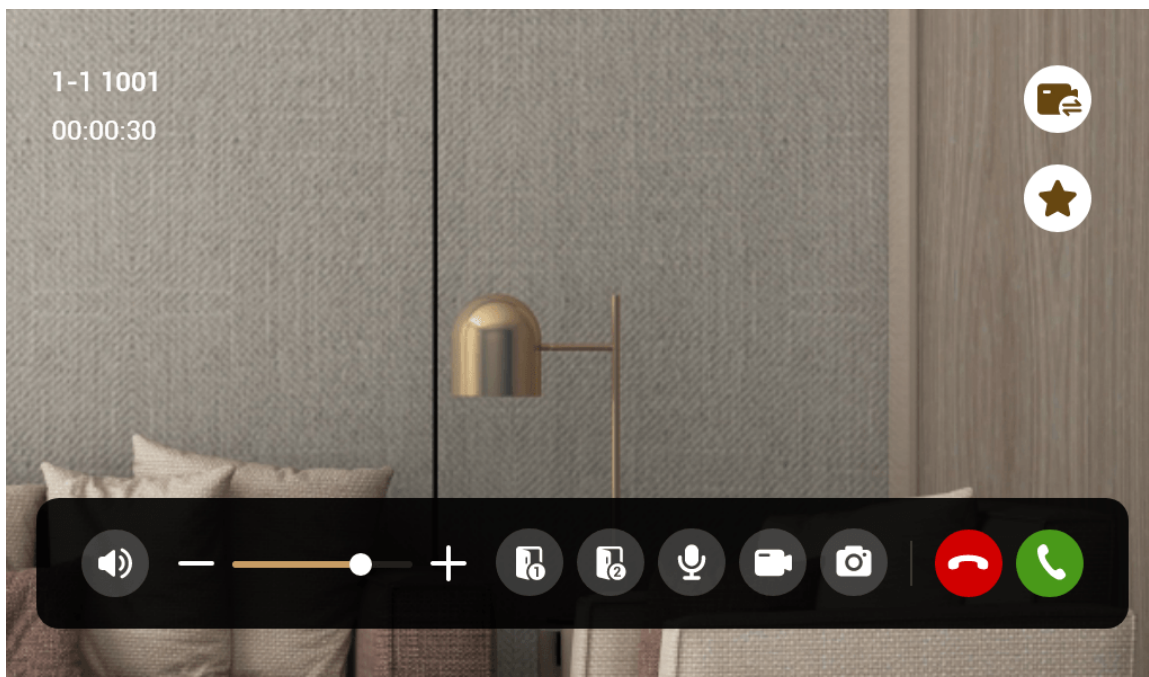





Table 3-2 Call screen description

Key	Description
	<p>Remotely unlock the door where the VTO is installed.</p> <p></p> <p>The system provides 2-channel unlock. If the icon is gray, it means that the unlock function of this channel is not available.</p>
	<p>The microphone can be used. Tap the icon, and the microphone cannot be used.</p>
	<p>Tap to switch the IPC that is linked.</p>
	<p>Select an IPC in Favorite to monitor.</p>
	<p>Take snapshot.</p> <p></p> <ul style="list-style-type: none"> • This key will be gray if SD card is not inserted. • The SD card is available on select models.

Key	Description
	<p>Take recording. Complete recording when the call is completed or by tapping the stop icon.</p> <p></p> <ul style="list-style-type: none"> • This key is gray if SD card is not installed. • Videos are stored in SD card of this VTH. If SD card is full, the earlier videos will be covered. • The SD card is available on select models.
-	Reduce volume.
+	Increase volume.
	Answer calls.
	Hang up.

3.3.6 Calling DMSS

Select **Call** >  to make calls to DMSS.

Figure 3-12 DMSS



Tap **Tap to Call** to call the DMSS app account that the VTH has bonded with.

Figure 3-13 Call DMSS

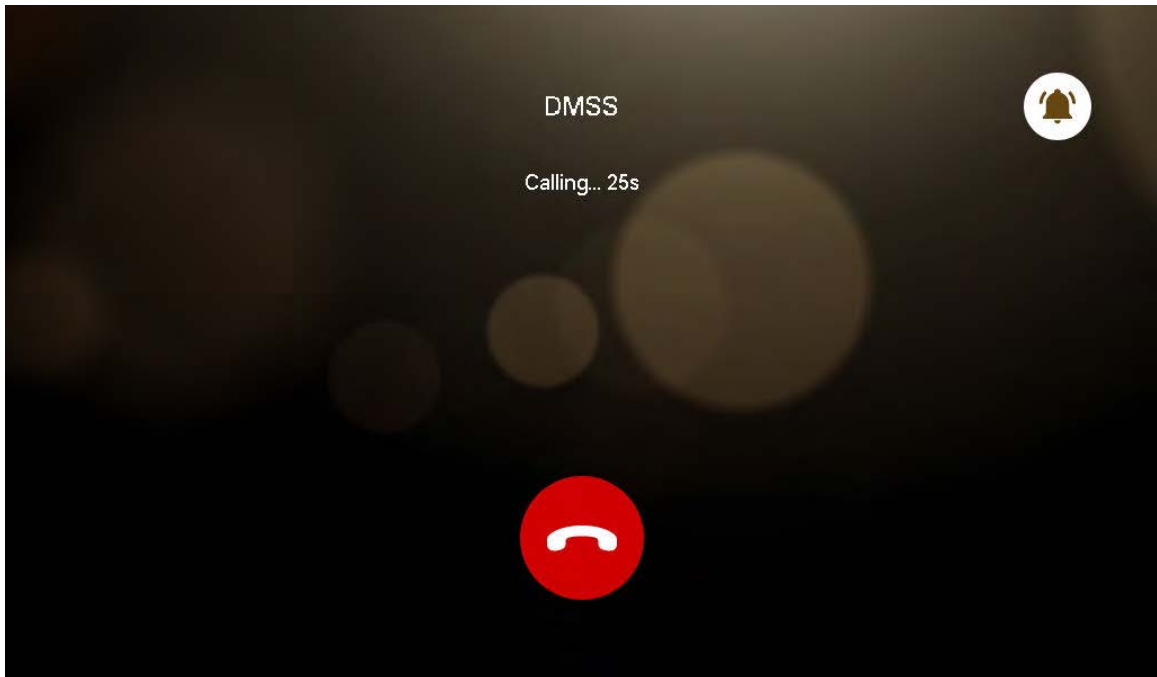

3.4 Information

You can view and manage different kinds of information.



- Information in **Security Alarm** and **Publish Info** is stored in the device, and the one in **Guest Message** and **Video Pictures** is stored in the SD card, which means you need an SD card for these two functions.
- Only certain models support SD card.
- If the storage in the Device or SD card is full, the oldest records will be overwritten. Back up the records as needed.

3.4.1 Security Alarm

When an alarm is triggered, there will be 15s alarm sound, and the interface below will be displayed. The alarm information will be uploaded to the alarm record interface and management platform.

Select **Info** > , and then you can view and manage all alarm records.

Figure 3-14 Security alarm



3.4.2 Publish Information

Select **Info** > , and then you can view and manage all messages.

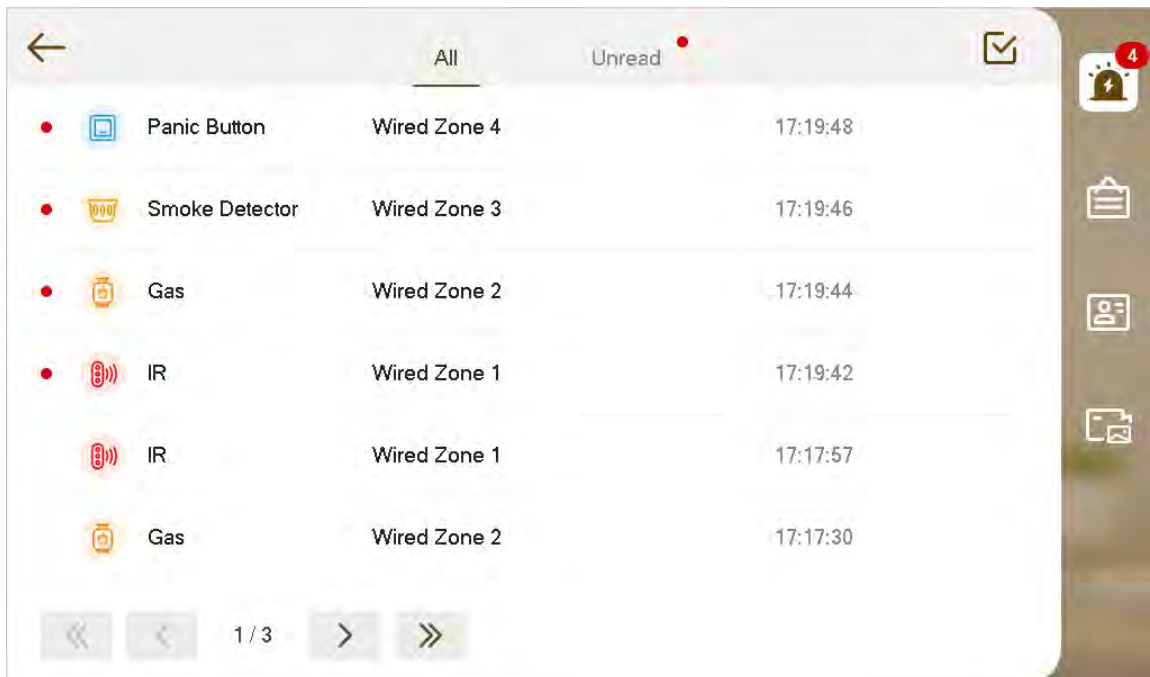
Figure 3-15 Publish information



3.4.3 Guest Message

Select **Info** > , and then you can view and manage all messages.

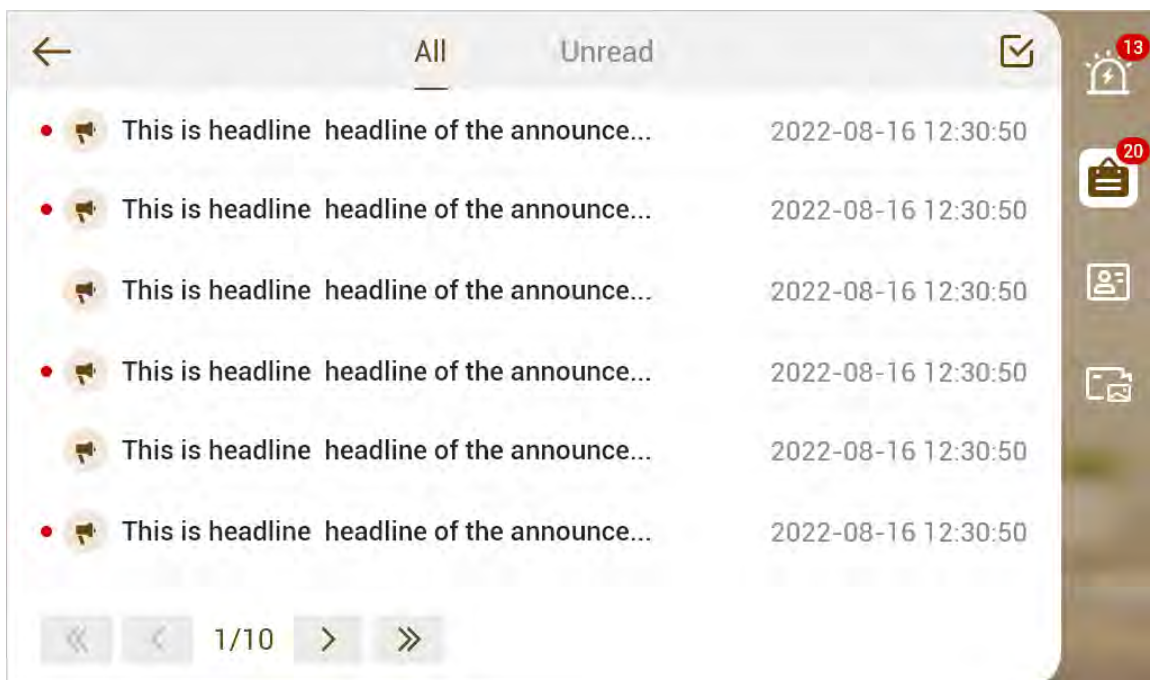
Figure 3-16 Guest message



3.4.4 Video Pictures

Select **Info** > , and then you can view and manage the pictures and videos.

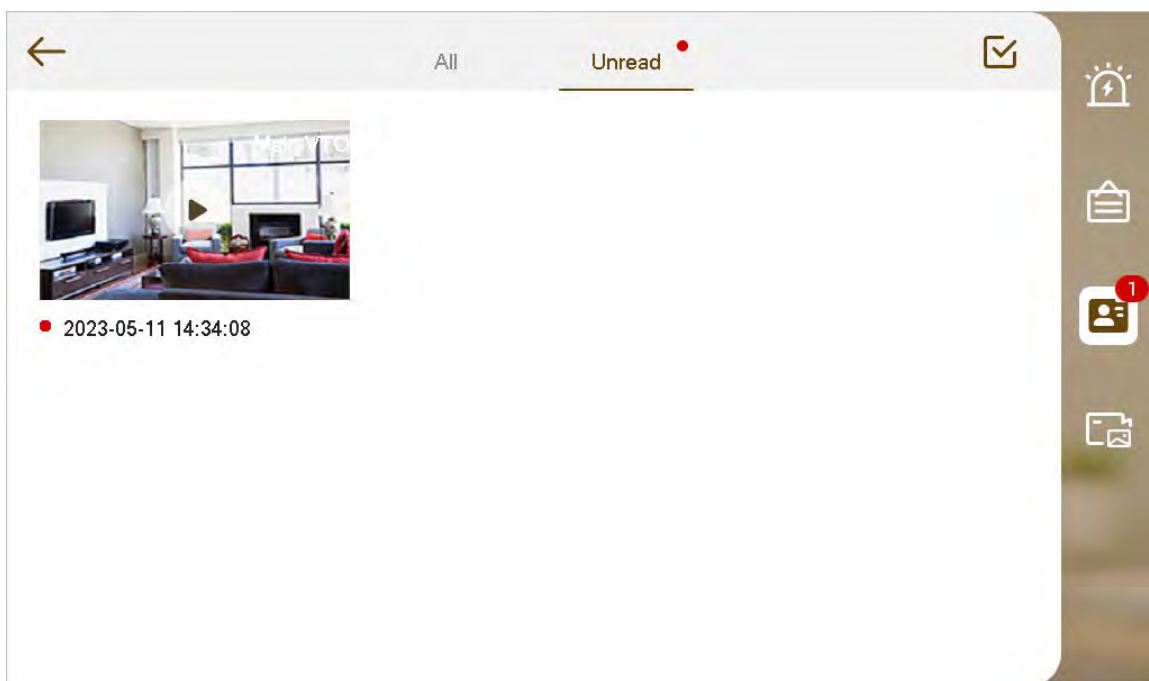
Figure 3-17 Records

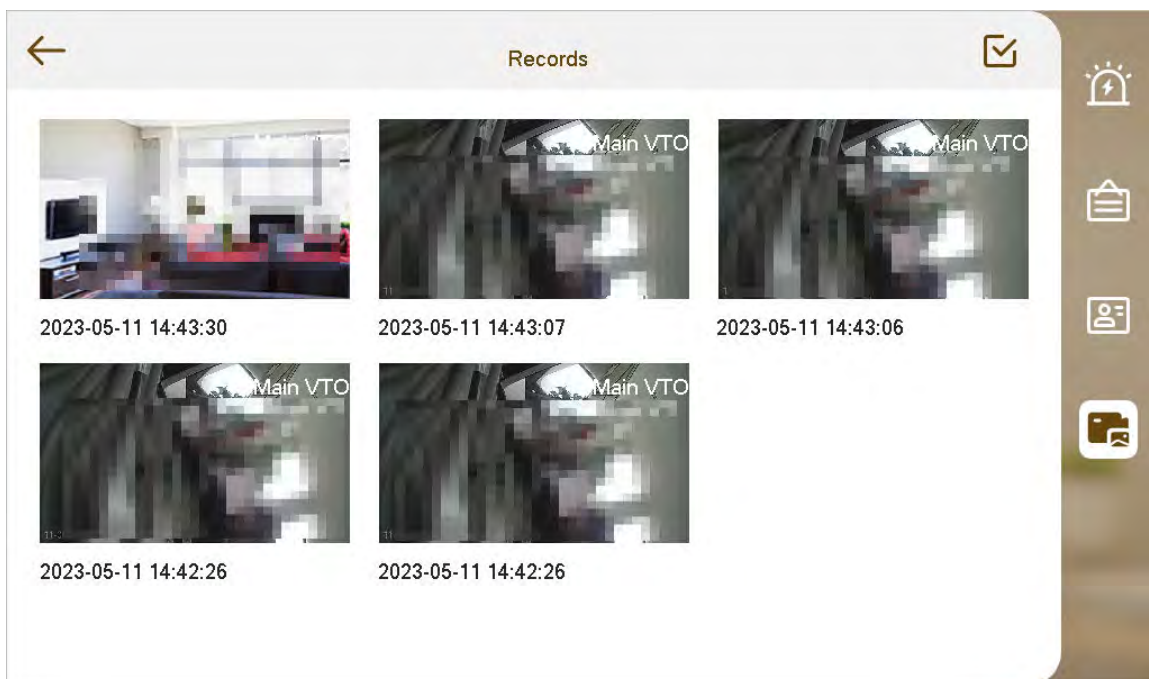

3.5 Monitor

You can monitor VTO, fence station or IPC on the VTH.

3.5.1 Monitoring VTO



When adding VTOs, make sure that the username and password of each device is consistent with the web login username and password. Otherwise, monitoring will not work properly.

Procedure

Step 1 Select **Monitor** > .

Figure 3-18 VTO list



: Add the VTO or fence station to **Favorites**.

Step 2 Tap .

Figure 3-19 Monitoring VTO

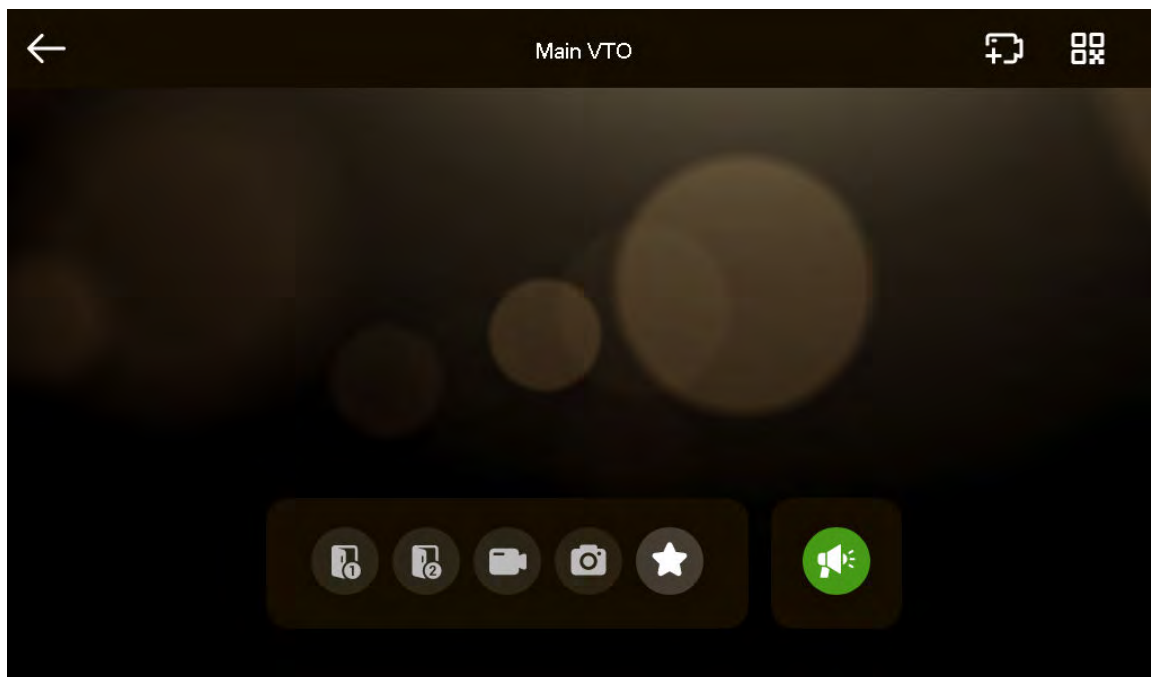

















Table 3-3 Interface description

Icon	Description
	<p>Remotely unlock the door where the VTO is located.</p> <p></p> <p>The system provides 2-channel unlock function. If the icon is gray, it means that unlock function of this channel is not available.</p>
	<p>Take snapshot.</p> <p></p> <ul style="list-style-type: none"> • An SD card is needed to use this function. • The SD card is available on select models.
	<p>Tap to start recording, and it will stop when the call is completed or by tapping the stop icon.</p> <p>If the SD card is full, the oldest videos will be overwritten.</p> <p></p> <ul style="list-style-type: none"> • An SD card is needed to use this function. • The SD card is available on select models.
	<p>The VTO has been added to Favorites.</p>

Icon	Description
	<p>If the VTH is connected to multiple VTOs/IPC, tap  and  to switch device.</p> <p></p> <p>If the VTH is connected to one VTO, the icon will not be displayed.</p>
	Exit monitoring.
	Tap to speak to the other end device.
	Select an IPC, and when this VTO or fence station calls, you will see the monitoring image from this IPC.
	Display the serial number of the VTO or fence station in QR code. Scan the QR code in the app to add it to the app, and then you can monitor the VTO from your smart phone.

3.5.2 Monitoring IPC

3.5.2.1 Adding IPC

Background Information

- IPCs added to the main VTO will be synchronized to the VTH. The synchronized IPCs cannot be deleted.
- Before adding an IPC, make sure that it is powered on, and connected to the same network as the VTH.

Procedure

Step 1 Select **Monitor** > .

Figure 3-20 IPC

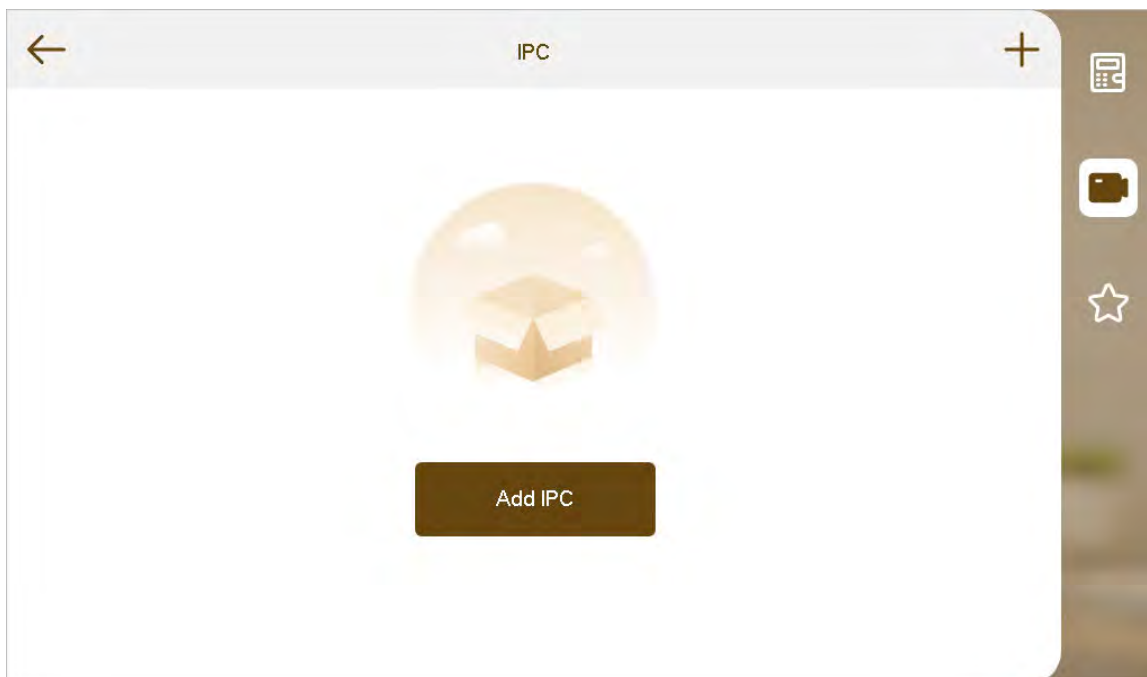

Step 2 Tap **Add IPC** or +.

Figure 3-21 Add IPC



Step 3 Configure the parameters.

Table 3-4 Parameter description

Parameter	Description
Device Type	Select IPC or NVR.

Parameter		Description
Device Info	Channel	<ul style="list-style-type: none"> ● If IPC is connected, default setting is 1. ● If NVR is connected, set channel number of IPC on NVR.
	Device Name	Name of the IPC/NVR.
	Stream Type	<ul style="list-style-type: none"> ● Main stream: High definition that needs large amount of bandwidth. Applicable to local storage. ● Extra stream: Relatively smooth image that needs small amount of bandwidth. Applicable to network with insufficient bandwidth.
	Protocol	It includes local protocol and ONVIF protocol. Please select according to the protocol of the connected device.
	Encryption	Enable it if the IPC to be added is encrypted.
Network Config	IP	IP address of the IPC/NVR.
	Username	The login username of the webpage of the IPC/NVR.
	Password	The login password of the webpage of the IPC/NVR.
	Port	554 by default.
Favorites		Add the IPC to Favorites .

Step 4 Tap .



Related Operations

 : Add the IPC to **Favorites**.

3.5.2.2 Modifying IPC

Procedure

Step 1 Select **Monitor** > .

Step 2 Tap  of the IPC, and then tap  at the right upper corner.

Step 3 Modify IPC parameters.

For details, see Table 3-4 .

Step 4 Tap .



3.5.2.3 Deleting IPC



Delete the IPC that has been added. However, IPC synchronized from VTO or the platform cannot be deleted.

Procedure

Step 1 Select **Monitor** > .



Step 2 Delete the IPC.

- Tap  of the IPC, tap  at the right upper corner, and then tap **Delete IPC**.

- Tap , select the IPC, and then tap .



You can select more than one IPC to delete at the same time.

- Tap , and then tap  to clear all IPCs.



All the IPCs will be deleted in this way. Be careful.

3.5.2.4 Monitoring

Monitor the IPC.

Procedure

Step 1 Select **Monitor** > .

Step 2 Tap  to monitor the IPC.

Figure 3-22 Monitoring IPC

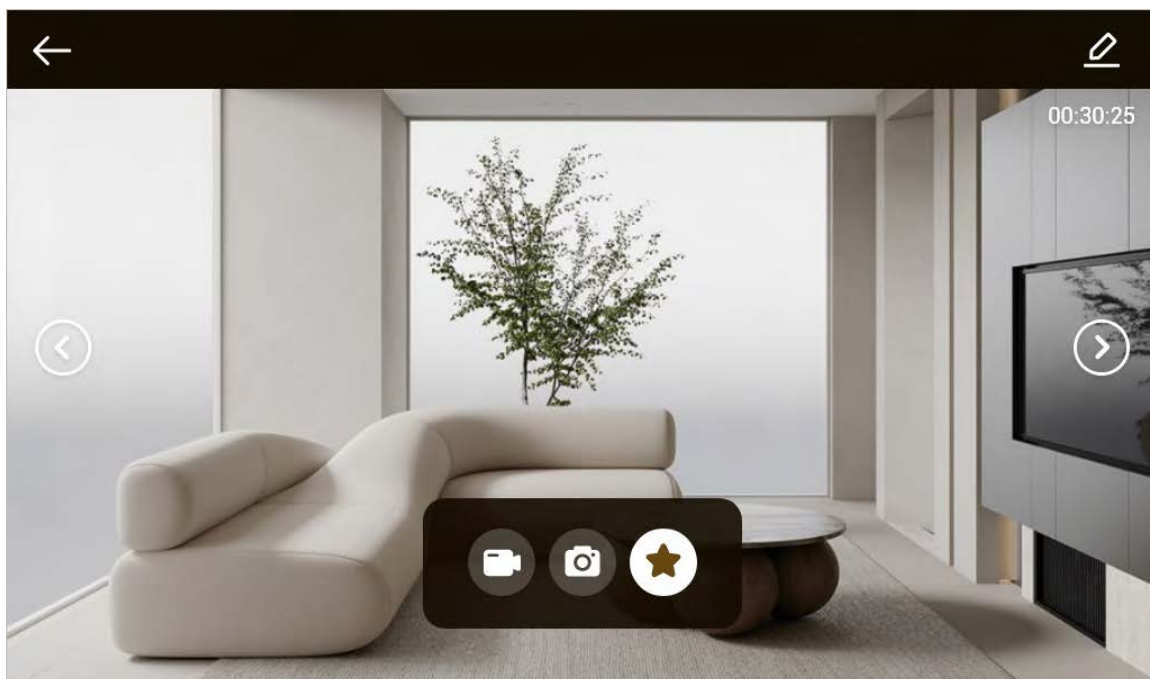

3.5.3 Favorites

Displays the VTO, fence station or IPC that have been added to favorites.





To view favorite list, please ensure that VTO, fence station or IPC have been added to favorites. Otherwise, the list is empty.

Procedure

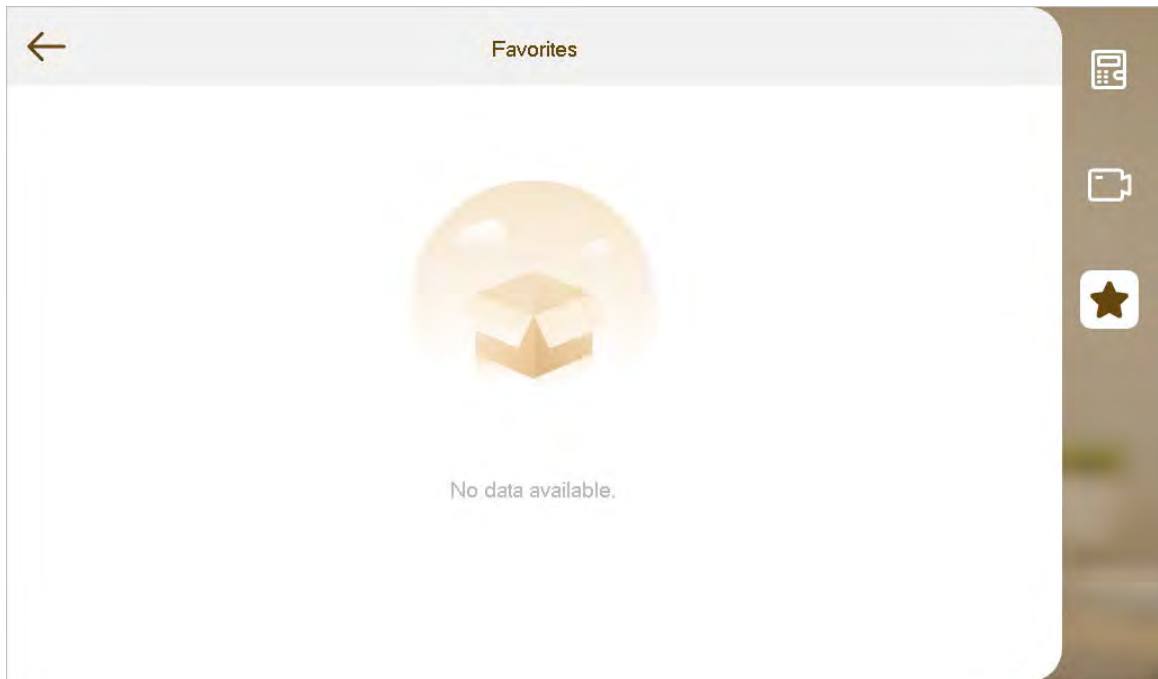

Step 1 Select **Monitor** > .

Figure 3-23 Favorites



Step 2 Select the device to be monitored, and tap .

The system displays monitoring interface. In case of multiple devices in **Favorites** tab,

tap  /  to switch and monitor them.

3.6 Setting

3.6.1 Call Settings

Set VTO ring, VTH ring, alarm ring and other rings.



- There is an SD card on the VTH, and users can import ring tones to the SD card.
- Ring tones must be stored in the /Ring folder at the root directory of the SD card.
- The SD card is available on select models.
- Audio files must be .pcm files (audio files of other formats cannot be played if you change their extension names).
- Audio file size must be less than 100 KB.
- Ring tone format: .pcm.
- You can only customize 10 ring tones. Other ring tones will not be displayed at the VTH.

3.6.1.1 VTH Ring

Set the ring for this VTH.

Procedure

Step 1 Select **Setting** > .

Figure 3-24 Call setting

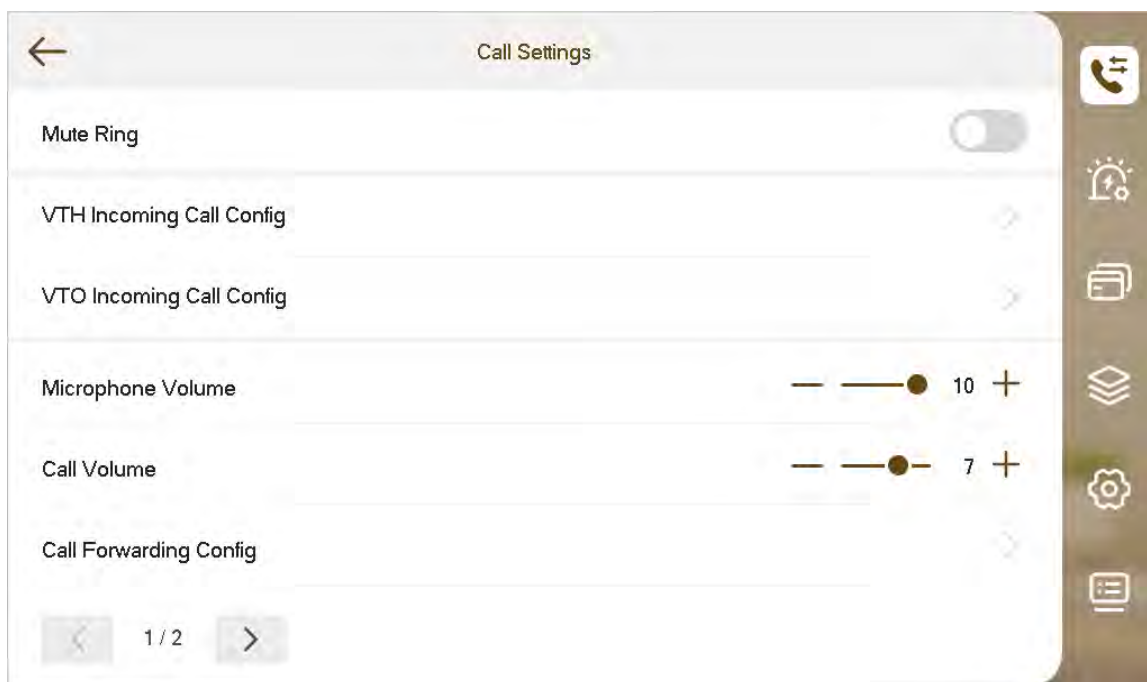

Step 2 Tap **VTH Incoming Call Config**, and then configure the parameters.

Figure 3-25 VTH ring setting

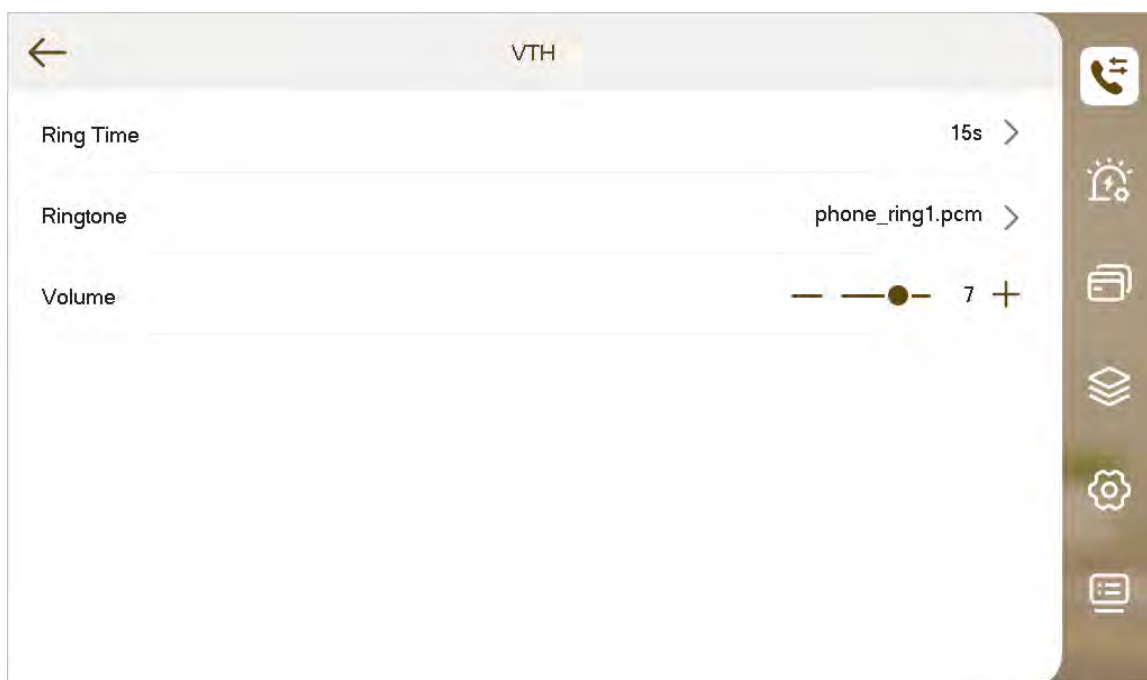

Table 3-5 VTH ring parameters description

Parameter	Description
Ring Time	Configure the ring time when another VTH calls this VTH. You can configure the time from 5 s to 120 s. It is 15 s by default.
Ringtone	Select the ringtone for the incoming call.
Volume	Tap + and – to adjust the volume.

3.6.1.2 VTO Ring

Set a ring for the connected VTO, and the device supports to set maximum 20 VTOs.

Procedure

Step 1 Select **Setting** > .

Step 2 Tap **VTO Incoming Call Config**, and then configure parameters.

Figure 3-26 VTO ring setting



Table 3-6 VTO ring parameters description

Parameter	Description
Ring Time	Configure the ring time when a VTO calls this VTH. You can configure the time from 15 s to 120 s.
Time for Voice Message	Configure the time for voice message. You can configure the time from 0 s to 90 s.

Parameter	Description
Call Time	Configure the call time for the incoming call. You can configure the time from 5 s to 300 s.
Ringtone	Select the ringtone and adjust the volume for the VTOs.

3.6.1.3 Forward Setting

Forward incoming calls.



Parameters at this interface are set on main VTH only, and extension VTH synchronizes with the main VTH.

Procedure

Step 1 Select **Setting** >

Step 2 Tap **Call Forwarding Config**.

Figure 3-27 Call forwarding



Step 3 Enter the VTH number in the corresponding forward mode, and then tap to enable the forward function.



- If you enable 3 functions at the same time, the forward priority is **Always Forward** > **Forward when Busy** > **Forward when Not Answered**.
- If the call is hang up, the call will be forwarded to the number that configured in **Forward when Busy**.

Table 3-7 Description of call forwarding parameters

Parameter	Description
Always Forward	All incoming calls will be forwarded to preset number immediately.
Forward when Busy	When the user is busy, incoming call from the third party will be forwarded to preset number.
Forward when Not Answered	If no one answers after VTH ring time, the incoming call will be forwarded to preset number. Set VTH ring time at Setting >  > VTH Incoming Call Config screen.



- To forward to a user of another building or unit, the forward number is Building + Unit + VTH room number. For example, input 1#1#101 for 101 of Unit 1, Building 1.
- To forward to a user of the same unit, the forward number is VTH room number.
- To forward to the app, the forward number should be in the range of 100 to 199, and avoid the group number of the current VTH.
- To forward to the platform, the forward number is 888888 by default.

3.6.1.4 Other Ring Settings

Set MIC volume, talk volume and ring mute function.



VTO Ring and **VTH Ring** of extension VTH are synchronized with main VTH, and cannot be set.

Procedure

Step 1 Select **Setting** > .

Figure 3-28 Call setting (1)

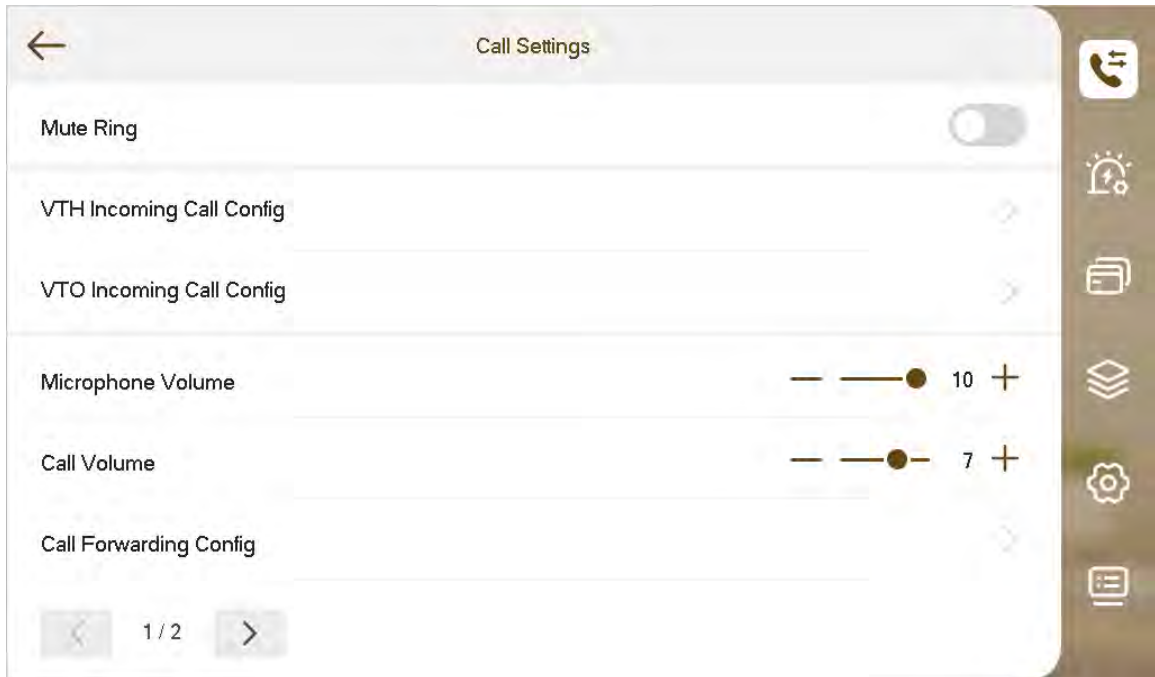
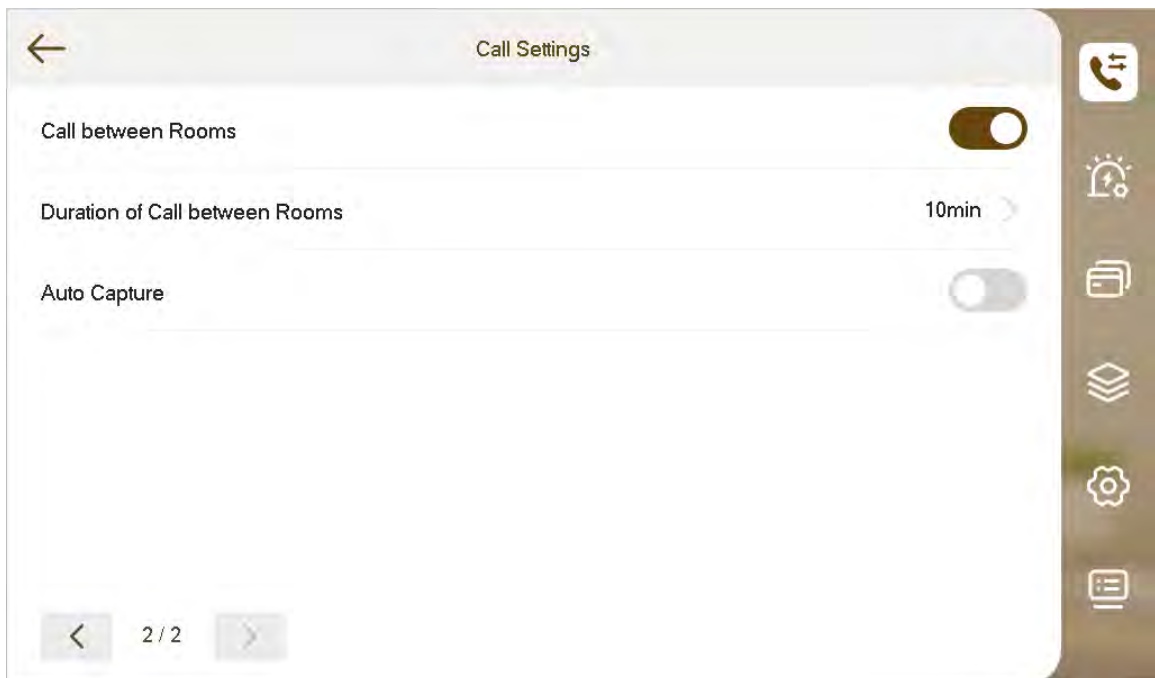







Figure 3-29 Call setting (2)



Step 2 Configure the parameters.

Table 3-8 Description of call setting parameters

Parameter	Description
Mute Ring	Tap  to enable Mute Ring .
Microphone Volume	Tap + and - to adjust the microphone volume.
Call Volume	Tap + and - to adjust the call volume.

Parameter	Description
Call between Rooms	Tap  to enable this function.
Duration of Call between Rooms	Configure the duration of call between rooms. You can configure the time from 5 min to 60 min.
Auto Capture	Tap  to enable Auto capture . After enabled, one picture will be captured automatically when the VTO calls the VTH. Tap Info >  to view them..  <ul style="list-style-type: none"> • An SD card is needed for this function. • After enabling auto capture, Auto Delete Snapshots after Call Answered will be displayed, which when turned on, snapshots will be deleted if the VTH answers the call.

3.6.2 Alarm Setting

Set wired zone, call linkage and alarm volume



Zones can be set under disarm mode.

3.6.2.1 Wired Zone

Set zone type, alarm status and delay time. You can set up to 8 zones.

Procedure

Step 1 Select **Setting** > .

Step 2 Tap **Wired Zone**.

Figure 3-30 Wired zone

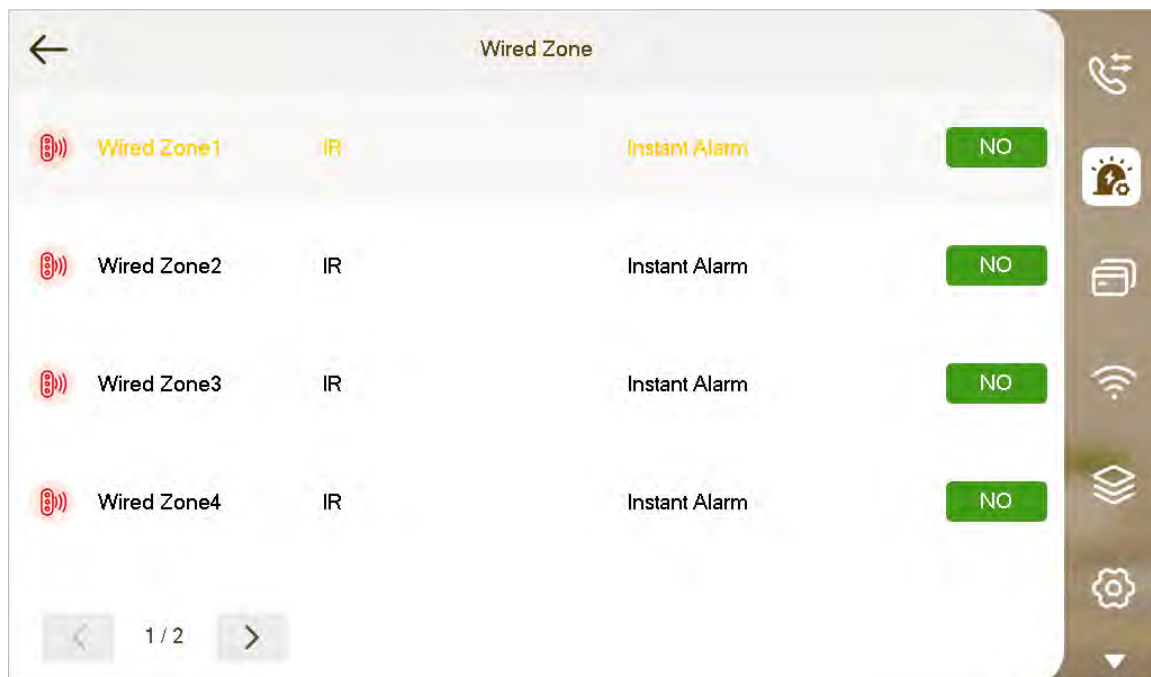

Step 3 Tap the wired zone name to configure the zone.

Table 3-9 Description of wired zone parameters

Parameter	Description
Zone No.	The number cannot be modified.
Zone Type	Select the corresponding type according to the detector type, including IR, gas, smoke detector, emergency button, door detector, burglar, perimeter and doorbell. Different types have different icons displayed.
NO/NC	Select NO (normally open) or NC (normally closed) according to the detector type. It must be the same as the detector type.
Alarm Status	<ul style="list-style-type: none"> ● Instant Alarm : When armed, if an alarm is triggered, the device produces a siren at once and enters the alarm status. ● Delay Alarm : When armed, if an alarm is triggered, the device enters the alarm status after a specified time, during which you can disarm and cancel the alarm. ● Bypass : Alarms will not be triggered in the area. After the area is disarmed, it will be restored to its normal working status. ● Remove : The area is invalid during arming and disarming. ● 24 Hour : Alarms will be triggered all the time in the area, regardless of whether it is armed or disarmed. <p> A zone in the Remove status cannot be bypassed.</p>



Parameter	Description
Entry Delay Time	<p>Configure the time.</p> <p>After configuring the Delay Alarm status for the area, if you enter the area from an unarmed area within the delay time, a linkage alarm will not be triggered. If the delay time comes to an end and the area is not disarmed, a linkage alarm will be triggered.</p> <p></p> <p>The configured time is only effective in areas with Delay Alarm.</p>
Exit Delay Time	<p>Configure the time.</p> <p>After configuring the Delay Alarm status for the area, if the delay time comes to an end, the area will enter the arming status.</p> <p></p> <ul style="list-style-type: none"> • The configured time is only effective in areas with Delay Alarm. • If multiple areas have an exit delay time configured, a prompt will appear stating the maximum delay time.

Figure 3-31 Zone settings



3.6.2.2 Wireless Zone

Add, delete and set wireless zones.

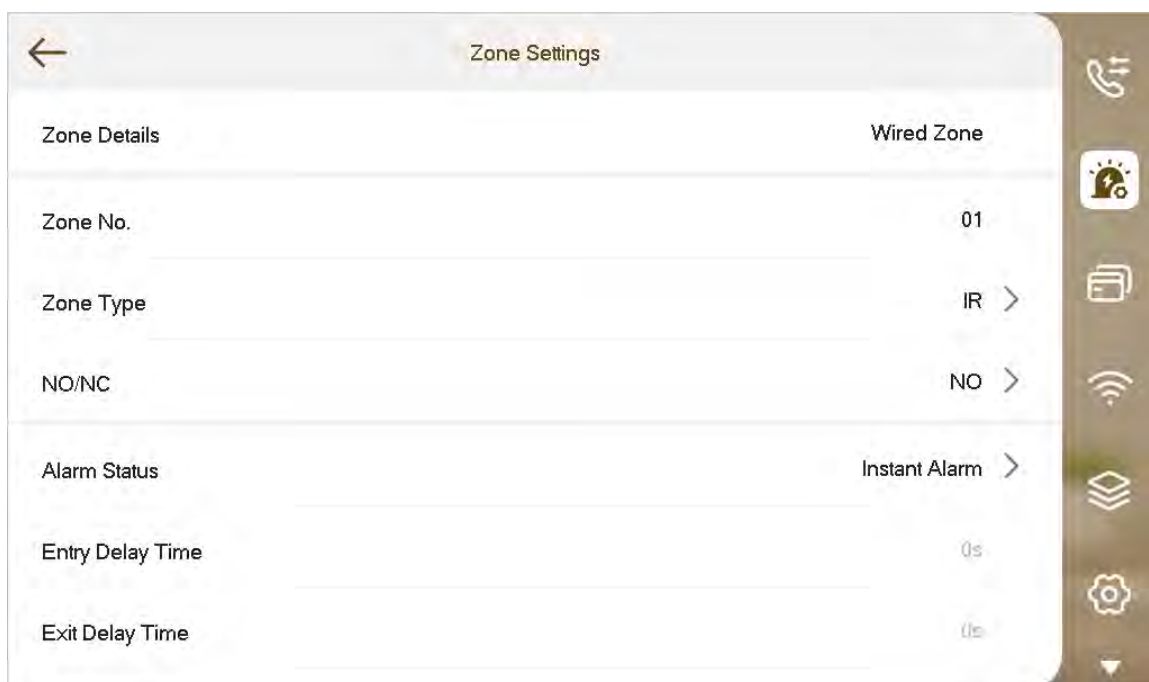

- For devices with the wireless function, the **Wireless Zone** tab would appear after you enable **433** in **General Setting** > **Other**.
- The actual screen of the **Wireless Zone** might differ depending on the model you use. The image is for reference only.

Procedure

Step 1 Select **Setting** > .

Step 2 Tap **Wireless Zone**.

Figure 3-32 Wireless zone

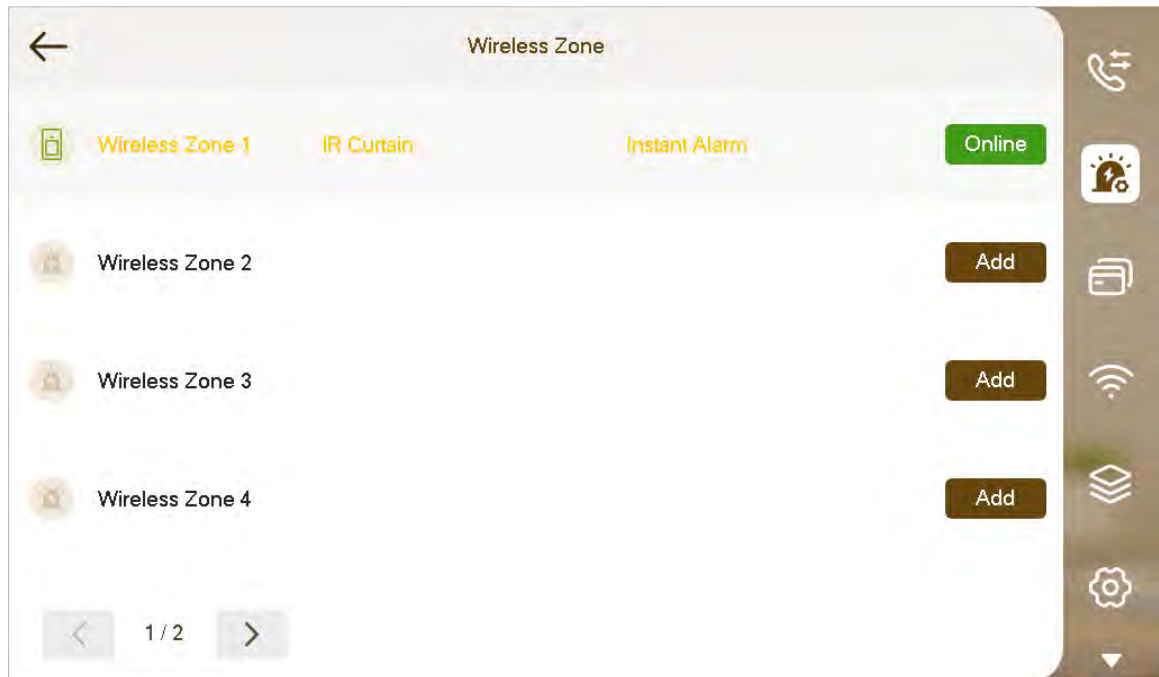

Step 3 Tap **Add**.

Step 4 Tap the wireless code button on the wireless device. See wireless device user's manual for details.

After coding is successful, the area information will be displayed.

Step 5 Tap the wireless zone name to configure the zone.



The **Instant Alarm** status cannot be configured for the wireless zone.

3.6.2.3 Other Alarm Settings

Set call linkage, local linkage, the ringtone and the volume.

Procedure

Step 1 Select **Setting** > .

Figure 3-33 Alarm setting

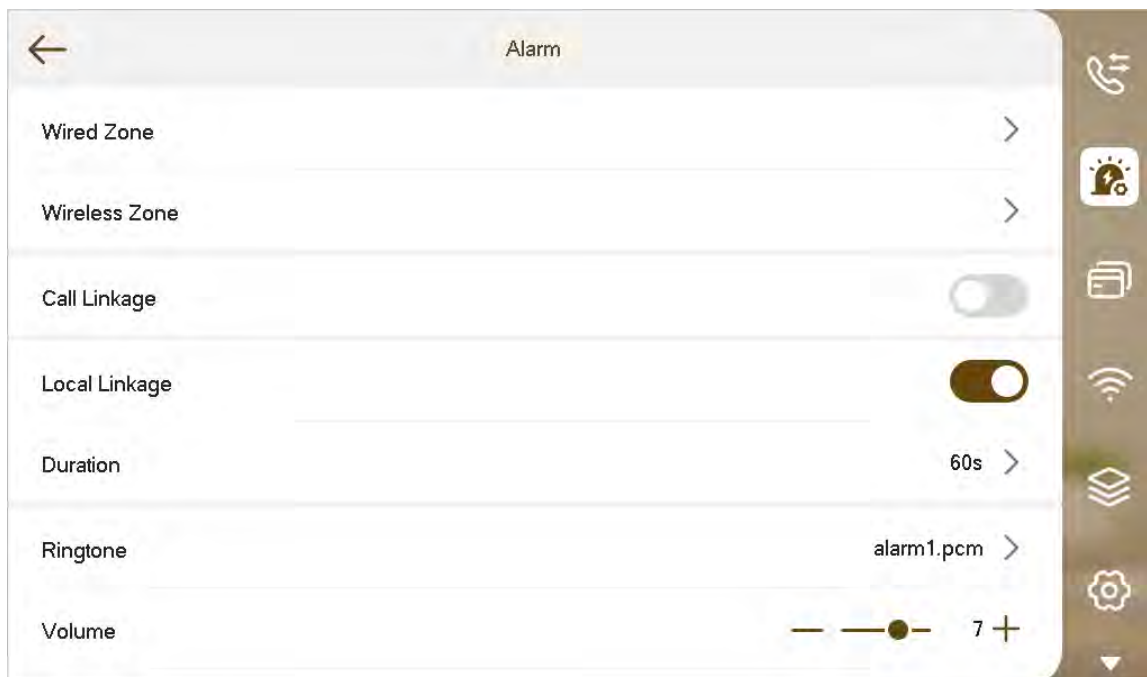

Step 2 Configure the parameters.

Table 3-10 Description of other alarm settings

Parameter	Description
Call Linkage	If enabled, there will be alarm output when you call.
Local Linkage	If enabled, there will be alarm output of the local alarm device that links with the VTH.
Duration	Configure the alarm duration from 5 to 120 seconds.
Ringtone	Select the ringtone
Volume	Tap + and – to adjust the call volume.

3.6.3 Card Management

Issue and manage card information.



This function is only available when you select **Villa** as the device scene during the initialization.

Procedure

- Step 1** Click **Issue Card**.
- Step 2** Swipe the card on the corresponding VTO.
- Step 3** The card information will be added to the VTH. Select from **Lock 1** and **Lock 2** to assign unlock permissions.
- Step 4** Click **Confirm**.



Tap **Delete** to delete the card information.

3.6.4 WLAN

- The WLAN function is only available on select models.
- Use a router with secured encryption protocols.
- The wired network IP and the WLAN IP cannot be set in the same segment.

WLAN





1. Select **Setting** > , and then tap **WLAN**.
2. Tap , select a Wi-Fi, and then enter the password to connect to the network.

Figure 3-34 Wi-Fi

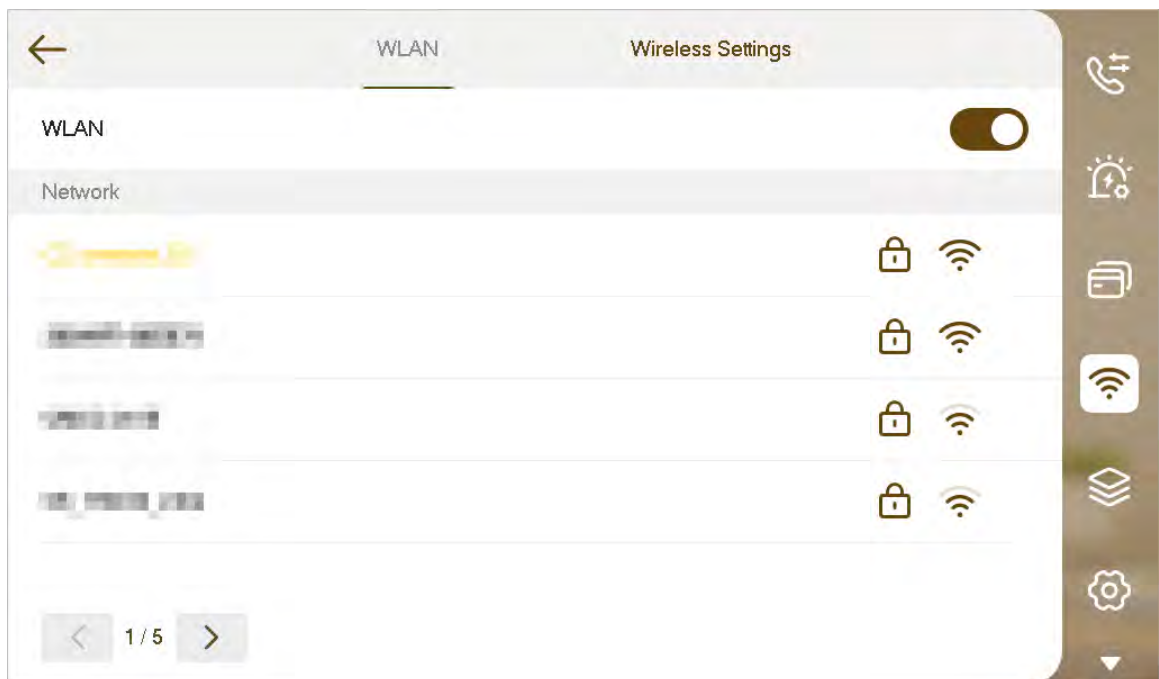

Wireless IP

1. Select **Setting** > .
2. Tap **Wireless Settings**.
3. Enter the IP address, subnet mask and the gateway, and then tap **OK**.



You can also tap **Wireless Settings**, and turn on **DHCP** to obtain the information automatically.

3.6.5 Mode Setting

Set the area status under different modes.



Area mode can only be set when the system is disarmed.

Procedure

Step 1 Select **Setting** >

Step 2 Select any or the 4 arming modes.

- **Home:** Arm the system when you are inside the area of the alarm system.
- **Away:** Arm the system when you leave the area of the alarm system.
- **Sleep:** Arm the system when you are in the sleep time.
- **Custom:** Arm the system based on your customized needs.

Step 3 Turn on or turn off the area you selected to enable or disable the arm mode.



- Multiple areas can be added into one arm mode at the same time.
- One area can be added into different modes.

Figure 3-35 Mode setting area

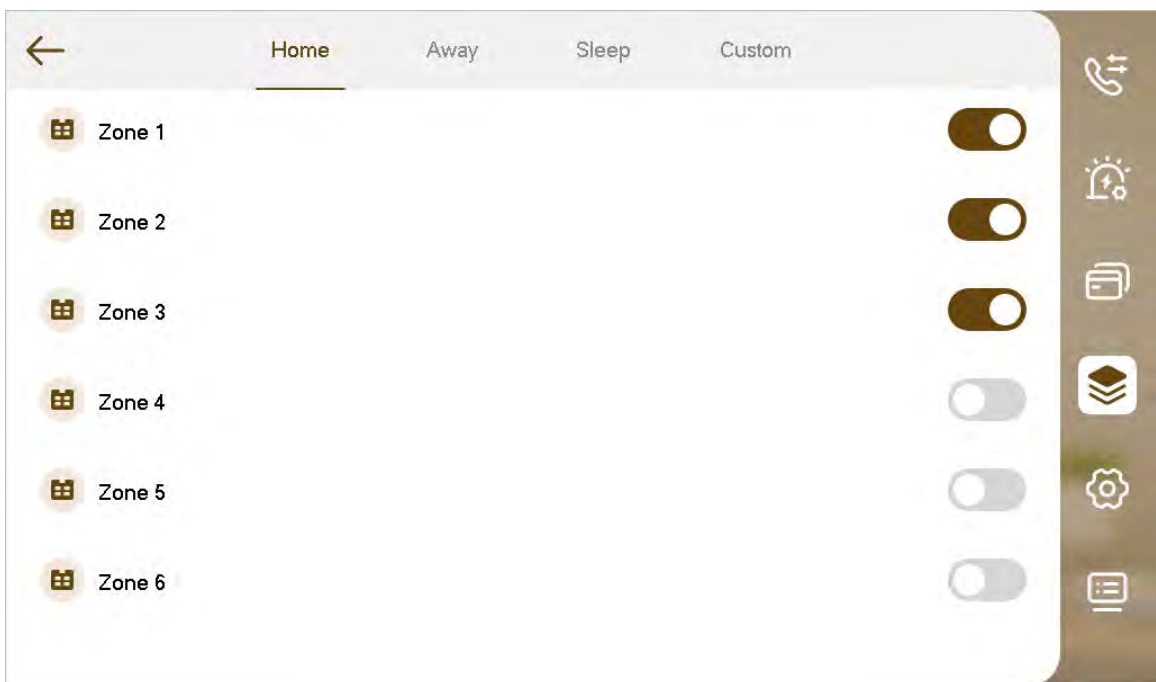

Step 4 (Optional) Tap to page down the screen to **Wireless Zone**. Turn on the area to add it to the arm mode, or turn off the area to remove it from the arm mode.



- For devices with the wireless function, the wireless zone can be configured after you enable **433** in **General Setting** > **Other**.
- Multiple areas can be added into one arm mode at the same time.
- One area can be added into different modes.

Figure 3-36 Wireless area

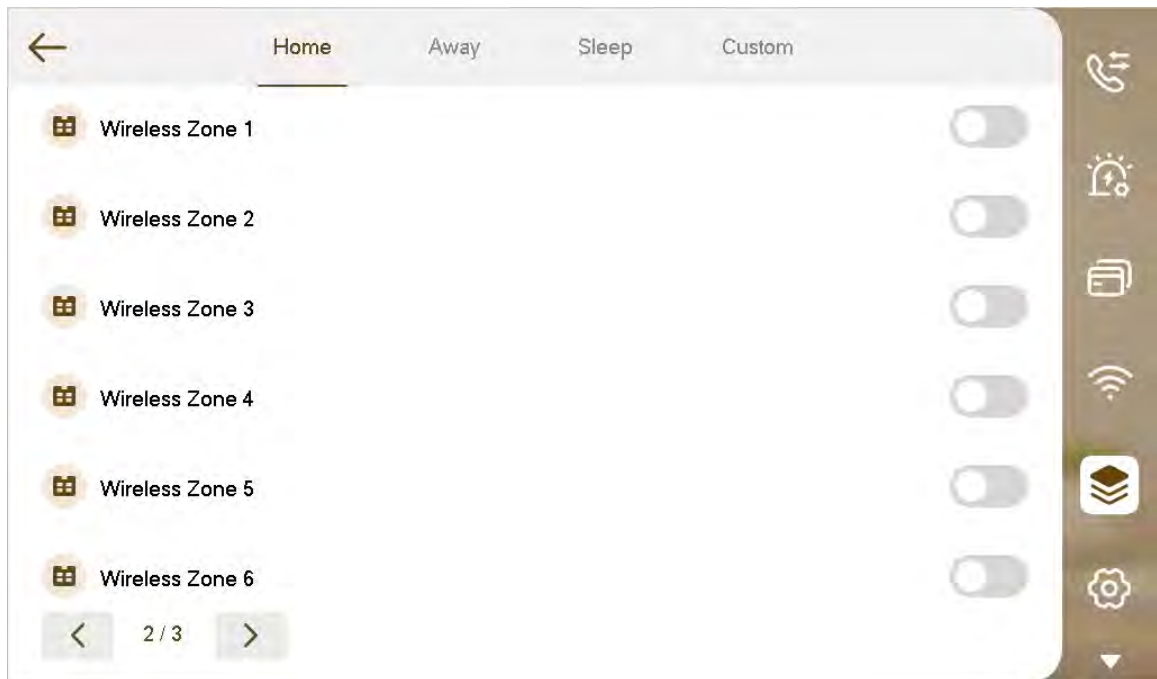

3.6.6 General Setting

Set VTH time, display, password and others.

3.6.6.1 Time Setting and DND

Set VTH system time, time zone, and DND.



Parameters at this screen are set on main VTH only, and extension VTH synchronizes with main VTH.

Procedure

Step 1 Tap **Setting**.

Step 2 Select  > **Time**.

Figure 3-37 Time setting

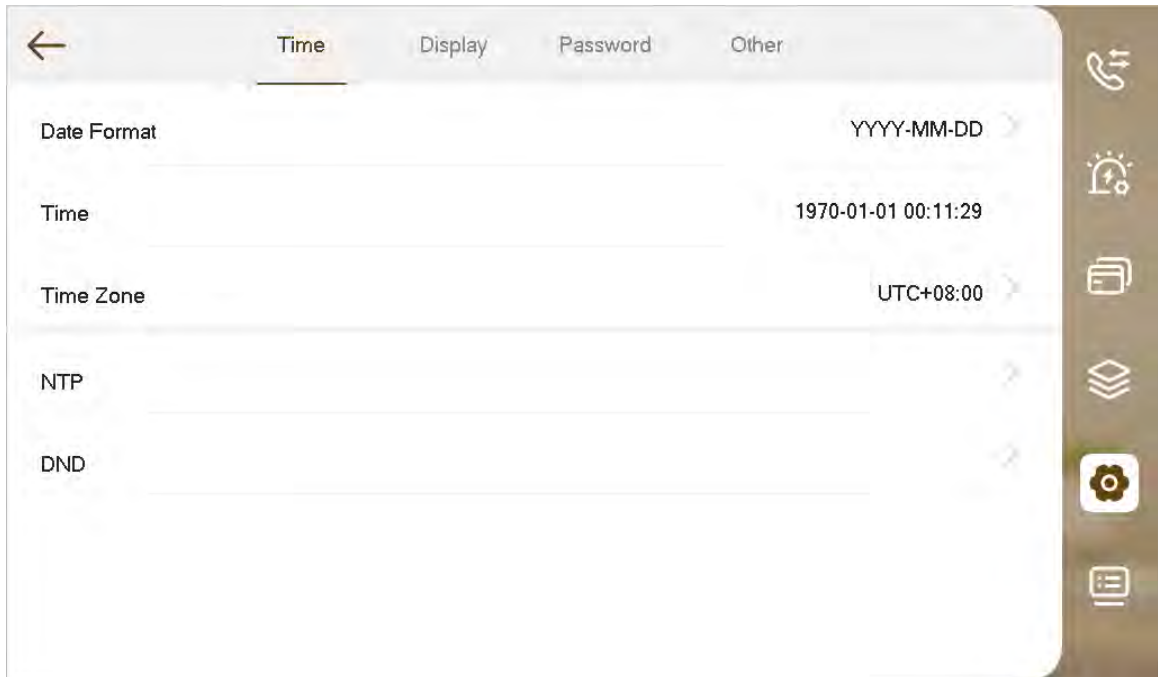

Step 3 Configure the time parameters.

- Select the date format and the time zone.
- Tap **NTP**.
 - ◇ If enabled, configure the address, port of the NTP server and the interval. The VTH will synchronize time with the NTP server.
 - ◇ If you turn off **NTP**, configure the time and time zone manually.
- Tap **DND**.

If enabled, configure the start and end time, and then select the days that you want to repeat the DND mode. You will not receive any call or message during this period.



You can directly enable **DND** by tapping  on the home screen. Tap it again to turn it off.

3.6.6.2 Display Setting

Set VTH screen brightness, screensaver time and turn off the screen to clean it.



The snapshots are for reference only, and might differ from the actual screen.

Procedure

Step 1 Tap **Setting**.

Step 2 Select  > **Display**.

Figure 3-38 Display

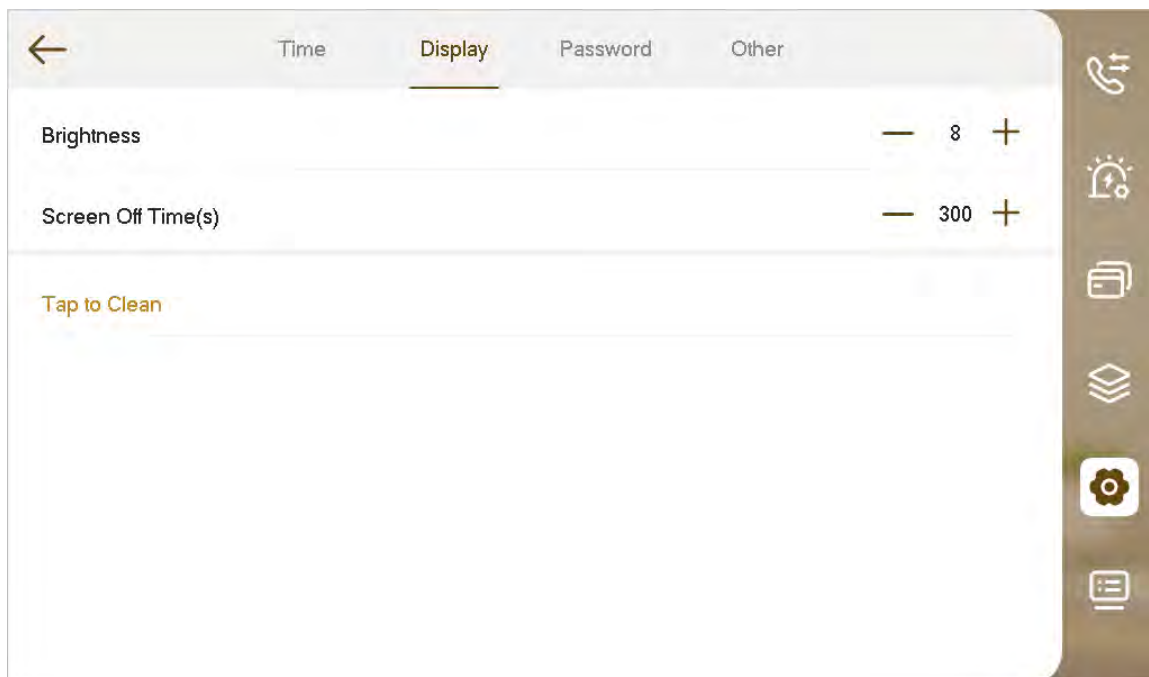

Step 3 Set parameters.

- **Brightness:** The brightness of the VTH screen. Adjust the brightness by taping + or –.
- **Screen Off Time(s):** The screen will automatically turn off after a define time of inactivity. Adjust the time by taping + or –.
- **Tap to Clean :** Tap it, and then the screen will be turned off and locked for 30 seconds. During the period, clean the screen.

3.6.6.3 User Password Setting

The user password is used to enter the arm and disarm mode and unlock doors. You can change the password.

Procedure

Step 1 Tap **Setting**.

Step 2 Select  > **Password**.

Figure 3-39 Password

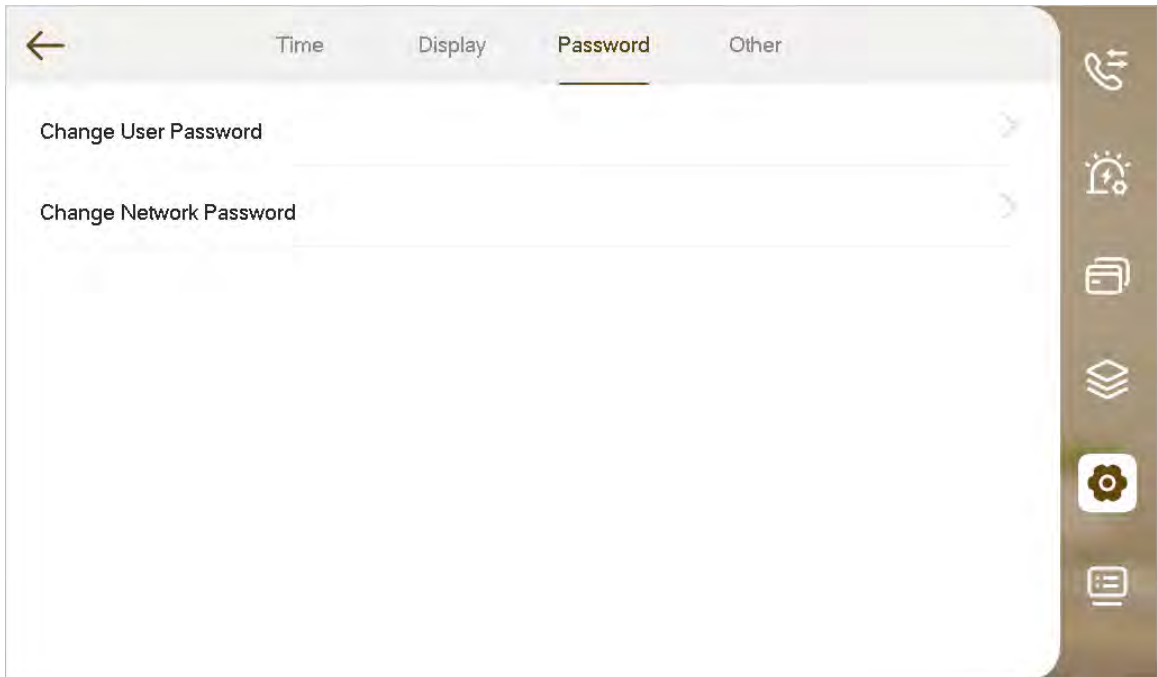

Step 3 Tap **Change User Password**, and then enter the old password, new password and then confirm password.

Figure 3-40 User password

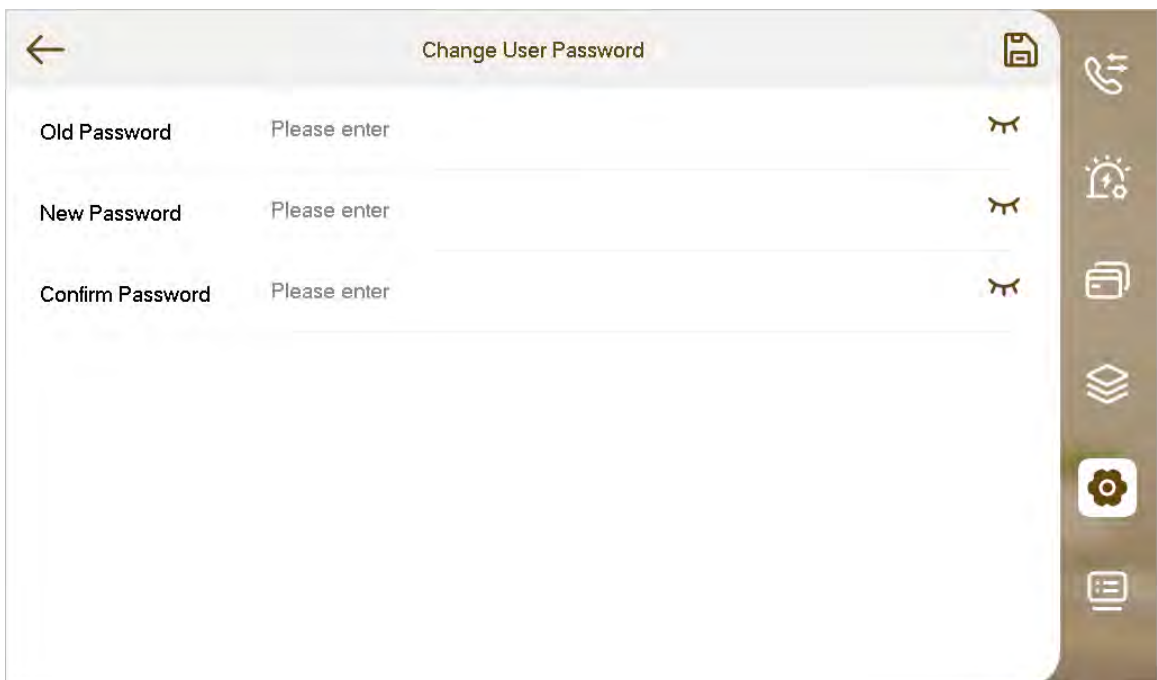

Step 4 Tap  to save the configuration.

3.6.6.4 Network Password Setting

The network password is used when adding the VTH to the DMSS app.

3.6.6.4.1 Creating Network Password

Procedure

Step 1 On the home screen, select **Setting** >  > **Password**.

Step 2 Tap **Change Network Password**.

Step 3 Enable the cloud function.

Step 4 Enter the password you planned and then confirm it.



- The username is **user** by default.
- The password must consist of 8 to 16 characters.

Figure 3-41 Network password

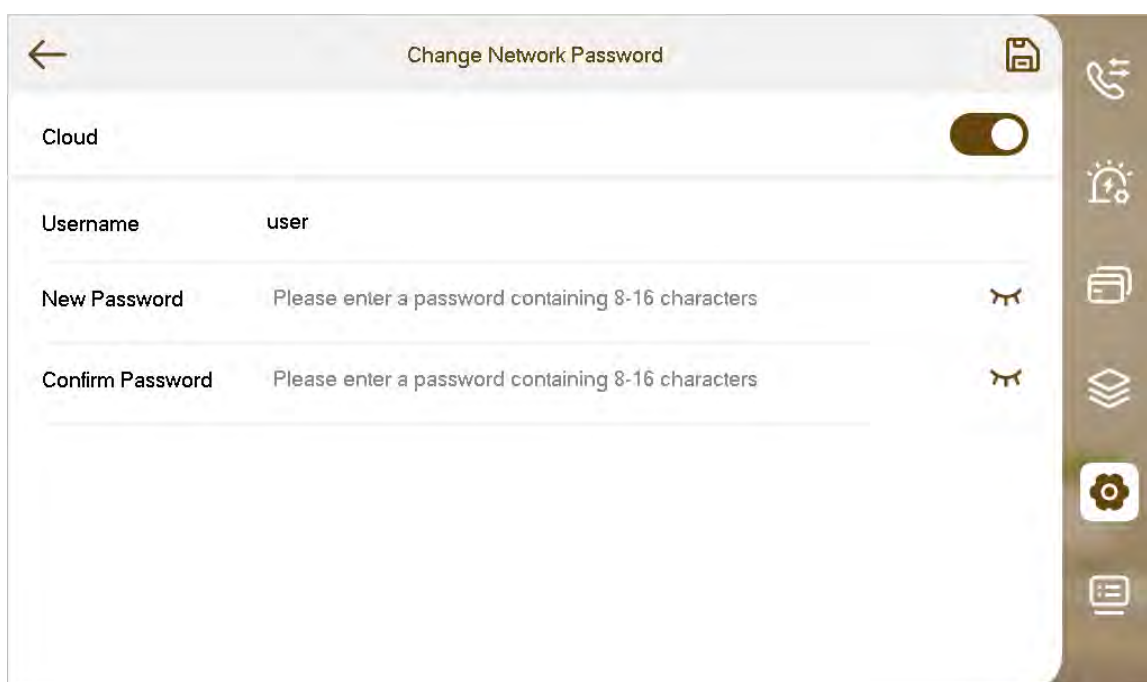

Step 5 Tap .

Results

The VTH would automatically generate a QR code that contains the **User** account. When you scan the DMSS QR code by tapping  on the home screen, the DMSS App would obtain the VTH information.



When going to the QR Code screen for the first time, the **DMSS** QR code would not appear. Only after you set the network password, this module would be displayed.

Figure 3-42 DMSS onscreen prompt

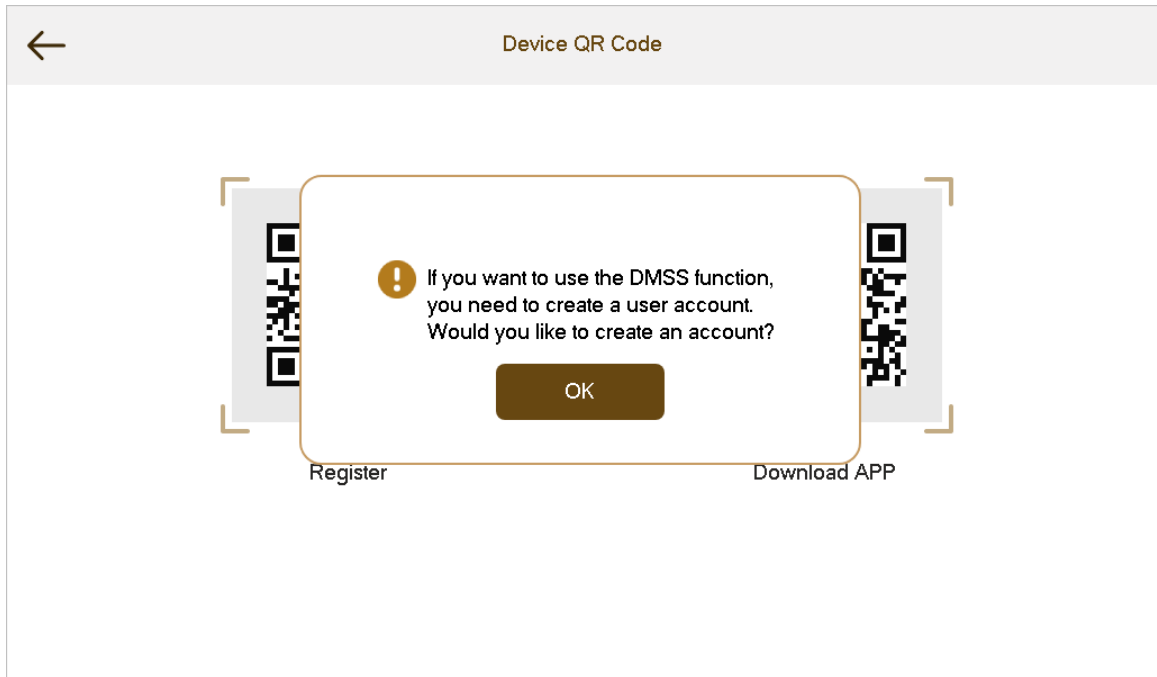
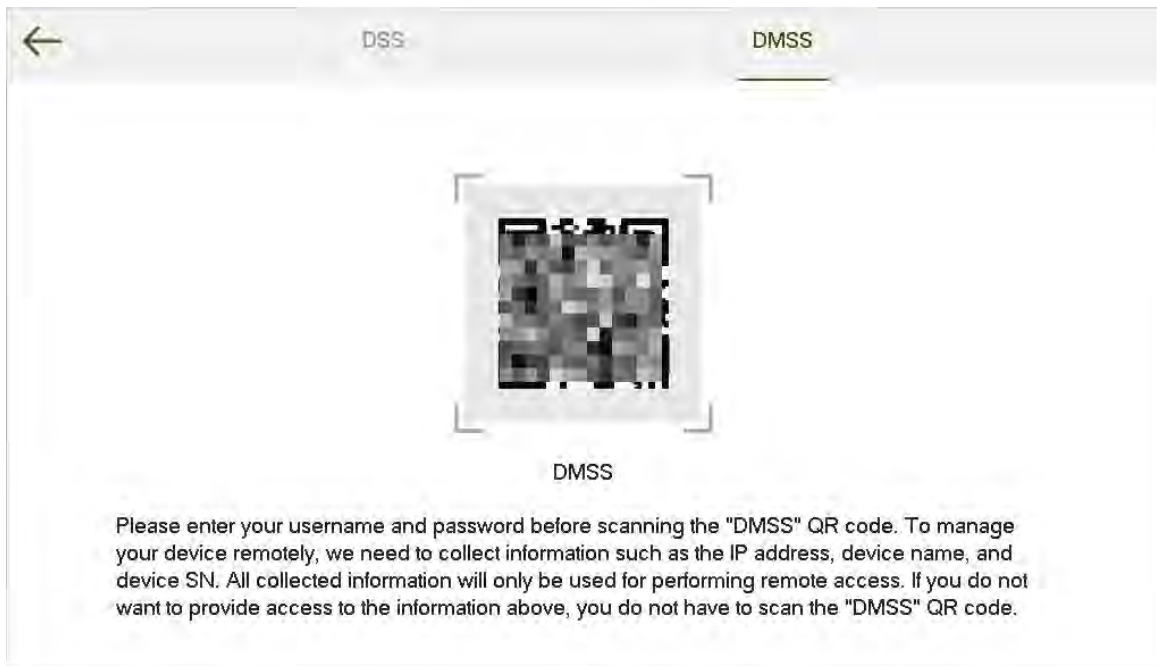

Figure 3-43 DMSS QR code



3.6.6.4.2 Changing Network Password

Change your current network password.

Procedure

- Step 1** On the home screen, select **Setting** >  > **Password**.
- Step 2** Tap **Change Network Password**.
- Step 3** Enter the old password, new password and then confirm it.

Figure 3-44 Network password



Step 4 Tap .

3.6.6.4.3 Resetting Network Password

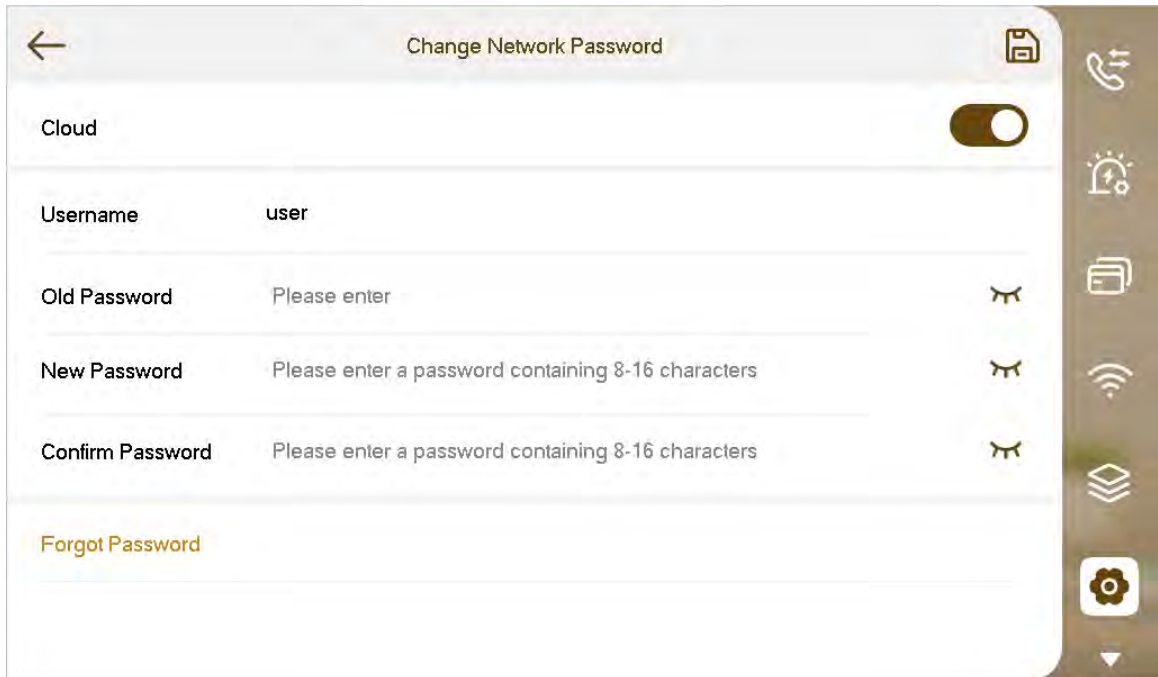
When you forget your network password, you can reset it to create a new one.

Procedure

Step 1 On the home screen, select **Setting** >  > **Password**.

Step 2 Tap **Change Network Password**.

Step 3 Tap **Forgot Password**, enter the password that you configure during the initialization in the **Password Verification** window, and then enter the new password and confirm it.

Step 4 Tap .

3.6.6.5 Other Settings

Set monitor time, record time and touch sound.



Extension VTH can set touch sound, touch delay and 433, but other parameters synchronize with main VTH and cannot be set.

Procedure

Step 1 Tap **Setting**.

Step 2 Select  > **Other**.

Figure 3-45 Other settings

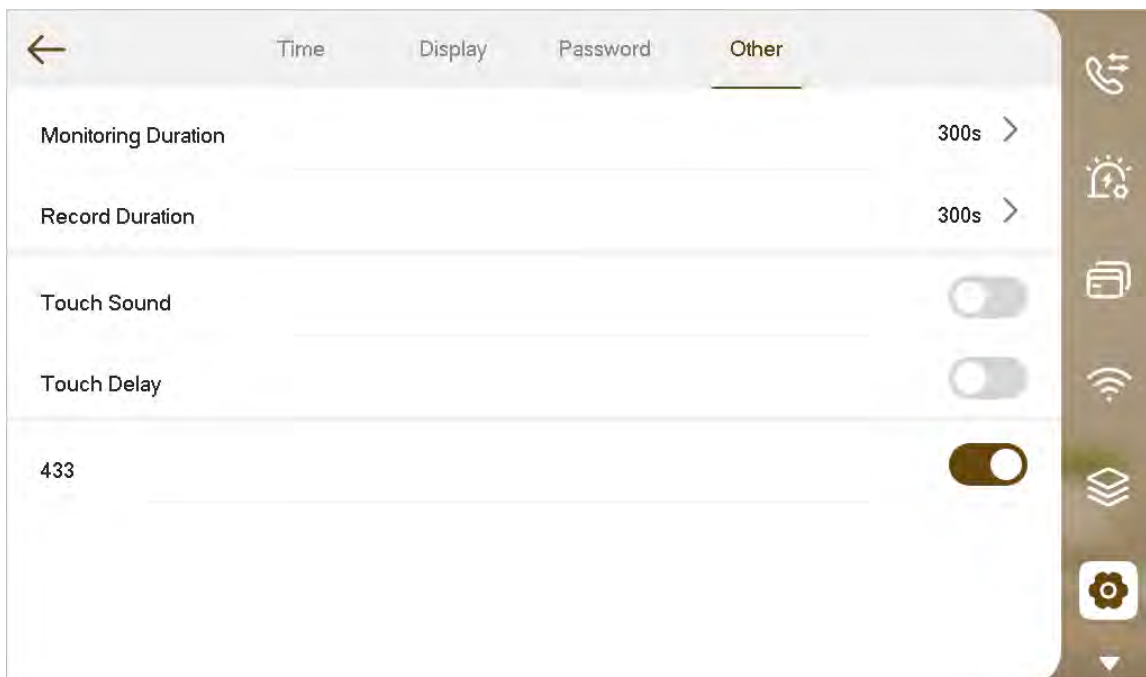

Step 3 Configure the parameters.

Table 3-11 Description of other setting parameters

Parameter	Description	Operation
Monitoring Duration	Maximum time to monitor VTO, IPC and fence station.	Configure the time. The monitoring duration can be configured from 15 s to 7200 s.
Record Duration	Maximum recording time of videos during call, talk, monitoring and speaking. The system stops recording at the end of recording time.	Configure the time. The Record duration can be configured from 15 s to 300 s.
Touch Sound	After enabling touch sound, there will be a ring when touching the screen.	Tap <input type="checkbox"/> to enable the function. The icon becomes <input checked="" type="checkbox"/> .
Touch Delay	After enabling touch delay, you need to press for longer time to call the management center.	
433	After enabling 433 function, the devices that supports wireless function would have a Wireless zone tab appeared in the alarm configuration.	

3.6.7 System Information

View the system version, select the language and view the SD card status.

Select **Setting** > .

View the version of system, security baseline and the firmware. Configure the parameters as needed.

Table 3-12 Description of system information parameters

Parameter	Description
Project Settings	Enter the password that you configure during the initialization. Configure the network parameters, SIP server parameters and other information. For details, see "3.7 Project Settings".
Language	Select the language of the device.
SD Card	View the SD card status, including the used capacity and the total capacity. You can eject the SD card or format the SD card.  The SD card is available on select models.
Cloud Upgrade	View the current device version and you can enable the cloud update function. For details, see "3.12 Cloud Update".
Restart System	Tap to restart the system.

Figure 3-46 System information (1)

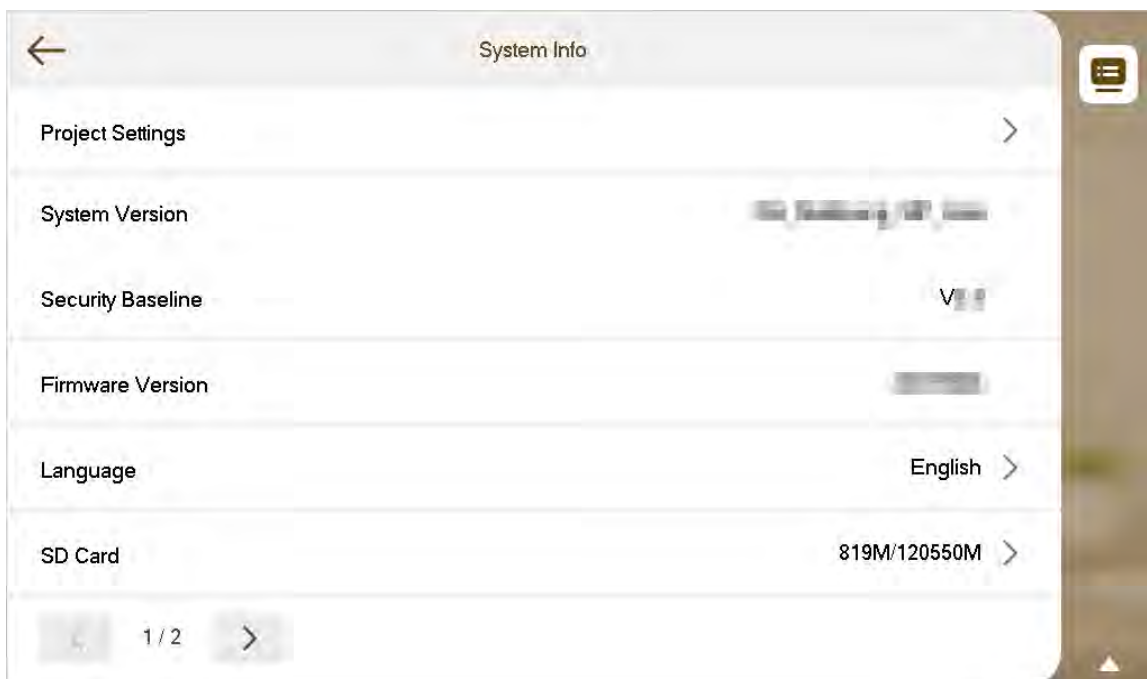
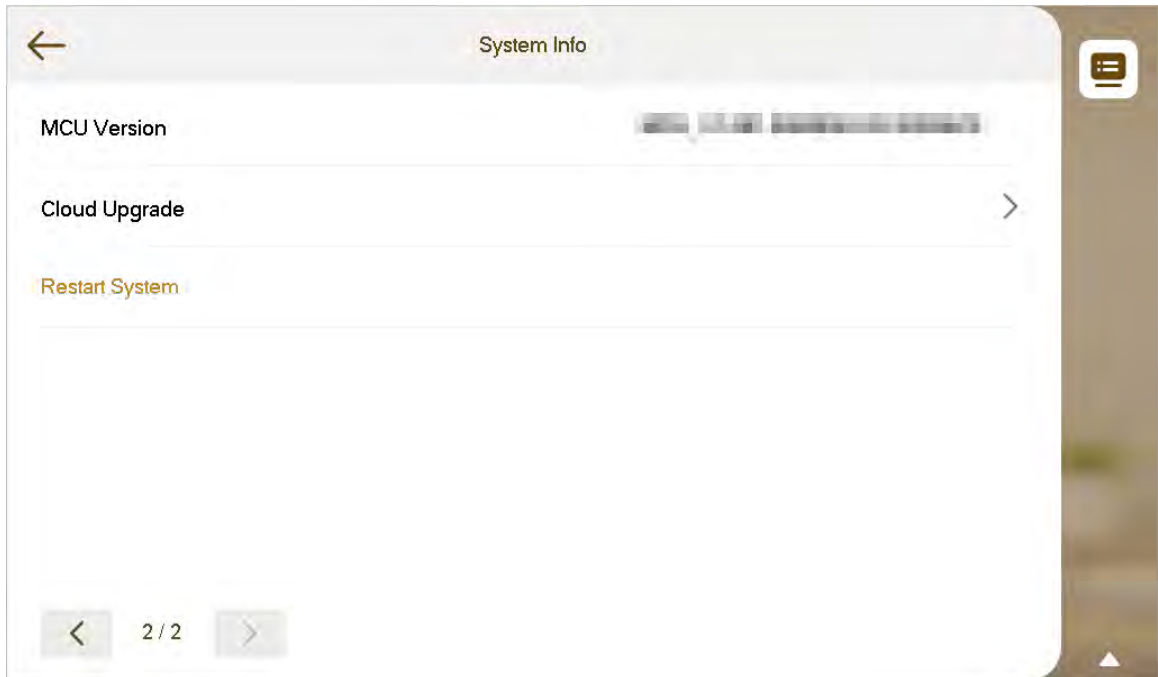

Figure 3-47 System information (2)



3.7 Project Settings

3.7.1 Forget Password

If you forget initialization password when entering project settings interface, reset password through **Forgot Password** on the screen.

Procedure

- Step 1 Select **Setting** >  > **Project Settings**.
- Step 2 On the **Password Verification** window, tap **Forgot Password**.
- Step 3 Scan the QR code with any code-scanning app, bind your email box, send it by email to the specified email address on the screen to obtain a security code.
- Step 4 Tap **Next**.
- Step 5 Enter the password and confirm it, and then enter the obtained security code.
- Step 6 Tap **OK** to complete resetting the password.

3.7.2 Network Settings

Procedure



- Step 1 On the main screen, select **Setting** >  > **Project Settings**.
- Step 2 Enter the password, and then tap **OK**.
- Step 3 Tap .
- Step 4 Enter the information, and then tap ; or turn on **DHCP** to obtain the information automatically.

Figure 3-48 Network settings (1)

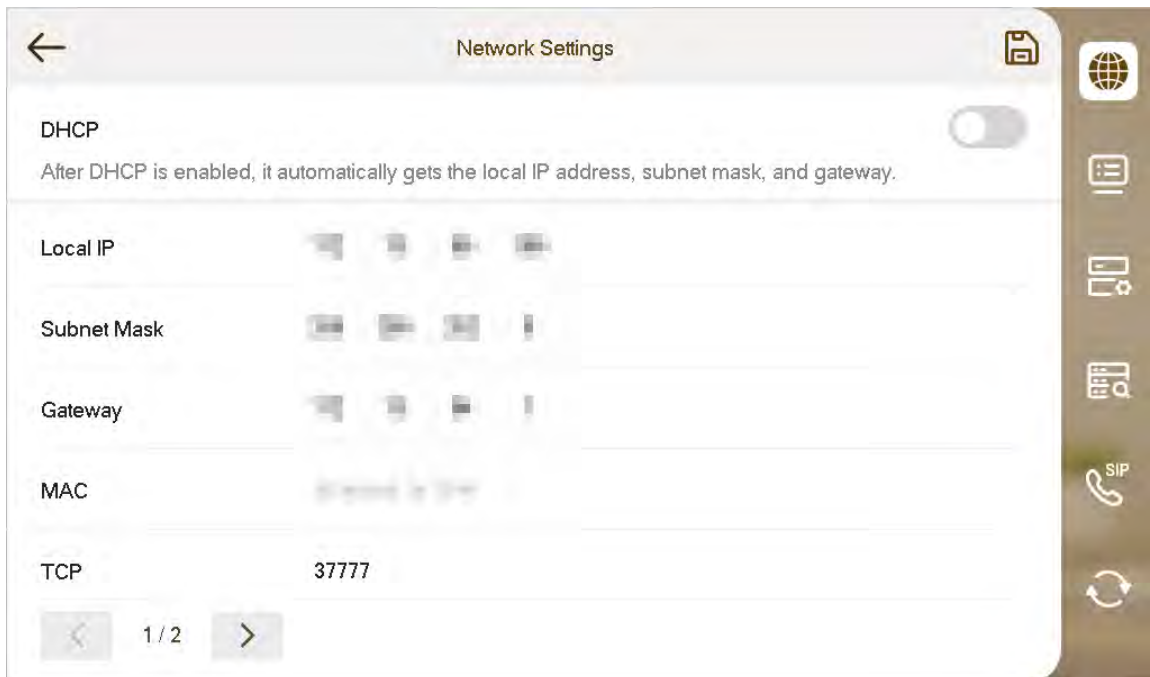
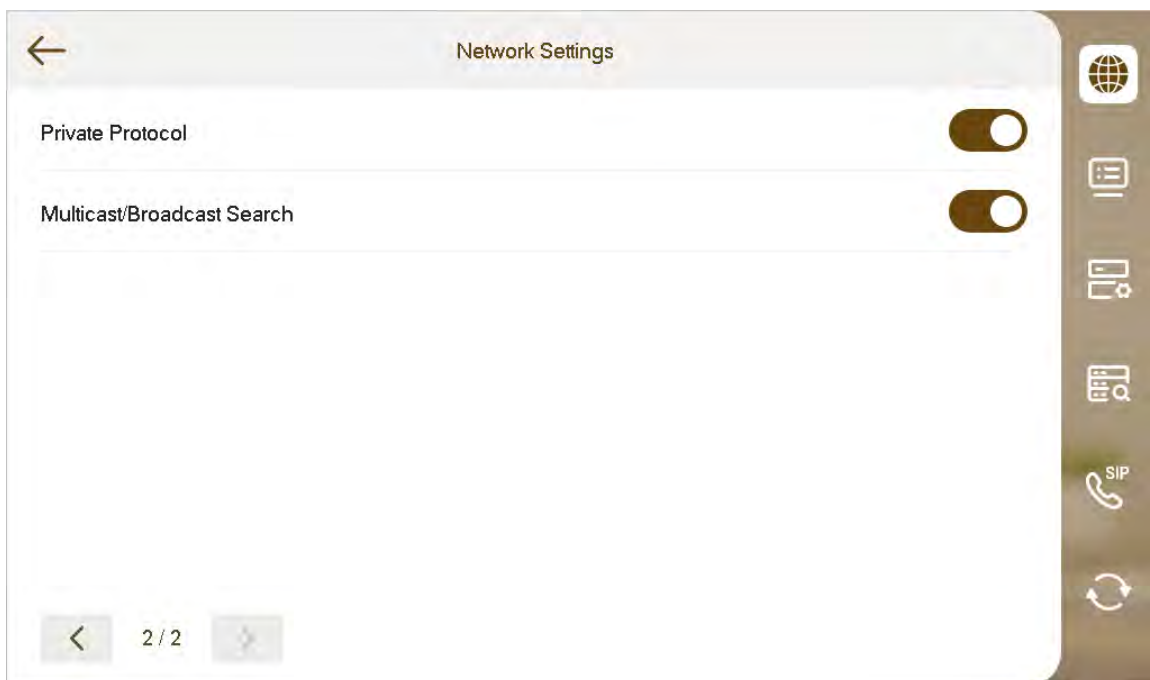

Figure 3-49 Network settings (2)



3.7.3 Configuring VTH

Procedure



- Step 1 On the main screen, select **Setting** >  > **Project Settings**.
- Step 2 Enter the password, and then tap **OK**.
- Step 3 Tap .

Figure 3-50 VTH configuration



Step 4 Configure VTH information.

Select the device type from **Set as Main VTH** and **Set as Sub VTH**.

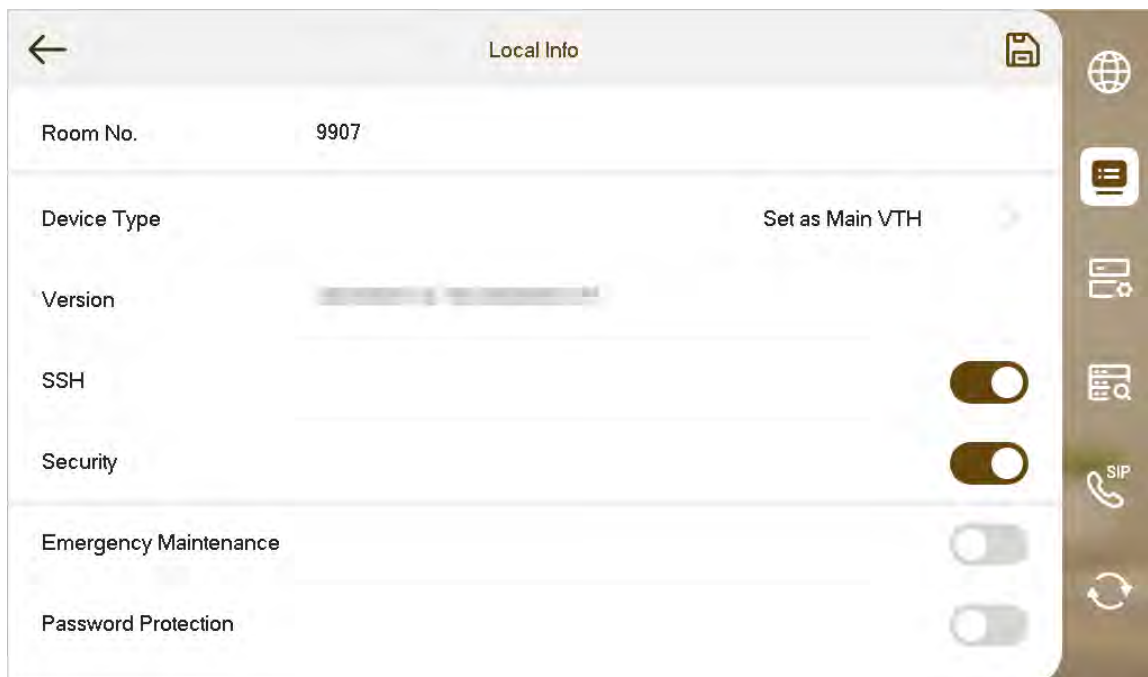
- Set as Main VTH.

Enter the room number (such as 9901 or 101#0).



Room number must be the same with **Room No.**, which is configured when adding VTHs on the VTO webpage. Otherwise, it will fail to connect to the VTO. When there are extension VTHs, room numbers must end with #0. Otherwise, it will fail to connect to the VTO.

- Set as Sub VTH.

Enter the room number (such as 101#1), IP address, username and password of the main VTH.



Default username is admin, and the password is the one set during initialization.

Step 5 Turn on the following functions as needed.

- **SSH** : The debugging terminal will connect to the VTH remotely through SSH protocol.
- **Security Mode** : Log in to the VTO in a secured way.
- **Emergency Maintenance** : The device information will be displayed when there are abnormalities.



We recommend you turn on the function for better after-sale service. If the function is not enabled manually, and there are problems with the key functions (like upgrade), the device will automatically enable it.

- **Password Protection** : Encrypt the password before sending out.



It is recommended to turn off SSH, and turn on security mode and password protection. Otherwise, the device might be exposed to security risks and data leakage.

Step 6 Tap .

3.7.4 Configuring VTO

Background Information

Add VTOs and fence stations to bind them with the VTH.

Procedure

Step 1 On the main screen, select **Setting** >  > **Project Settings**.

Step 2 Enter the password, and then tap **OK**.

Step 3 Tap .

Figure 3-51 VTO configuration

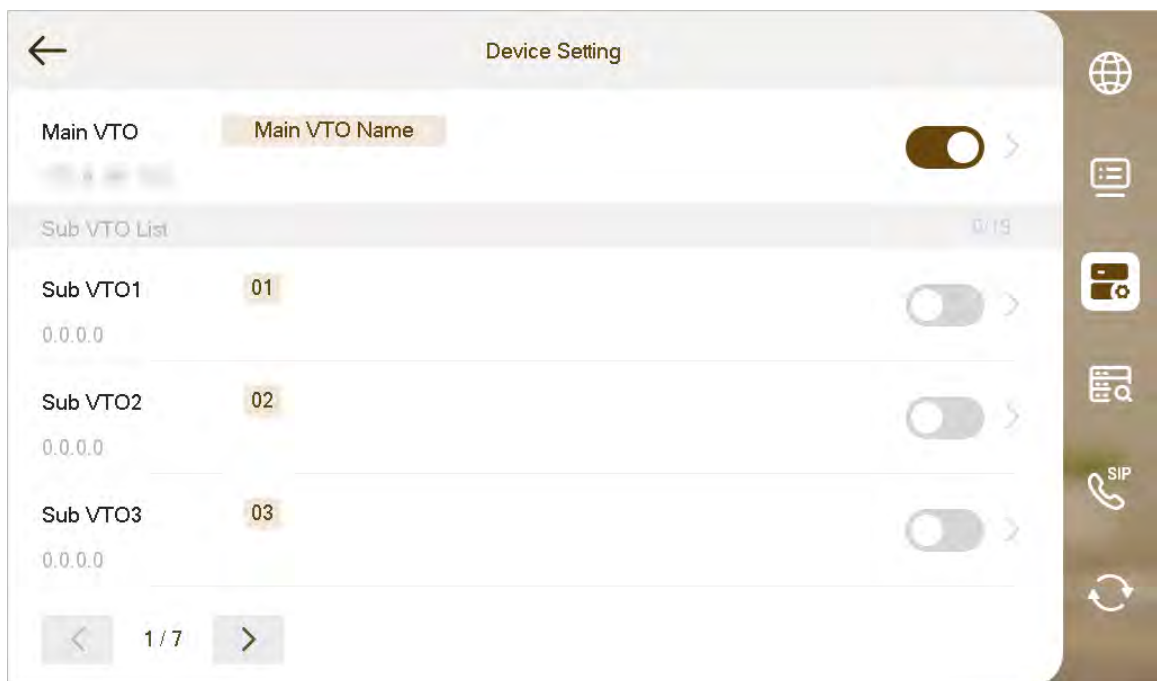

Step 4 Add a VTO or fence station.

- Add a main VTO.

1. Tap  next to the main VTO, and then enter the main VTO name, VTO IP address, username and password.

2. Tap .



Username and **Password** must be consistent with the login username and password of the VTO webpage.



3. Tap .



Figure 3-52 Main VTO configuration



- Add a sub VTO or fence station.

1. Tap  next to the sub VTO, and then enter the sub VTO or fence station name, IP address, username and password.

2. Tap  .

Tap  or  to turn page and add more sub VTOs or fence stations.

3. Tap .

Figure 3-53 Sub VTO configuration

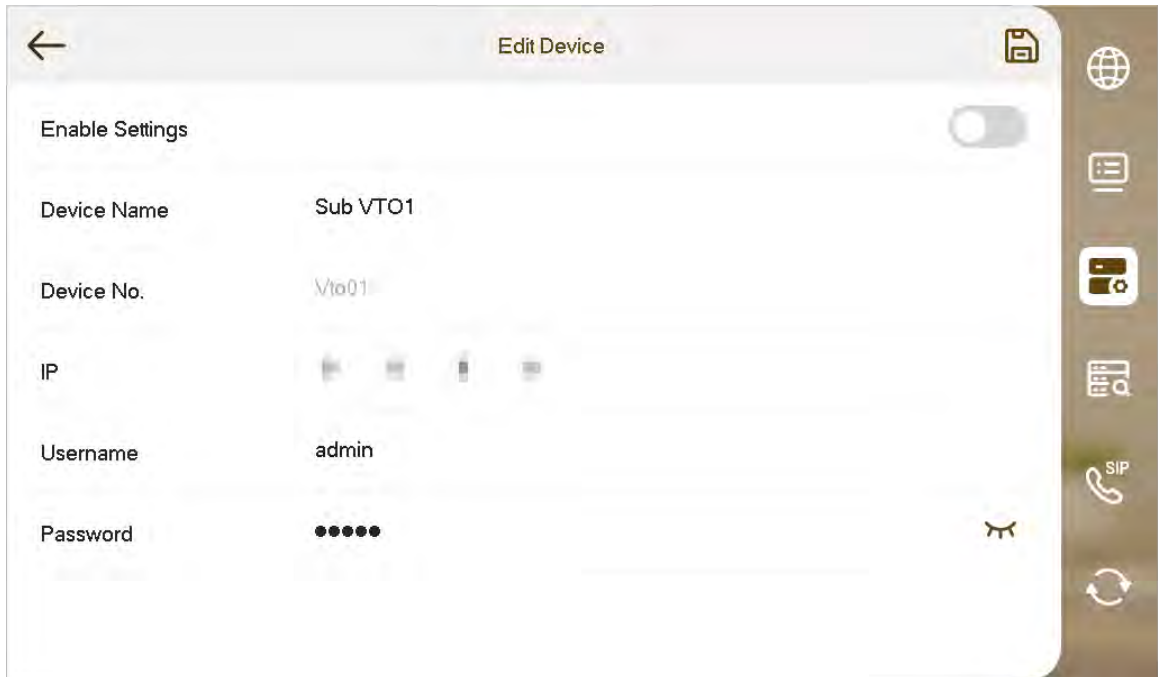

3.7.5 Searching Devices

Procedure



- Step 1 On the main screen, select **Setting** >  > **Project Settings**.
- Step 2 Enter the password, and then tap **OK**.
- Step 3 Tap .
The device searches for the devices in the same network segment.

Figure 3-54 Search devices



3.7.6 Configuring SIP Server

Procedure

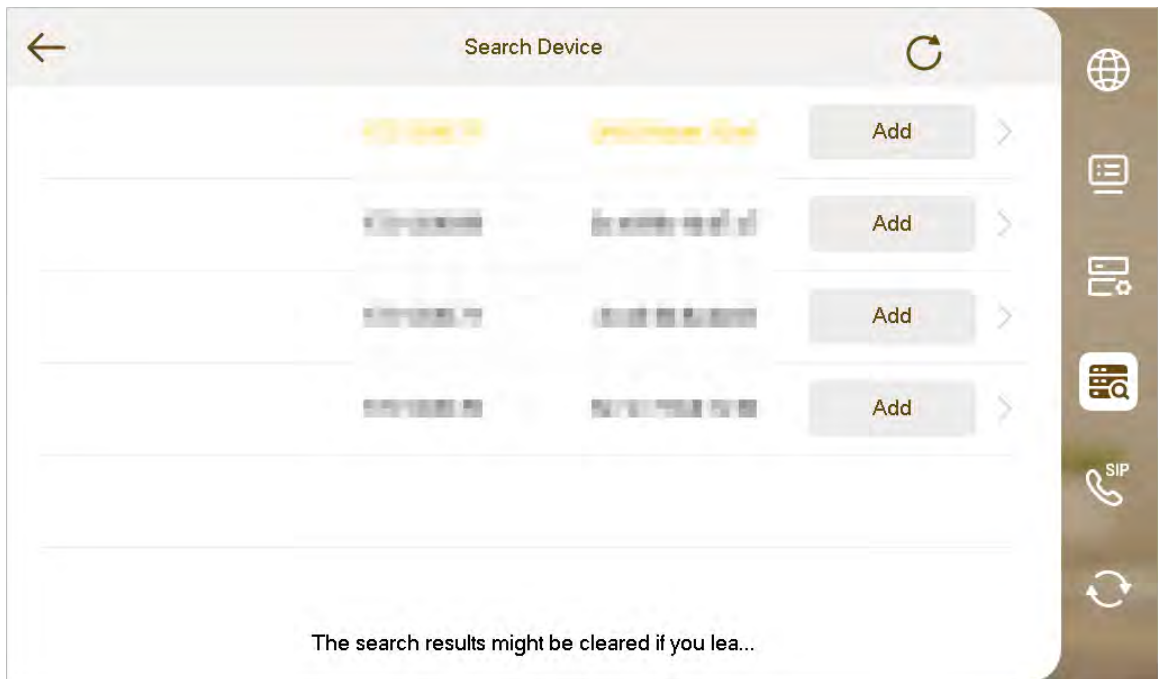

- Step 1 On the main screen, select **Setting** >  > **Project Settings**.
- Step 2 Enter the password, and then tap **OK**.
- Step 3 Tap .

Figure 3-55 SIP server (1)

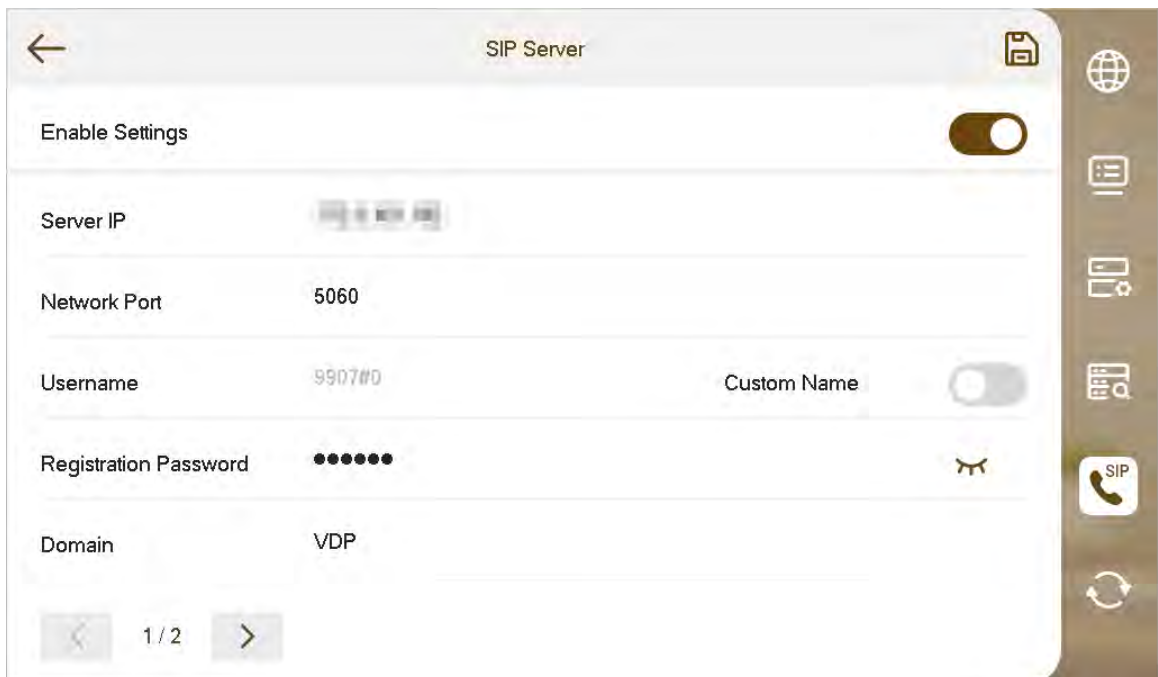

Figure 3-56 SIP server (2)



Step 4 Configure the parameters.

Table 3-13 Description of SIP server parameters

Parameter	Description
Server IP	<ul style="list-style-type: none"> When a platform works as the SIP server, it is the IP address of the platform. When a VTO works as the SIP server, it is the IP address of the VTO.
Network Port	<ul style="list-style-type: none"> 5080 when a platform works as the SIP server. 5060 when a VTO works as the SIP server.
Username	Keep it default, or turn on Custom Name , and then you can edit the username.
Registration Password	Keep it default.
Domain	When a VTO works as the SIP server, it must be VDP; otherwise, it can be null.
Username	SIP server login username and password.
Login Password	

Step 5 Tap next to **Enable Settings** to enable the SIP server function.

Step 6 Tap .

3.7.7 Factory Settings or Reset

All parameters of the device will be restored to default values.



- IP address and data in the SD card will not be restored.
- The SD card is available on select models.

Procedure

Step 1 On the main screen, select **Setting** >  > **Project Settings**.

Step 2 Enter the password, and then tap **OK**.

Step 3 Tap .

Table 3-14 Description of reset parameters

Parameter	Description
Reset Password	Tap  to enable this function. If turned off, you cannot reset the password.
Bound Email	Enter the email address that you want to bind. The email address will obtain the security code during password resetting. For details, see "3.7.1 Forget Password".
Factory Default	Restore the device to its factory settings. All the information on the device will be cleared and the device will restart.

Figure 3-57 Factory settings and reset



3.8 QR Code

Background Information

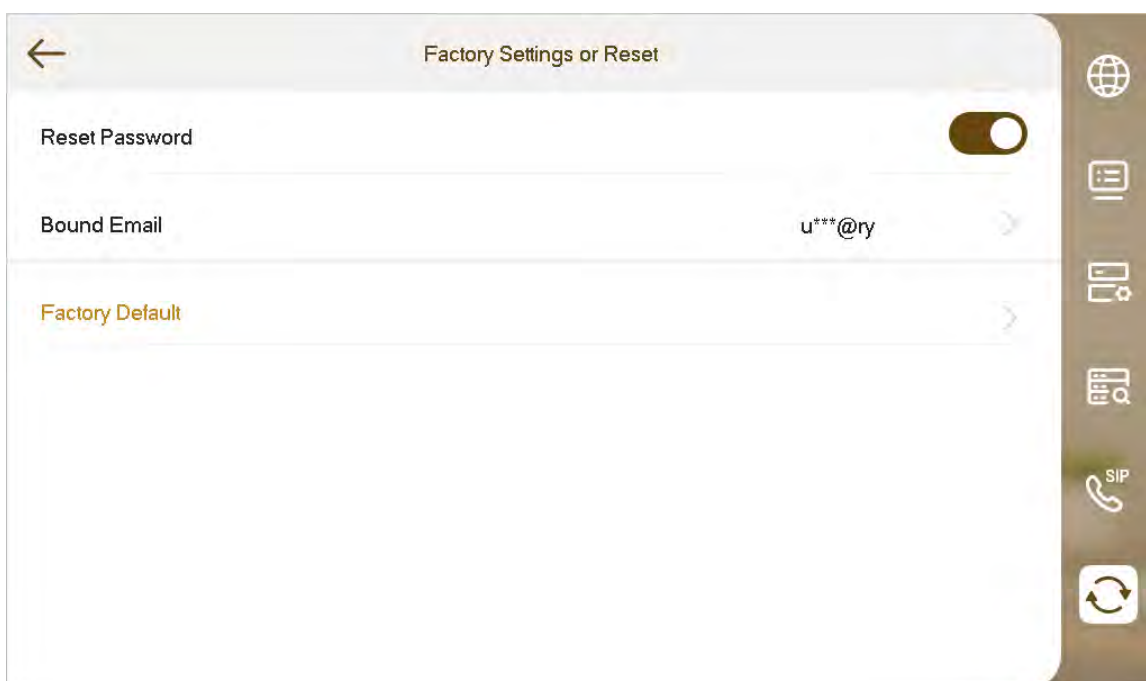
Download the app on your smart phone by scanning the QR code, register the VTH on the app, and then you can unlock the door, or talk to the VTH, and more directly on your smart phone.

Procedure

Step 1 Tap .

If you go to the screen for the first time, there is an onscreen prompt that reminds you to create a DMSS app account before using the DMSS function. For details, see "3.6.6.4.1 Creating Network Password".

Figure 3-58 Onscreen prompt

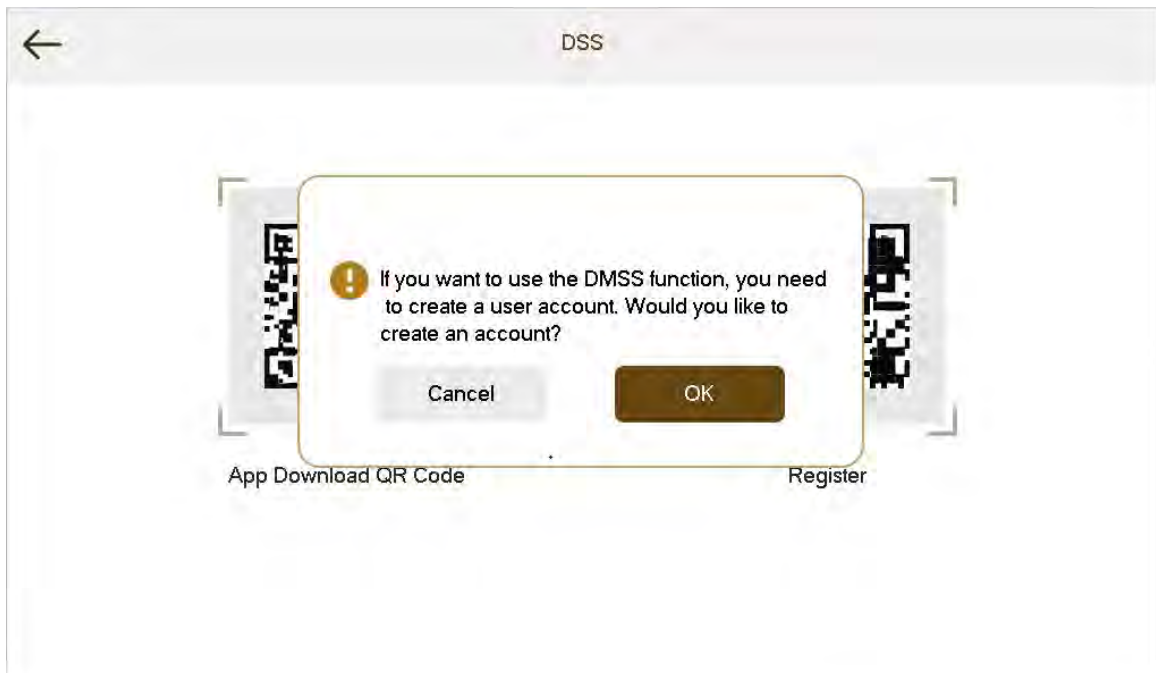

Step 2 After you create a user account, tap **DSS** or **DMSS** tab to view the QR code.

- Scan the **DMSS** QR code on your DMSS app to automatically obtain the VTH information, and gain remote access to the device.
 - Scan the **App Download QR Code** QR code on the **DSS** tab to download the DSS Agile VDP on your smart phone.
 - Scan the **Register** QR code on the **DSS** tab to register the VTH to the DSS Agile VDP.
- For detailed operation of this step, see "4.2 Registration and Login".

Figure 3-59 DSS QR code

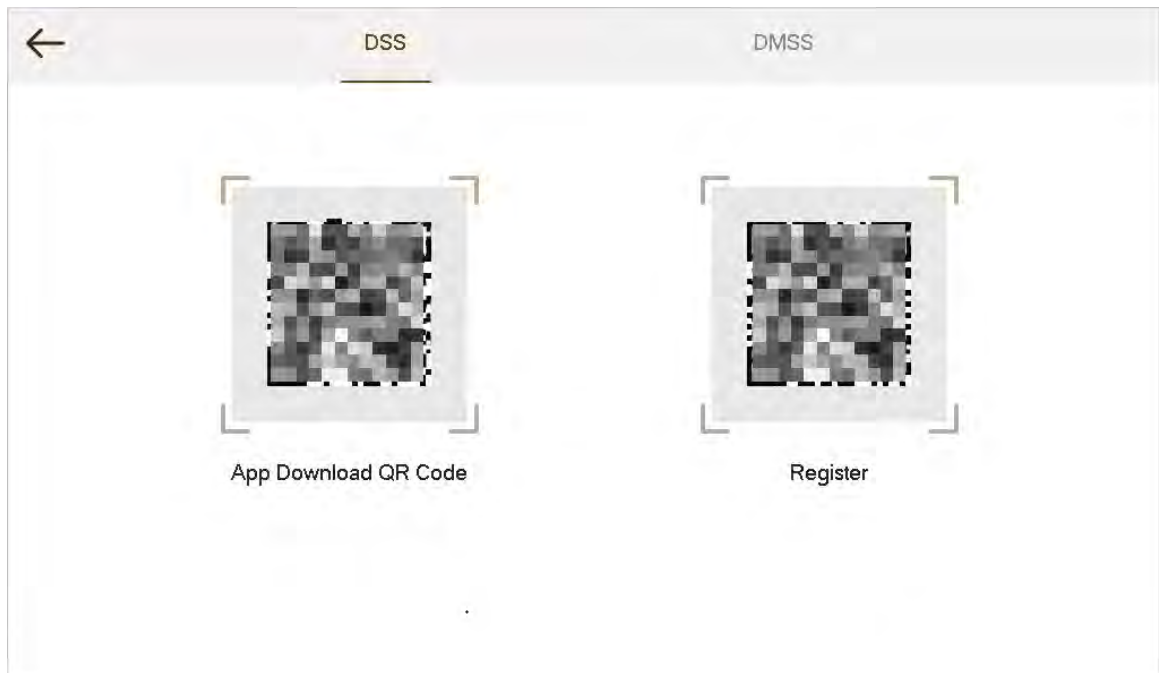
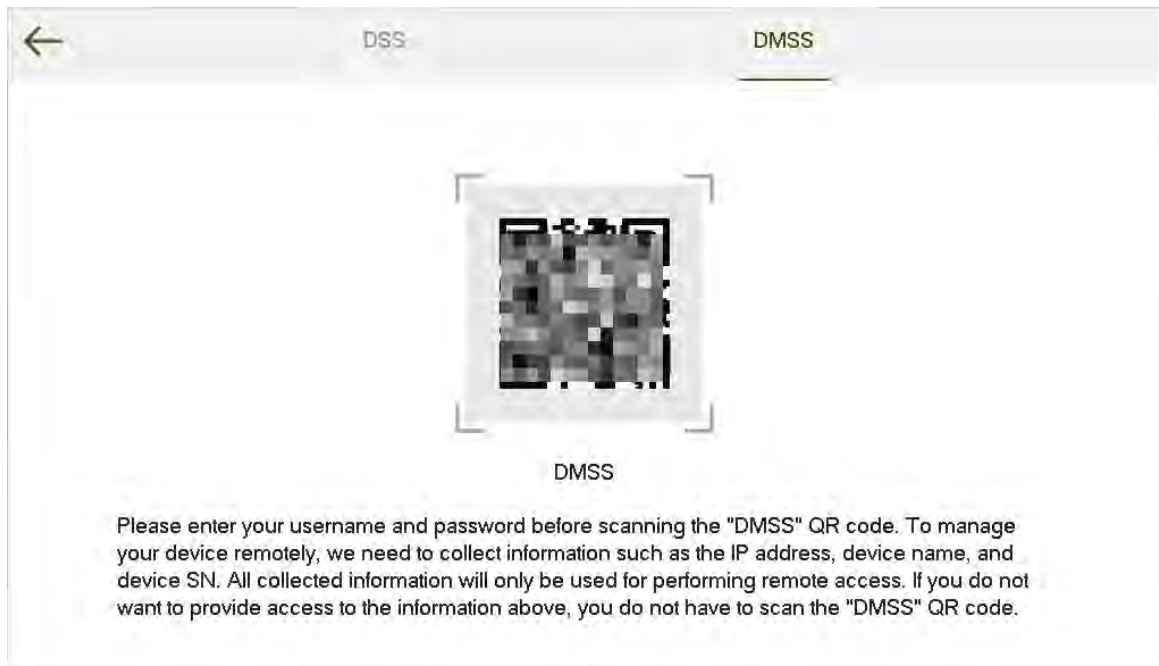

Figure 3-60 DMSS QR code



3.9 Arm and Disarm Function

3.9.1 Arm

After arm, the device produces linkage alarm and uploads alarm info.



- Please ensure that the area has been added into arm mode. Otherwise, there will be no alarm triggering after arm.
- Please ensure that it is in disarmed status. Otherwise, arm will fail.

Procedure

Step 1 Tap  on the home screen to select an arm mode.

- **Home:** An arming mode that allows you to arm the system when inside the area of the alarm system.
- **Away:** Arm the system when you leave the area of the alarm system.
- **Sleep:** An alarming mode that allows you to arm the system in the sleep time.
- **Custom:** Arm the system based on your customized needs.

Figure 3-61 Arm mode

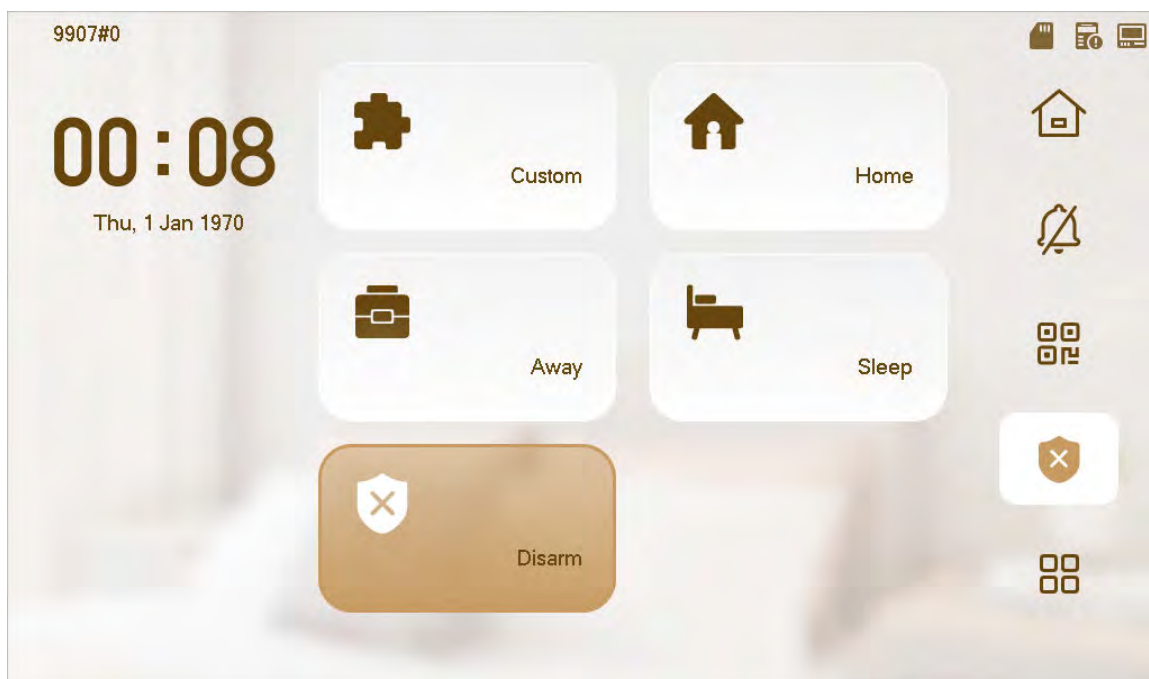

Step 2 Enter arm and disarm password; tap **OK**.





- If you want to modify the password, please refer to "3.6.6.3 User Password Setting" for details.
- If delay alarm is set in the area, the device will beep continuously at the end of exit delay time.

3.9.2 Disarm

Procedure

- Step 1 Tap the arm mode icon on the main screen.
- Step 2 Enter disarm password, and then tap **OK**.
- Default password of arm and disarm is 123456. Please refer to "3.6.6.3 User Password Setting" for details.
 - If you are forced to enter disarm password in case of emergencies, enter anti-hijacking password, which is the reversed arm password. The system will disarm, and at the same time, upload alarm info to management center/platform.

3.10 Property Management

- If you enable **Property Management** when editing the home screen, tap  on the home screen to call management center.
- If you do not enable it, tap  on the home screen, and then tap  to call management center.



Please ensure that management center has been connected. Otherwise, it will fail to call.

3.11 Unlock Function

When the VTH is being called, during monitoring, talking and speaking, tap unlock button, and the VTO will be unlocked remotely.

3.12 Cloud Update

Procedure



- Step 1 Select **Setting** > .
- Step 2 Tap **Cloud Upgrade**.
The current device version is displayed.
- Step 3 Tap  to enable cloud update function.
The device checks for update. After update, the device automatically restarts.

Figure 3-62 Cloud update



4 DSS Agile VDP

You can download DSS Agile VDP (hereinafter referred to as the "app") and link your VTH to the app to unlock the door, talk to connected VTO devices, call the management center, and view call records and messages.

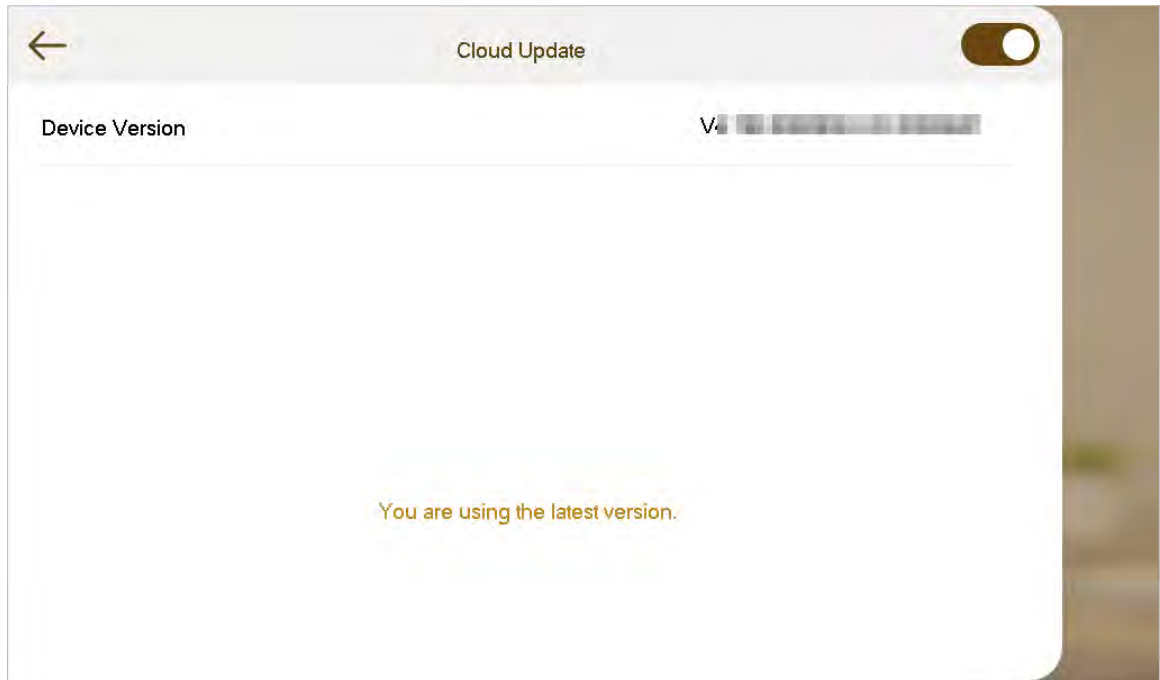

Interfaces and operations might vary between iOS and Android OS. This section takes Android OS as an example.

4.1 Downloading the App

Prerequisites

Before you start, make sure the VTO, VTH, and DSS server are properly connected.

Procedure

Step 1 On the VTH main screen, tap .

Step 2 Scan the **Download App** QR code with your smart phone, and then download and install the app.

Figure 4-1 QR code (without DMSS QR code)

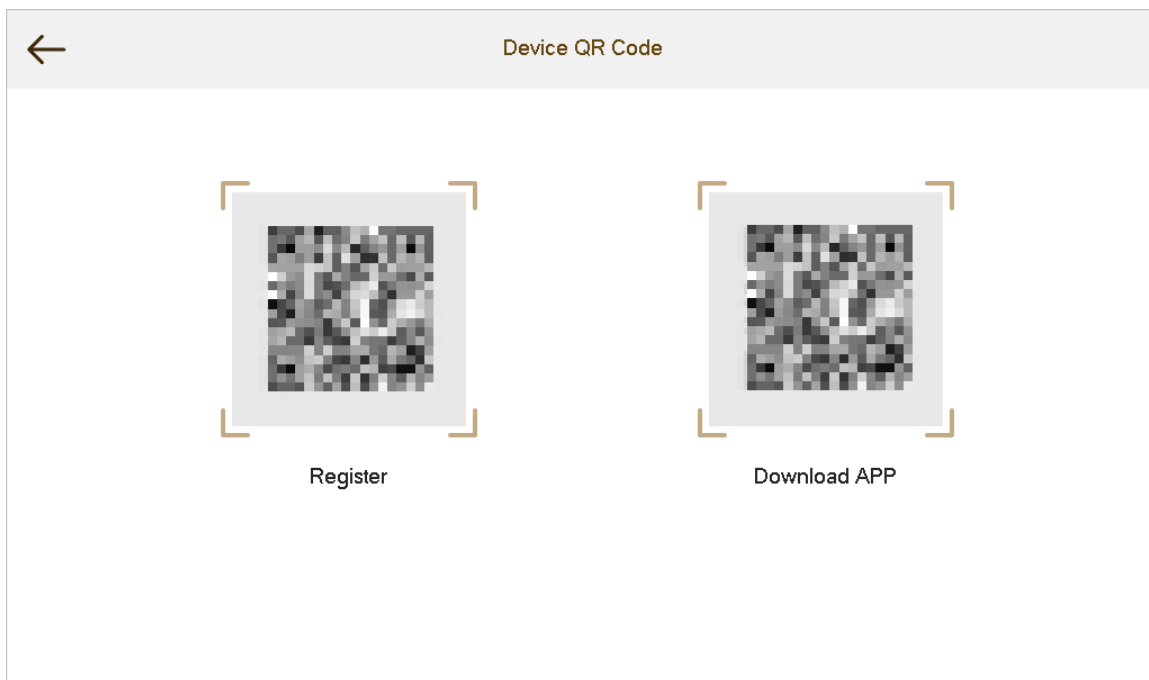

4.2 Registration and Login

Procedure

Step 1 Tap  on your smartphone, read the **Software license agreement and Privacy policy**, and then tap **Agree** (only for first-time login).

Figure 4-2 Registration interface



Step 2 Tap , and then scan the **Register** code on the VTH. See Step 2 in "4.1 Downloading the App"

Figure 4-3 Confirm IP address and port number

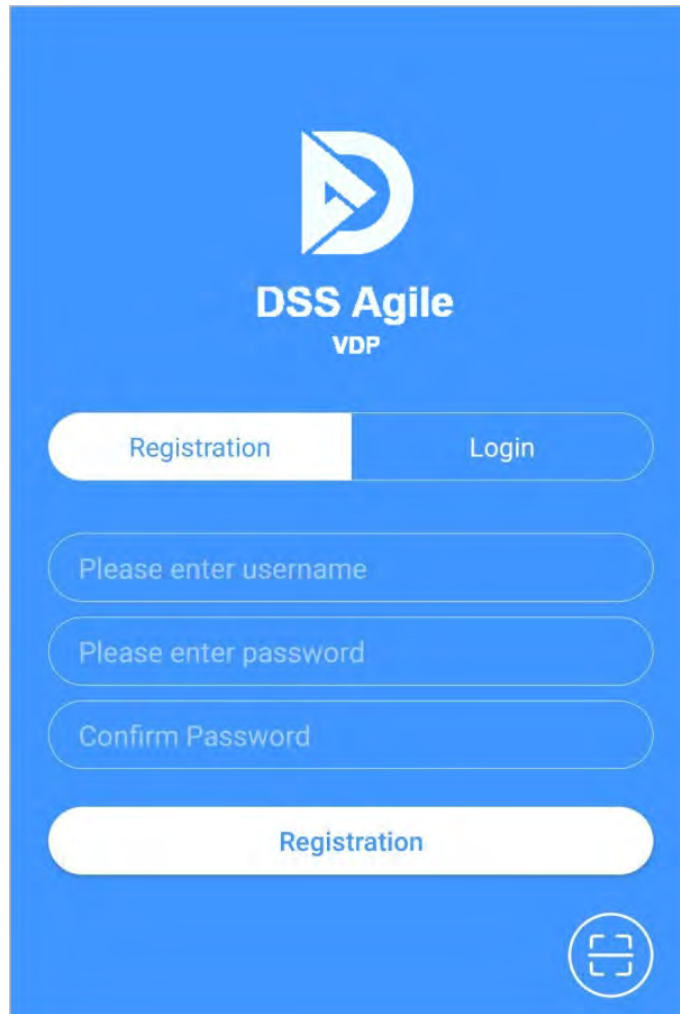

- Step 3 Verify the IP address and port number, and then tap **Confirm**.
- Step 4 Enter the username and password, and then tap **Registration**. You can add 5 users to one VTH at most.

Figure 4-4 Login

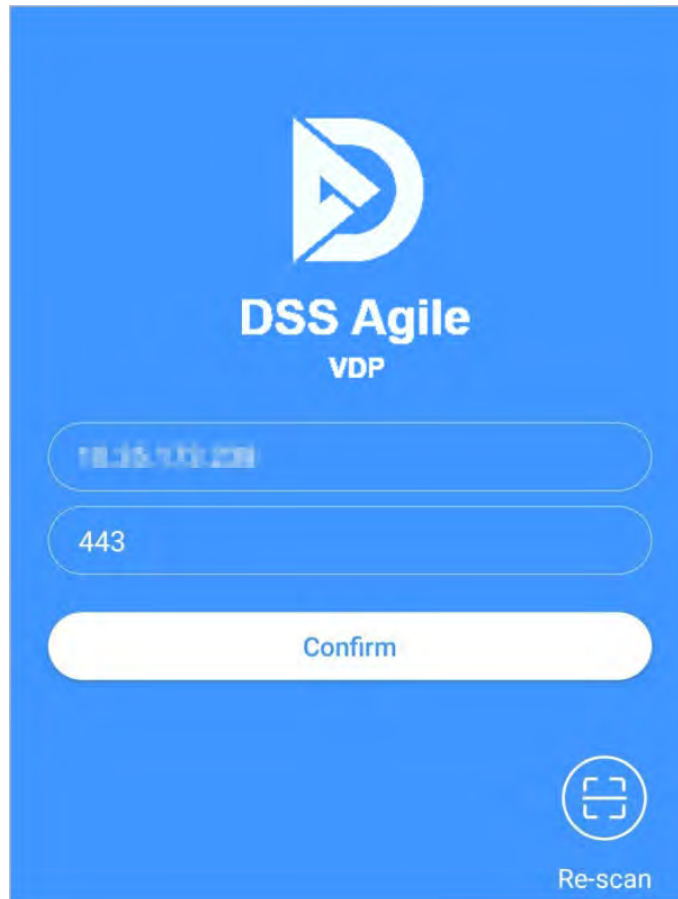
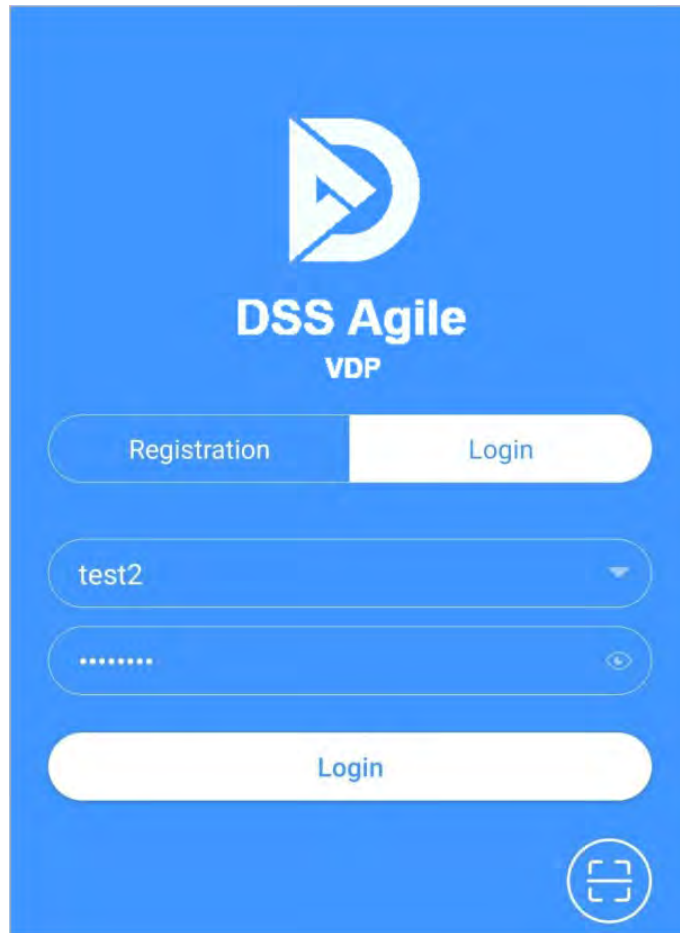

Step 5 Tap the **Login** , enter the username and password you have set, and then tap **Login**.

4.3 Call Functions

You can receive the forwarded calls, remotely unlock the door, view live video of the VTO, and more.



To receive push notifications of call messages on the mobile phone, make sure that notifications of the app are enabled on your smart phone, and you are logged in to the app.

4.3.1 Forwarding Calls

Confirm your SIP ID, and then configure call forwarding on the VTH. If any device calls the VTH, you will receive the call on your smartphone.

Procedure

Step 1 Log in to the app, and then tap **Setting**.

In the following example, the **SIP ID** is **1#1#8001#179**.

Figure 4-5 Settings

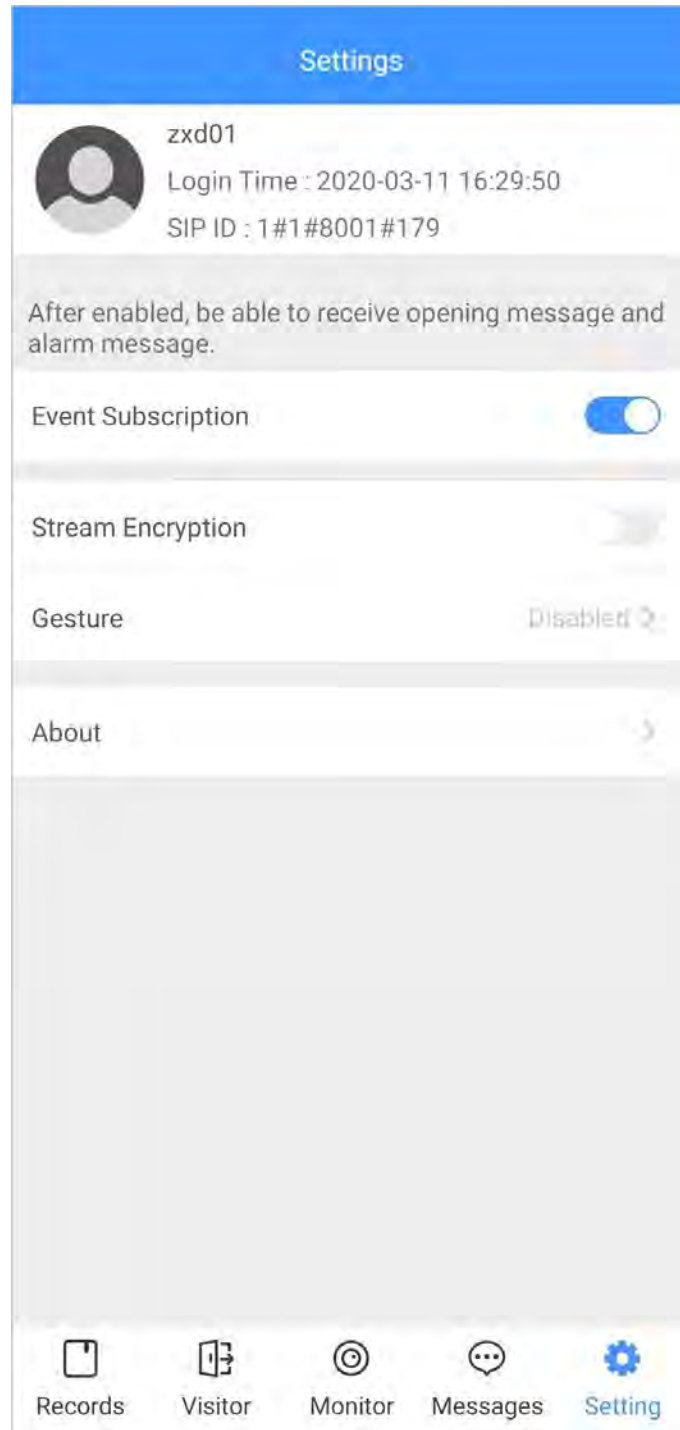

Step 2 On the VTH main screen, tap **Setting**.

Step 3 Enter the password you configured, and then tap **Forward**.

Select forwarding type as needed:

- **Always Forward** : All calls to this VTH will be forwarded.
- **Forward when Busy** : If the VTH is busy, the call will be forwarded.
- **Forward when Not Answered** : Any call that is not answered within the defined ring time will be forwarded. See "3.6.1.4 Other Ring Settings" for details.

Figure 4-6 Call forwarding

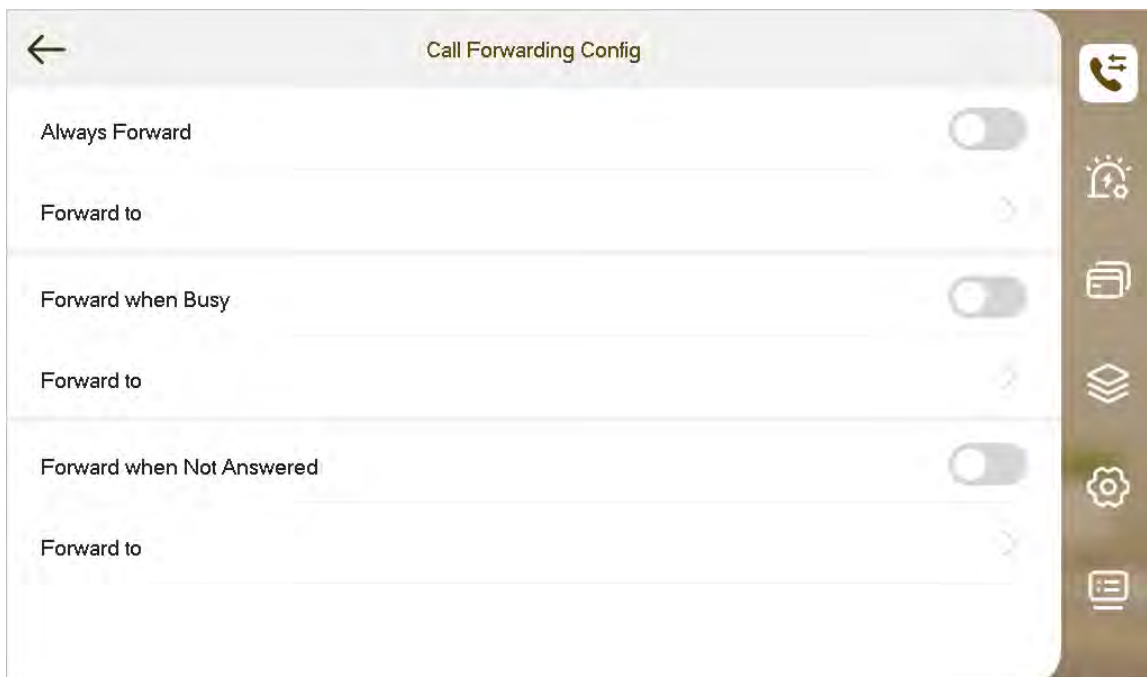

Step 4 Enter the SIP ID in the input box.

- Forward calls to a specific user: Enter the SIP ID of the user. For example, enter 1#1#8001#179 from Figure 4-5 , and then calls will be forwarded to this user.
- Forward calls to every user: Change the last three numbers of the SIP ID to 100 (1#1#8001#100), and then all users linked to this VTH will receive the call on their smart phones at the same time.

Step 5 Tap to enable the forwarding type you selected, and then tap **OK**.

4.3.2 Calling Operations

After call forwarding is configured, you can receive and answer phone calls from the VTO or the management center.

For example, when a VTO is calling, you can answer the call, view live video, and remotely unlock the door if the VTO is connected to a lock.

Figure 4-7 A call from a VTO

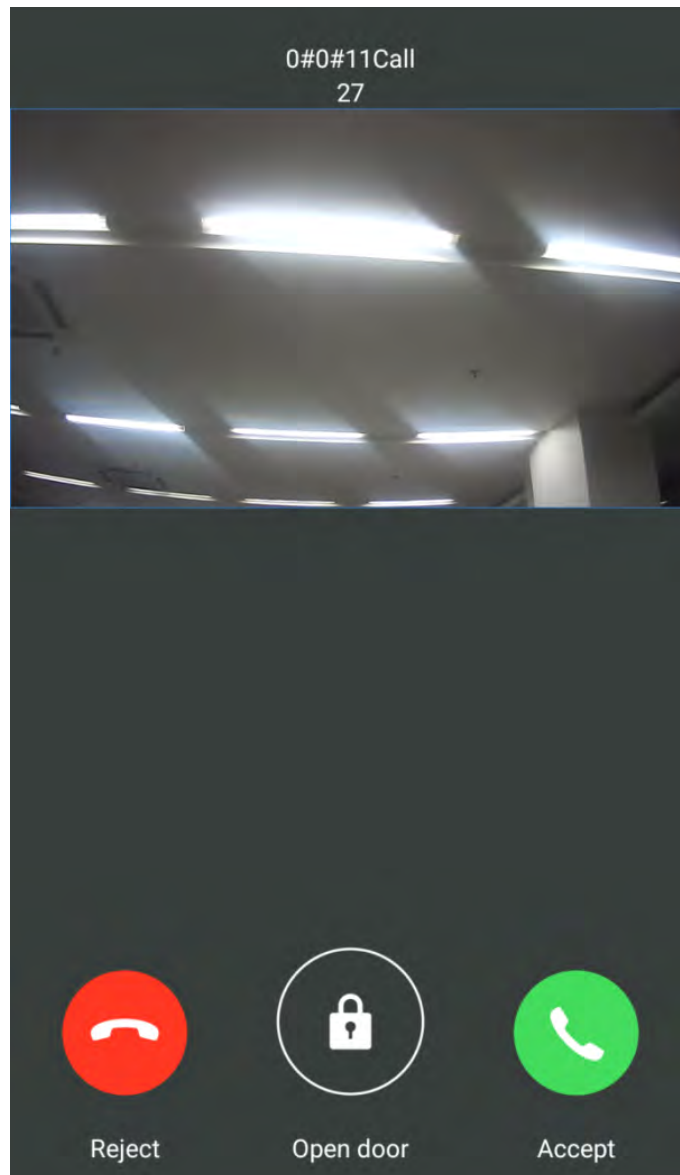

4.4 Monitoring

Background Information

After a VTO is added, you can view its live video, have two-way audio talk, call management center, and remotely unlock the door.

Procedure

Step 1 Log in to the app, and then tap **Monitor**.

Figure 4-8 Monitor screen

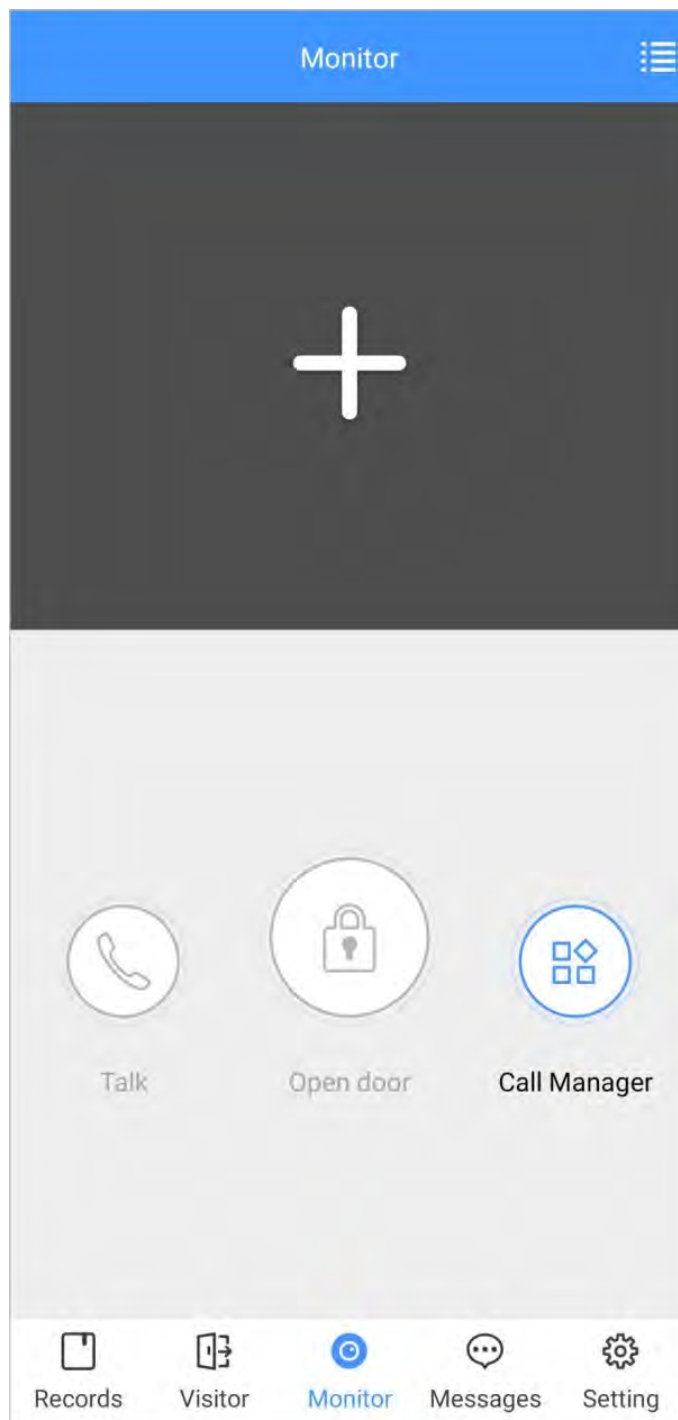





Step 2 Tap , select the VTO from the channel list as needed.

Figure 4-9 Live video

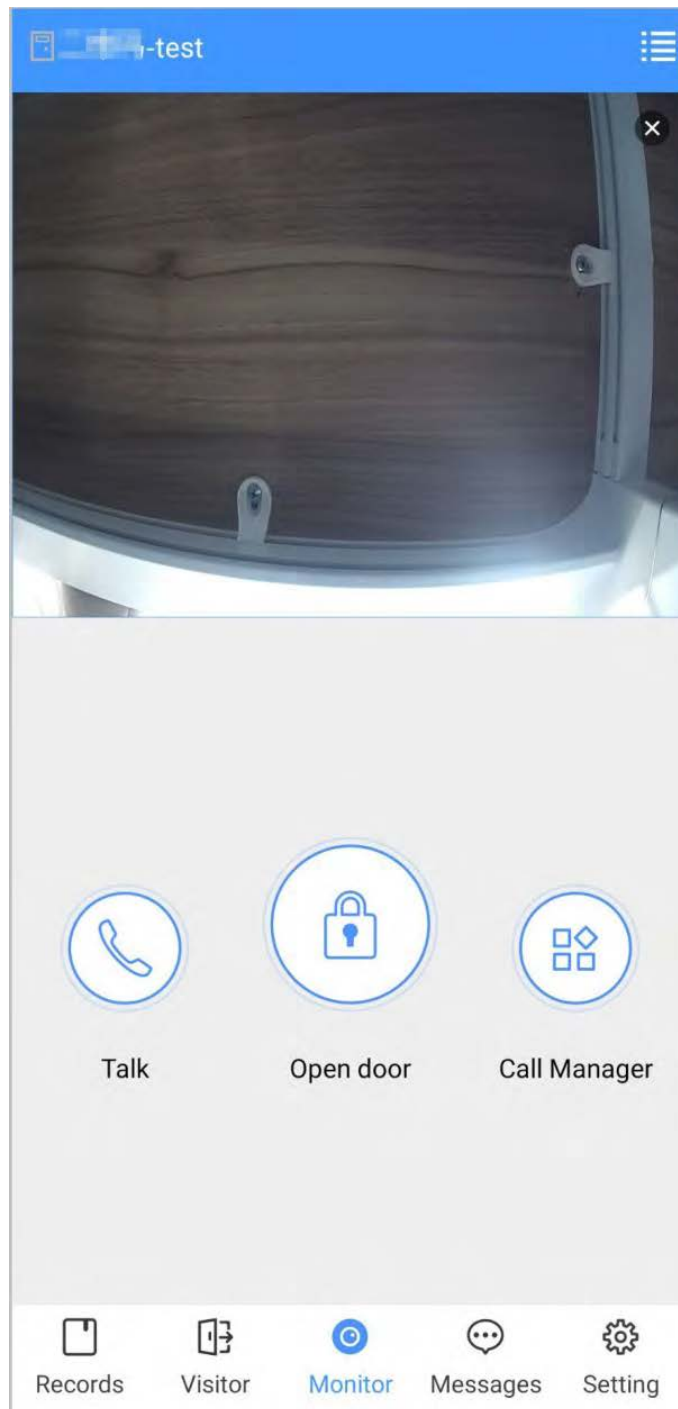

- : Switch to another VTO.
- : Unlock the door remotely.
- : Have a two-way audio talk with the VTO.
- : Call management center.

4.5 Call Records

View the incoming and outgoing call records.

Log in to the APP, and then tap **Records**.

Figure 4-10 Call records

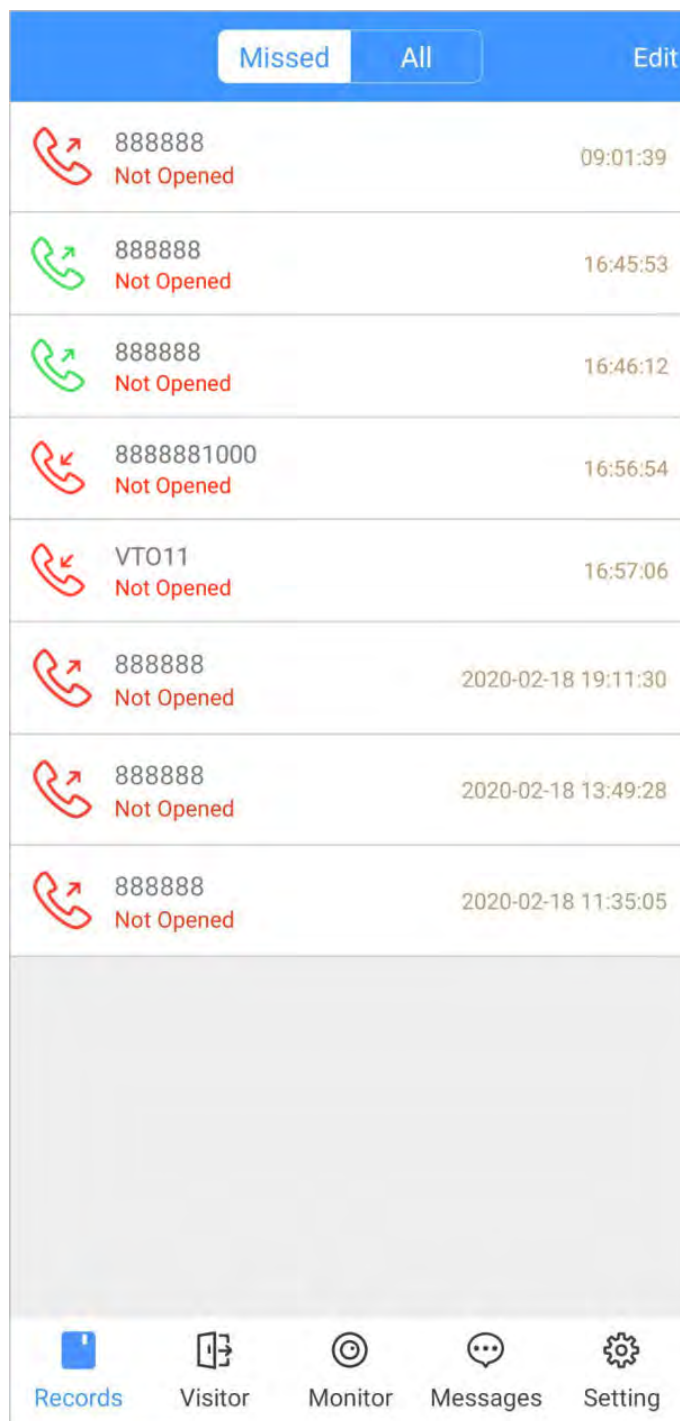

The screenshot shows a mobile application interface for call records. At the top, there is a blue header with two tabs: 'Missed' (selected) and 'All'. To the right of the tabs is an 'Edit' button. Below the header is a list of call records. Each record consists of a phone icon (red for missed, green for answered), a phone number, the status 'Not Opened', and a timestamp. The records are as follows:

Icon	Number	Status	Time
Red	888888	Not Opened	09:01:39
Green	888888	Not Opened	16:45:53
Green	888888	Not Opened	16:46:12
Red	8888881000	Not Opened	16:56:54
Red	VTO11	Not Opened	16:57:06
Red	888888	Not Opened	2020-02-18 19:11:30
Red	888888	Not Opened	2020-02-18 13:49:28
Red	888888	Not Opened	2020-02-18 11:35:05

At the bottom of the screen is a navigation bar with five icons and their corresponding labels: 'Records' (blue square), 'Visitor' (door icon), 'Monitor' (target icon), 'Messages' (speech bubble icon), and 'Setting' (gear icon).

- Red phone icon: The call is missed or not answered.
- Green phone icon: The call is answered.
- **Not Opened/Opened** : Indicates whether the door is unlocked.
- **Edit** : Delete the record one by one, or tap **Edit** > **Empty** to delete all records.

4.6 Message

You can view the unlocking records and alarm messages, and search for history messages.

- You need to enable **Event Subscription** in **Setting** of the App first.
- To receive messages on your smart phone, make sure that notifications of the app are enabled on your smart phone and the you are logged in to the app.

Viewing Messages

- Log in to the app, tap **Messages** > **Access**, and then you can view unlocking records, such as unlocking method, which user unlocked the door, and when the door is unlocked.

Figure 4-11 Access messages

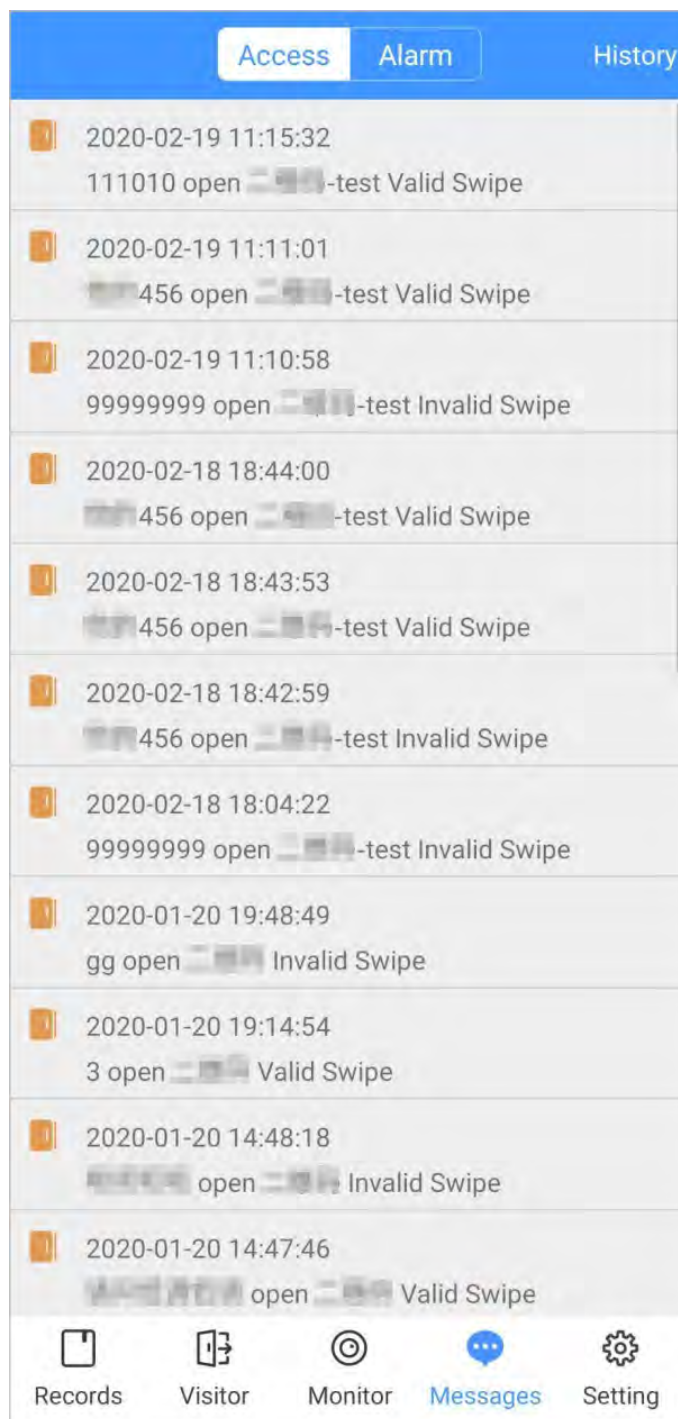

- Log in to the App, tap **Messages** > **Alarm**, and then you can view alarm messages.

Figure 4-12 Alarm messages

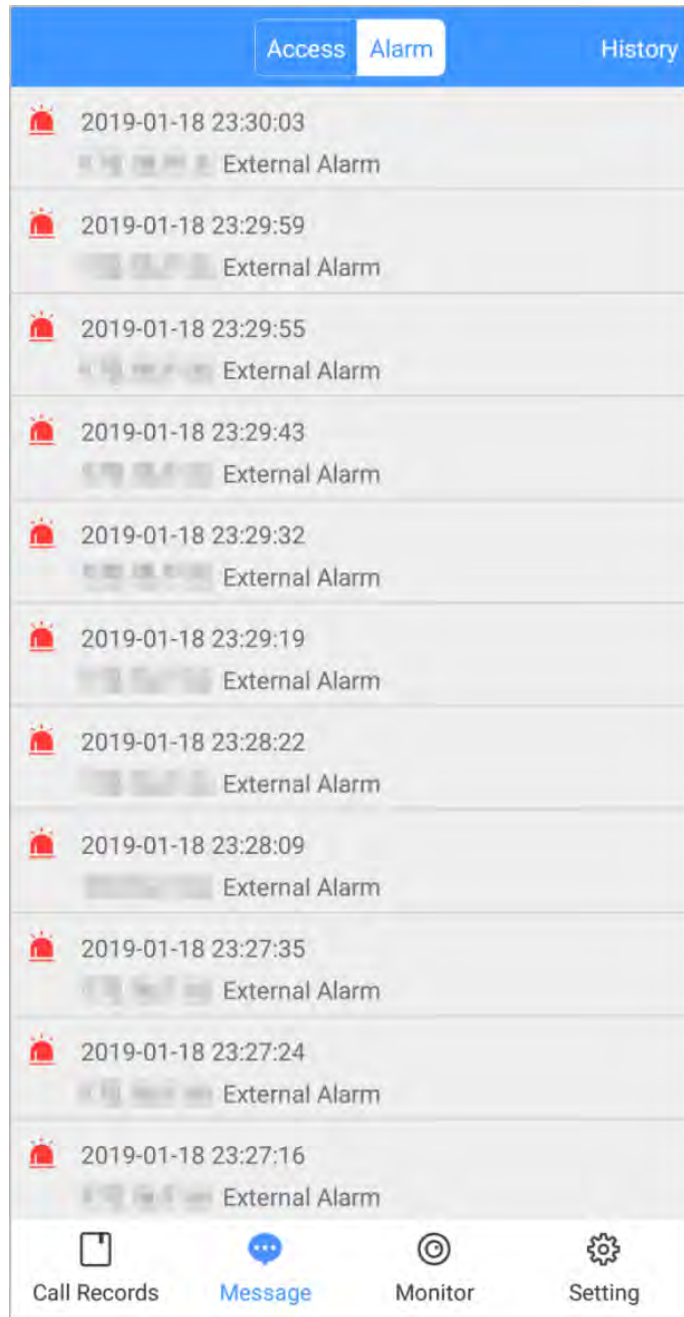

Searching for History Messages

Tap **History**, set the start and end time, and then tap **SEARCH**.

You search for messages within up to 7 days.

Figure 4-13 History messages

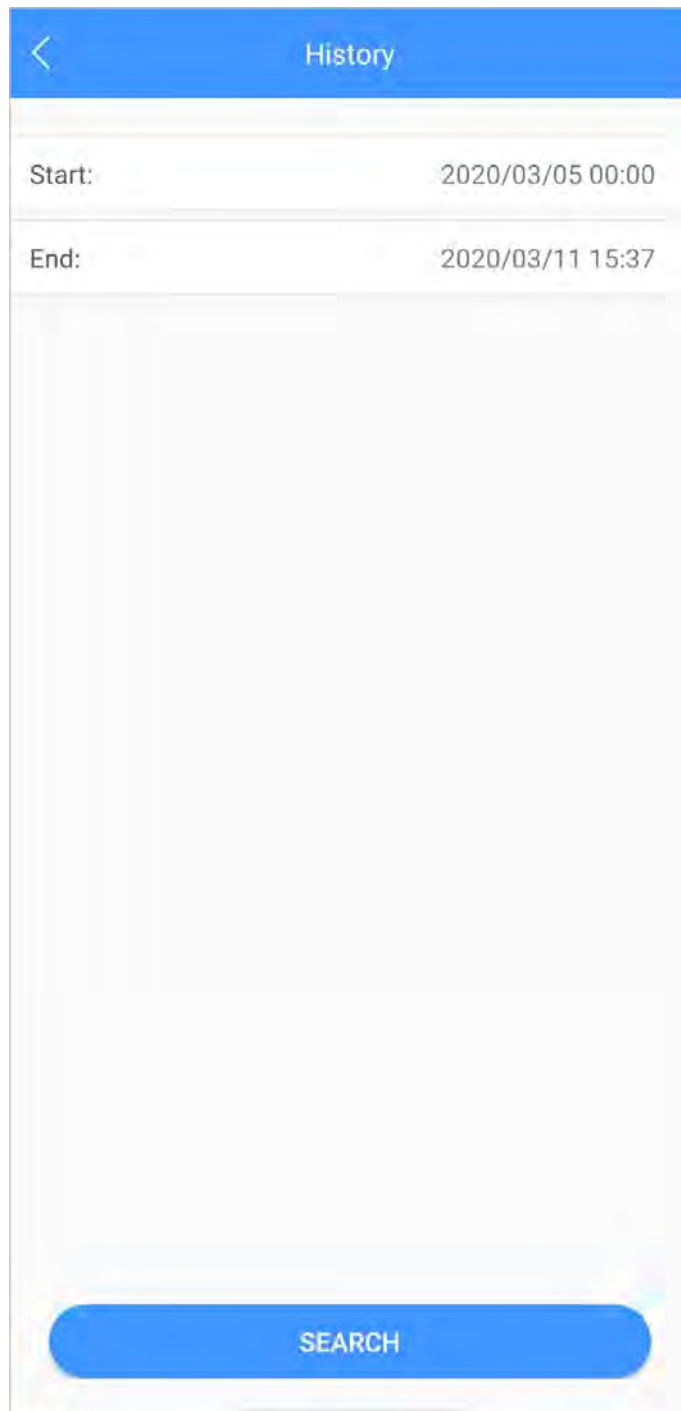

4.7 Visitor

You can create a pass for a visitor to have access permission. The pass is invalid after it is manually invalidated, the visiting period expires, or the visit is ended. You can also view visit records.

4.7.1 Creating Pass

Procedure

Step 1 Log in to the APP, and then tap **Visitor**.

Figure 4-14 Visitor information

The screenshot shows a mobile application interface for creating a visitor pass. At the top, there are two tabs: 'Pass' (selected) and 'Record'. Below the tabs, the form is organized as follows:

- Resident:** 3#1#2002#101
- Visitor:** Mike
- Vehicle:** 12345678 (with a toggle switch on the right)
- Phone No.:** 88888888
- Visit Time:** 2020-03-11 15:14:43 and 2020-03-12 15:14:43
- Credential:** ID Card (with a 'Select >' dropdown arrow)
- Credential No.:** [Redacted]
- Remark:** VIF

A large blue button labeled 'Generate Pass' is positioned at the bottom of the form area. Below the form is a bottom navigation bar with five icons and labels: 'Records', 'Visitor' (highlighted in blue), 'Monitor', 'Messages', and 'Setting'.

Step 2 Enter the information of the visitor, and then tap **Generate Pass**.



Each visitor can only register one plate number.

Figure 4-15 Visitor pass

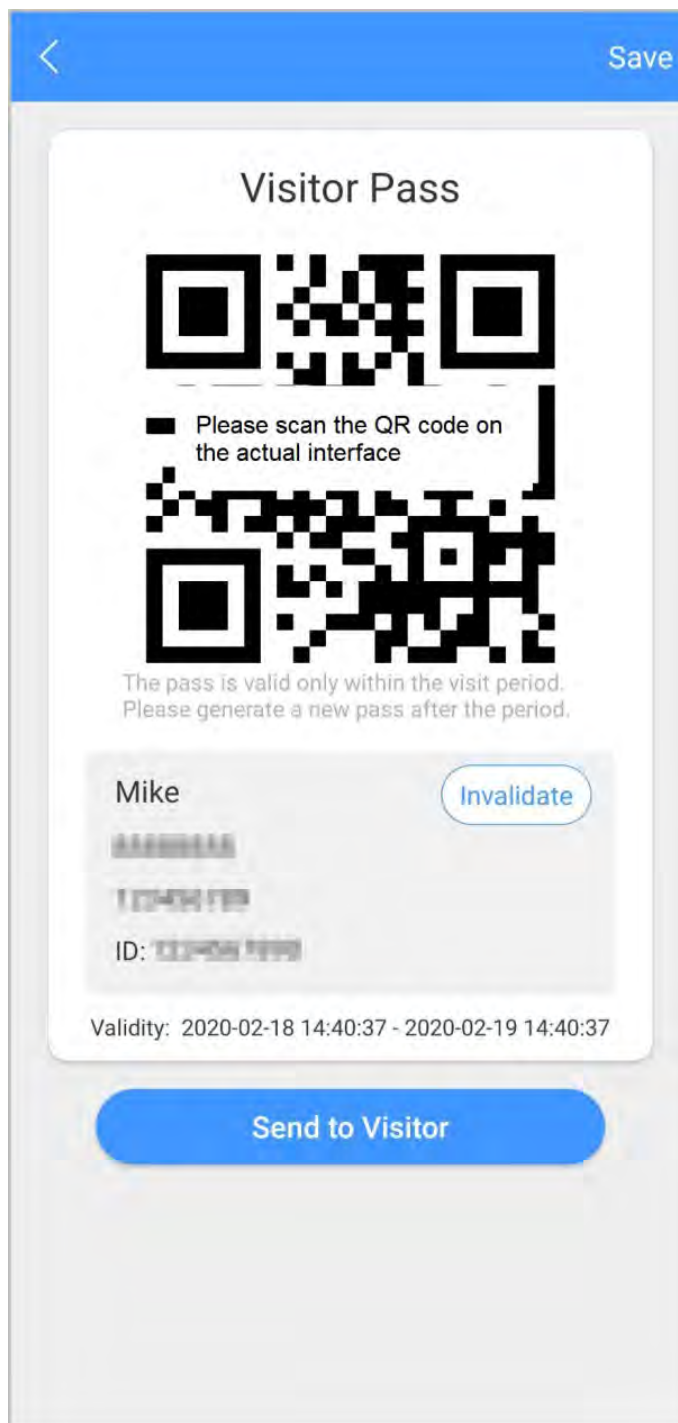

Step 3 Tap **Send to Visitor** to send the QR code to the visitor.



Tap **Save** to save the QR code to your smartphone.

Step 4 (Optional) Tap **Invalidate** to cancel the appointment, and then the QR code will not have access permissions.



Tap **Invite Again** to generate a new pass for the visitor.

Figure 4-16 Invalidate the pass



4.7.2 Visit Records

You can view visitor status such as having an appointment, on a visit, ending the visit, and cancelling the appointment. You can also view and modify the pass.

- View visitor status: Log in to the APP, tap **Visitor** > **Record**.
- View and modify a pass: Tap a visitor in the list, and then you can view detailed information of the pass, invalidate the appointment, invite the visitor again, and more. For details, see "4.7.1 Creating Pass".

Figure 4-17 Visitor records

Pass	Record	
Mike	2020-02-18 16:01:57	Cancel Appointment >
Mike	2020-02-18 15:59:01	Cancel Appointment >
TOM	2020-02-18 15:58:45	Appointment >
TOM	2020-02-18 15:46:54	Cancel Appointment >
TOM	2020-02-18 15:46:43	Cancel Appointment >
TOM	2020-02-18 15:46:11	Cancel Appointment >
Mike	2020-02-18 15:36:32	Appointment >
Mike	2020-02-18 15:34:37	Cancel Appointment >
w1	2020-01-20 09:19:44	Cancel Appointment >
rft2	2020-01-20 09:01:24	End Visit >
rft	2020-01-20 08:58:53	End Visit >

Records Visitor Monitor Messages Setting

4.8 Setting

You can view SIP ID, and enable message subscription, stream encryption, message sound, login by pattern, and more.

Log in to the app, and then tap **Setting**.

Figure 4-18 Setting

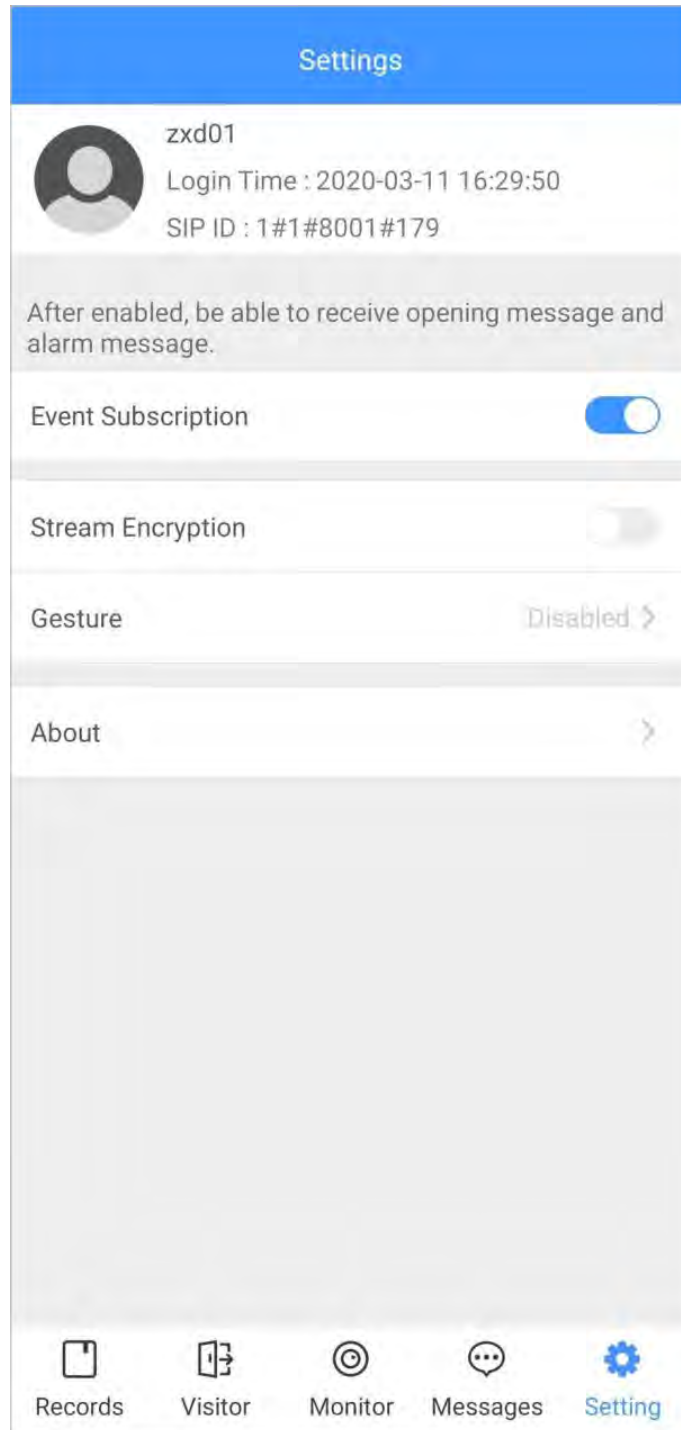

- **Event Subscription** : Enable it, and then you can receive unlocking messages and alarm messages. See "4.6 Message"for details.
- **Stream Encryption** : Enable it to enhance security, but stream acquisition speed might slow down.
- **Gesture** : Draw a pattern, and then you can log in by that pattern.
- **About** : View app version, software license and privacy policy, help document, or log out of the current account.

5 DMSS App

You can download DMSS App and link your VTH to the app to unlock the door, talk to connected VTO devices, call the management center, and view call records and messages.

5.1 Downloading DMSS

- iOS users: Search for DMSS in the App store, and then download the App.
- Android users: Search for DMSS in Google Play to download the App.

5.2 Registration and Login

Procedure

Step 1 On your phone, tap  to open the app.

Figure 5-1 Login



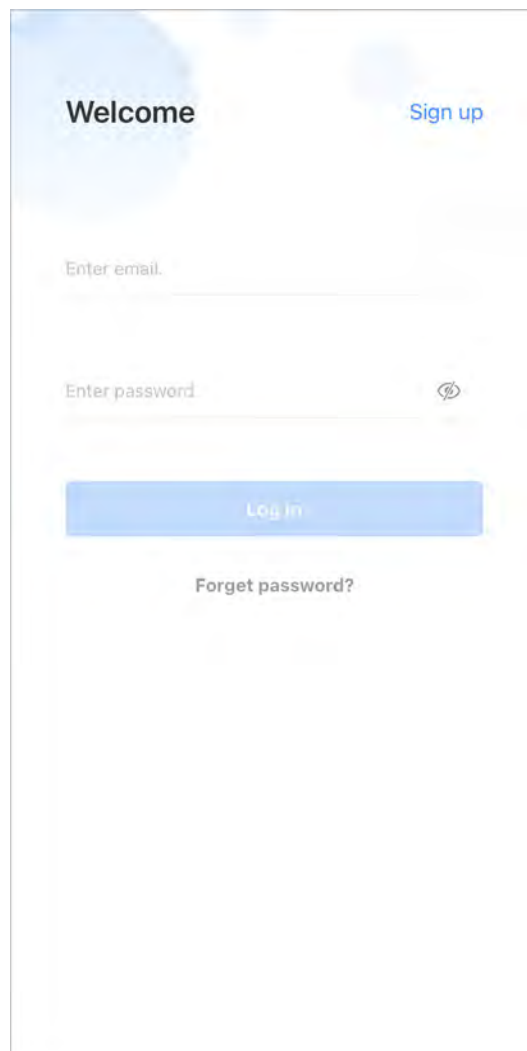

Step 2 Create an account.
1. On the **Login** screen, tap **Sign up**.

Figure 5-2 Sign up

2. Enter your email address and password.



Tap  to show the password, and the icon will become .

3. Read the **User Agreement** and **Privacy Policy**, and then select the **I have read and agree to** checkbox.
4. Tap **Get verification code**, check your email box for the verification code, and then enter the code.



Use the verification code within 60 seconds of receiving it. Otherwise, the verification code will become invalid.

Figure 5-3 Enter verification code

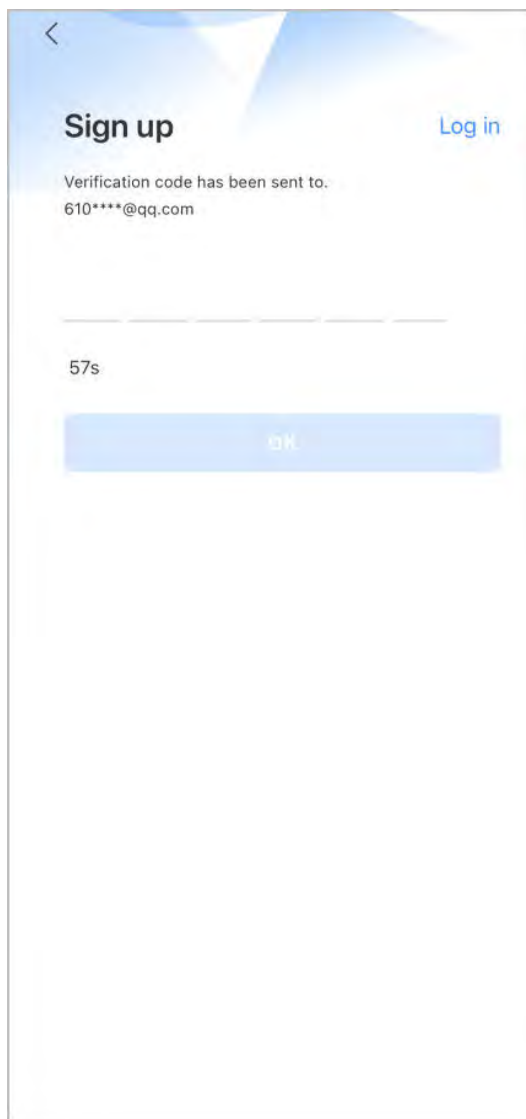

5. Tap **OK**.

Step 3 On the **Login** screen, enter your email and password, and then tap **Log in**.





You can modify the password on the **Me > Account Management > Modify Password**.

5.3 Adding VTH to DMSS

Procedure

Step 1 Power on the VTH.

Step 2 On the **Home** screen of the app, tap , and then select **SN/Scan**.

Step 3 Scan the QR code at the rear panel of the VTH to obtain the information of the VTH or scan the DMSS QR code by tapping  on the VTH home screen to obtain the device information of the VTH.



When going to the QR Code screen for the first time, the **DMSS** QR code would not appear. Only after you set the network password, this module would be displayed. For the detailed operation, see "3.6.6.4 Network Password Setting".

Figure 5-4 Add VTH

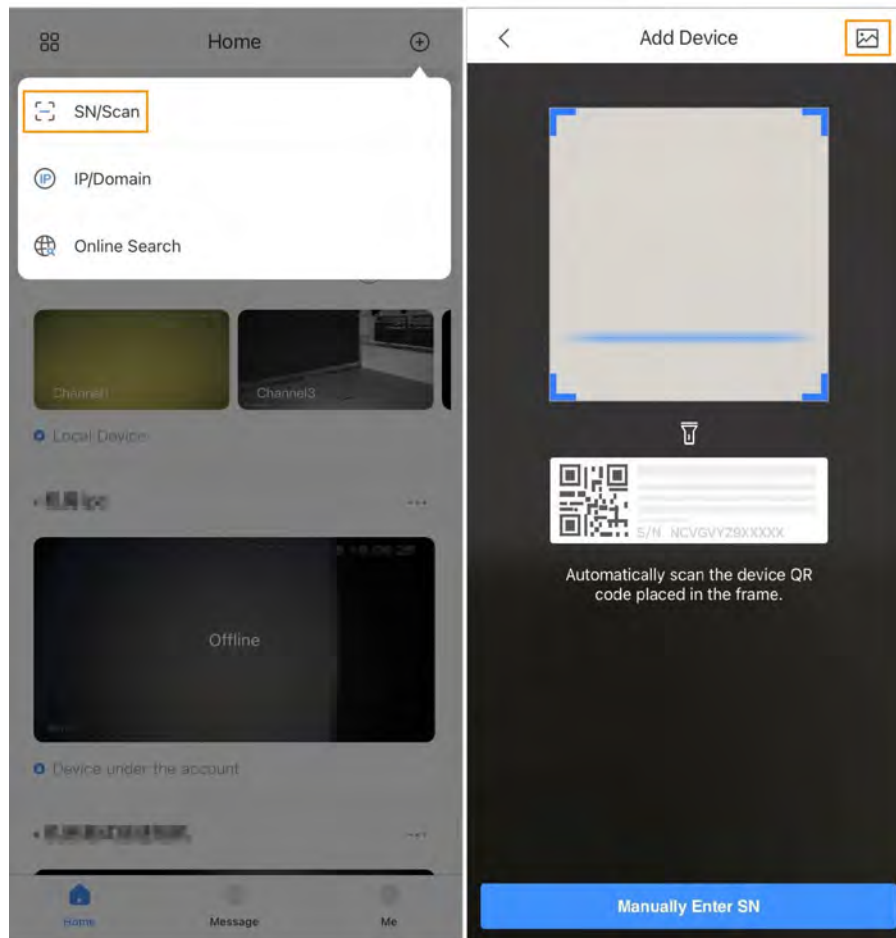
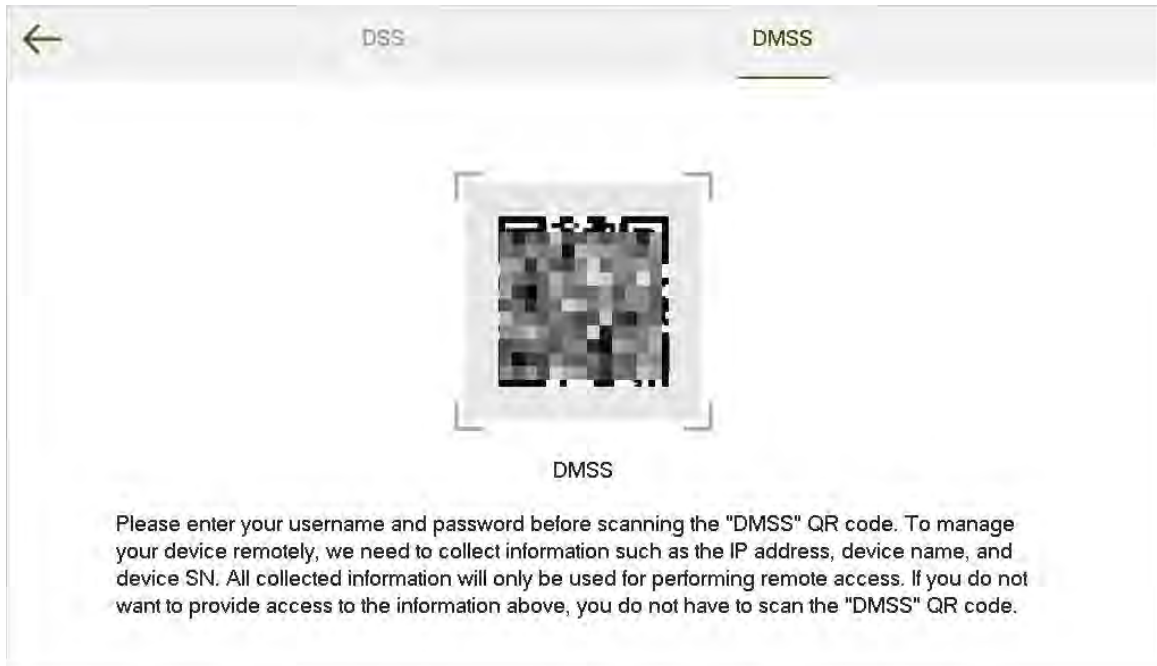

Figure 5-5 DMSS QR code



Step 4 On the **Add Device** screen, enter the device name of the VTH, username and password of the VTH, and then tap **Save**.

- **Device Name** : customized.
- **Username** : Enter **user**.
- **Password** : Enter the network password of the VTH you configured in "3.6.6.4.1 Creating Network Password".

Figure 5-6 Add device



Step 5 Configure the time zone, and then tap **Done**.

You have completed the device adding steps.

5.4 Configuring Arm and Disarm

Make sure that the VTH and VTO are properly connected.

Procedure

Step 1 On the **Home** screen, tap , select the VTH you have just added, and then tap **Device Details** to go to the function screen.

Step 2 Tap **Disarm** or **Arm** to disarm or arm the VTH.

Figure 5-7 Disarm VTO

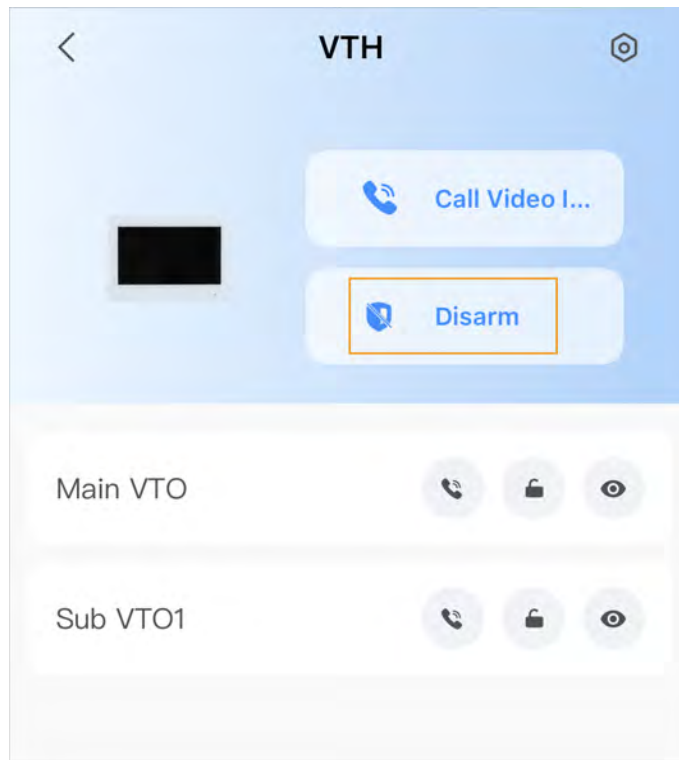

Step 3 Select from the arm/disarm mode list, and the arm/disarm configuration would take effect on the VTH after you completed the setting.

- **Sleep:** An alarming mode that allows you to arm the system in the sleep time.
- **Home Mode:** An arming mode that allows you to arm the system when inside the area of the alarm system.
- **Always Mode:** Arm the system when you leave the area of the alarm system.
- **Custom Arming:** Arm the system based on your customized needs.
- **Disarm:** Turn the security system off. The opposite of arming.

Figure 5-8 Arm and disarm mode

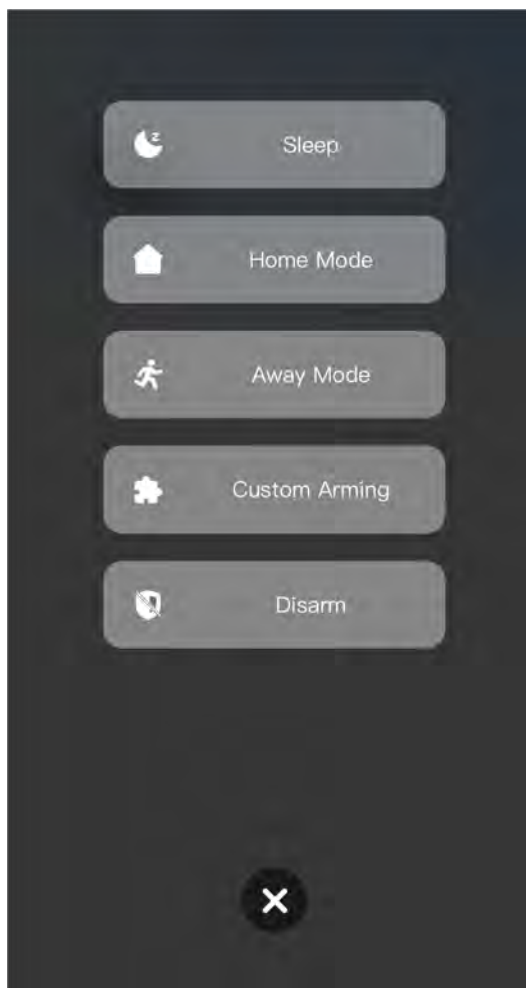

5.5 DMSS Calling VTH

Make sure that the VTH and VTO are properly connected.

Procedure



- Step 1 On the **Home** screen, tap , select the VTH you have just added, and then tap **Device Details** to go to the function screen.
- Step 2 Tap **Call Video Intercom** to call the VTH you added to the DMSS.

Figure 5-9 Call VTH

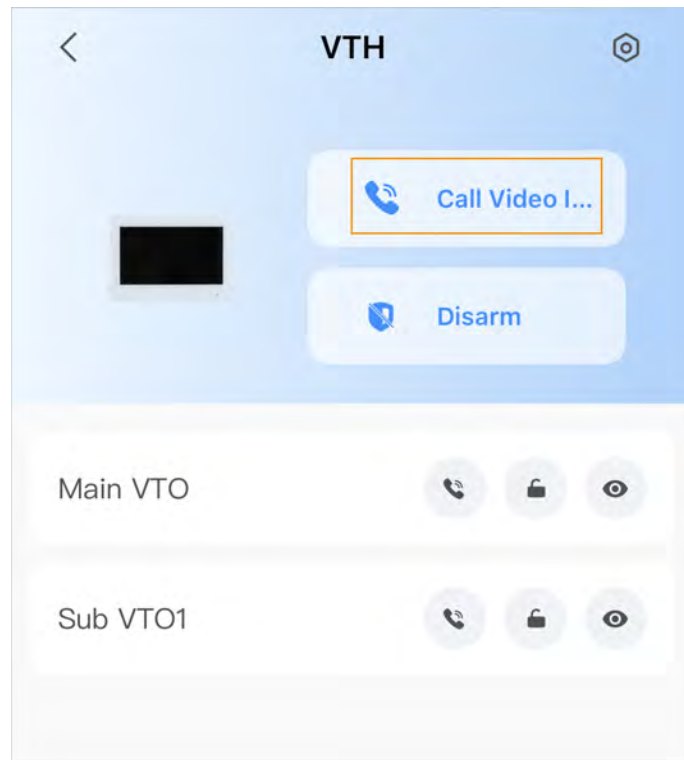

5.6 DMSS Calling VTO

Procedure

Step 1 On the **Home** screen, tap , select the VTH you have just added, and then tap **Device Details** to go to the function screen.

Step 2 Tap  to call the VTO you added to the DMSS.



If there are more than one VTO, you can call the main VTO and sub VTO respectively.

Figure 5-10 Call VTO

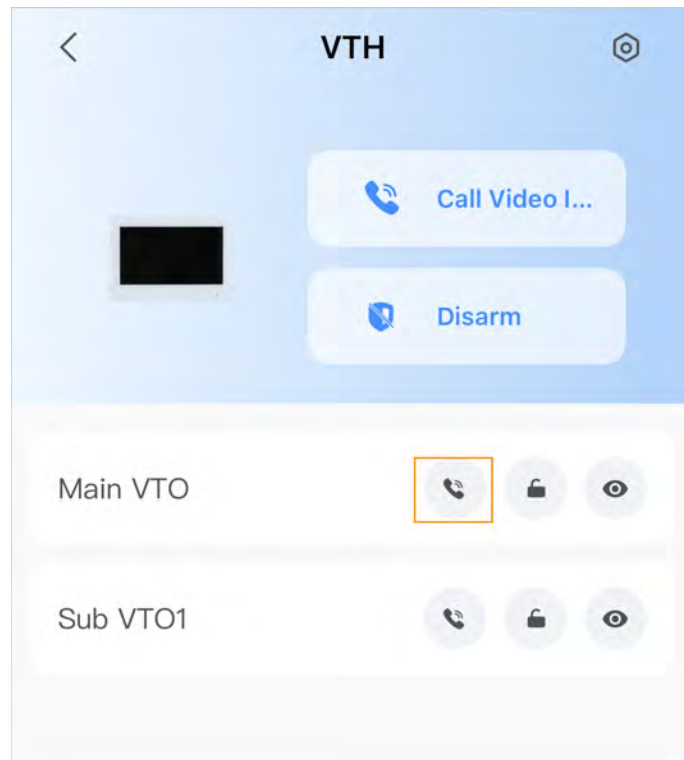

5.7 DMSS Unlocking Door

Procedure



- Step 1 On the **Home** screen, tap , select the VTH you have just added, and then tap **Device Details** to go to the function screen.
- Step 2 Tap  to unlock the door.

Figure 5-11 Unlock the door



5.8 DMSS Monitoring VTO

Make sure that the VTH and VTO are properly connected.

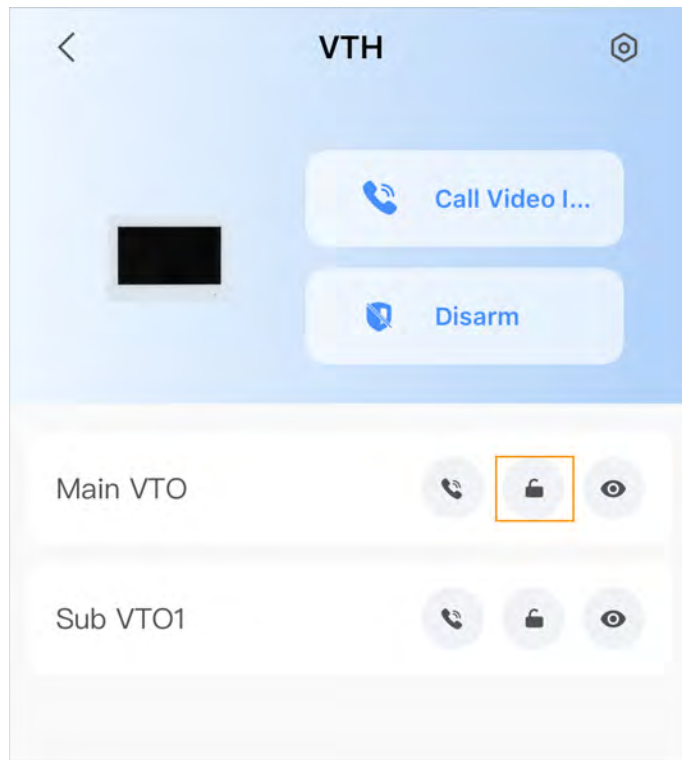
Procedure

- Step 1 On the **Home** screen, tap **...**, select the VTH you have just added, and then tap **Device Details** to go to the function screen.
- Step 2 Tap  to view the monitoring video of the VTO.

Figure 5-12 View monitoring video

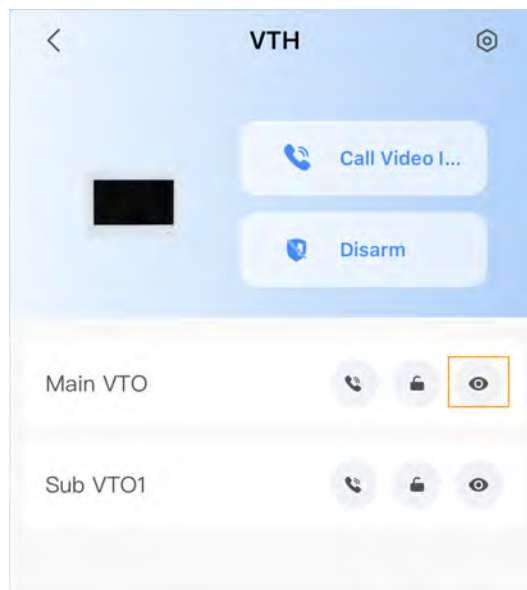

Figure 5-13 Viewing monitoring video

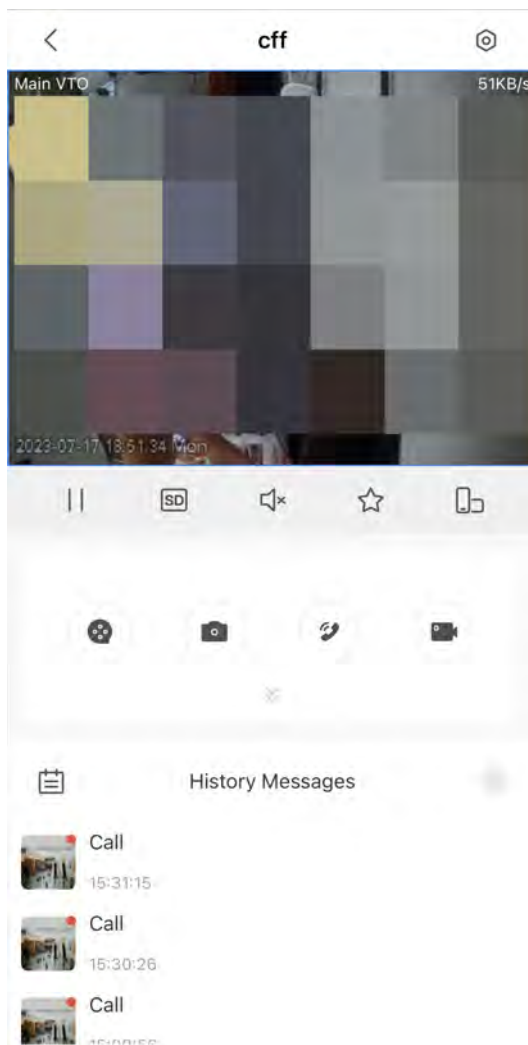











Table 5-1 Video call function icons

Function	Description
	Play/Pause.
	Mute/Unmute.
	Change the image orientation to landscape.
	Favorites. Select a video, tap  , and then select an existing file that you want to save the video to.
	Video stream. Tap the icon to switch between SD and HD video quality.
	Video playback.

Function	Description
	Take snapshot.
	Video recording.
	Answer/End the call.

5.9 Viewing Alarm Information

Procedure

- Step 1 On the **Message** screen, tap **Alarm Message** to view the alarm recorded reported from the VTOs and VTHs.

Figure 5-14 Viewing alarm records

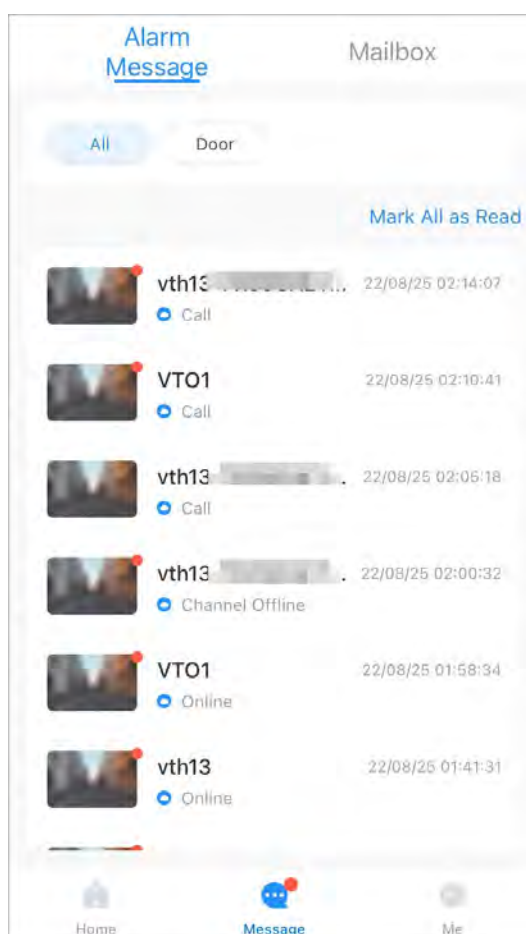

5.10 Device Sharing

Once one user has added the VTH, the user can share the binding relationship with other users.

Procedure

- Step 1 On the **Home** screen, select the VTH you have just added, and tap the .

Step 2 Select **Device Sharing**.

Figure 5-15 Device sharing (1)

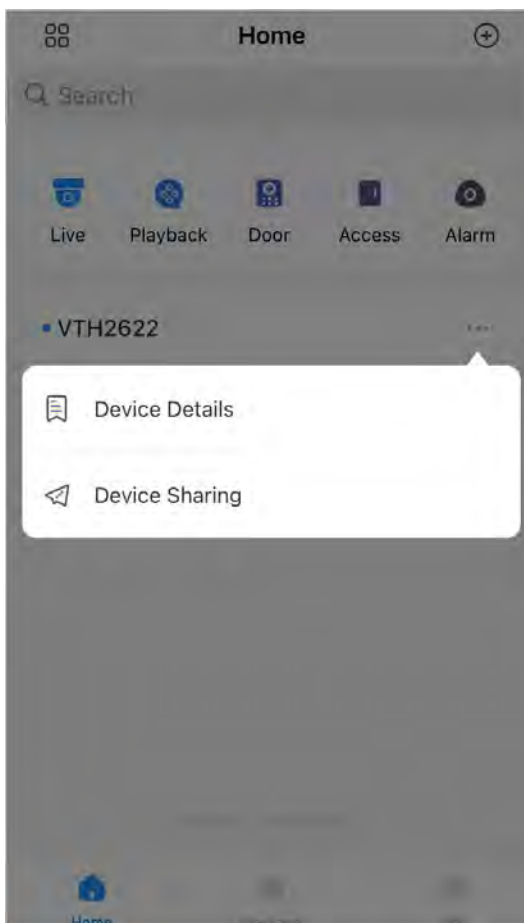

Step 3 On the **Device Sharing** screen, tap  to scan the QR code of the users you want to share the device.

Figure 5-16 Device sharing (2)

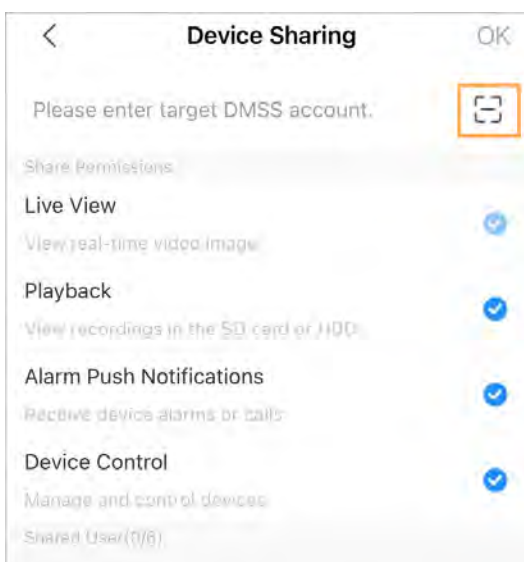
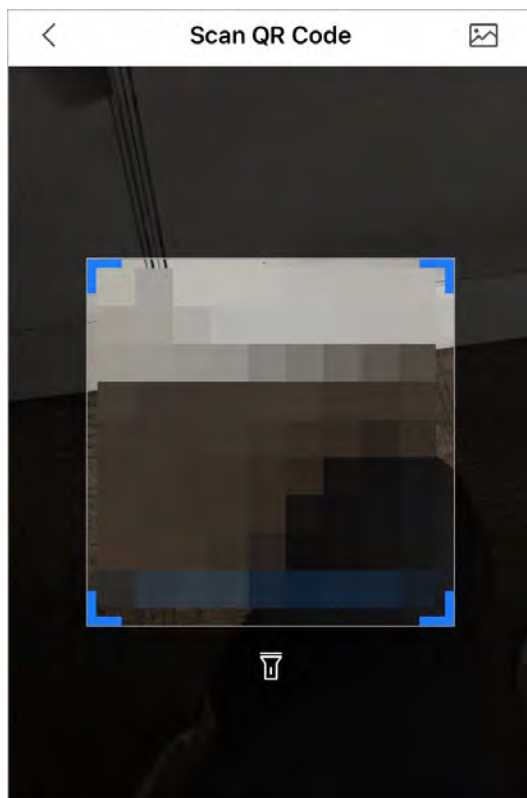

Figure 5-17 Scan QR code of the user you want to share



Step 4 After scanning the QR code, the user that receives the sharing has to refresh the **Home** screen to update the sharing information.

Related Operations

To Obtain the QR Code of the User that Receives the Sharing.

1. Log in to the DMSS account of the user that to receive the sharing.
2. Tap **Me**, and tap the QR code icon at the top of the screen.

Figure 5-18 Obtain the QR code

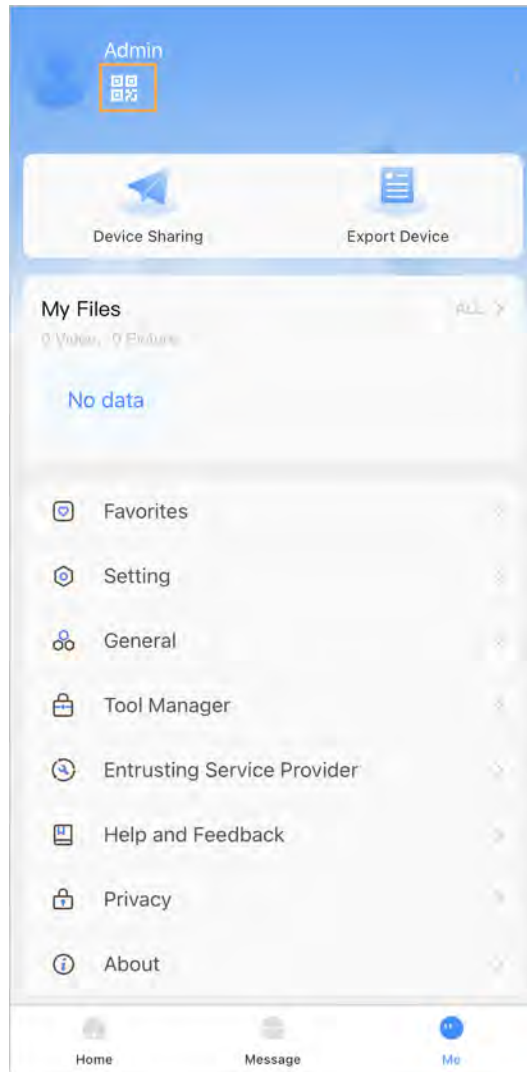

Figure 5-19 Obtain the QR code (2)



Appendix 1 Cybersecurity Recommendations

Mandatory actions to be taken for basic device network security:

1. Use Strong Passwords

Please refer to the following suggestions to set passwords:

- The length should not be less than 8 characters.
- Include at least two types of characters; character types include upper and lower case letters, numbers and symbols.
- Do not contain the account name or the account name in reverse order.
- Do not use continuous characters, such as 123, abc, etc.
- Do not use overlapped characters, such as 111, aaa, etc.

2. Update Firmware and Client Software in Time

- According to the standard procedure in Tech-industry, we recommend to keep your device (such as NVR, DVR, IP camera, etc.) firmware up-to-date to ensure the system is equipped with the latest security patches and fixes. When the device is connected to the public network, it is recommended to enable the "auto-check for updates" function to obtain timely information of firmware updates released by the manufacturer.
- We suggest that you download and use the latest version of client software.

"Nice to have" recommendations to improve your device network security:

1. Physical Protection

We suggest that you perform physical protection to device, especially storage devices. For example, place the device in a special computer room and cabinet, and implement well-done access control permission and key management to prevent unauthorized personnel from carrying out physical contacts such as damaging hardware, unauthorized connection of removable device (such as USB flash disk, serial port), etc.

2. Change Passwords Regularly

We suggest that you change passwords regularly to reduce the risk of being guessed or cracked.

3. Set and Update Passwords Reset Information Timely

The device supports password reset function. Please set up related information for password reset in time, including the end user's mailbox and password protection questions. If the information changes, please modify it in time. When setting password protection questions, it is suggested not to use those that can be easily guessed.

4. Enable Account Lock

The account lock feature is enabled by default, and we recommend you to keep it on to guarantee the account security. If an attacker attempts to log in with the wrong password several times, the corresponding account and the source IP address will be locked.

5. Change Default HTTP and Other Service Ports

We suggest you to change default HTTP and other service ports into any set of numbers between 1024–65535, reducing the risk of outsiders being able to guess which ports you are using.

6. Enable HTTPS

We suggest you to enable HTTPS, so that you visit Web service through a secure communication channel.

7. MAC Address Binding

We recommend you to bind the IP and MAC address of the gateway to the device, thus reducing the risk of ARP spoofing.

8. Assign Accounts and Privileges Reasonably

According to business and management requirements, reasonably add users and assign a minimum set of permissions to them.

9. **Disable Unnecessary Services and Choose Secure Modes**

If not needed, it is recommended to turn off some services such as SNMP, SMTP, UPnP, etc., to reduce risks.

If necessary, it is highly recommended that you use safe modes, including but not limited to the following services:

- SNMP: Choose SNMP v3, and set up strong encryption passwords and authentication passwords.
- SMTP: Choose TLS to access mailbox server.
- FTP: Choose SFTP, and set up strong passwords.
- AP hotspot: Choose WPA2-PSK encryption mode, and set up strong passwords.

10. **Audio and Video Encrypted Transmission**

If your audio and video data contents are very important or sensitive, we recommend that you use encrypted transmission function, to reduce the risk of audio and video data being stolen during transmission.

Reminder: encrypted transmission will cause some loss in transmission efficiency.

11. **Secure Auditing**

- Check online users: we suggest that you check online users regularly to see if the device is logged in without authorization.
- Check device log: By viewing the logs, you can know the IP addresses that were used to log in to your devices and their key operations.

12. **Network Log**

Due to the limited storage capacity of the device, the stored log is limited. If you need to save the log for a long time, it is recommended that you enable the network log function to ensure that the critical logs are synchronized to the network log server for tracing.

13. **Construct a Safe Network Environment**

In order to better ensure the safety of device and reduce potential cyber risks, we recommend:

- Disable the port mapping function of the router to avoid direct access to the intranet devices from external network.
- The network should be partitioned and isolated according to the actual network needs. If there are no communication requirements between two sub networks, it is suggested to use VLAN, network GAP and other technologies to partition the network, so as to achieve the network isolation effect.
- Establish the 802.1x access authentication system to reduce the risk of unauthorized access to private networks.
- Enable IP/MAC address filtering function to limit the range of hosts allowed to access the device.