

DK PREMIUM

PC POWER SUPPLY



edited by Miku
Version 1.1
2021.03.12

PC POWER SUPPLY

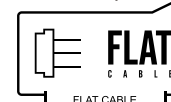
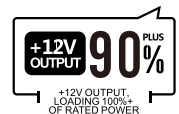



MODEL : PS-500AX

Dimensions(L*W*H)	140*150*86 MM
Modular	Non-Modular
Certifications	80 PLUS BRONZE
Warranty	3 years
Efficiency	87% @ Typical Load
PFC	Active PFC
Fan Size	120MM Hydraulic Bearing
Protections	UVP, OVP, OPP, SCP, Lightning Protection
Operation Temperature	0~40°C
Circuit Structure	Double Forward



MODEL : PS-600AX

Dimensions(L*W*H)	140*150*86 MM
Modular	Non-Modular
Certifications	80 PLUS BRONZE
Warranty	3 years
Efficiency	87% @ Typical Load
PFC	Active PFC
Fan Size	120MM Hydraulic Bearing
Protections	UVP, OVP, OPP, SCP, Lightning Protection
Operation Temperature	0~40°C
Circuit Structure	Double Forward



MODEL : PS-700AX

Dimensions(L*W*H)	140*150*86 MM
Modular	Non-Modular
Certifications	80 PLUS BRONZE
Warranty	3 years
Efficiency	87% @ Typical Load
PFC	Active PFC
Fan Size	120MM Hydraulic Bearing
Protections	UVP, OVP, OPP, SCP, Lightning Protection
Operation Temperature	0~40°C
Circuit Structure	Double Forward



MODEL : PS-800AX

Dimensions(L*W*H)	140*150*86 MM
Modular	Non-Modular
Certifications	80 PLUS BRONZE
Warranty	3 years
Efficiency	87% @ Typical Load
PFC	Active PFC
Fan Size	120MM Hydraulic Bearing
Protections	UVP, OVP, OPP, SCP, Lightning Protection
Operation Temperature	0~40°C
Circuit Structure	Double Forward



100-240Vac
50-60Hz
10A Max



+5V 20A
+3.3V 20A
+12V 41A
+5VSB 2.5A
-12V 0.3A



+5V/+3.3V 100W
+12V 492W
RATED PWOER
500W



100-240Vac
50-60Hz
10A Max



+5V 20A
+3.3V 20A
+12V 50A
+5VSB 2.5A
-12V 0.3A



+5V/+3.3V 100W
+12V 600W
RATED PWOER
600W

//// GAMING PC POWER SUPPLY



100-240Vac
50-60Hz
10A Max



100-240Vac
50-60Hz
10A Max



+5V 20A
+3.3V 20A
+12V 58A
+5VSB 2.5A
-12V 0.3A



+5V 20A
+3.3V 20A
+12V 66A
+5VSB 2.5A
-12V 0.3A



+5V/+3.3V 100W
+12V 696W
RATED PWOER
700W



+5V/+3.3V 100W
+12V 792W
RATED PWOER
800W

//// GAMING PC POWER SUPPLY

Safety & Regular

EAC CB RoHS FC CE

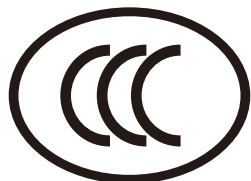

SAA-202494-EA



GAMING PC POWER SUPPLY // // // //

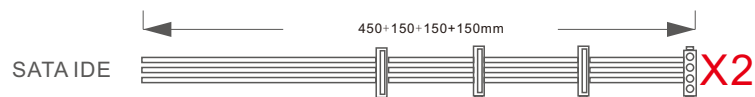
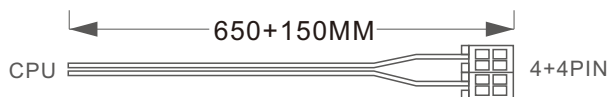
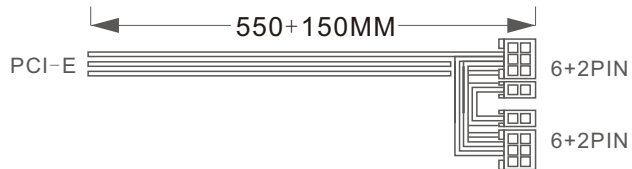
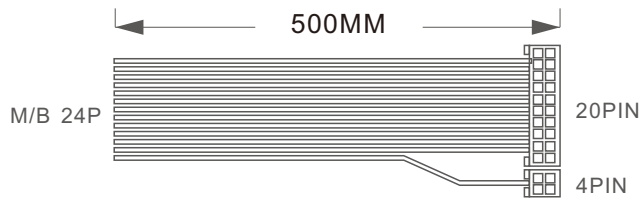

MODEL : PS-500AX

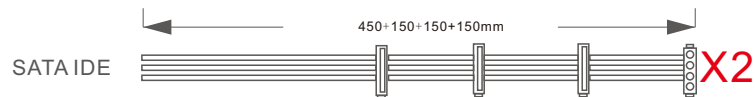
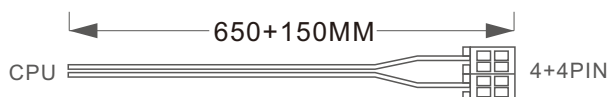
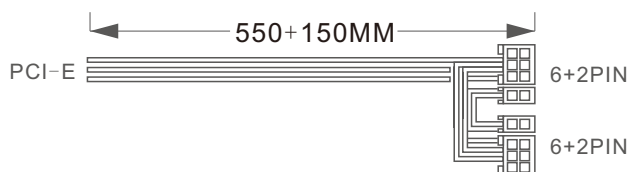
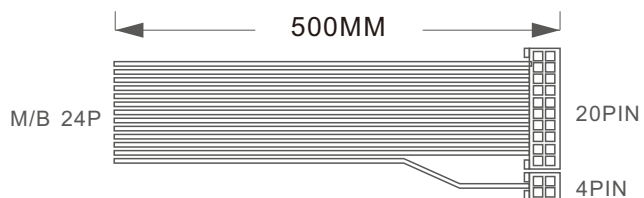

MODEL : PS-600 AX

//// GAMING PC POWER SUPPLY

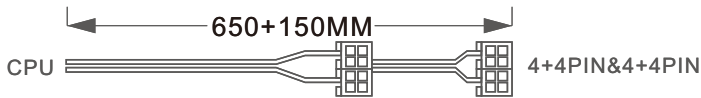
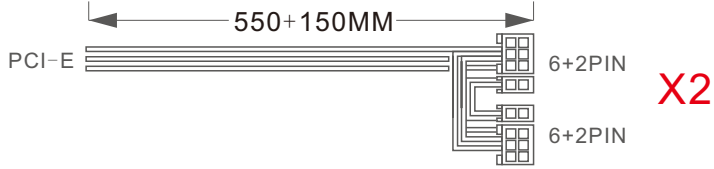
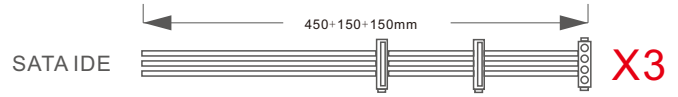
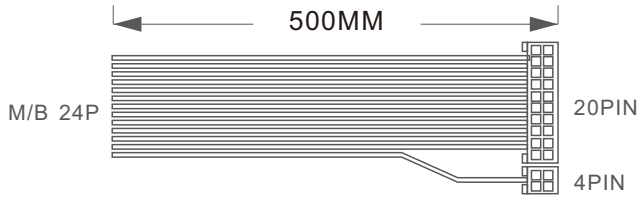

MODEL : PS-700AX

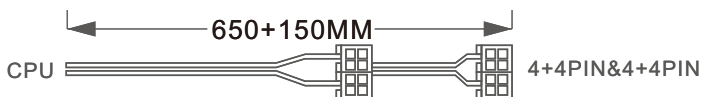
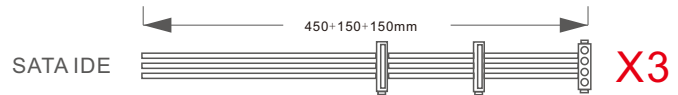
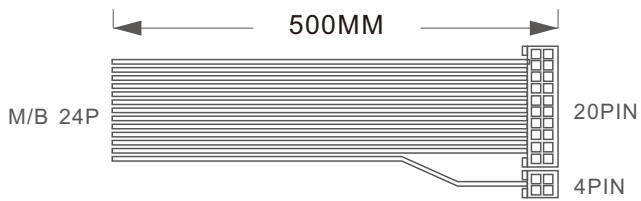

MODEL : PS-800 AX

GAMING PC POWER SUPPLY // // //

1 NON - Modular Connector Guideline

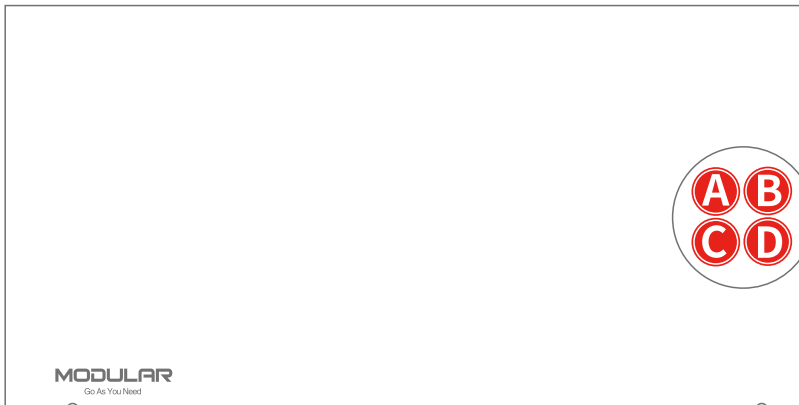

PSU modular port

PC Hardware

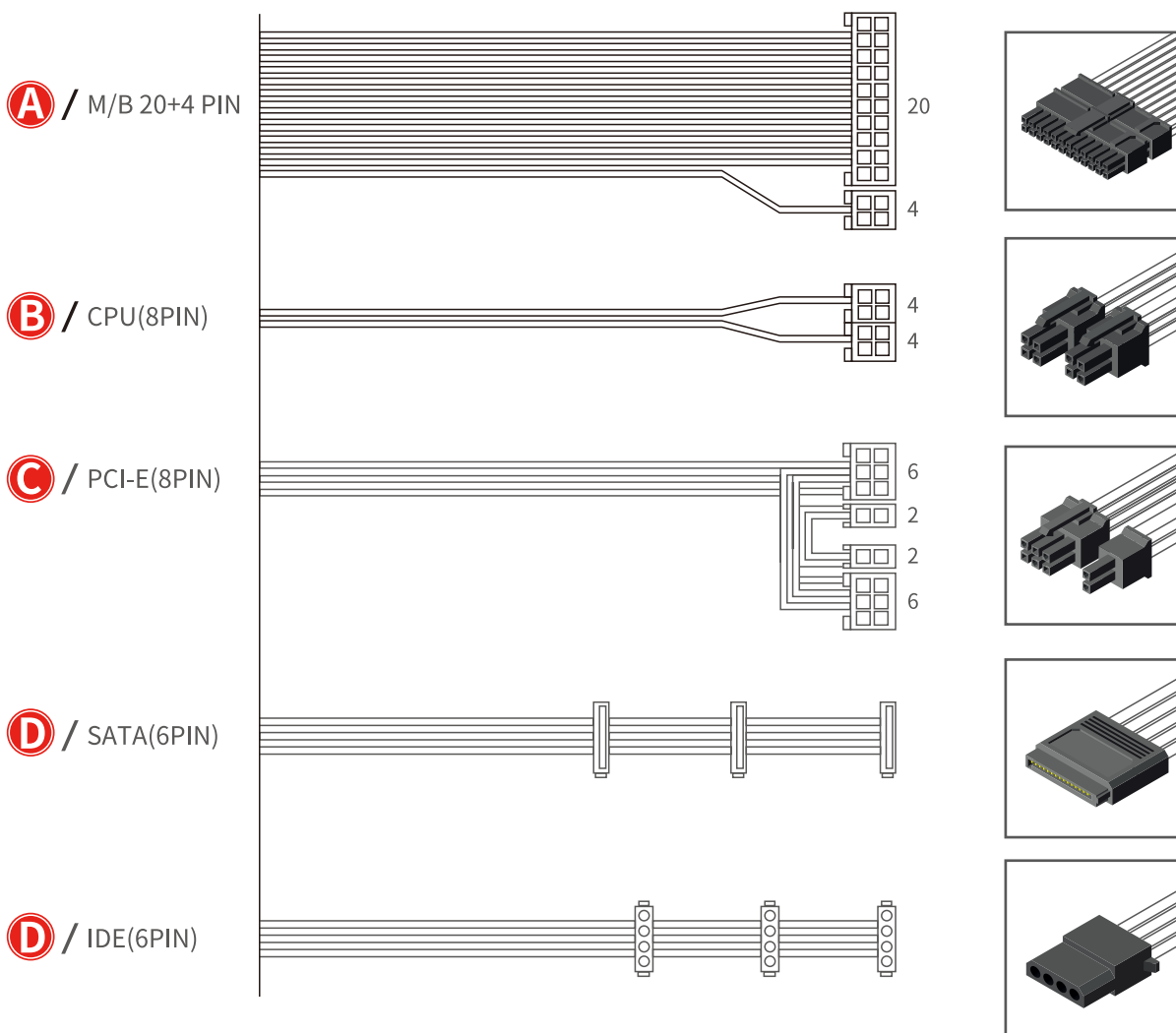

////// GAMING PC POWER SUPPLY

1 PC connection guide **Guideline**

1 Install the PSU into the PC case with cooling fan side at the bottom, then screw on.

2 24PIN (20+4) connector connects motherboard.

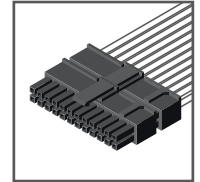

3 8PIN (4+4) connector connects CPU.

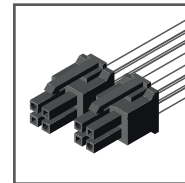

4 8PIN (6+2) connector connects VGA.

Note: There are multiple kinds of VGA connectors, 6PIN, 6+2PIN&6PIN, 6+2PIN&6+2PIN. Please select your PSU as your requirement.

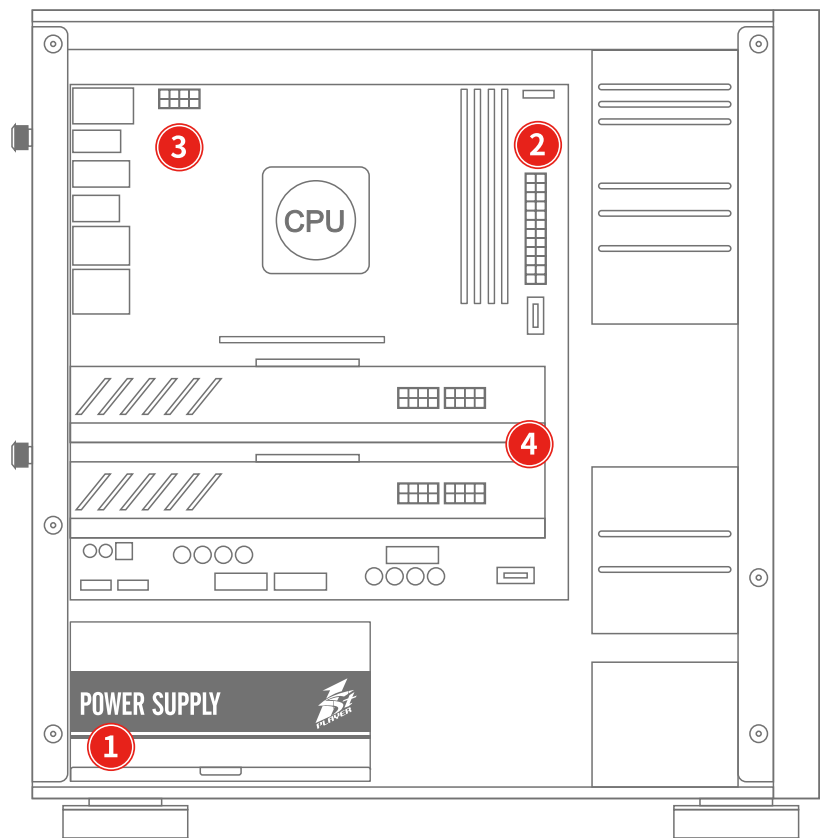
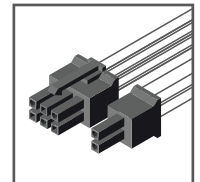

PC connection guide **Guideline**

- 5** SATA connector connects hard drive. IDE connector connects case fan.

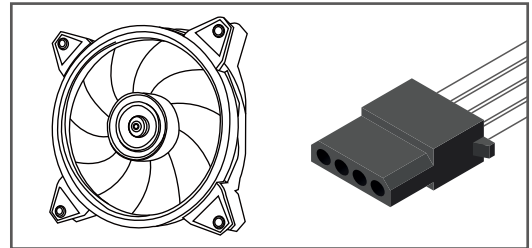
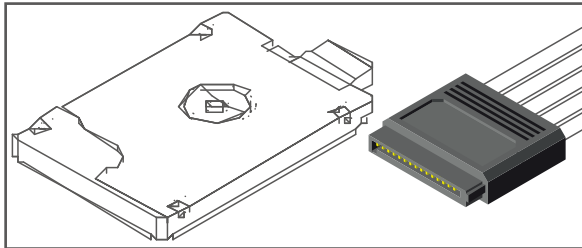

- 6** Connect the motherboard jumpers, USB connectors. (any connection problem please contact motherboard manufacturer)

- 7** Connect the power cord. Make sure the I/O button is on. Press the case power button to power on.

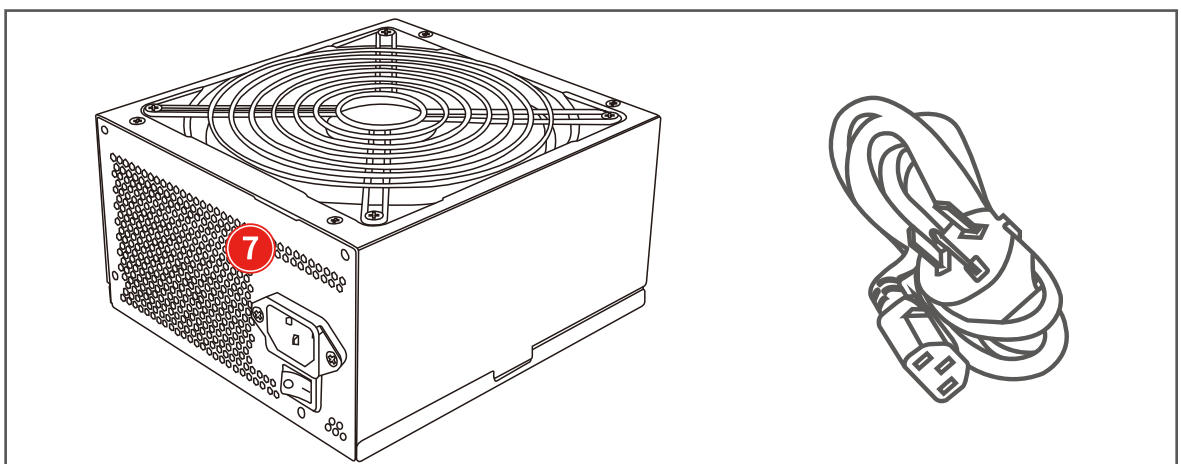

////// GAMING PC POWER SUPPLY