

PPB-32

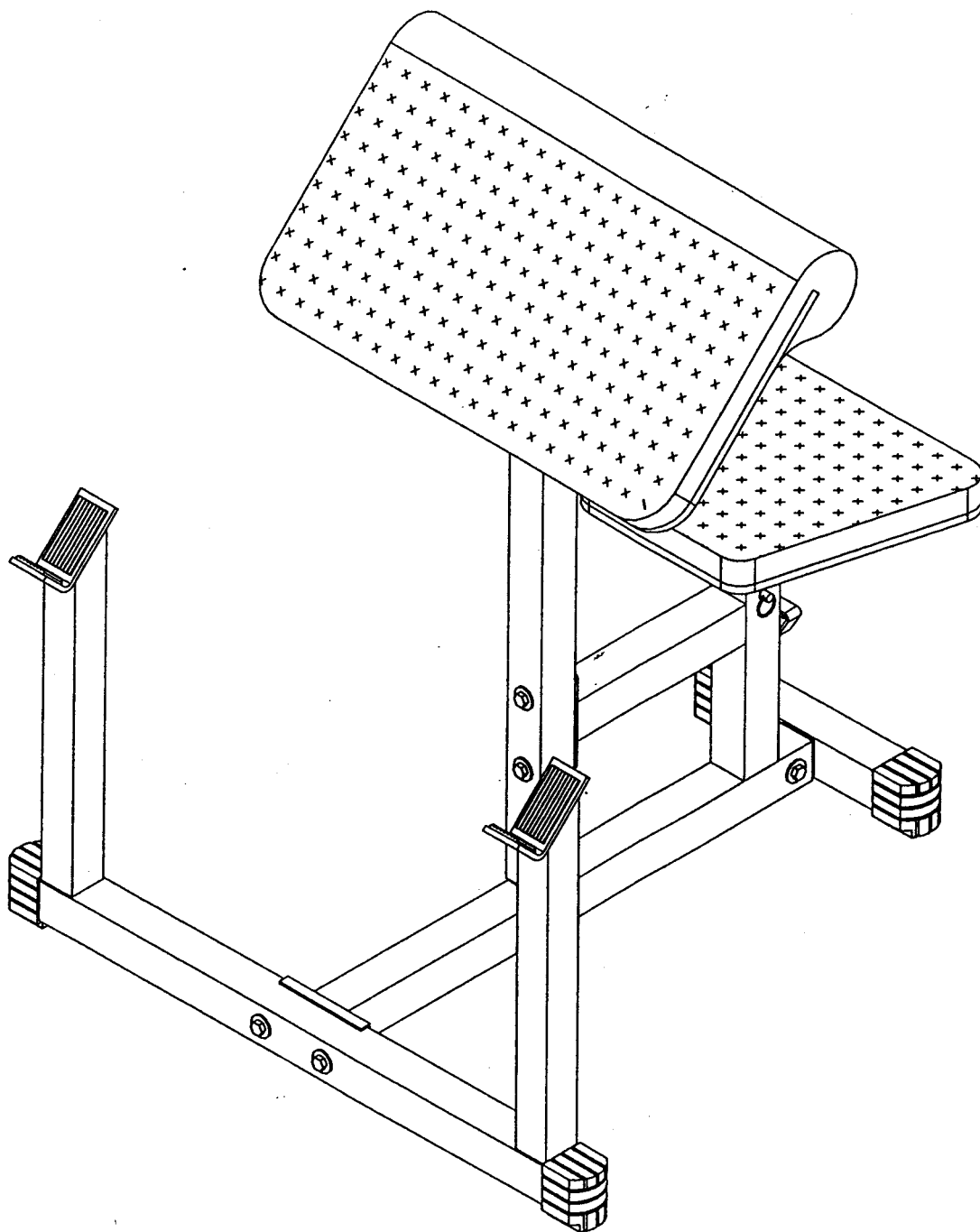

HARDWARE ILLUSTRATION SHEET

- A1. M10x70 HEX HEAD BOLT [4PCS]
- A2. M10x65 HEX HEAD BOLT [1PCS]
- A3. 5/16"x25 HEX HEAD BOLT [6PCS]
- B1. M10 NYLON LOCK NUT [5PCS]
- C1. M10 (I.D) WASHER [6PCS]
- C2. 5/16" (I.D)WASHER [6PCS]
- C3. 5/16" SPRING WASHER [6PCS]
- D1. 2" X 2" END CAP (E4028) [4PCS]
- D2. HEIGHT ADJUSTMENT KNOB (E1007) [1PCS]
- D3. 1 1/2"x1 1/2" RUBBER BAR CATCH (E2006) [2PCS]
- D4. 1 1/2" X 3" RUBBER BAR CATCH (E2005) [2PCS]

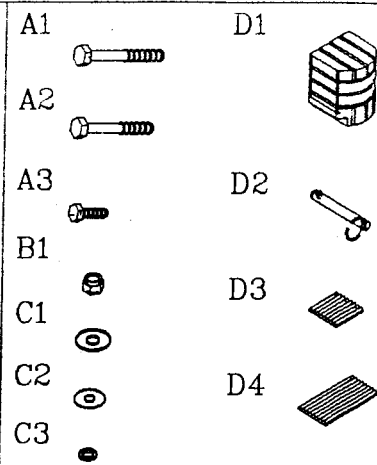

PARTS ILLUSTRATION SHEET

A [1PCS]

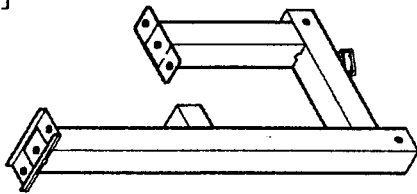

D [1PCS]

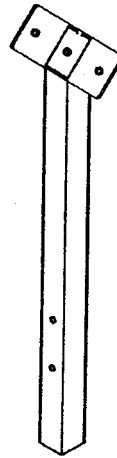

E [1PCS]

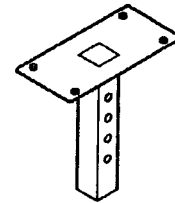

B [1PCS]

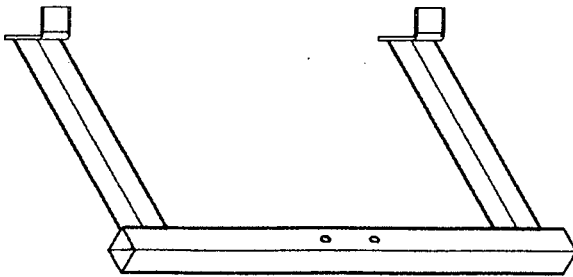

G [1PCS]

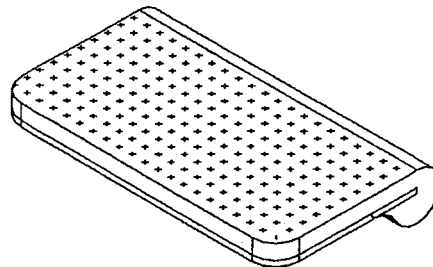

C [1PCS]

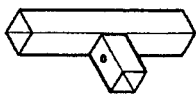

F [1PCS]

