





















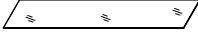
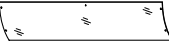

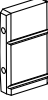





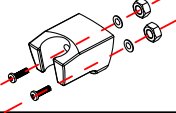





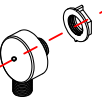
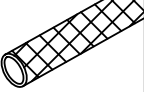



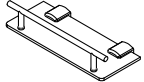

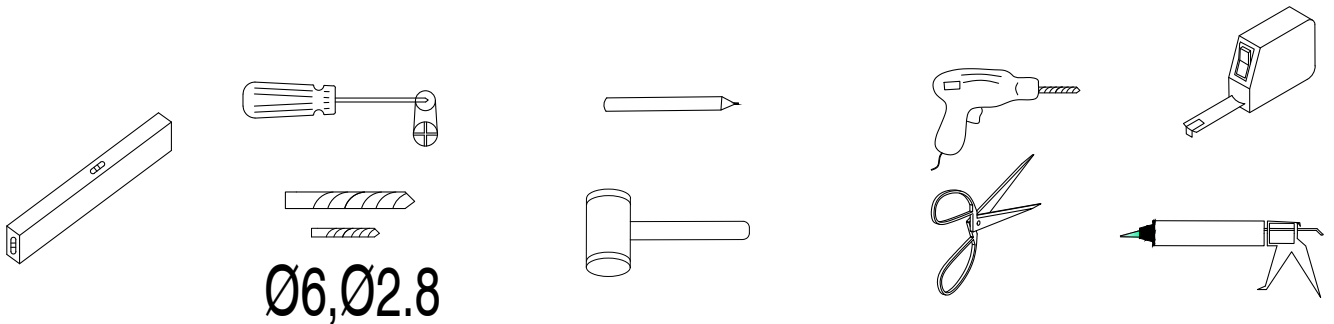





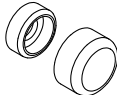

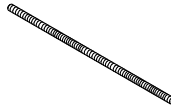
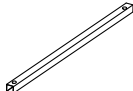
A		8	I		2	Q		4
B	 ST4X35	8	J	 ST4X10	8	R	 ST4X8	4
C		2	K		4	S		1
D		2	L	 ST4X10	4	T		1
E		1	M		2	U		1
F		4	N		2	W		1
G		2	O		2			
H		4	P		2			

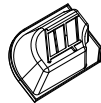
a1		1	g1		1	m1		1
b1		1	h1	 ST4X12	28	n1		4
c1		1	i1		1			
d1		1	j1		2			
e1		1	k1		1			
f1		2	l1		1			



A-1		6	F-1		1	L-1		3
B-1		6	G-1		1	M-1		3
C-1		3	H-1		4	N-1		1
D-1		27	I-1		1	O-1		1
E-1		4	J-1		1	P-1		1
			K-1		5	Q-1		1

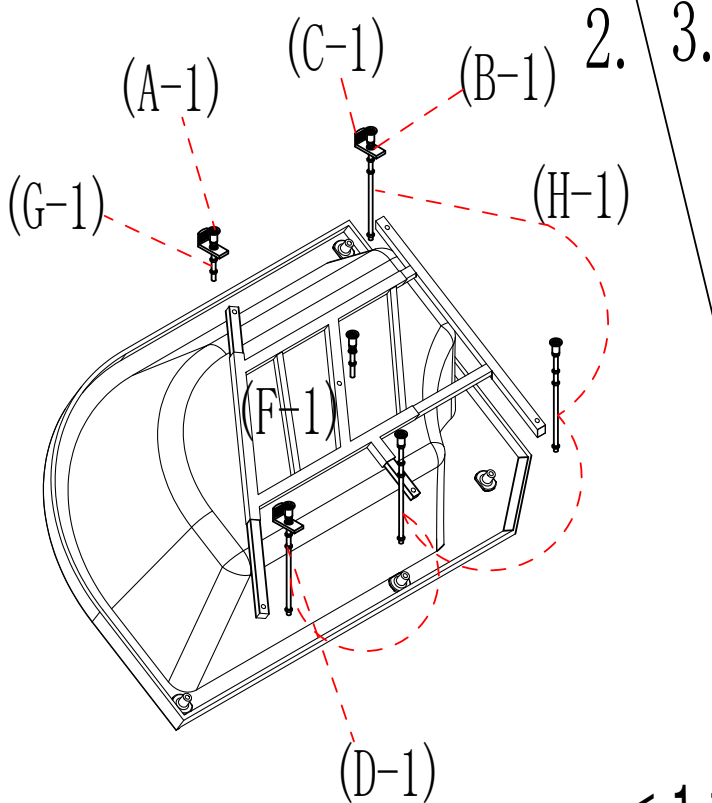
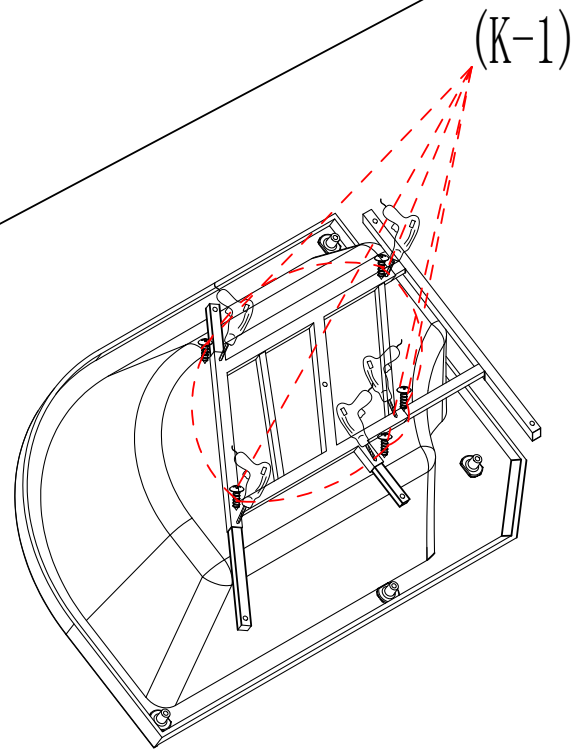
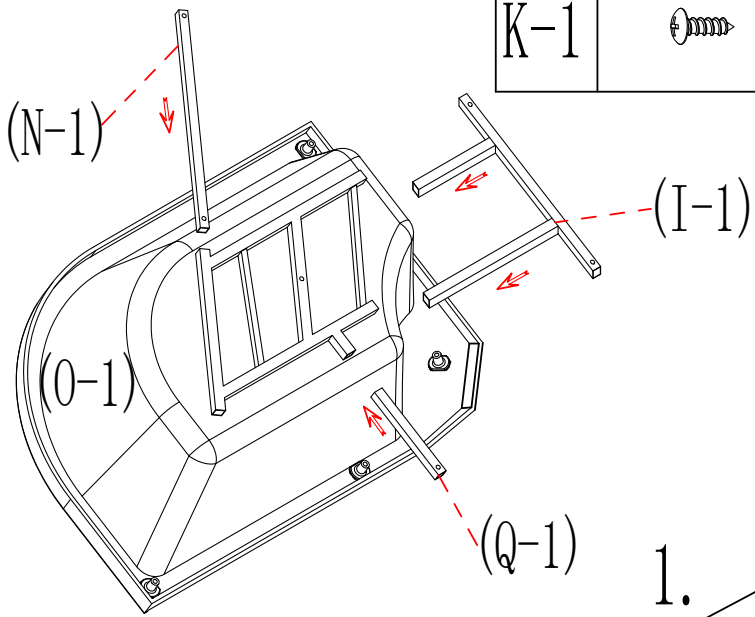

< 1 >

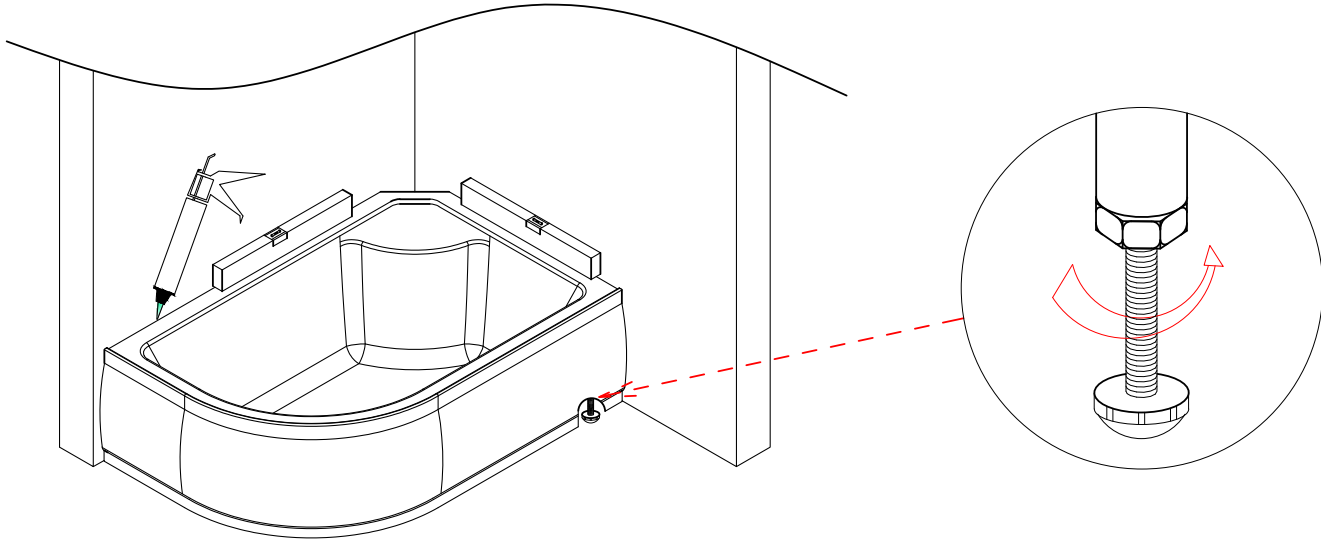
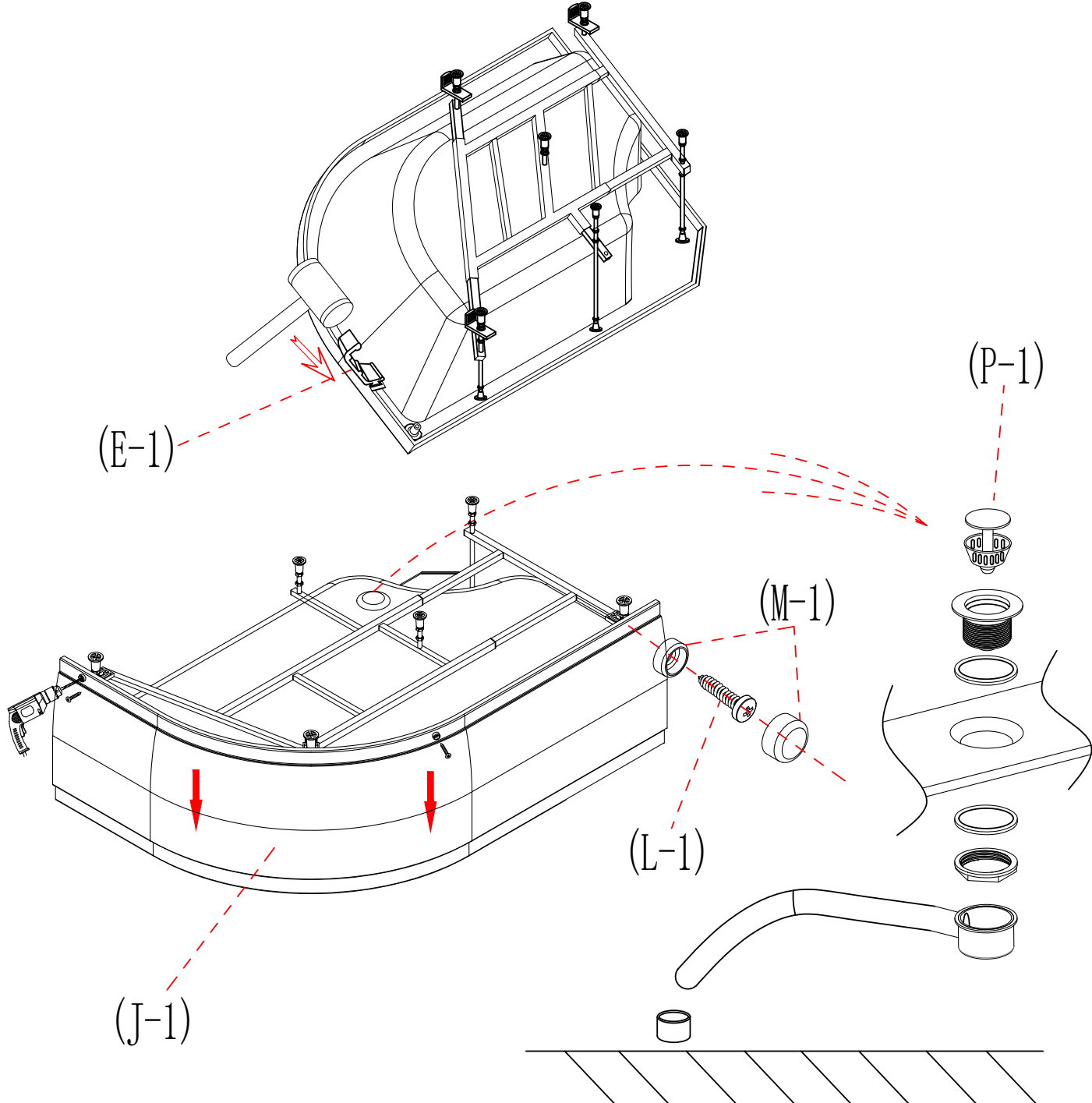

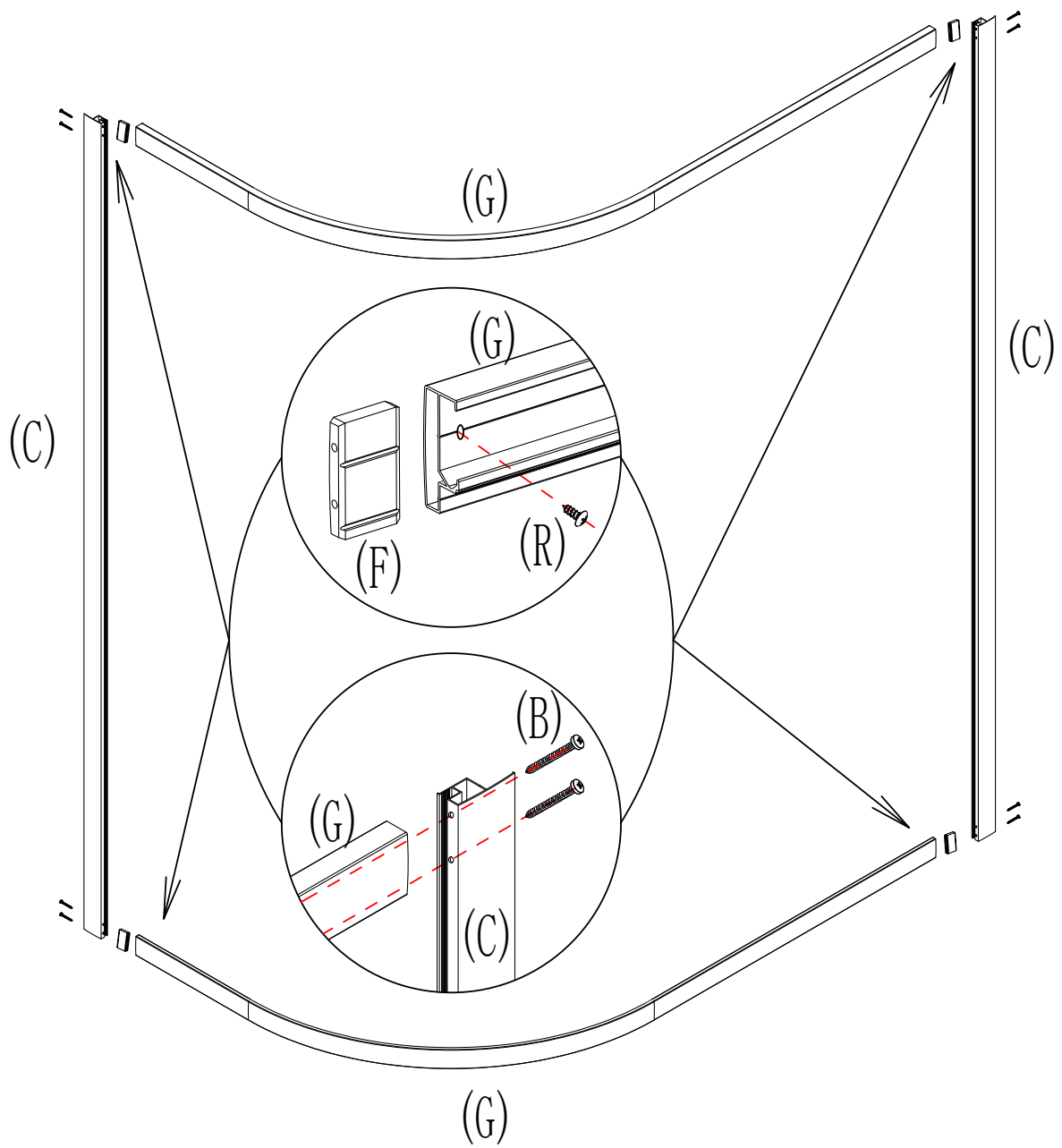

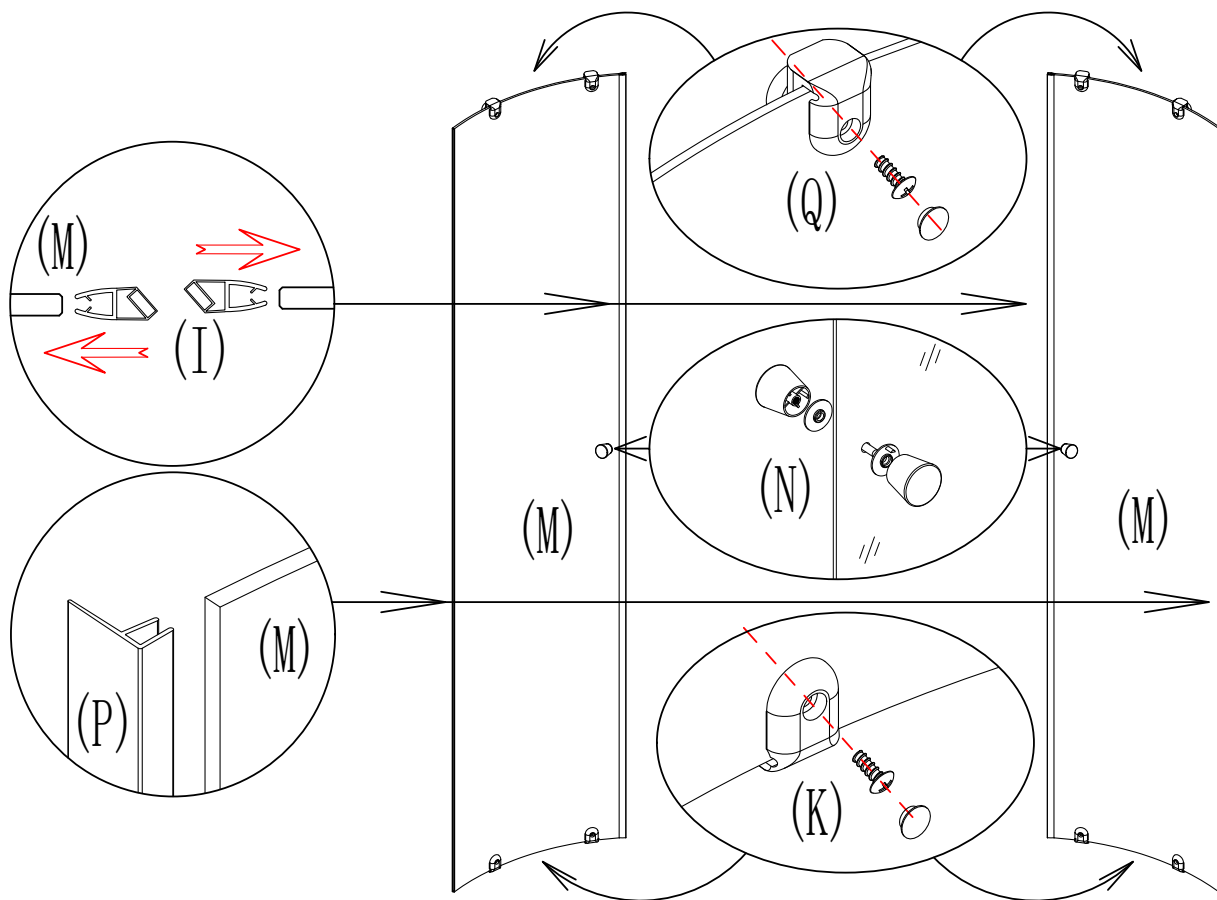
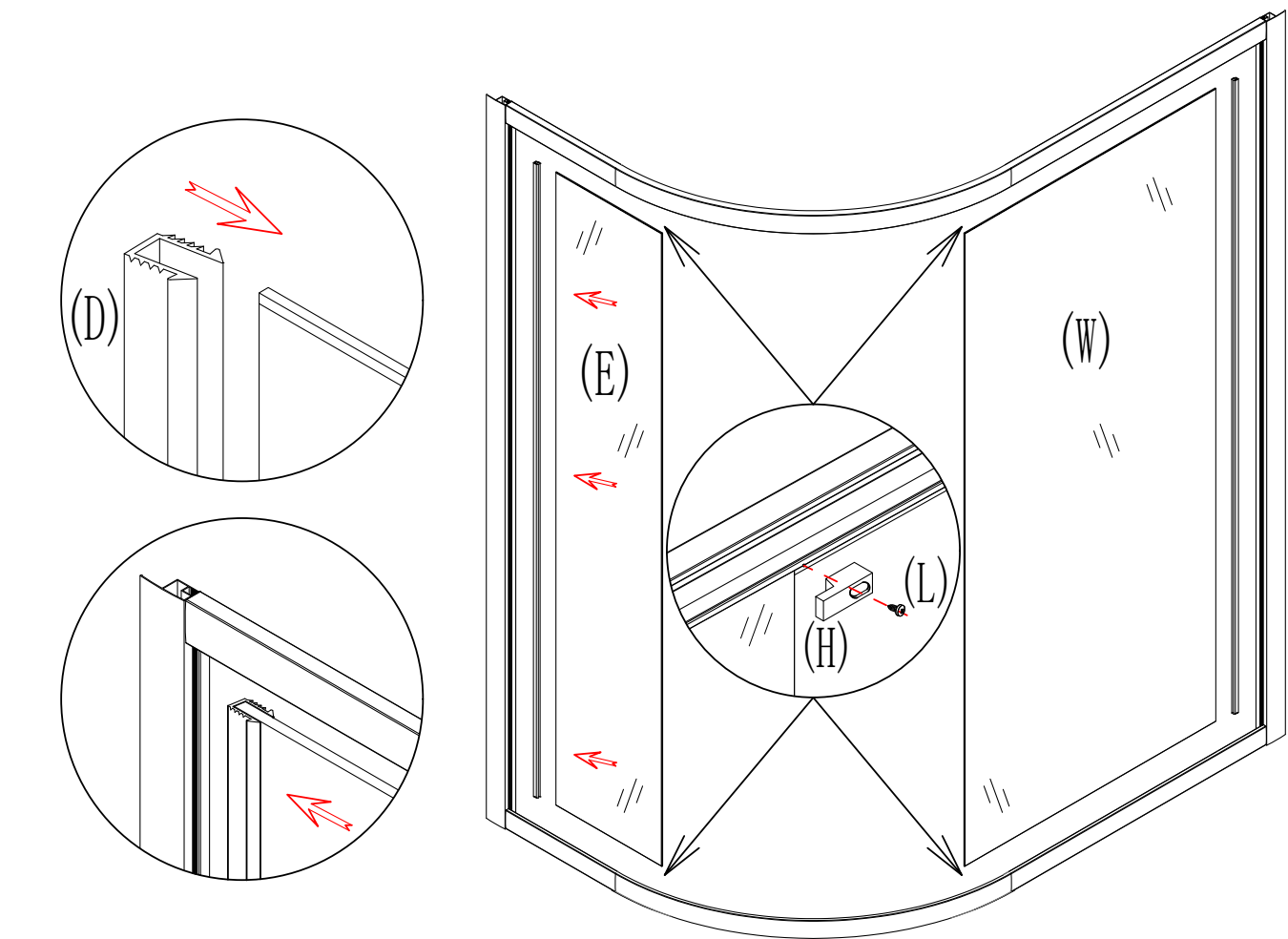

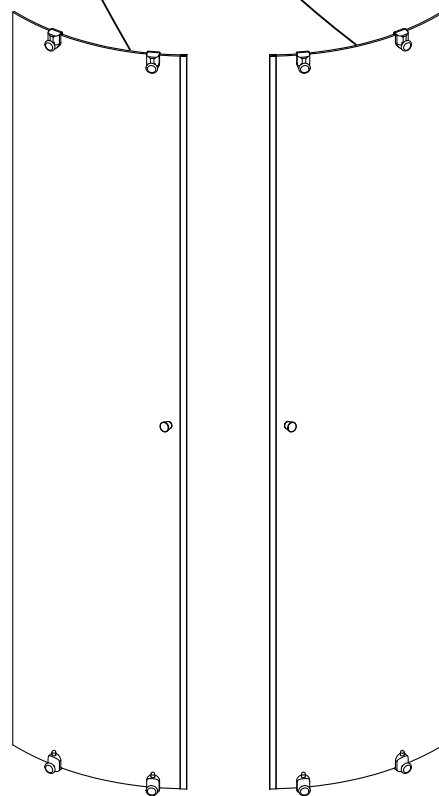
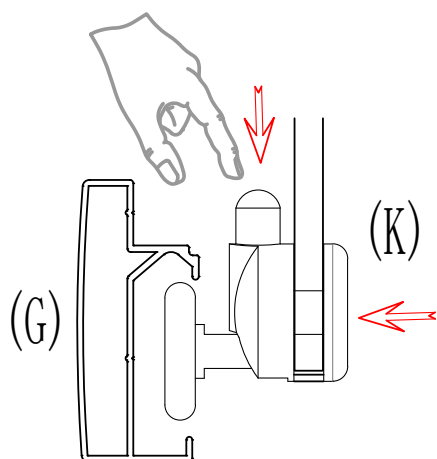
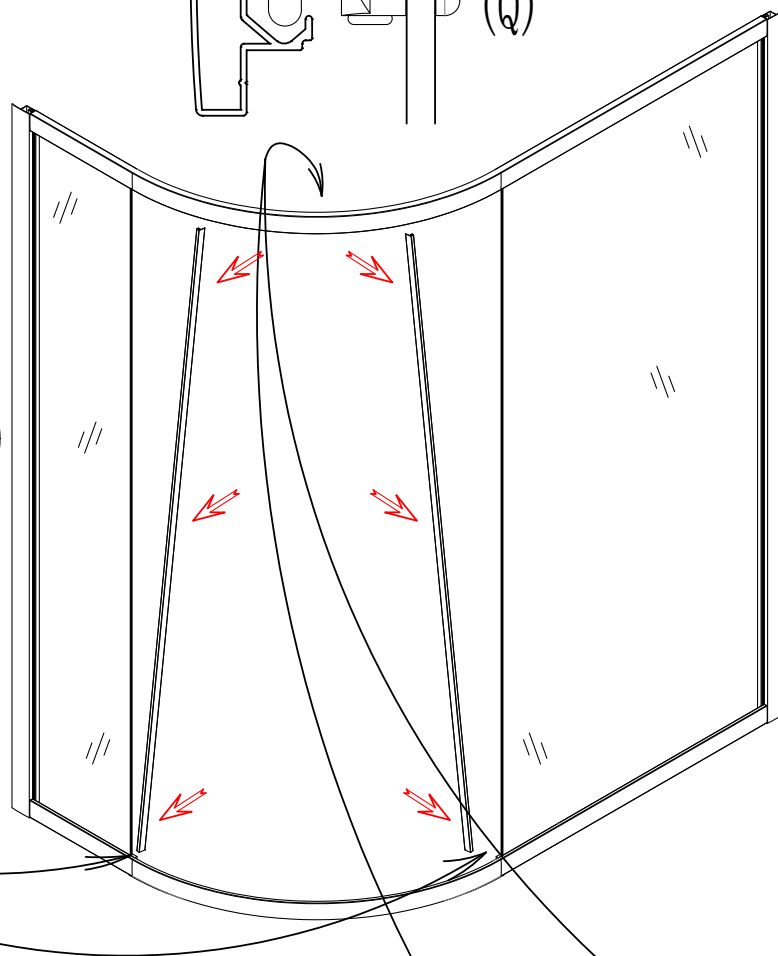
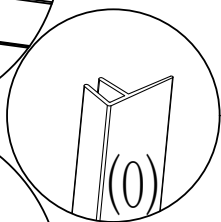
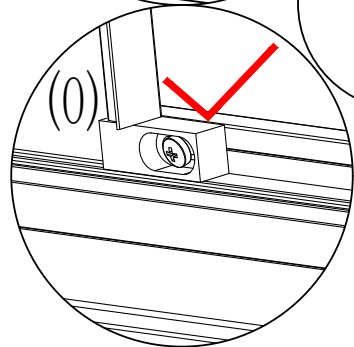
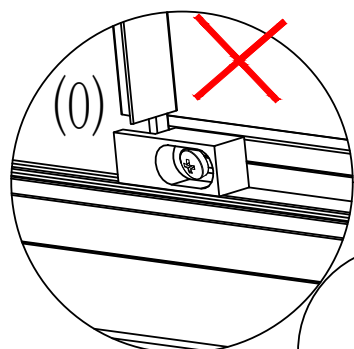

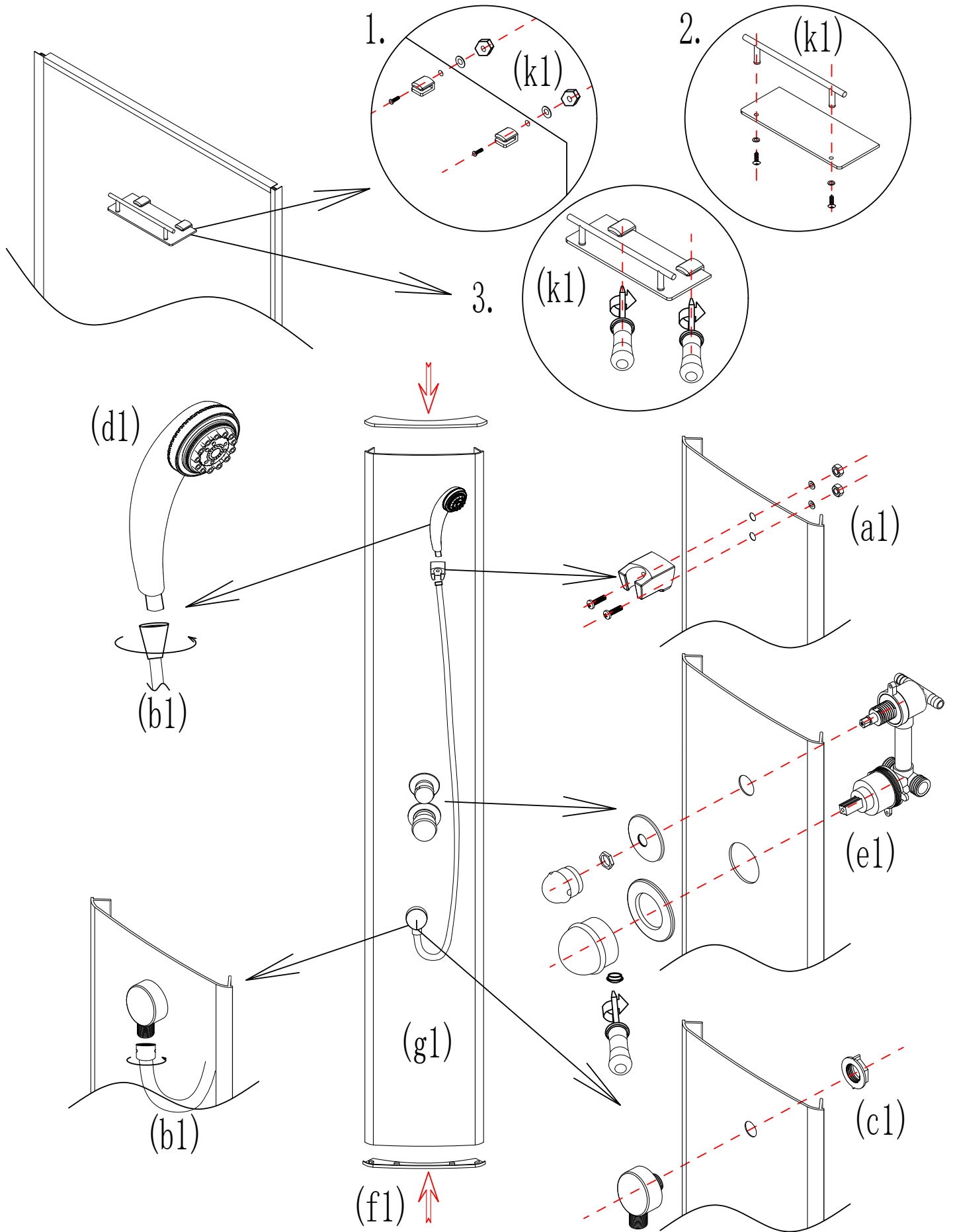

< 6 >

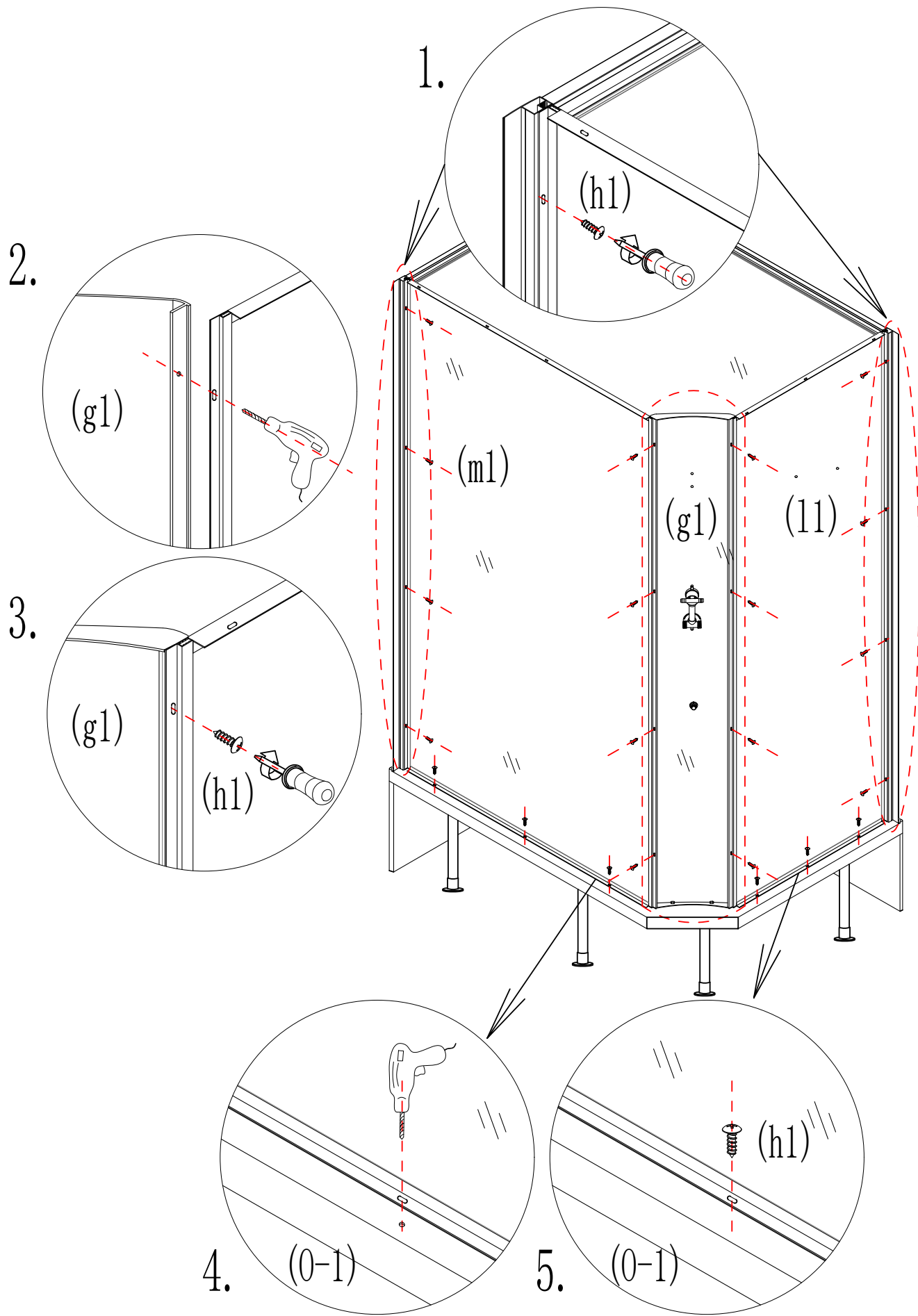

< 7 >

