





















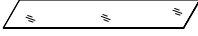
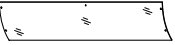

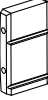





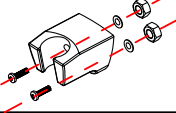





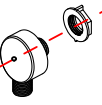
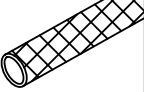



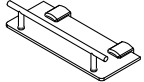

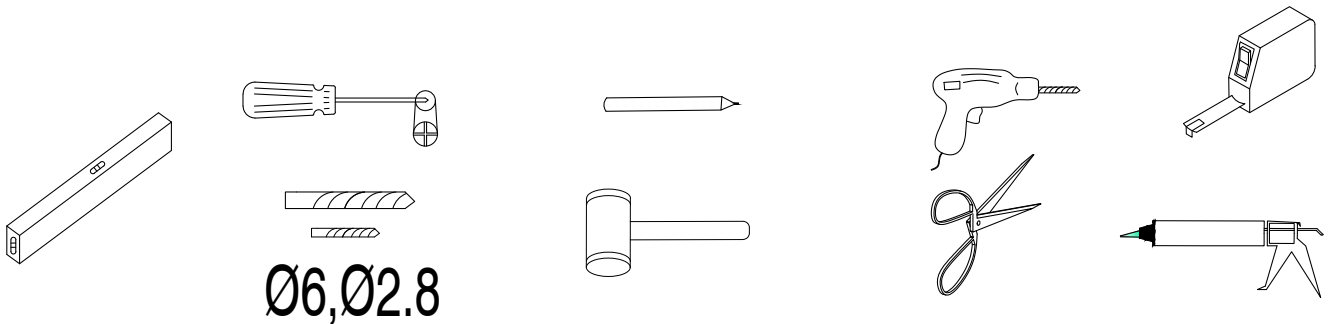





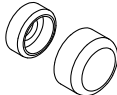

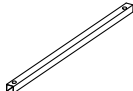
| | | | | | | | | |
|---|---|---|---|---|---|---|--|---|
| A |  | 8 | I |  | 2 | Q |  | 4 |
| B |  ST4X35 | 8 | J |  ST4X10 | 8 | R |  ST4X8 | 4 |
| C |  | 2 | K |  | 4 | S |  | 1 |
| D |  | 2 | L |  ST4X10 | 4 | T |  | 1 |
| E |  | 1 | M |  | 2 | U |  | 1 |
| F |  | 4 | N |  | 2 | W |  | 1 |
| G |  | 2 | O |  | 2 | | | |
| H |  | 4 | P |  | 2 | | | |

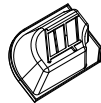
| | | | | | | | | |
|----|---|---|----|---|----|----|---|---|
| a1 |  | 1 | g1 |  | 1 | m1 |  | 1 |
| b1 |  | 1 | h1 |  ST4X12 | 28 | n1 |  | 4 |
| c1 |  | 1 | i1 |  | 1 | | | |
| d1 |  | 1 | j1 |  | 2 | | | |
| e1 |  | 1 | k1 |  | 1 | | | |
| f1 |  | 2 | l1 |  | 1 | | | |



| | | | | | | | | |
|-----|---|----|-----|---|---|-----|---|---|
| A-1 |  | 6 | F-1 |  | 1 | L-1 |  | 3 |
| B-1 |  | 6 | G-1 |  | 1 | M-1 |  | 3 |
| C-1 |  | 3 | H-1 |  | 4 | N-1 |  | 1 |
| D-1 |  | 27 | I-1 |  | 1 | O-1 |  | 1 |
| E-1 |  | 4 | J-1 |  | 1 | P-1 |  | 1 |
| | | | K-1 |  | 5 | Q-1 |  | 1 |

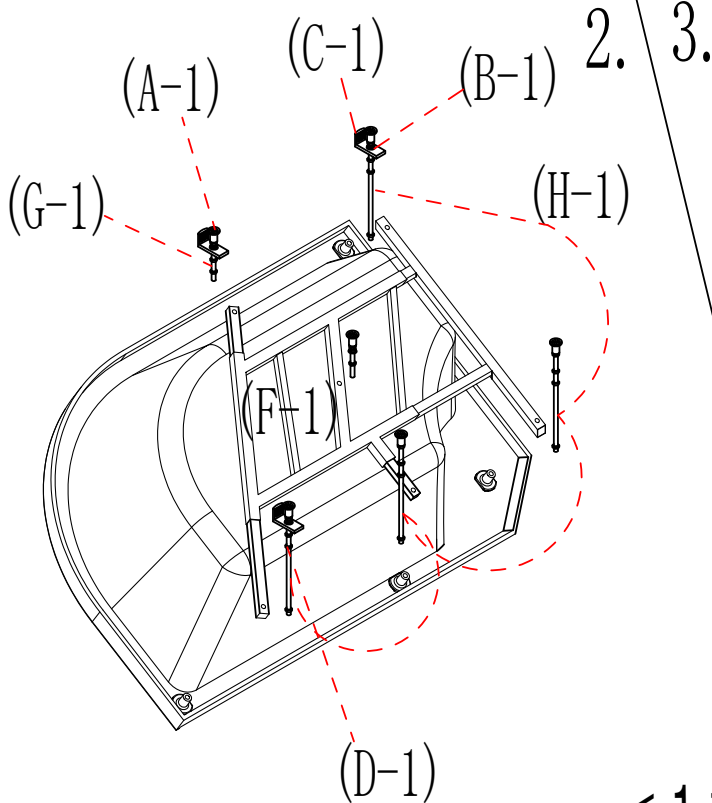
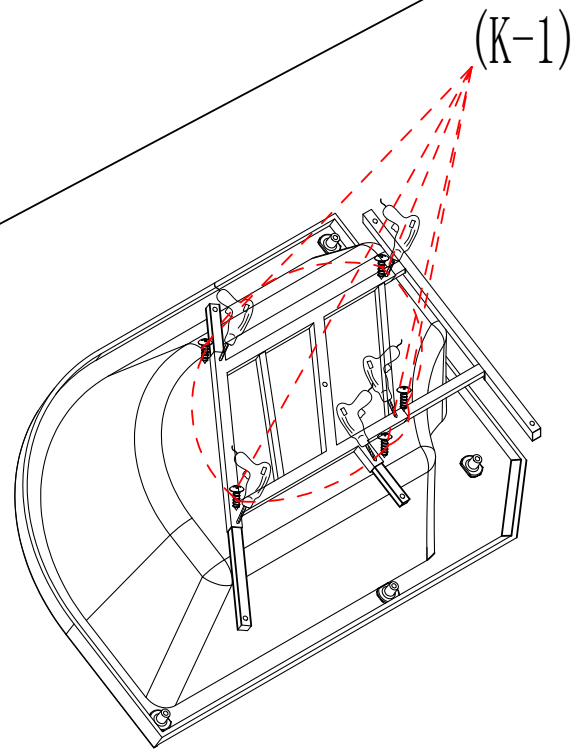
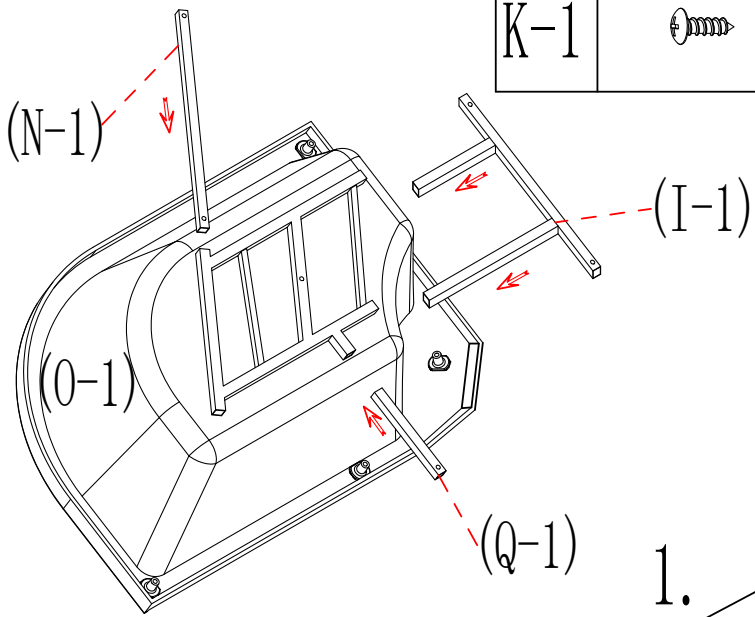

< 1 >

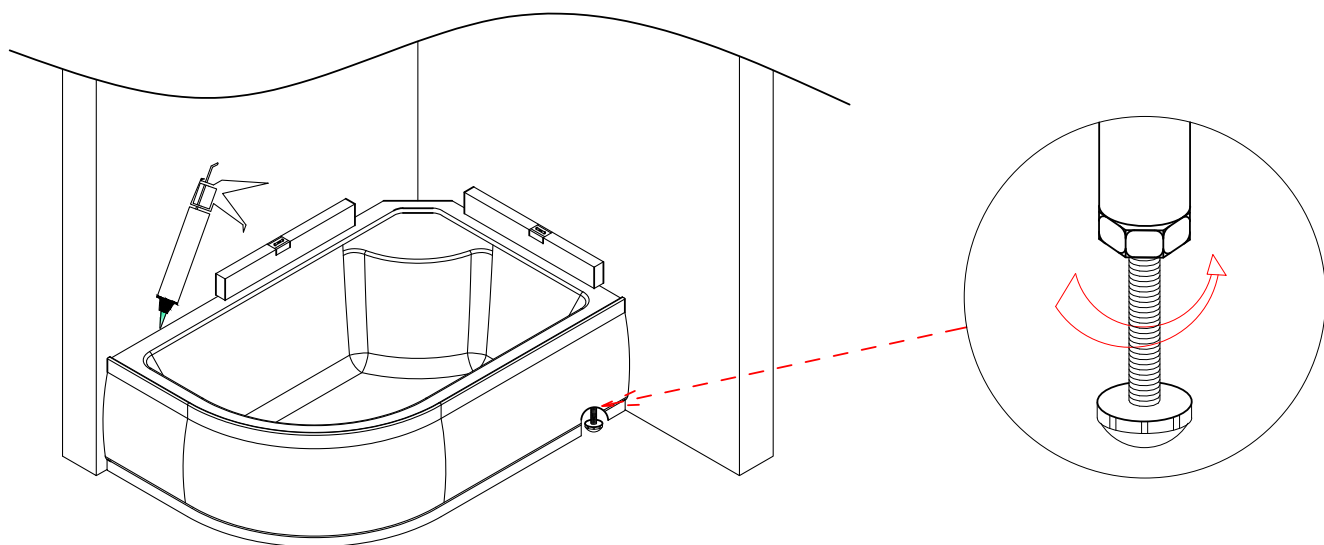
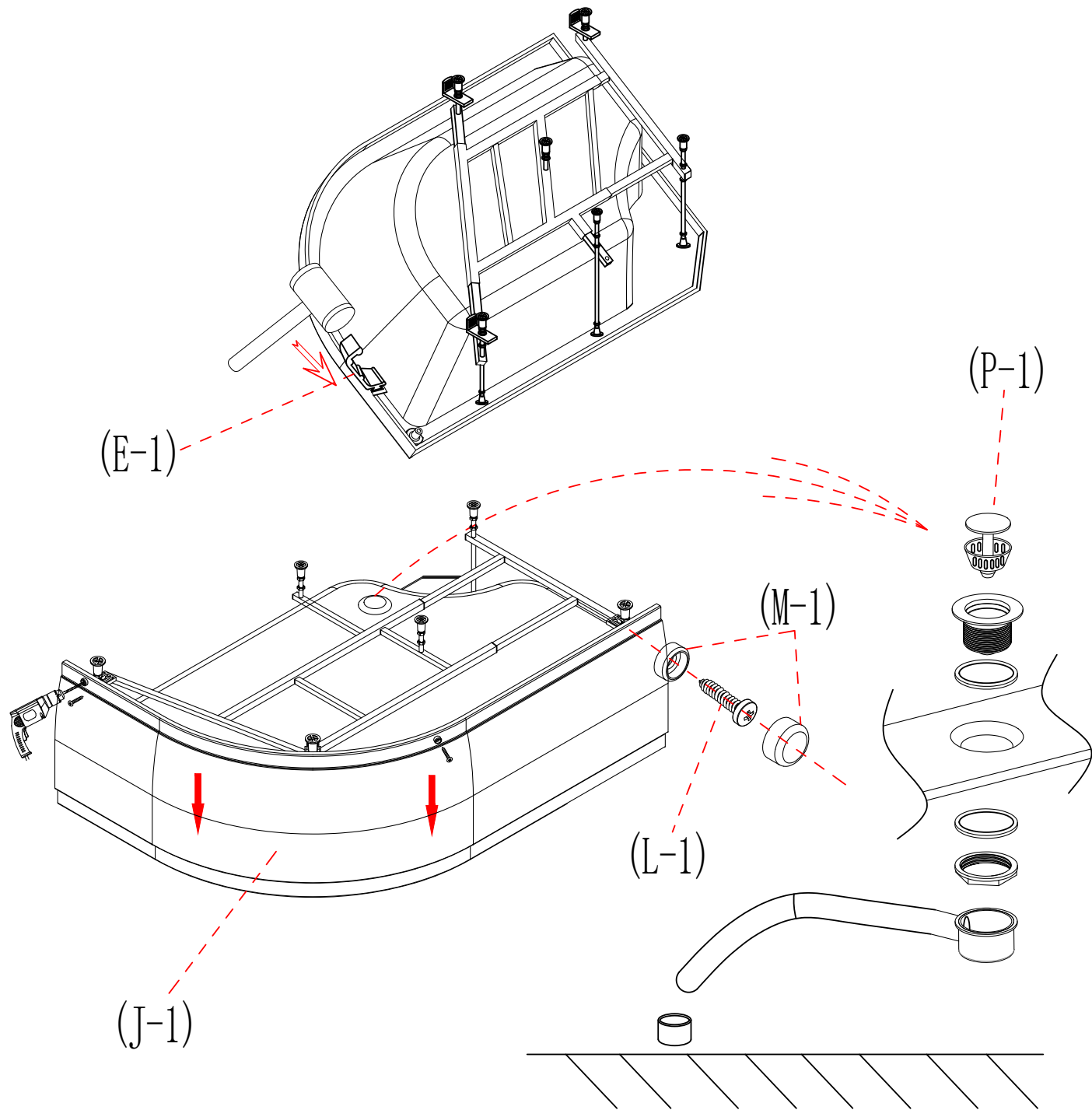

< 2 >

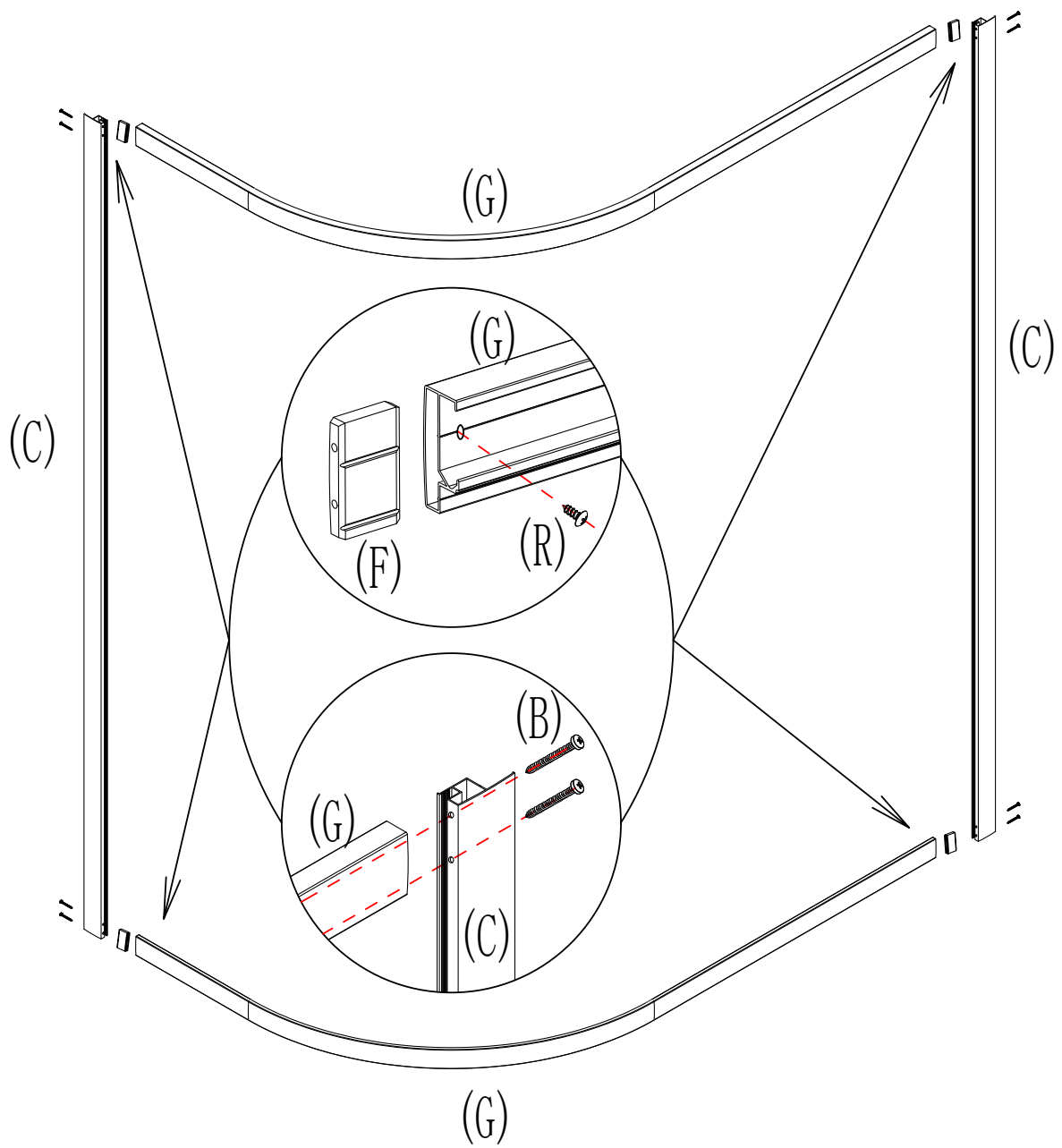

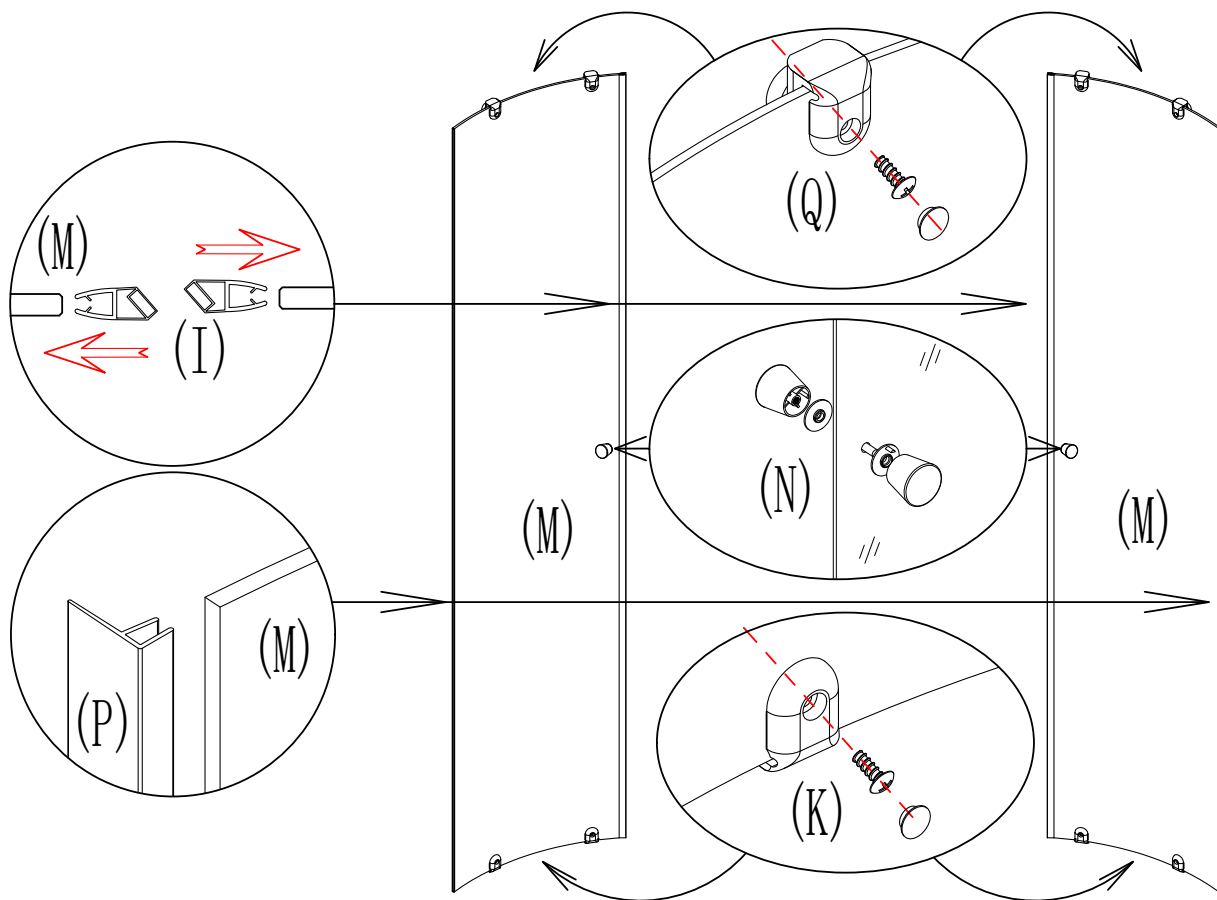
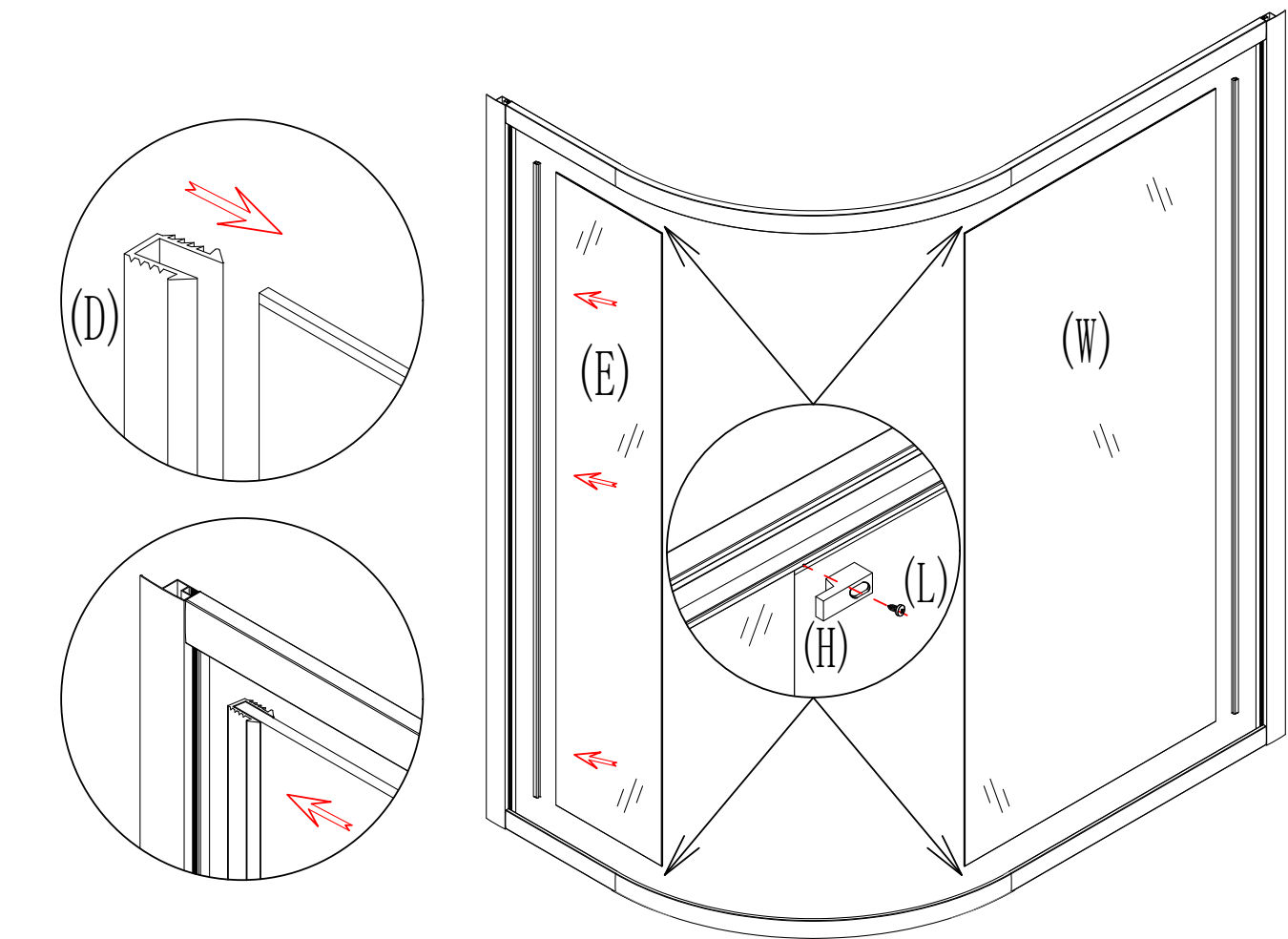

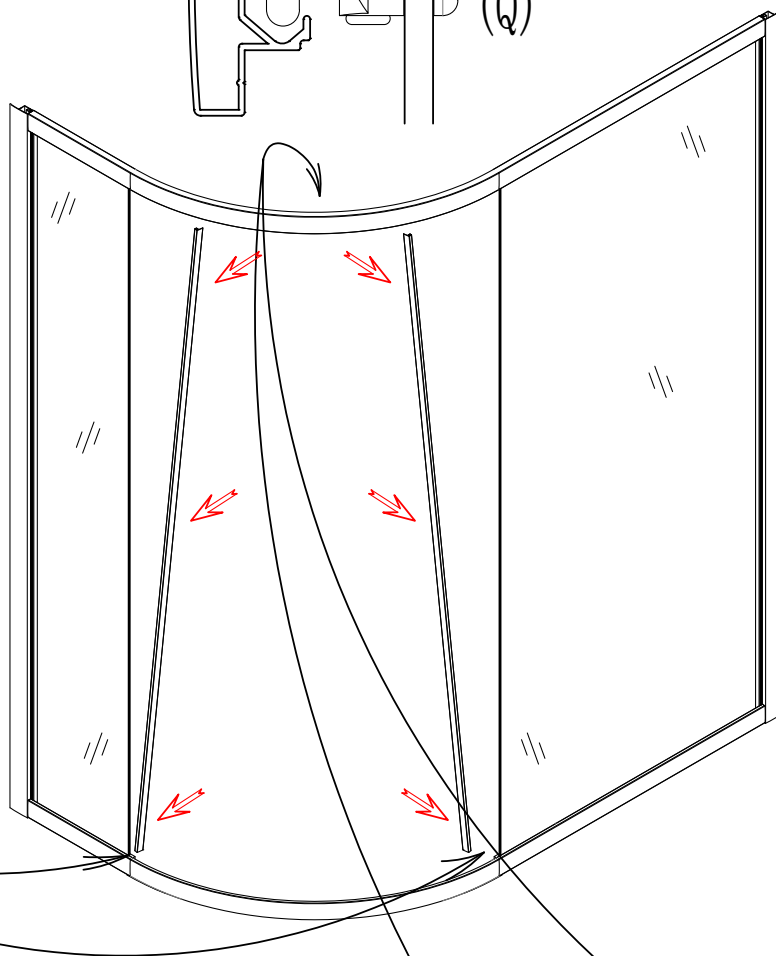
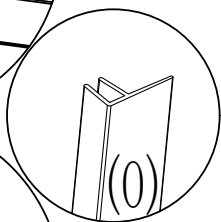
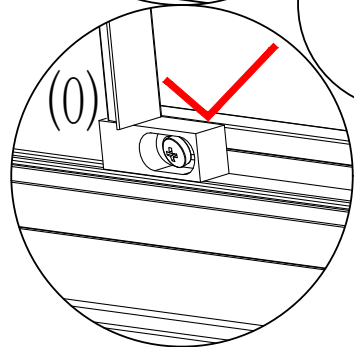
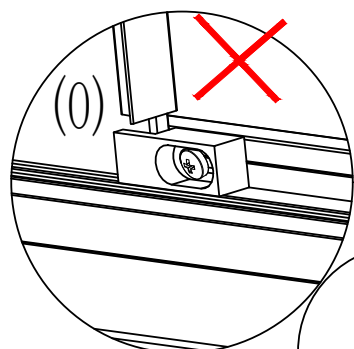

(G)

(Q)

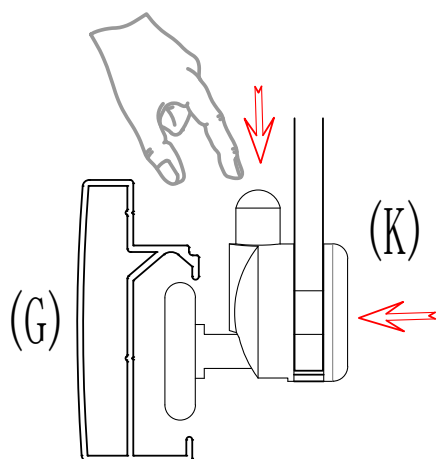

(K)

(G)

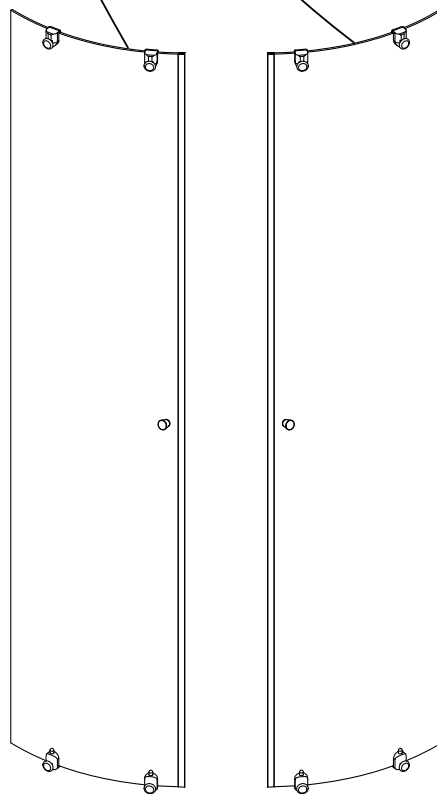

< 5 >

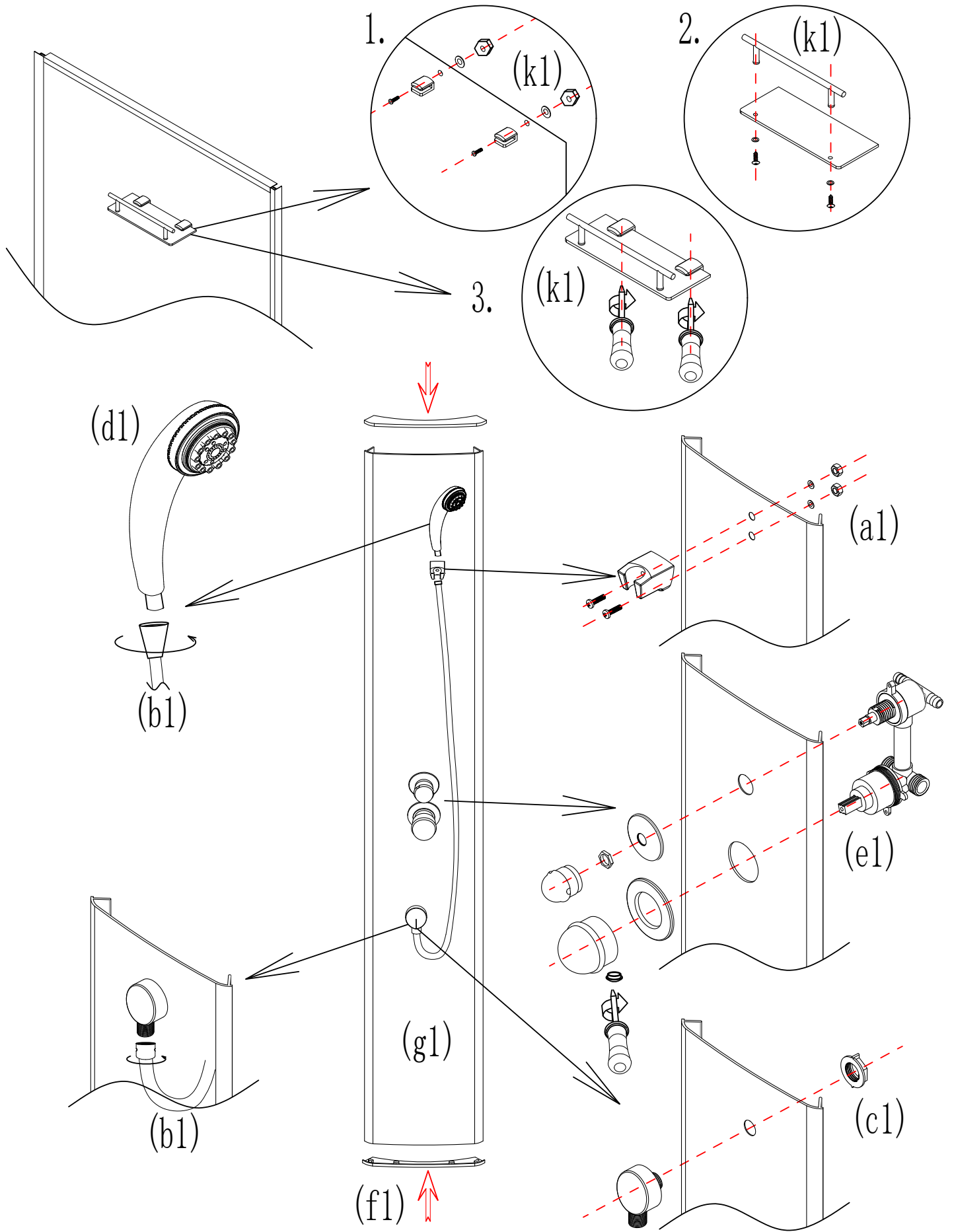

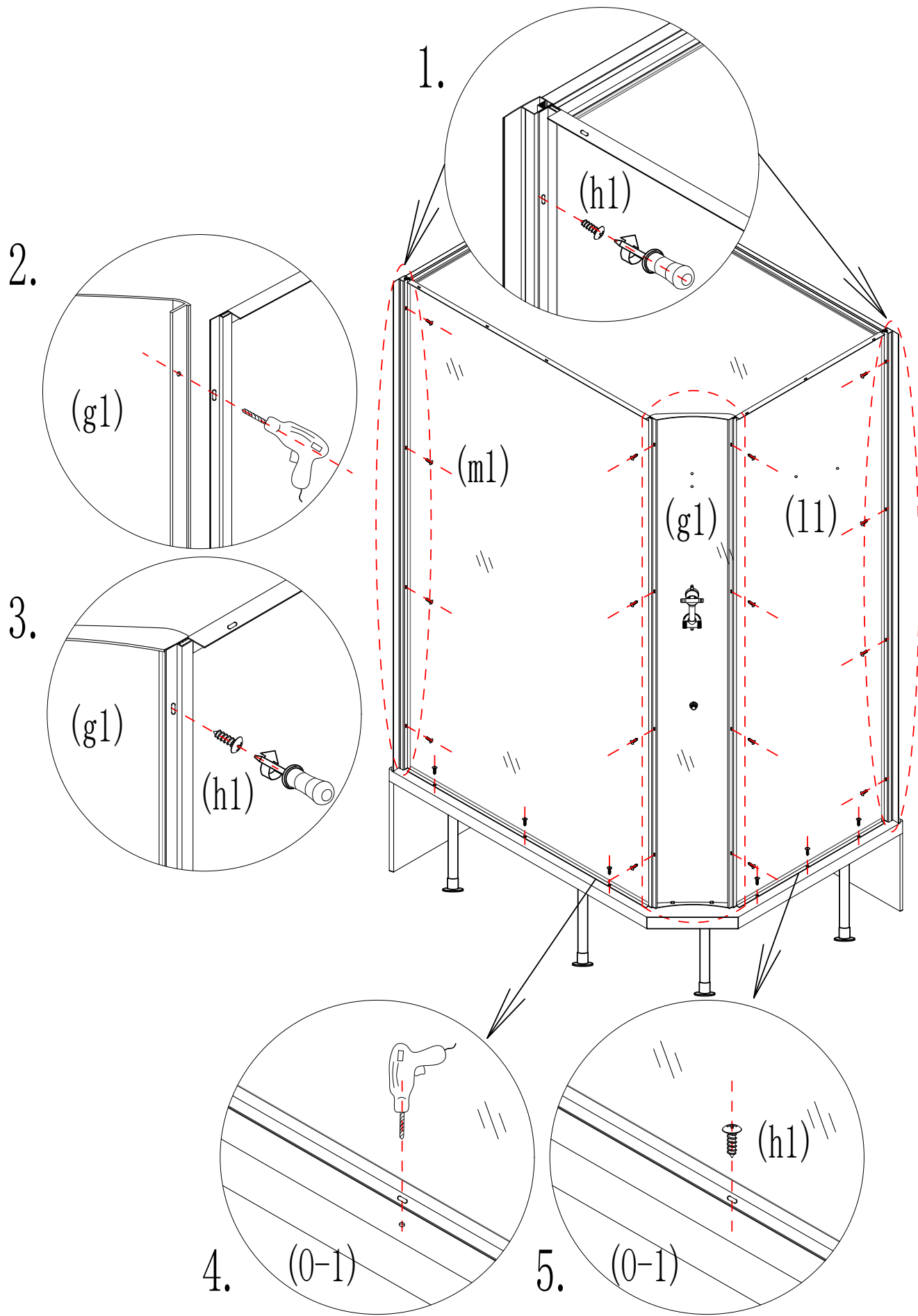

< 7 >

