





















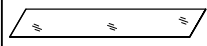

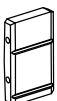

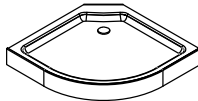
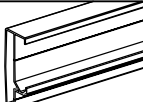



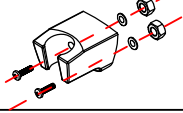

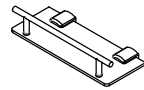

A		8	I		2	Q		4
B	 ST4X40	8	J	 ST4X10	8	R	 ST4X8	4
C		2	K		4	S		1
D		2	L	 ST4X10	4	T		1
E		2	M		2	U		1
F		4	N		2	V		1
G		2	O		2			
H		4	P		2			

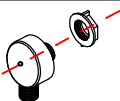
a1		1	f1		2	k1		1
b1		1	g1		1	l1		1
c1		1	h1	 ST4X12	28	m1		1
d1		1	i1		1			
e1		1	j1		2			

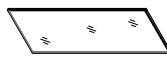

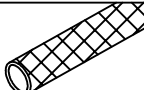
Ø6,Ø2.8

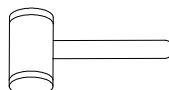
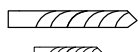
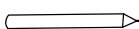
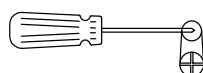
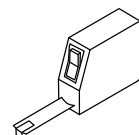
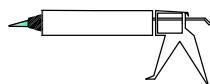
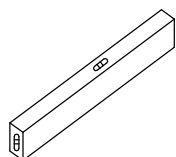
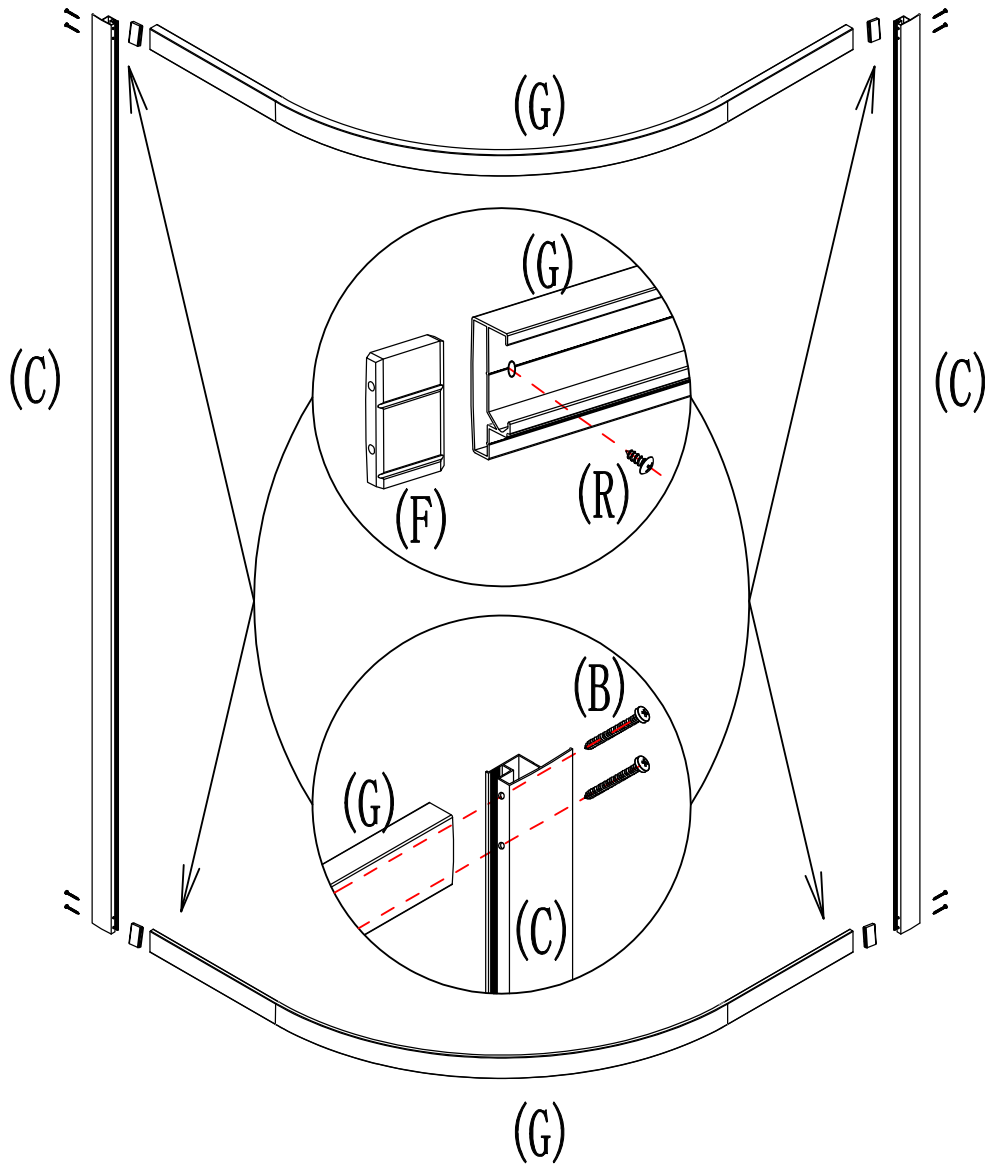
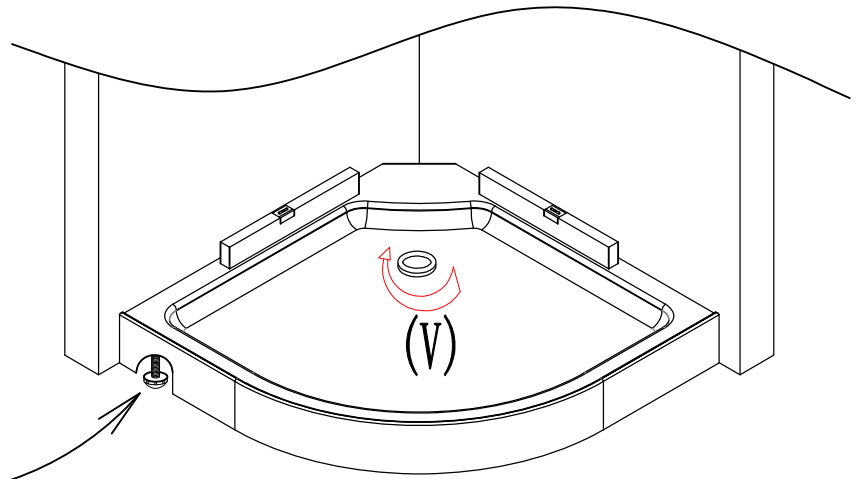
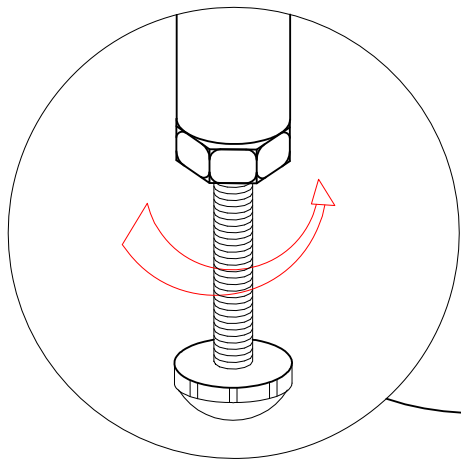

< 1 >

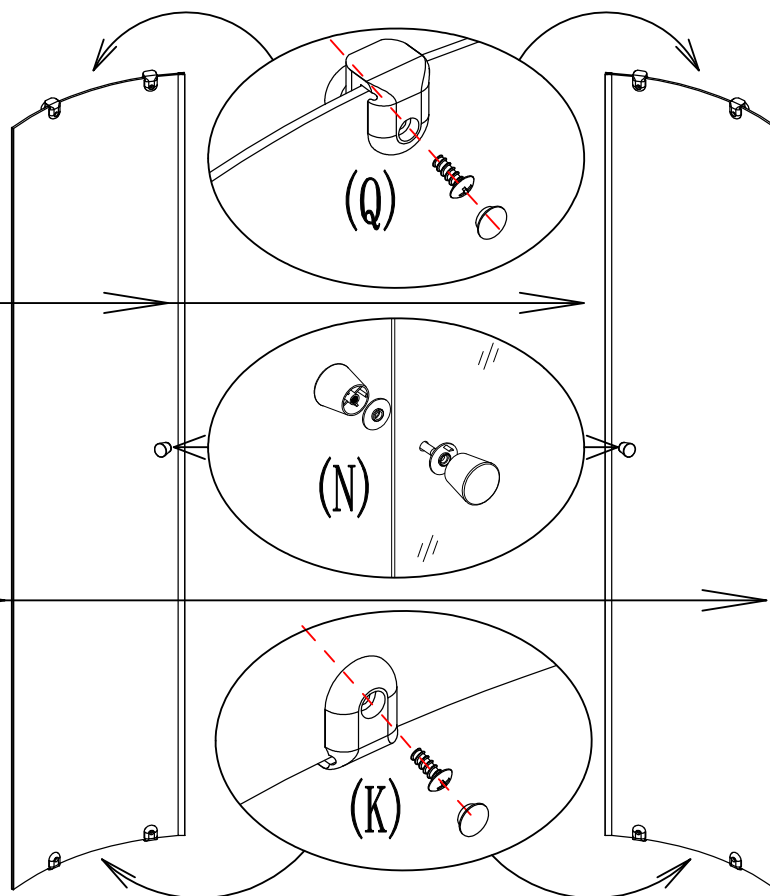
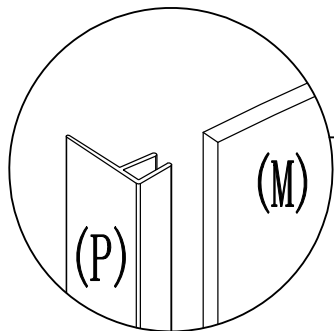
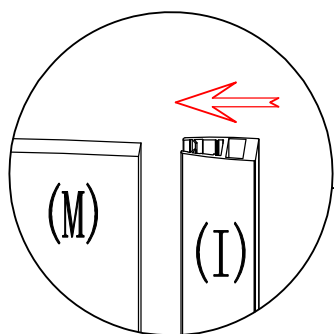
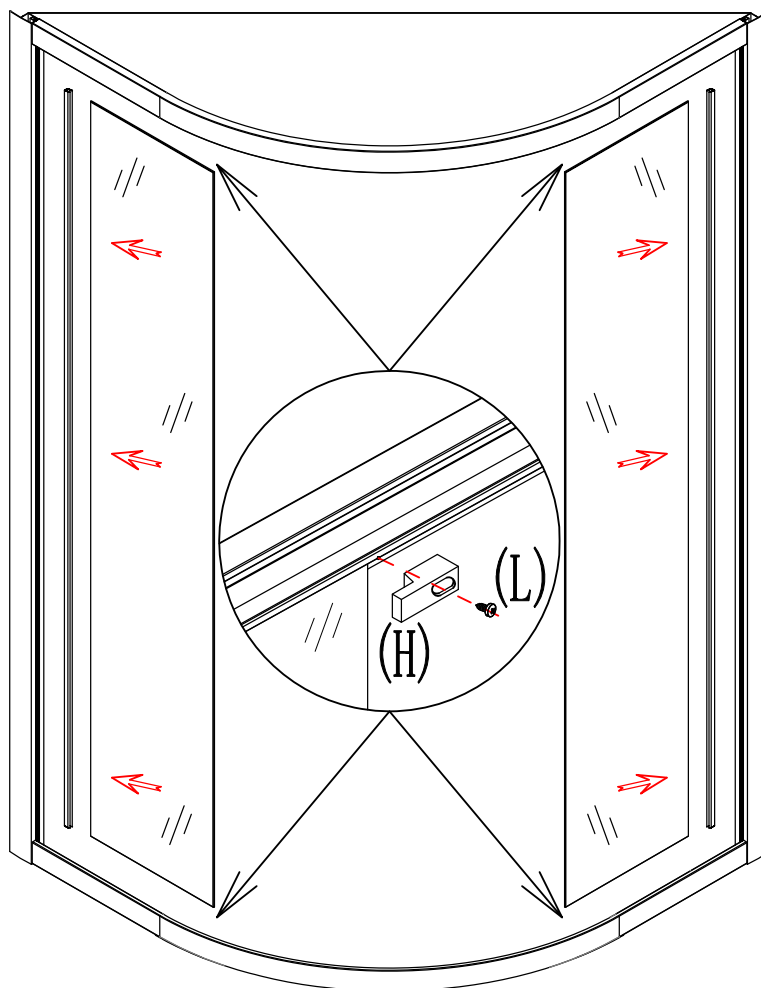
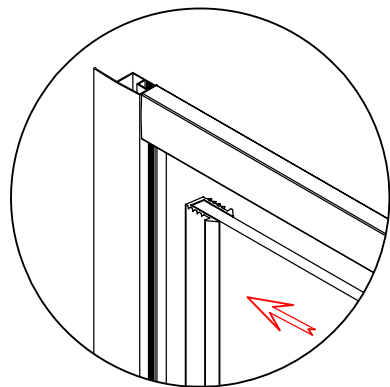
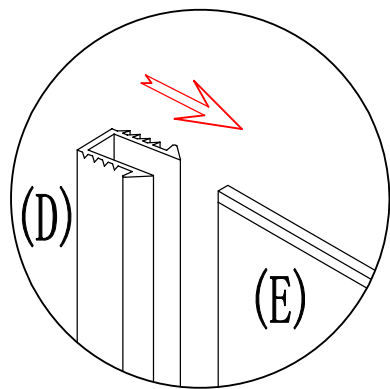

< 2 >

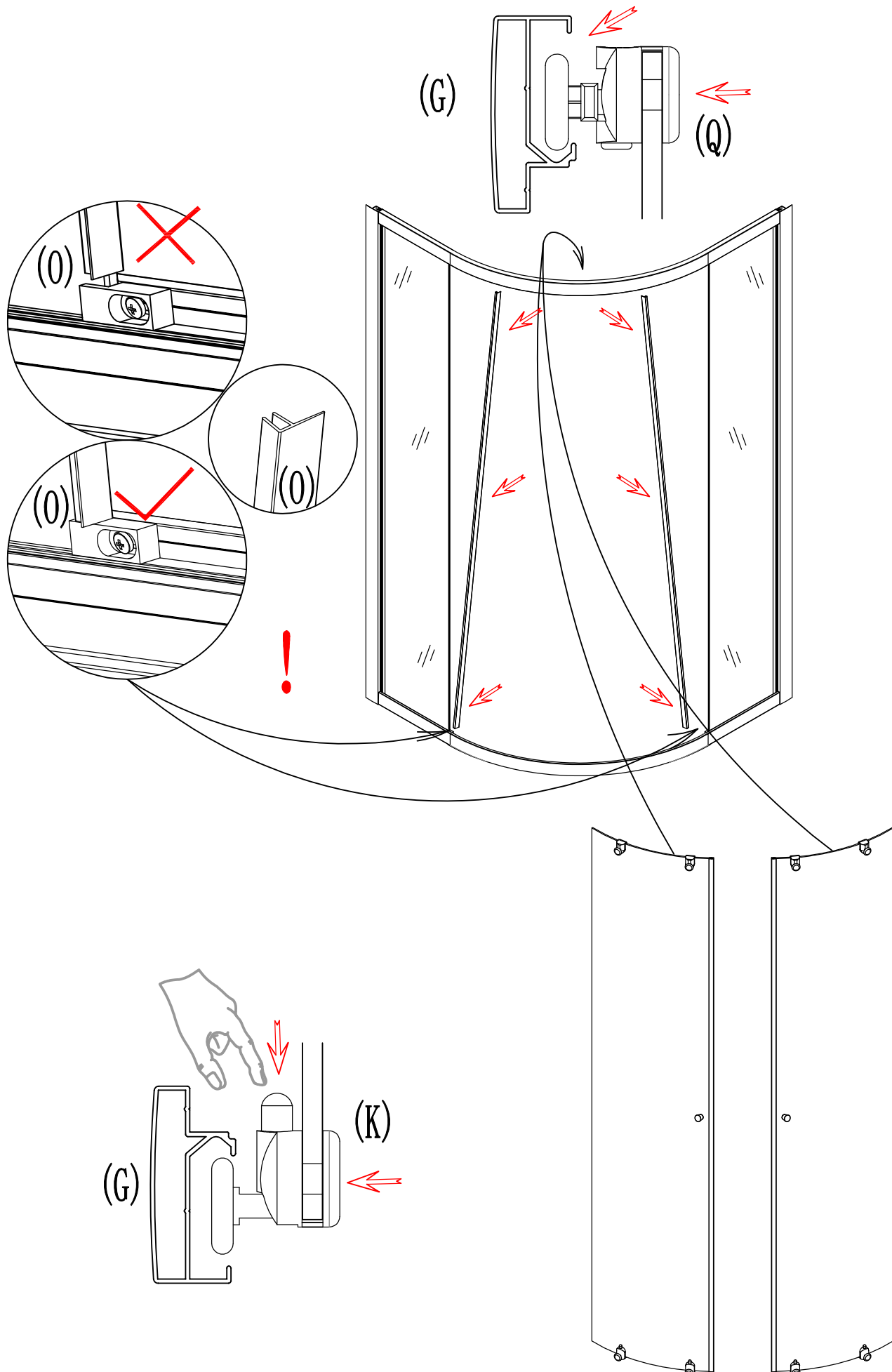

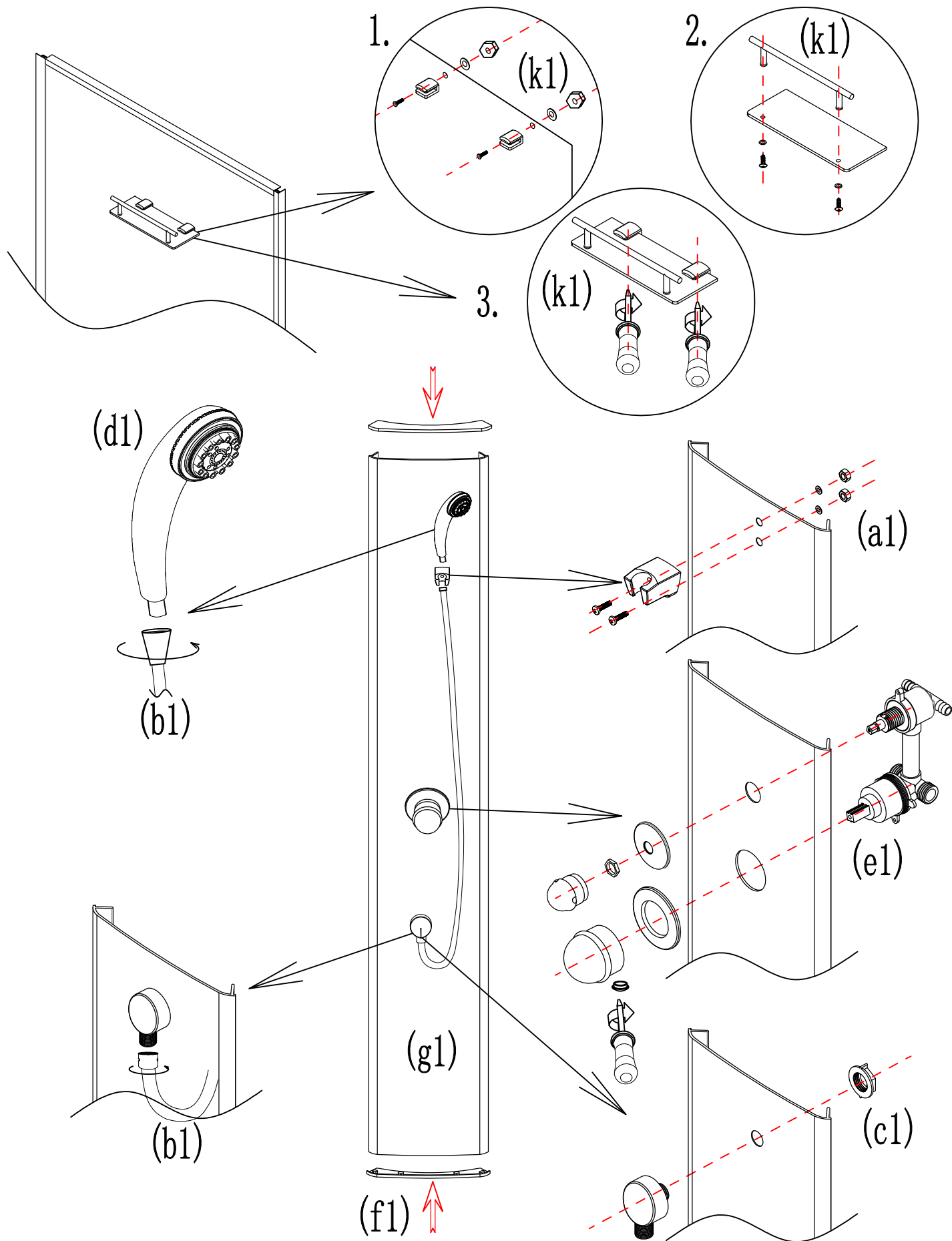

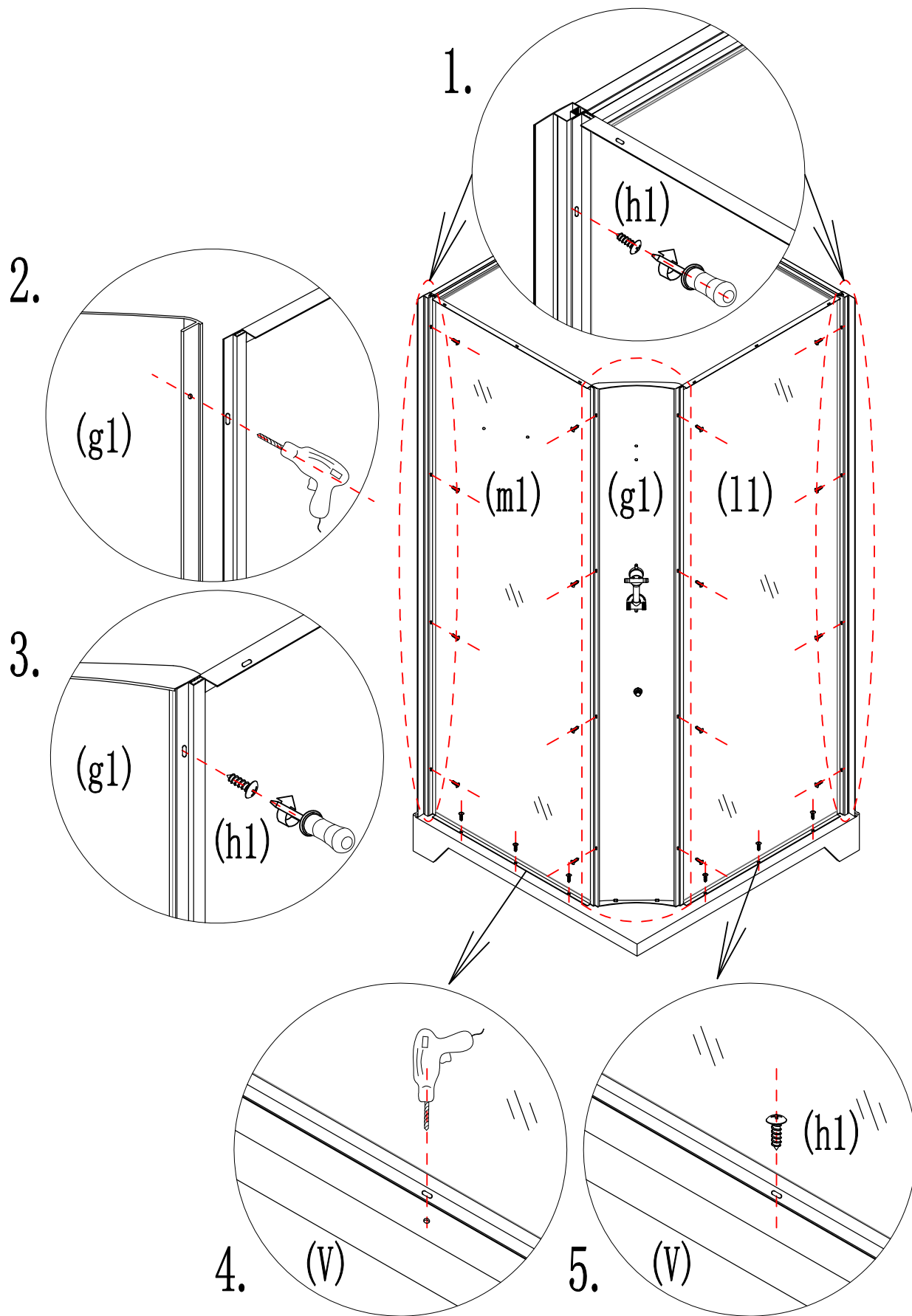

< 5 >

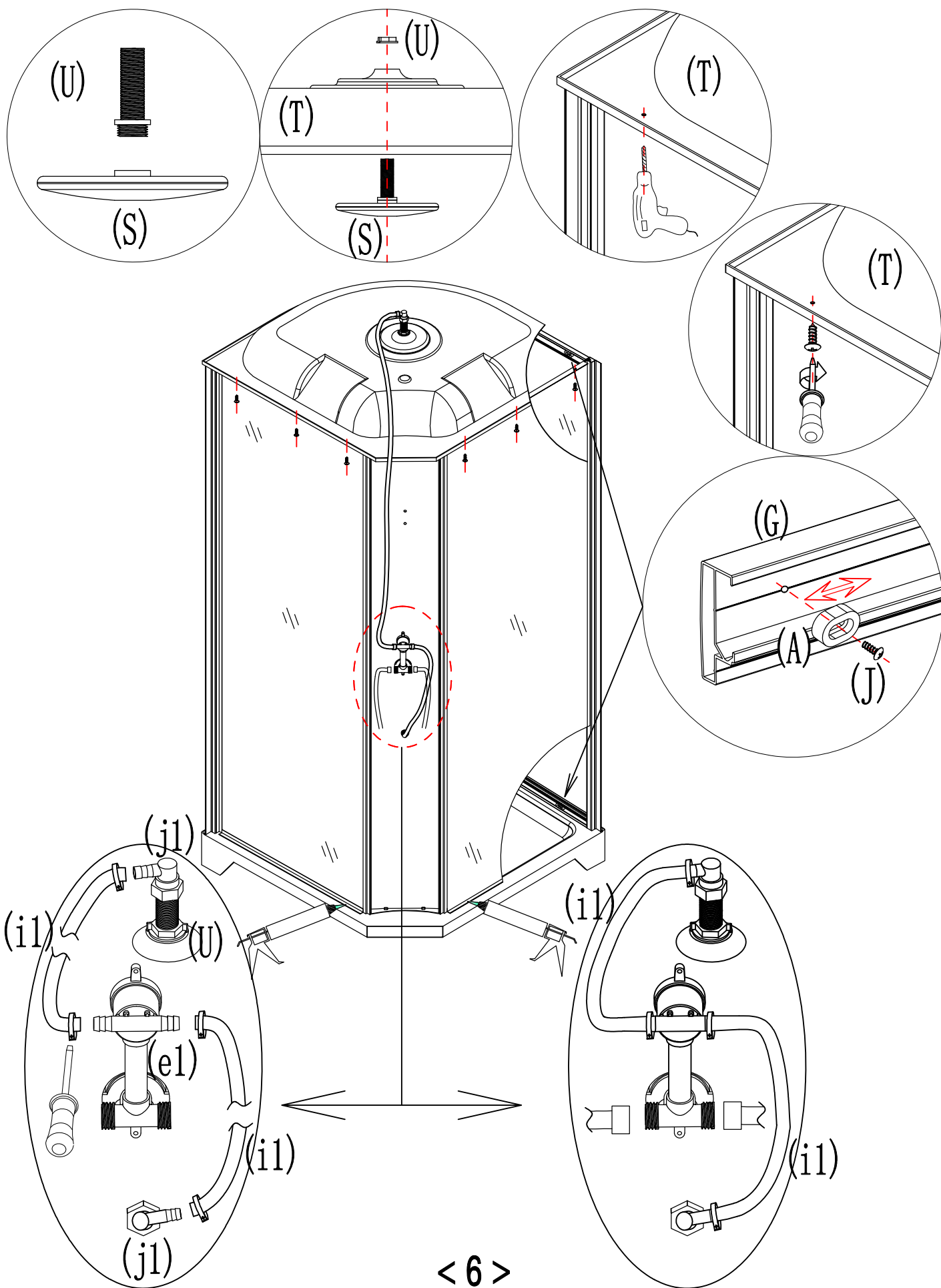

< 6 >

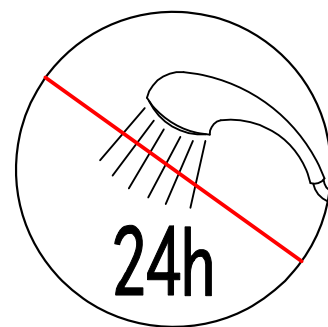
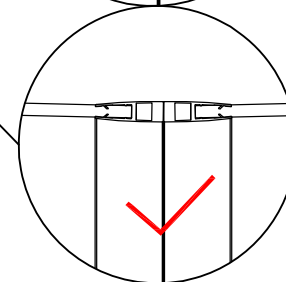
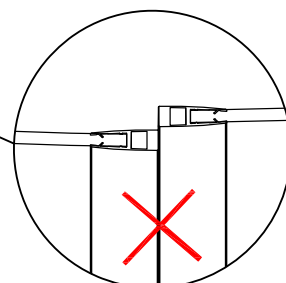
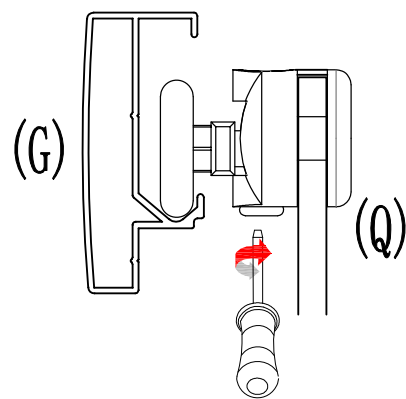
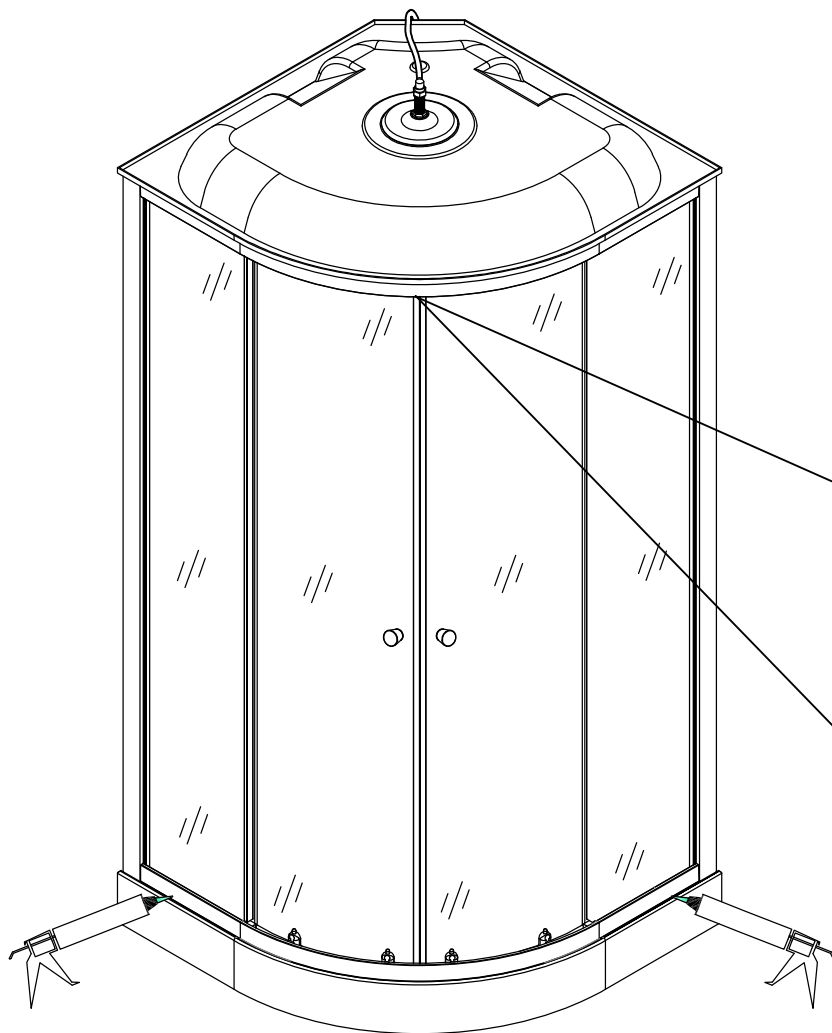

<7>

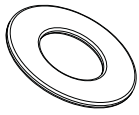

M12=6

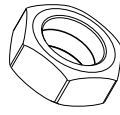

M12=23

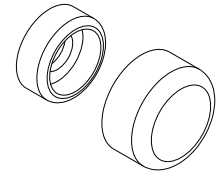

=3

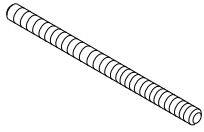

M12 X 10CM=1

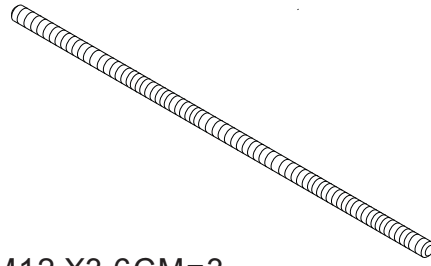

M12 X3 6CM=3

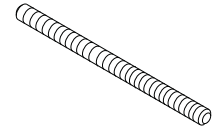

M12 X 18CM=1

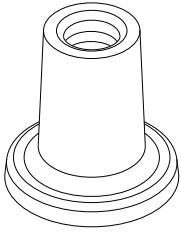

=5

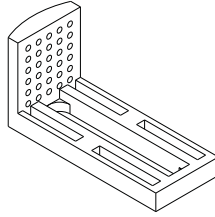

=3

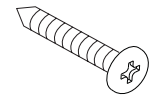

M4 X 20=3

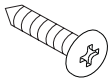

M4 X 12=4

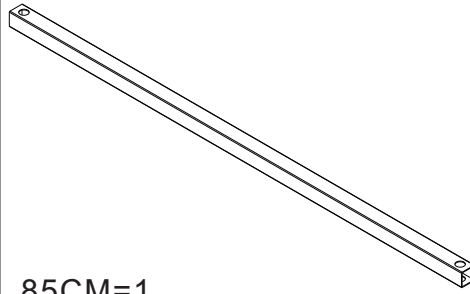

85CM=1

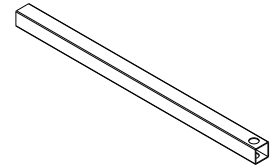

45CM=2

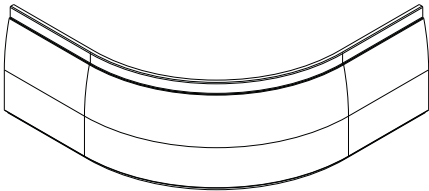

=1

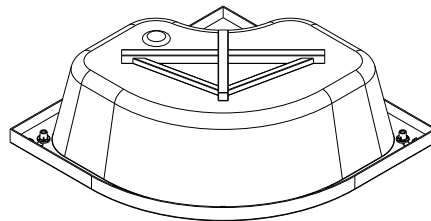

=1

