



# CITY

60384



**WARNING: CHOKING HAZARD.**  
Small parts. Not for children under 3 years.



### **Get excited about our new packaging!**

We're switching from plastic to paper-based packaging. That's why you might find a mix of paper and plastic in our boxes!

### **Nos nouveaux emballages vous emballeront !**

Nous passons des emballages en plastique aux emballages à base de papier. C'est pourquoi vous pourriez trouver un mélange de papier et de plastique dans nos boîtes !

### **¡Te presentamos nuestros nuevos empaques!**

Estamos sustituyendo las bolsas de plástico por bolsas con base de papel. ¡Por eso, puedes encontrar una mezcla de papel y de plástico en nuestras cajas!

**[LEGO.com/sustainable-packaging](https://www.lego.com/sustainable-packaging)**



# BUILDER



Apple and the Apple logo are trademarks of Apple Inc., registered in the U.S. and other countries and regions. App Store is a service mark of Apple Inc. Google Play and the Google Play logo are trademarks of Google LLC. Tencent and the Tencent logo are trademarks of Tencent Inc.

[LEGO.com/devicecheck](https://www.lego.com/devicecheck)

**EN** Ask parents' permission before going online | **DE** Eltern um Erlaubnis bitten, bevor du online gehst | **FR** Demande l'autorisation d'un parent avant d'aller en ligne | **IT** Chiedi il permesso ai tuoi genitori prima di andare online | **ES** Pídeles permiso a tus papás antes de conectarte a Internet | **PT** Pede autorização aos pais antes de acederes online | **JA** オンラインになる前に ほご者の方のきよかをもらおう | **ZH** 上网前应先征得父母的同意 | **KO** 온라인 접속 전에 보호자 동의가 필요합니다 | **RU** Спроси разрешения у родителей, прежде чем заходить в интернет | **PL** Poproś rodziców o zgodę, zanim wejdziesz do Internetu | **CS** Než půjdeš na internet, požádej rodiče o svolení | **SK** Skôr než pôjdeš na internet, vypýtaj si povolenie od rodičov | **HU** Kérj szülői engedélyt, mielőtt online csatlakoznál! | **RO** Cere permisiunea părinților înainte de a te conecta online | **BG** Поискайте разрешение от родител, преди да влезете онлайн | **LV** Pirms došanās tiešsaistē palūdz atļauju vecākiem | **ET** Enne Interneti kasutamist küsi vanematelt luba | **LT** Prieš prisijungdami prie interneto, atsklauskite tėvų



## AVERTISSEMENT :

RISQUE

D'ÉTOUFFEMENT.

Contient des petites pièces.  
Ne convient pas aux enfants  
de moins de 3 ans.



## ADVERTENCIA:

PELIGRO DE ASFIXIA.

No recomendado para  
niños menores de 3 años.  
Contiene piezas pequeñas.



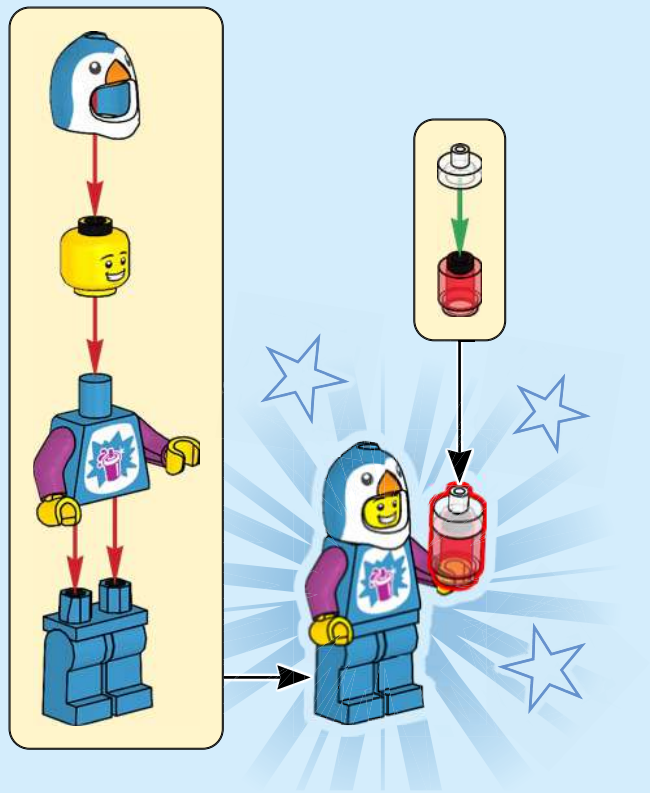

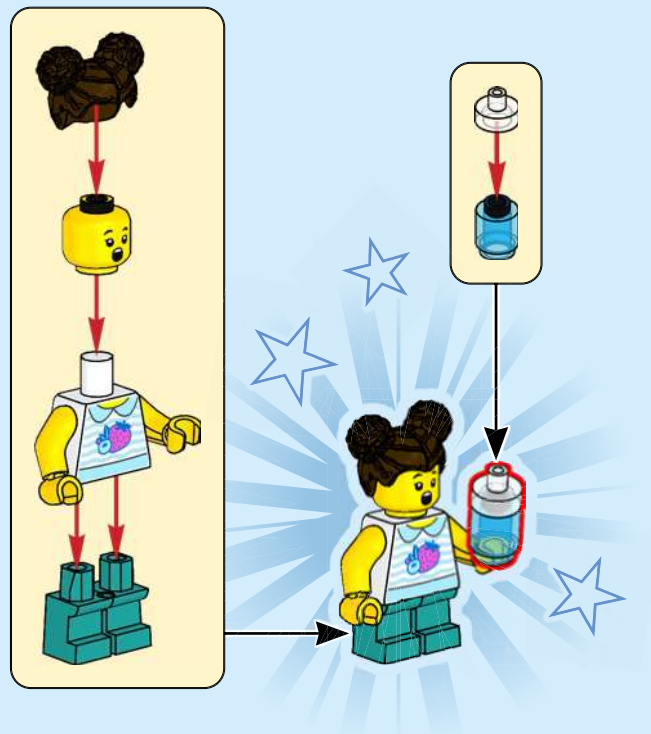

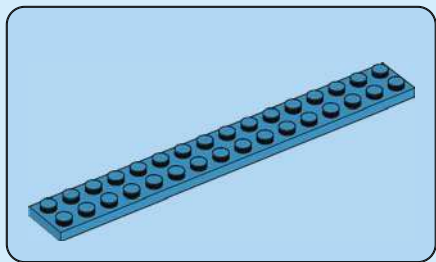

1

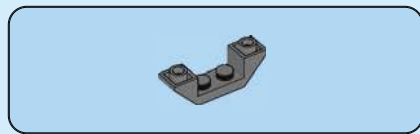
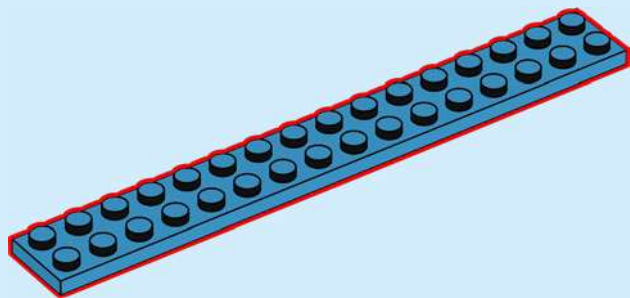

2

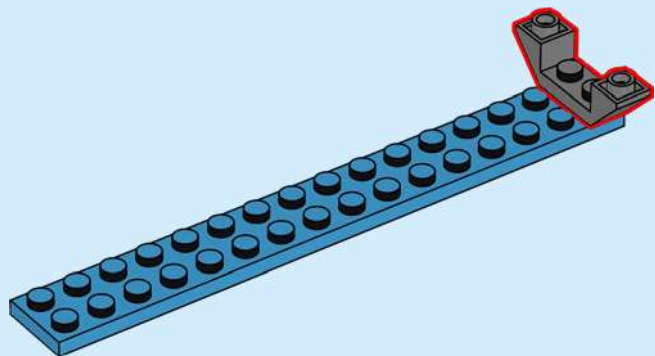



3

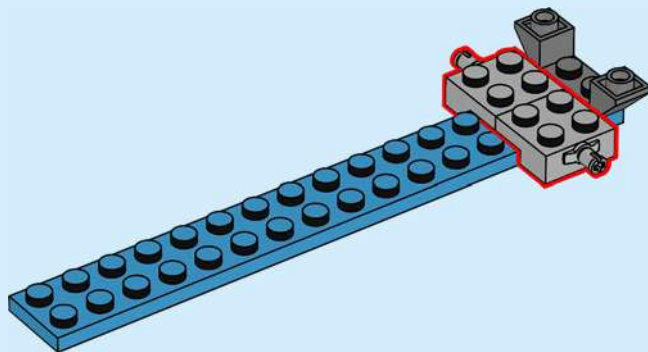



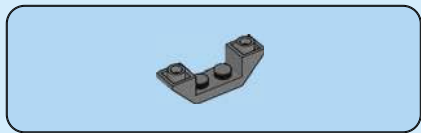

4

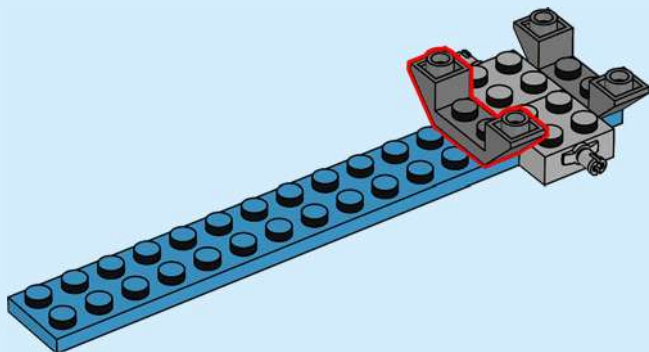

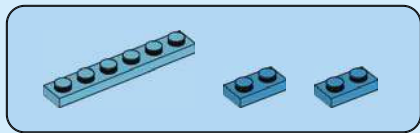

5

1

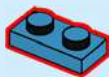

2

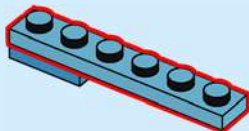

3

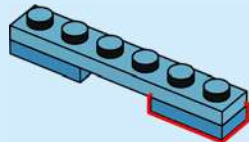

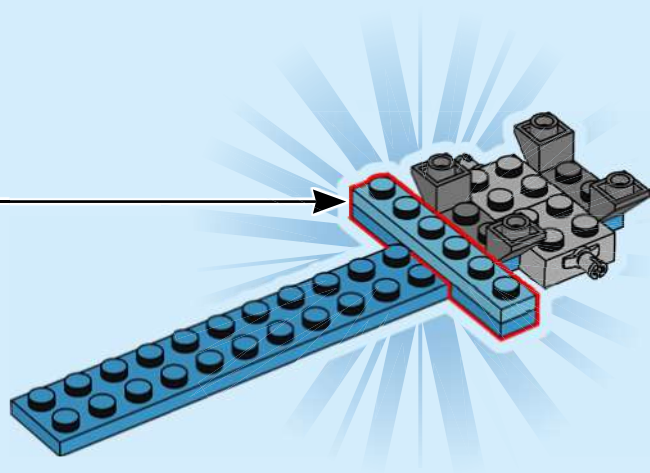

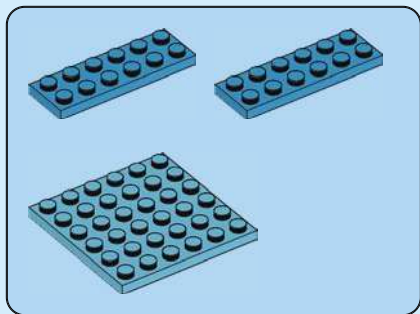

6

1

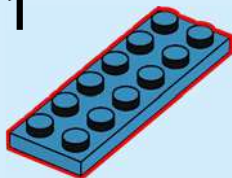

2

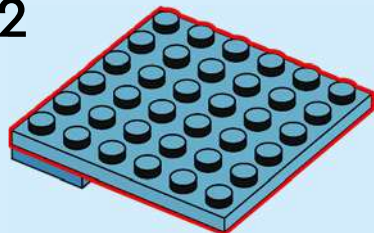

3

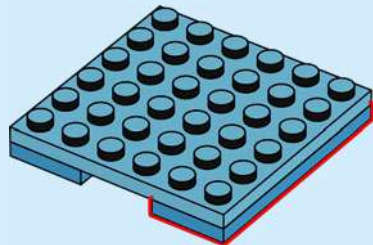

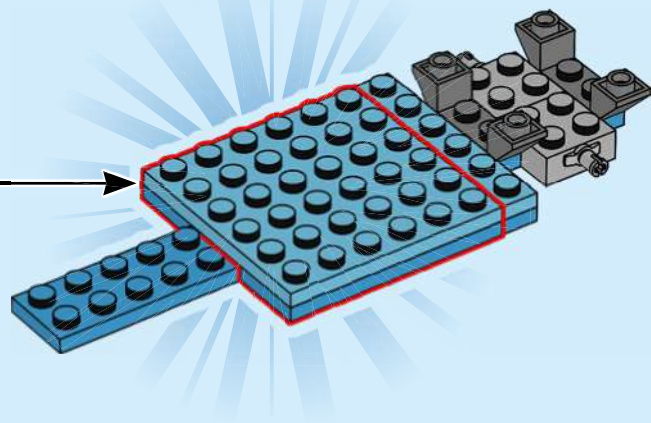

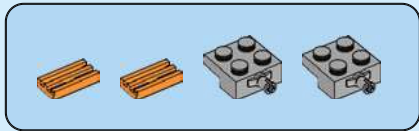

7

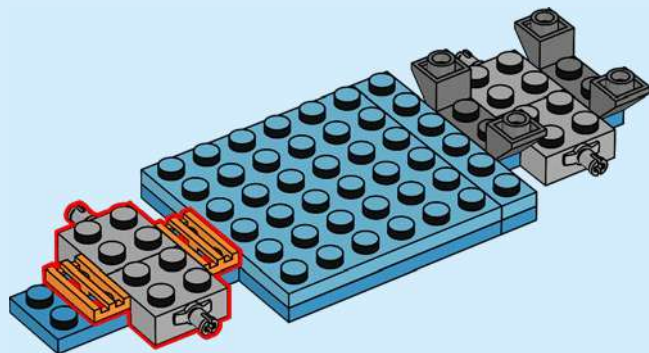

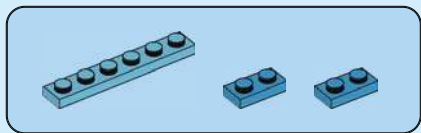

8

1

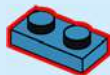

2

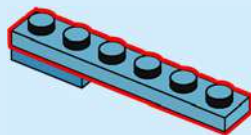

3

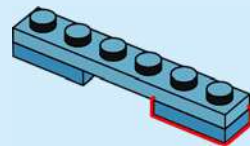

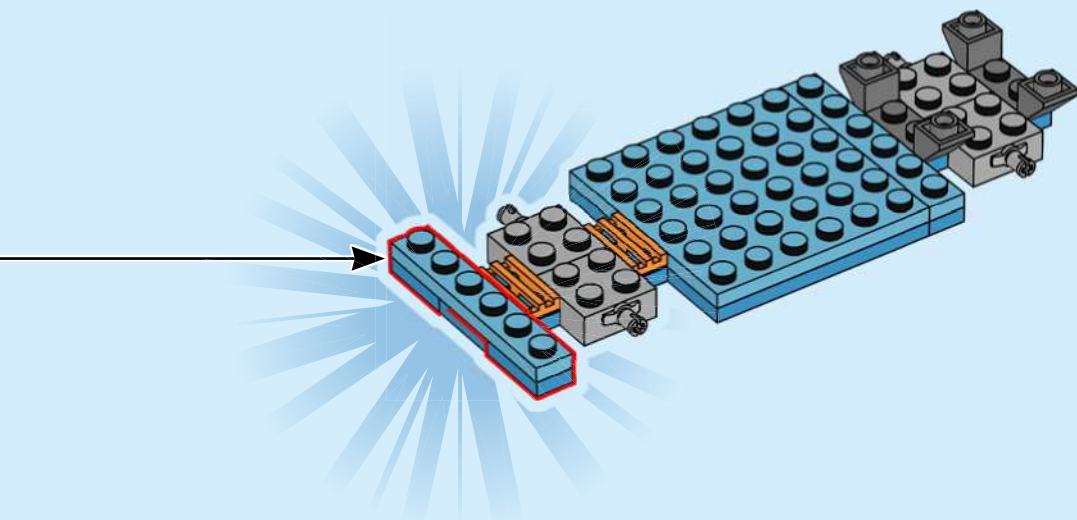



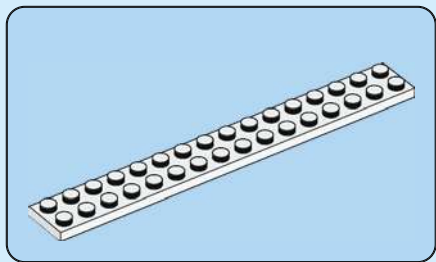

9

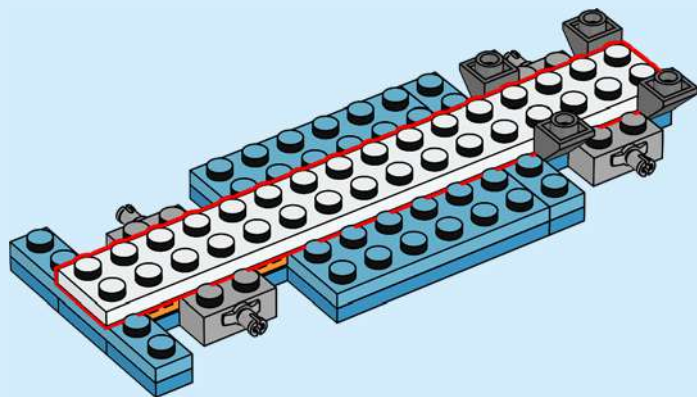



10

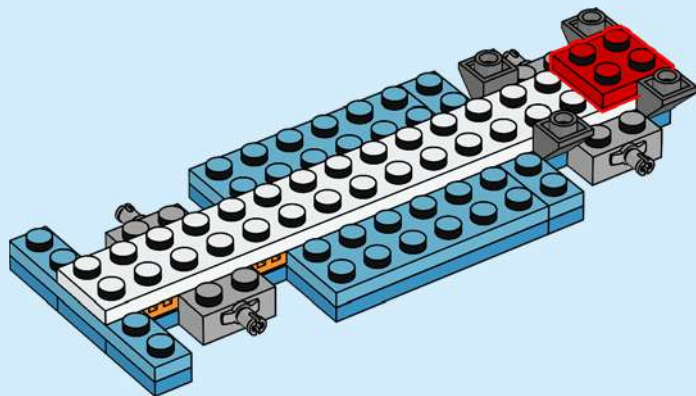

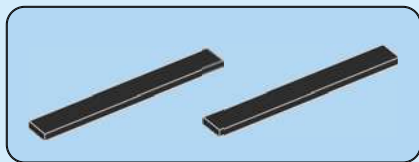

11

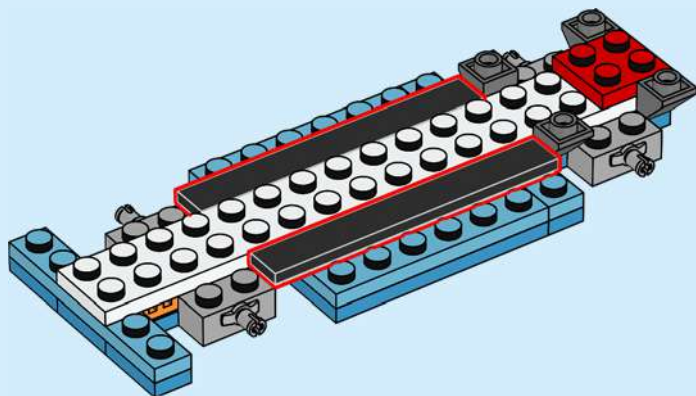

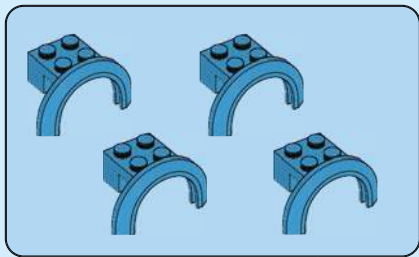

12

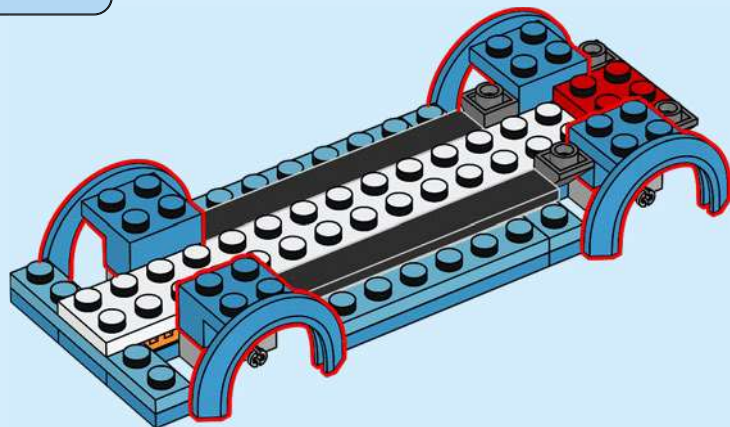

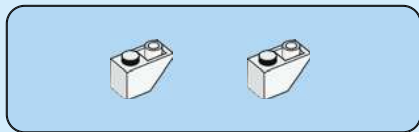

13

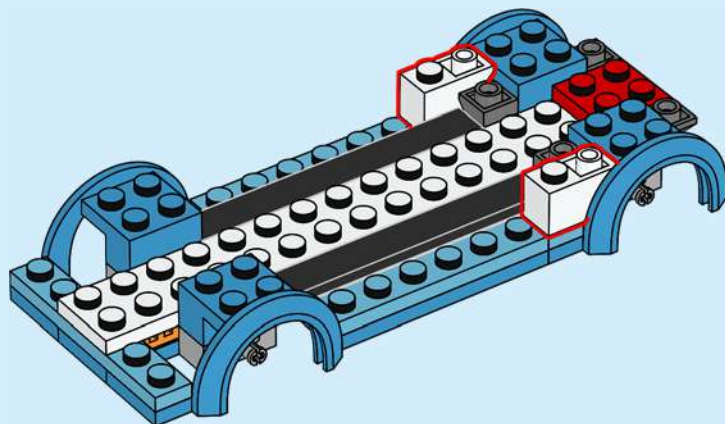

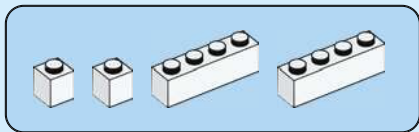

14

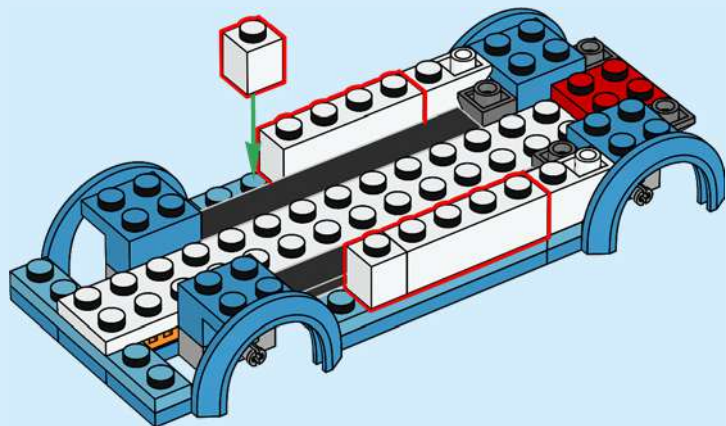

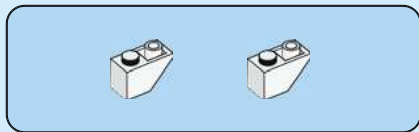

15

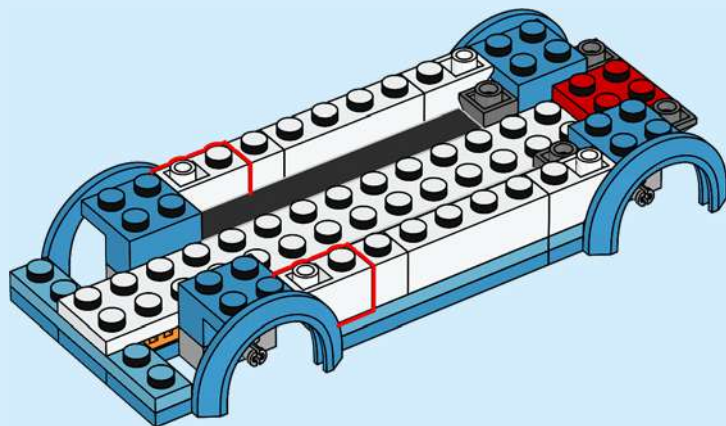



16

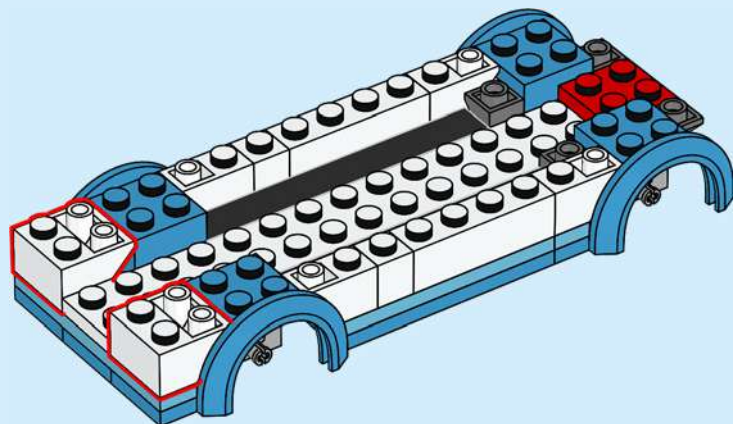



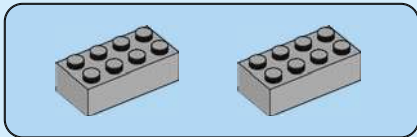

17

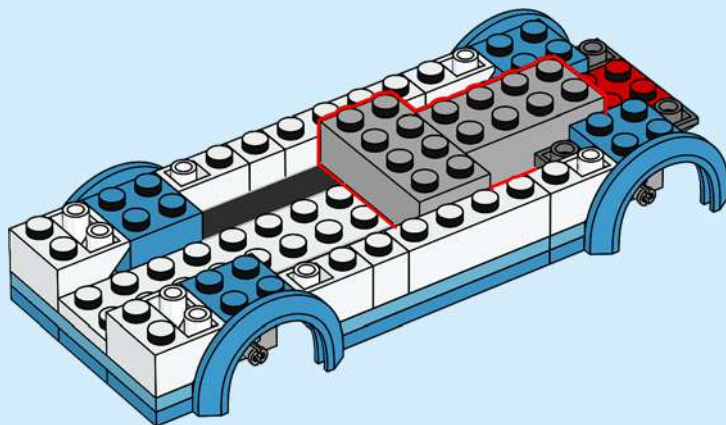

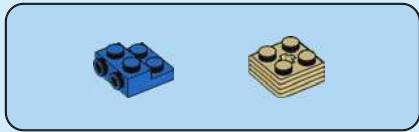

18

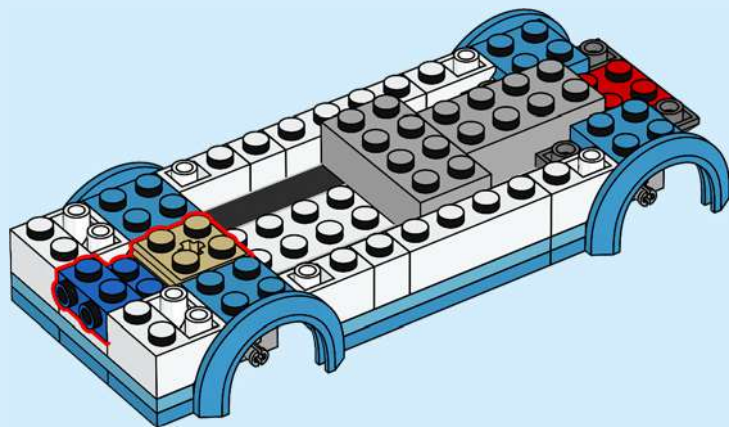

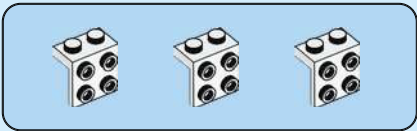

19

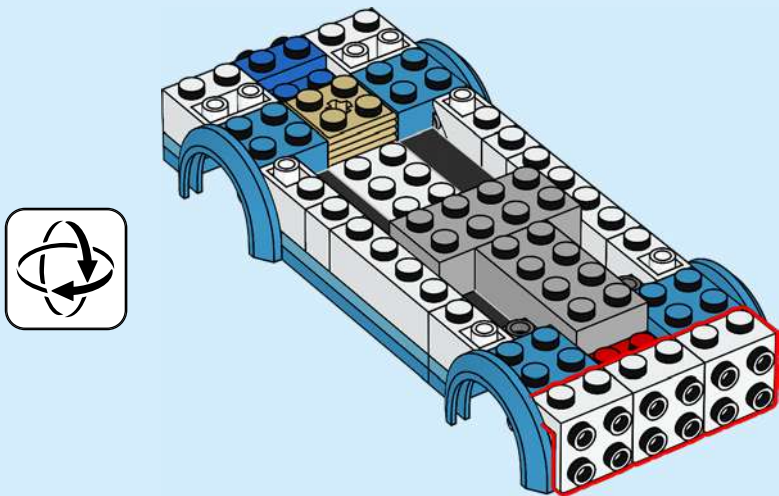

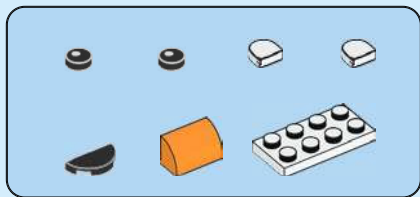

20

1



2



3



4

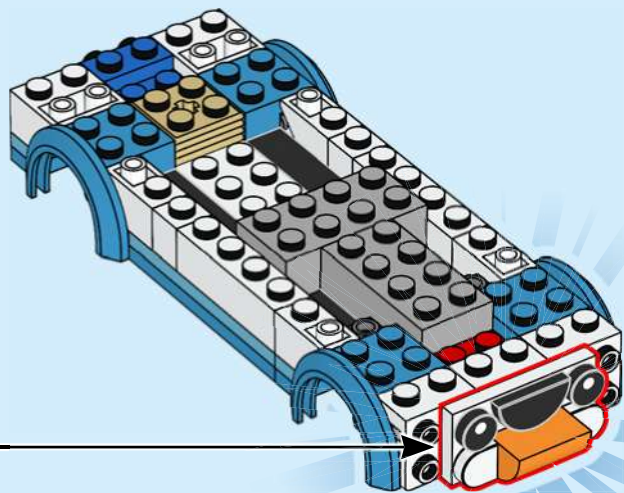

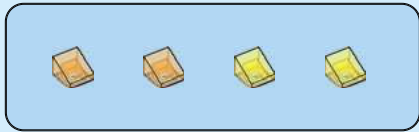

21

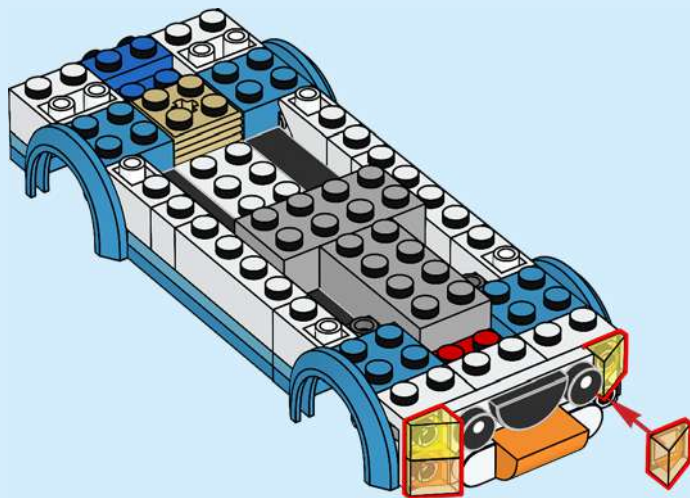

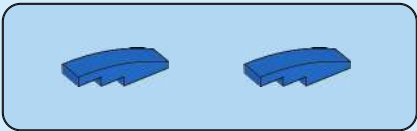

22

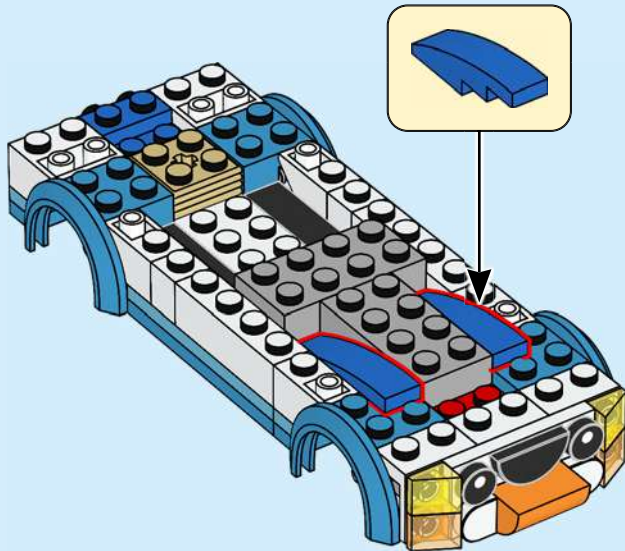



23

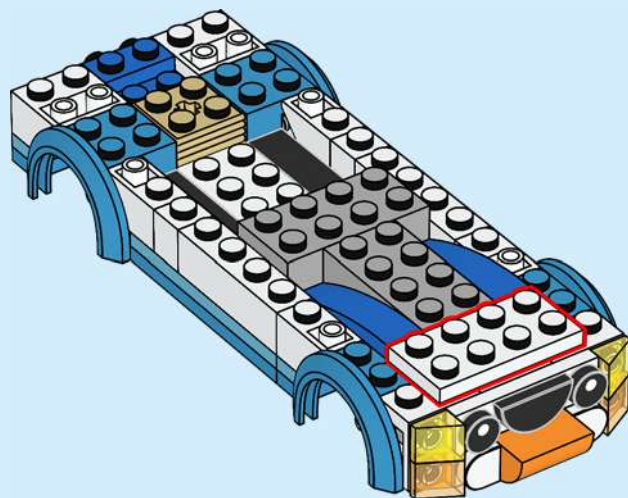





24

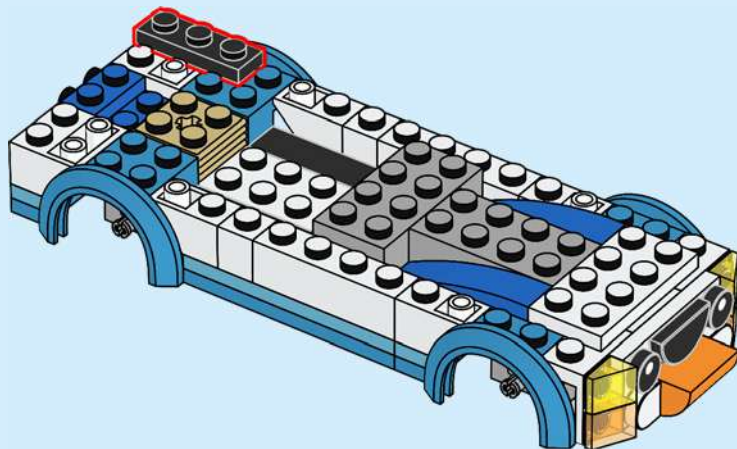



25

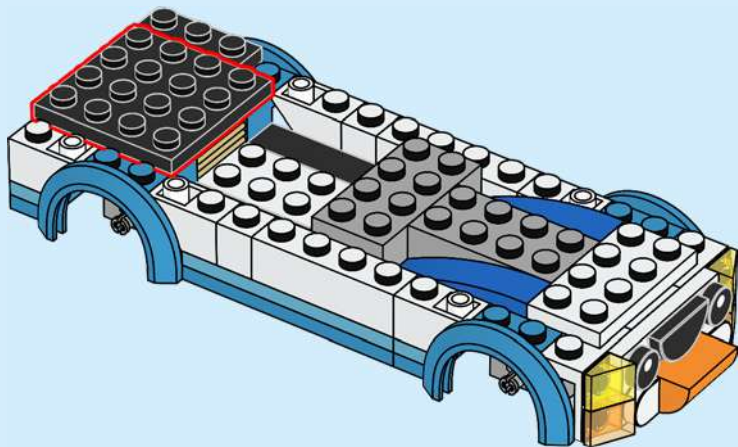



26

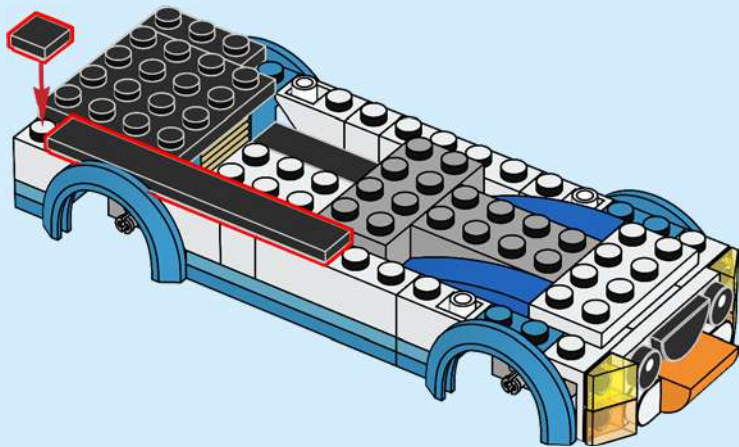

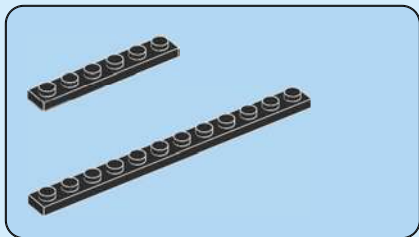

27

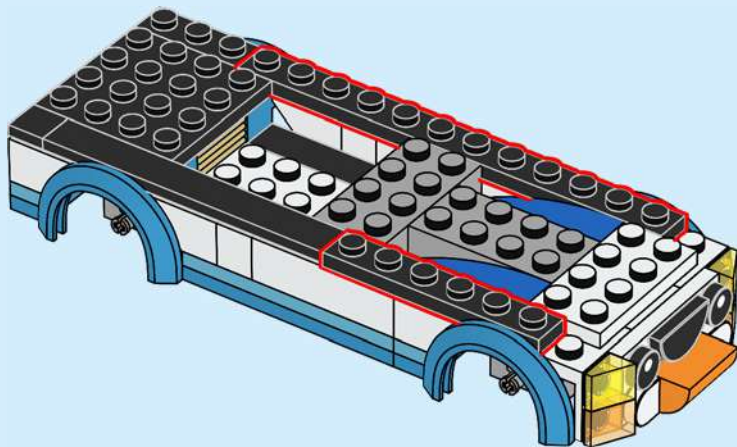

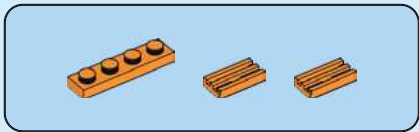

28

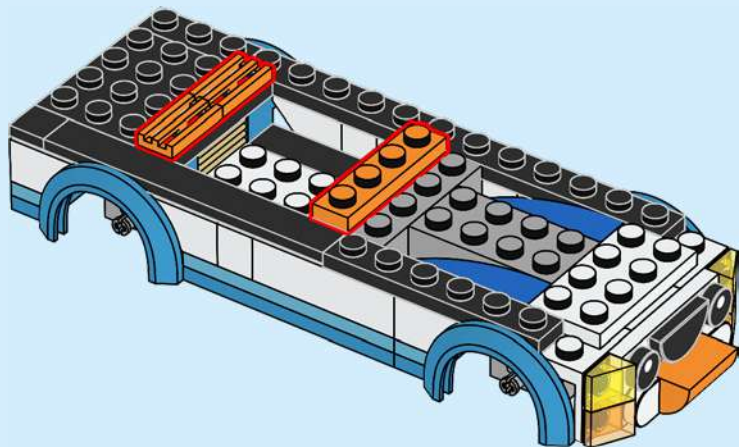

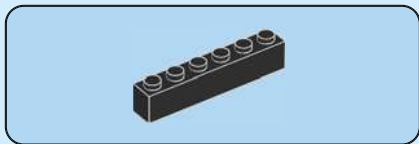

29

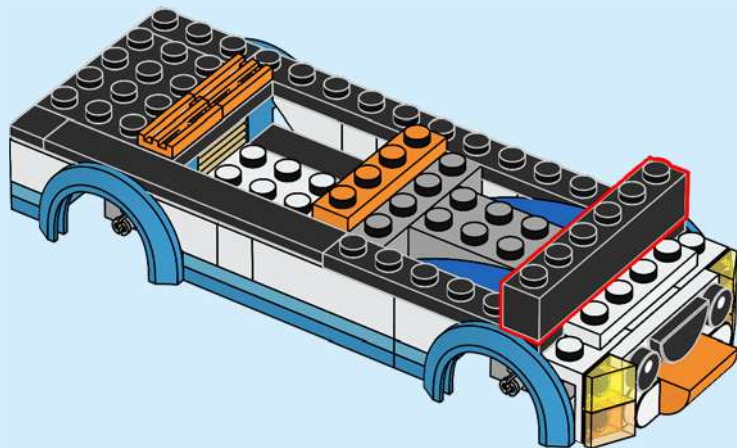



30

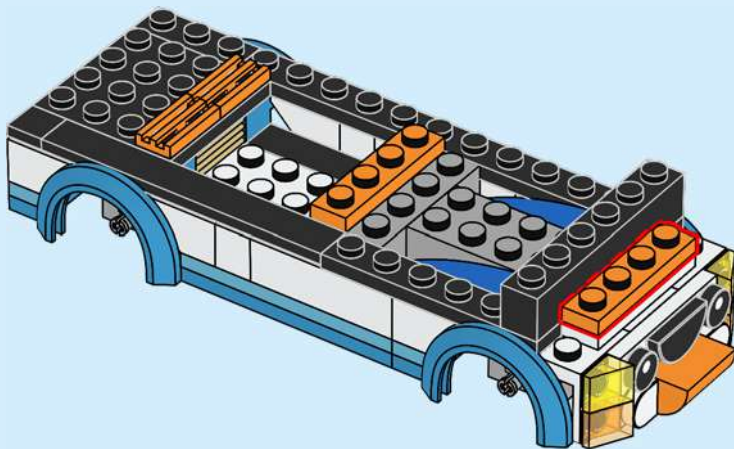



31

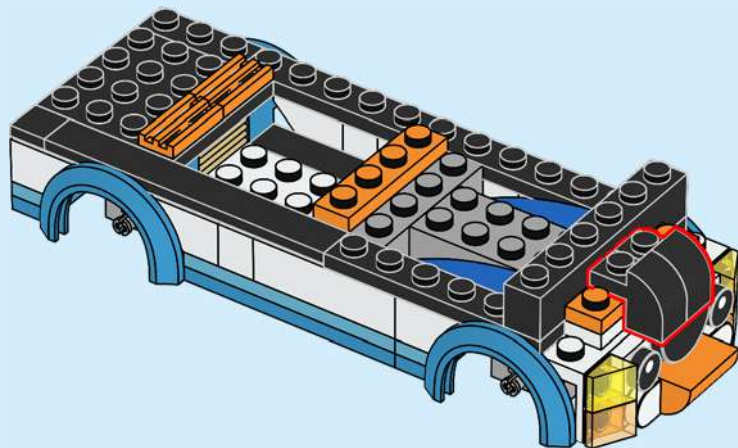





32

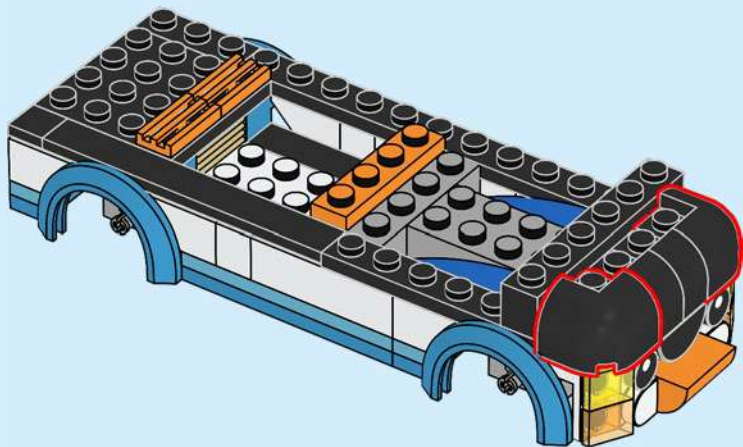



33

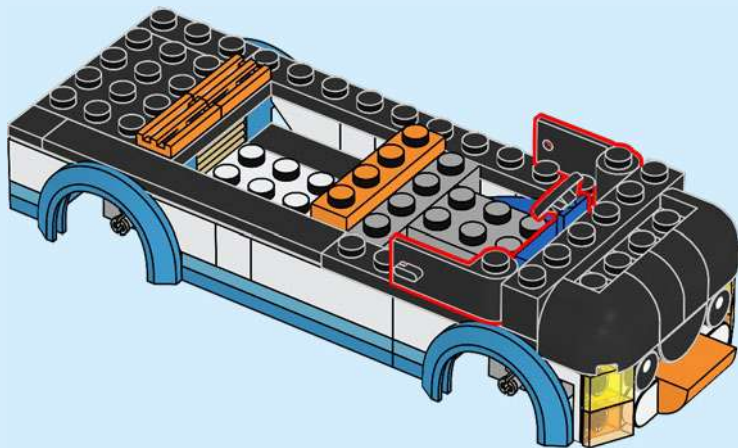

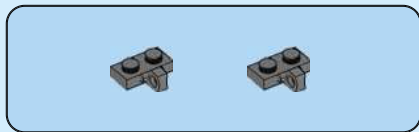

34

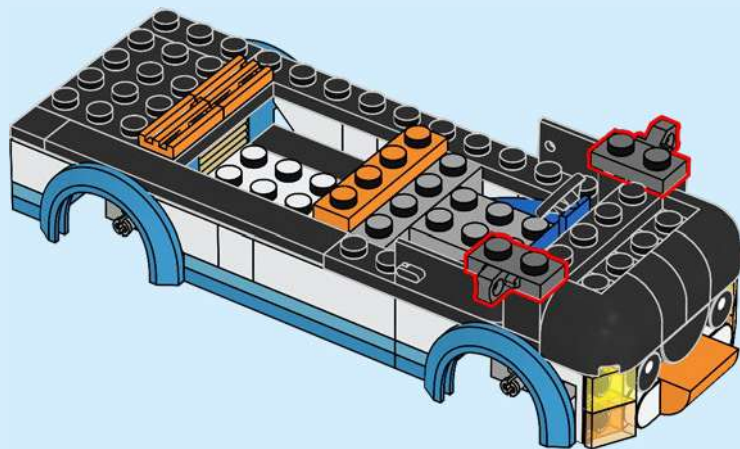



35

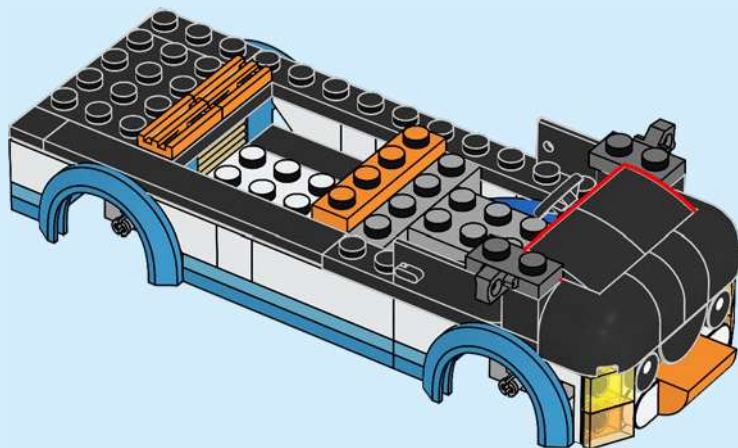



36

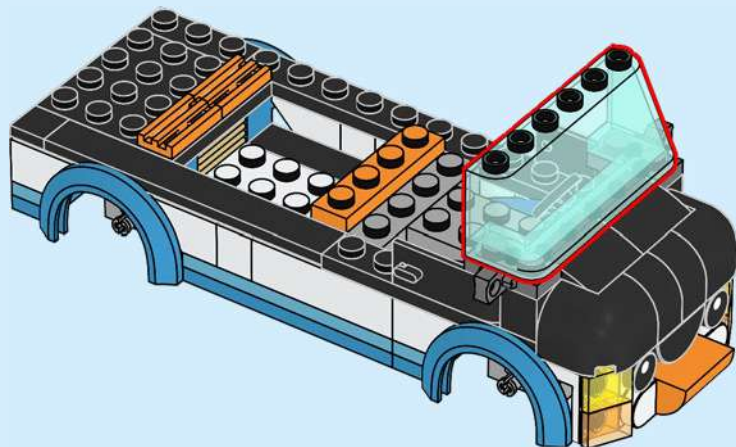



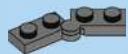

37

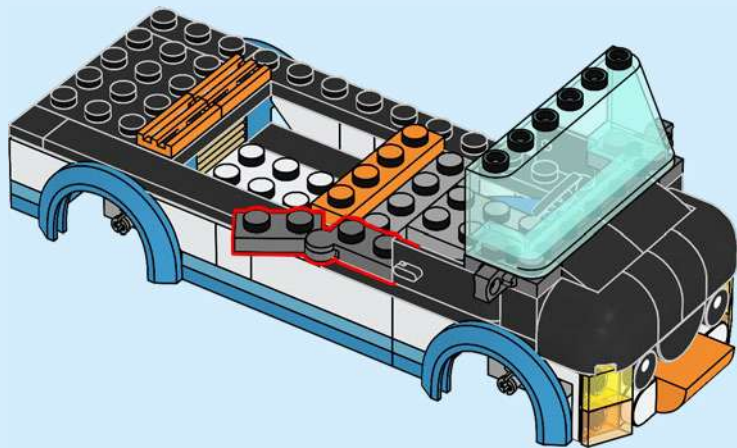

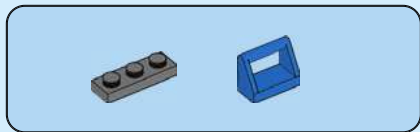

38

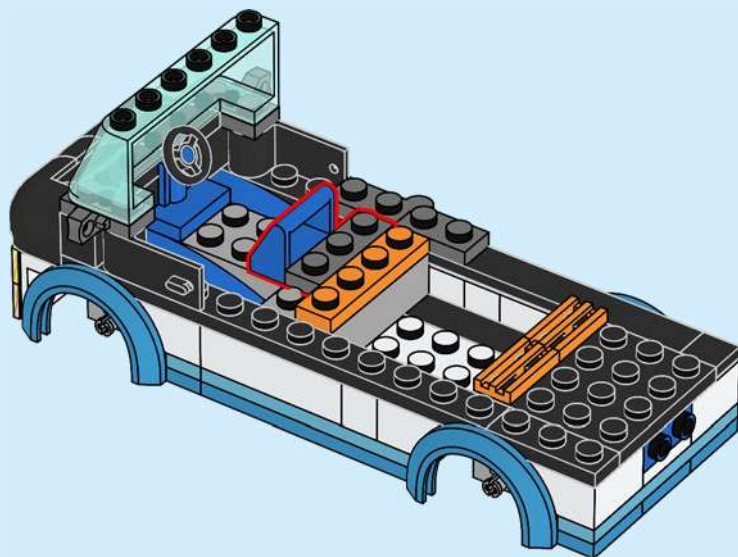
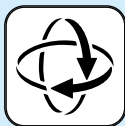



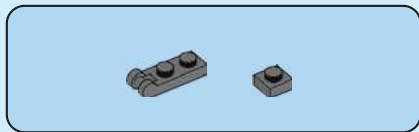

39

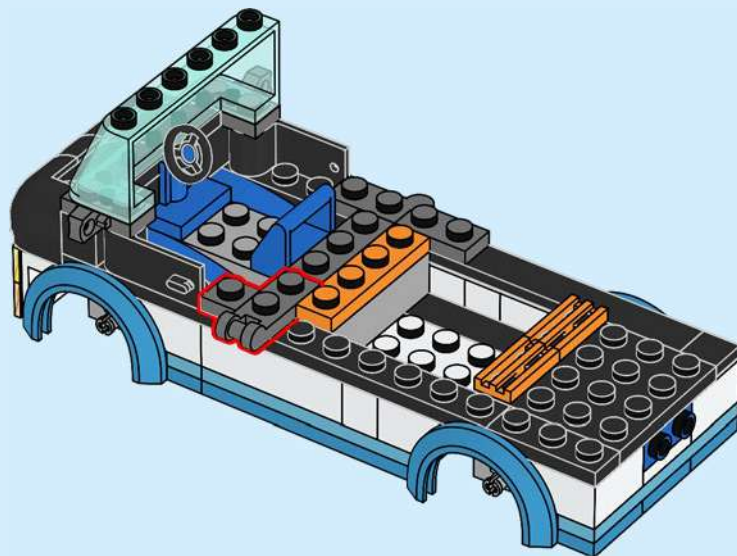

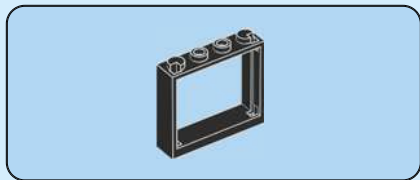

40

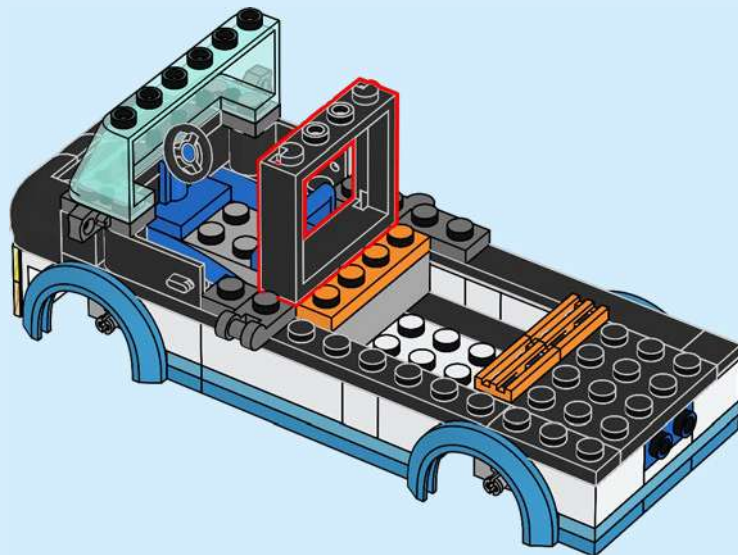

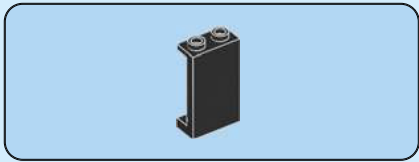

41

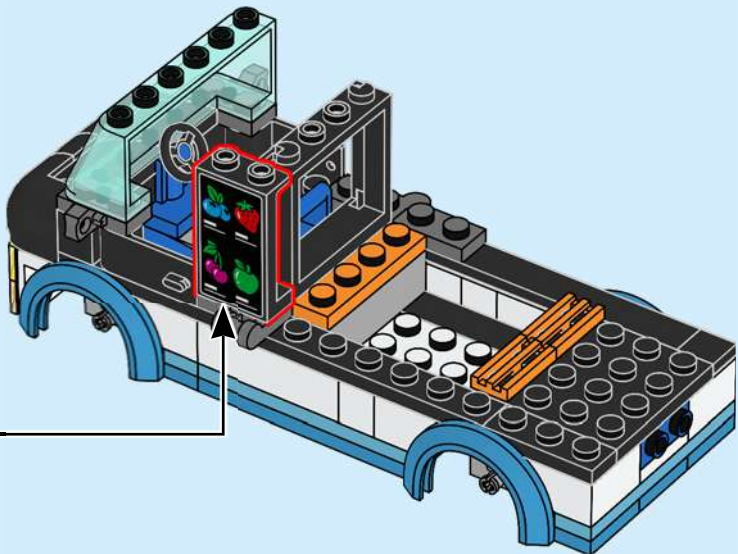
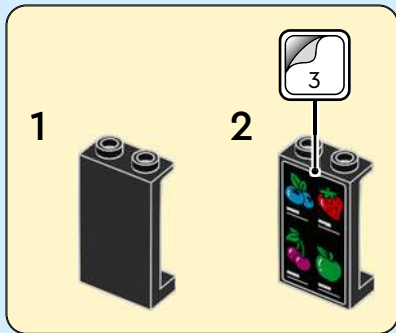

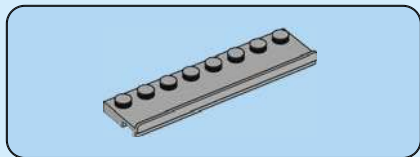

42

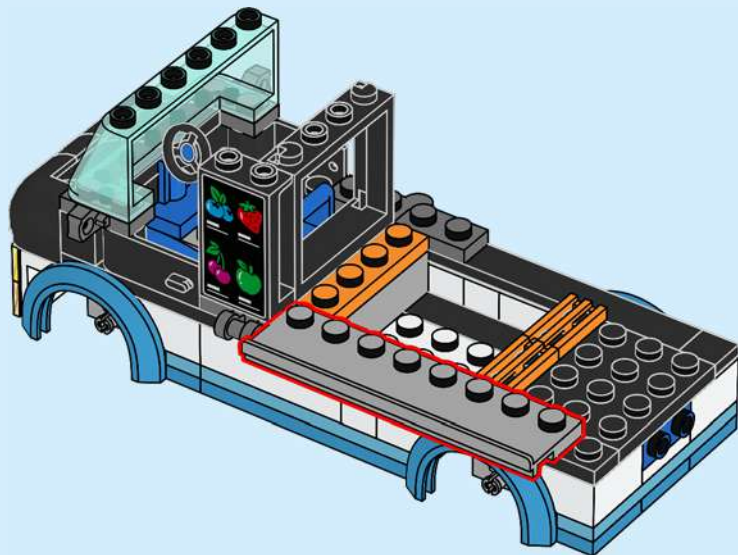

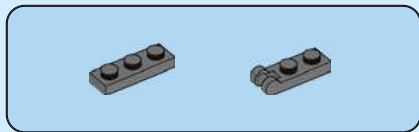

43

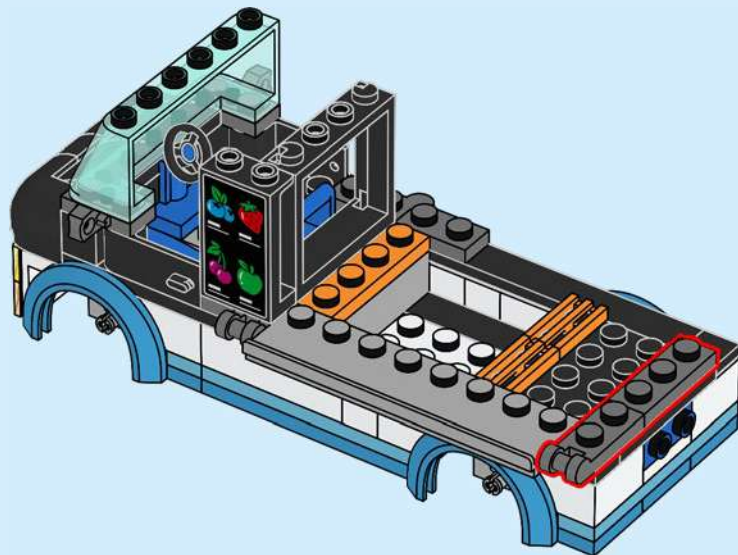

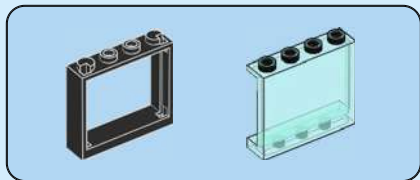

44

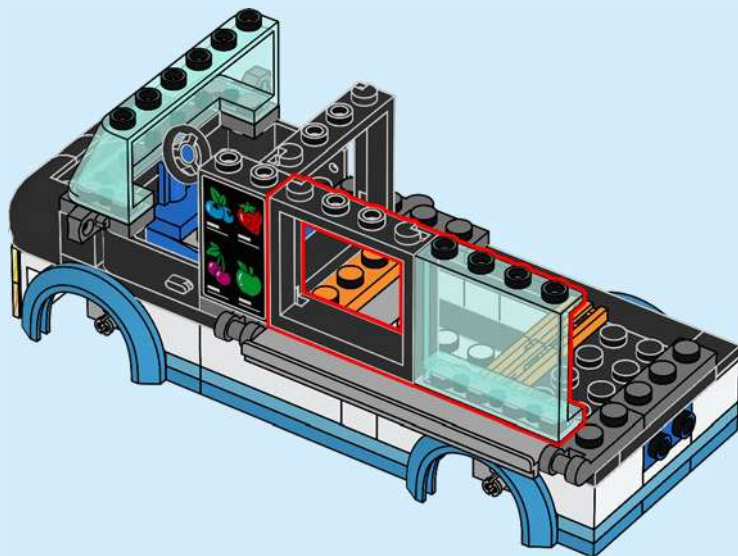

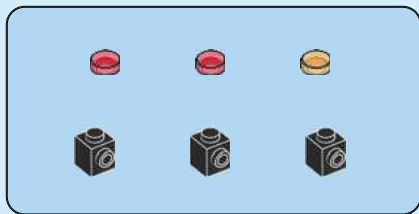

45

1



2

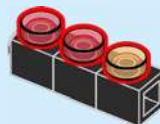

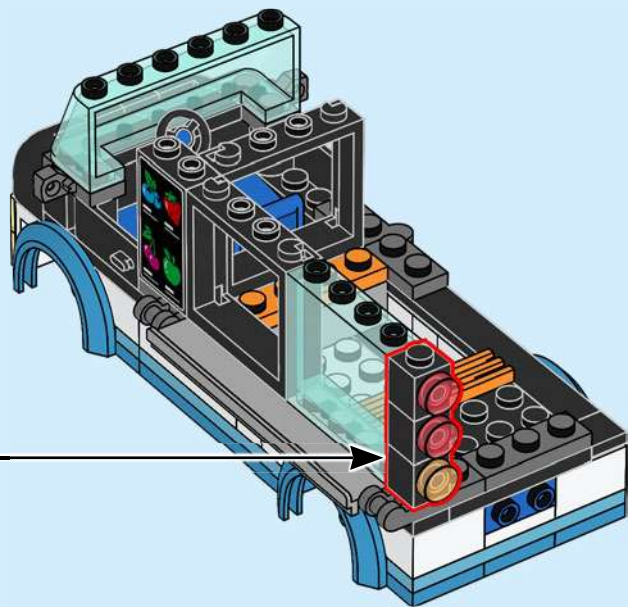



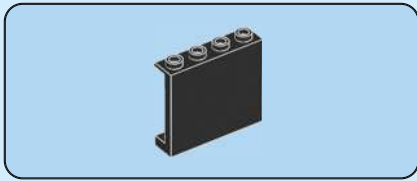

46

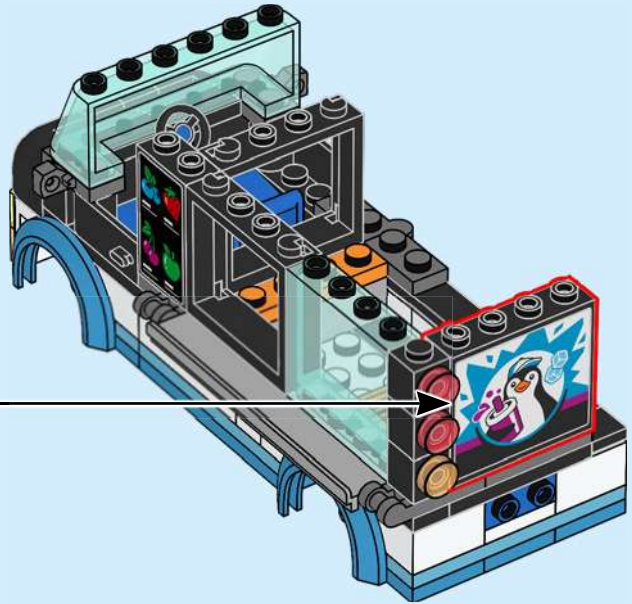
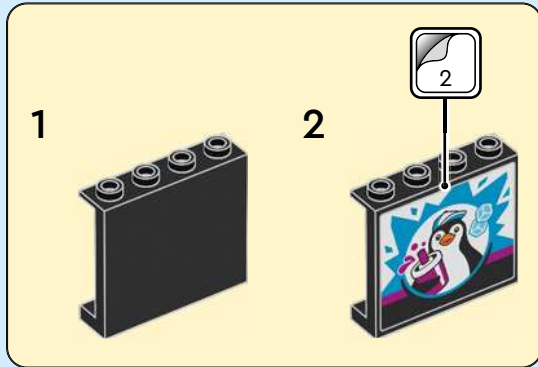

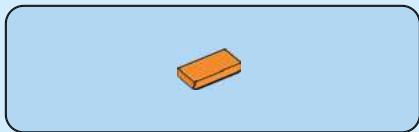

47

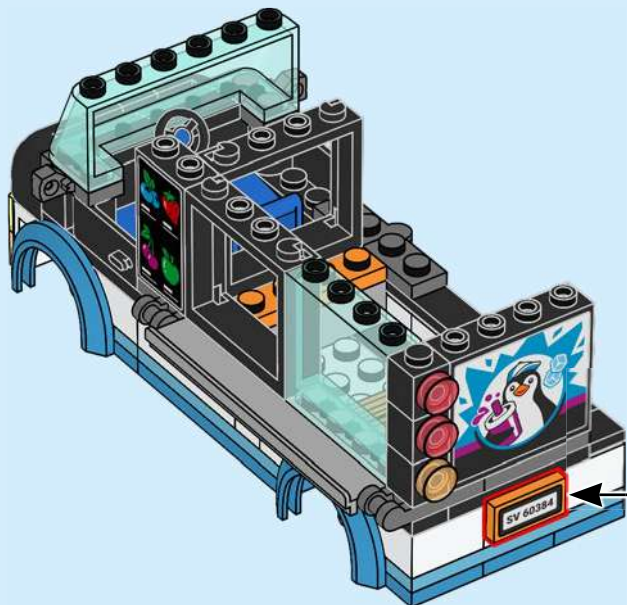

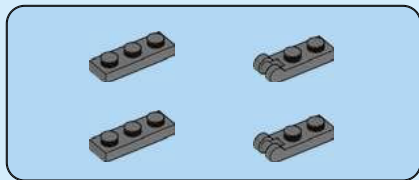

48

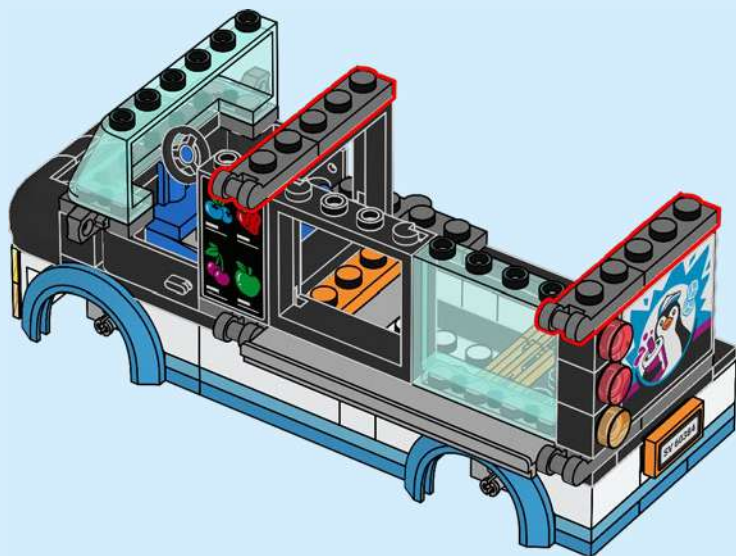



49

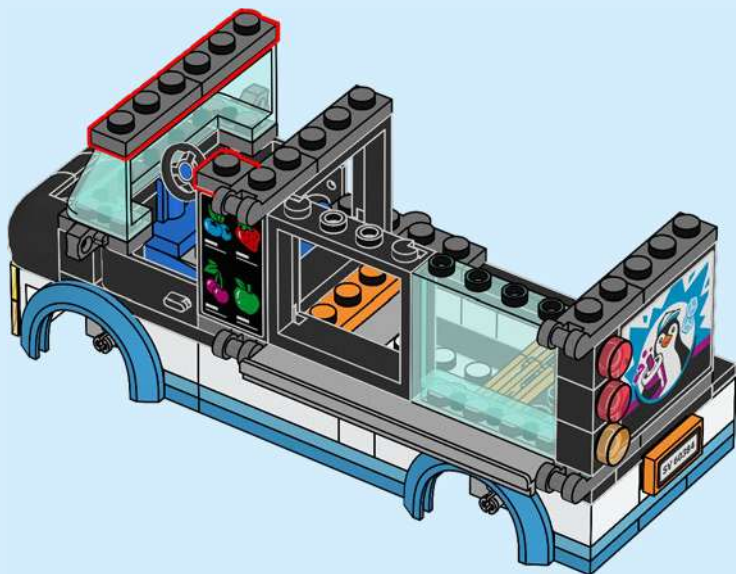

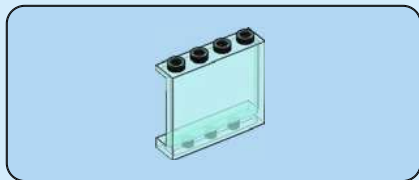

50

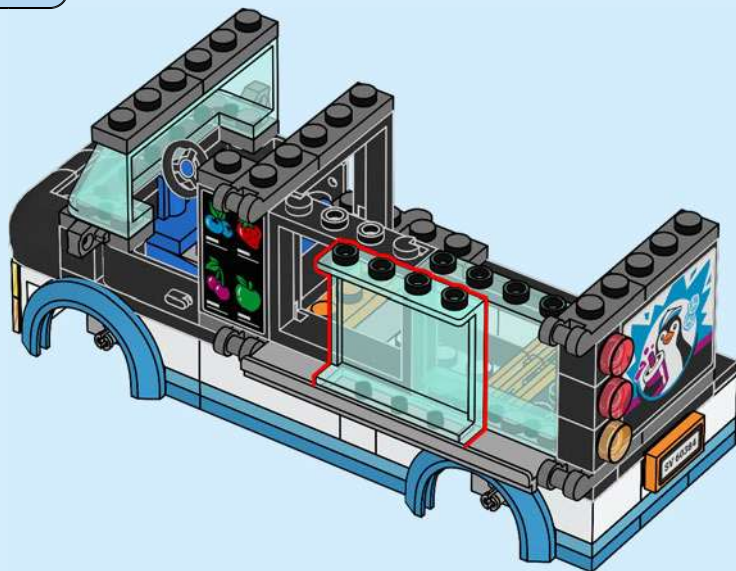

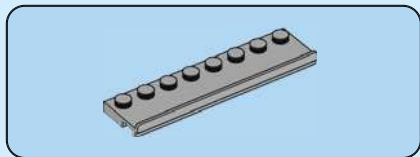

51

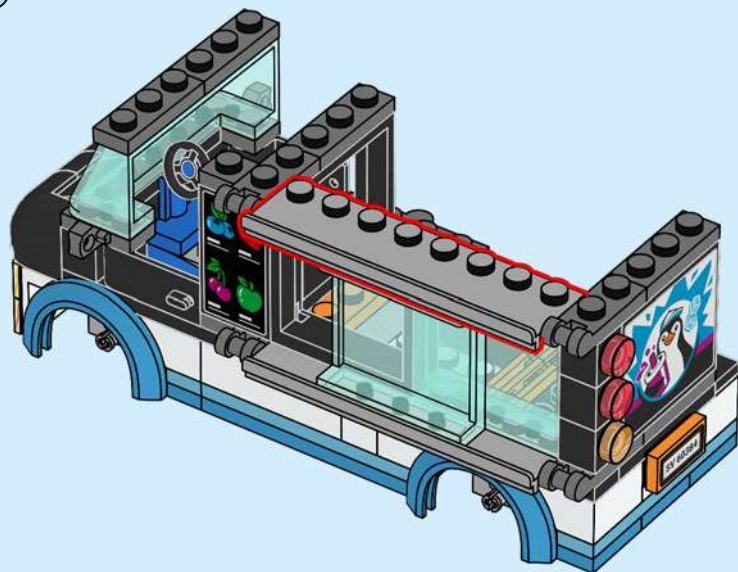

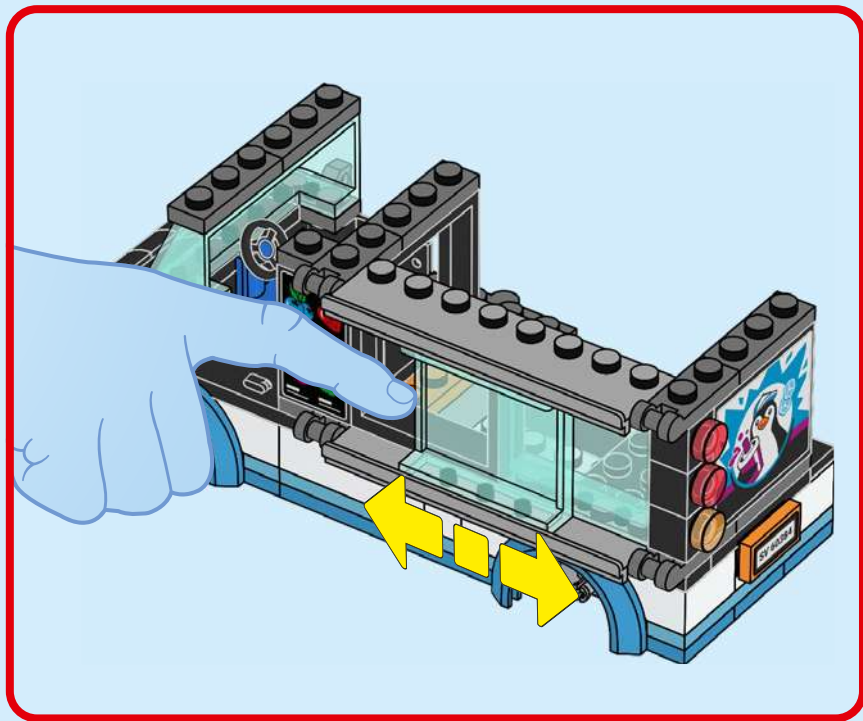



52



53

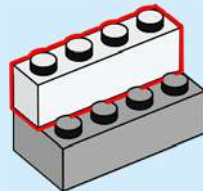



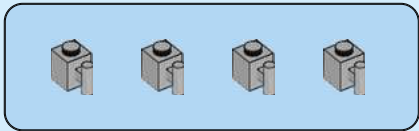

54

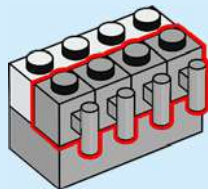

55

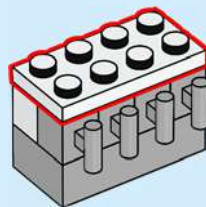

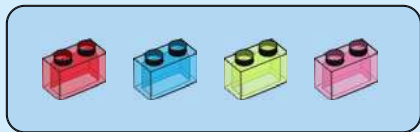

56

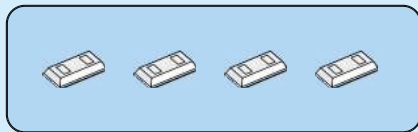
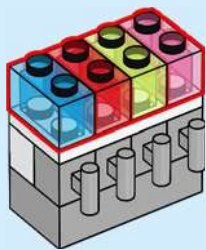

57

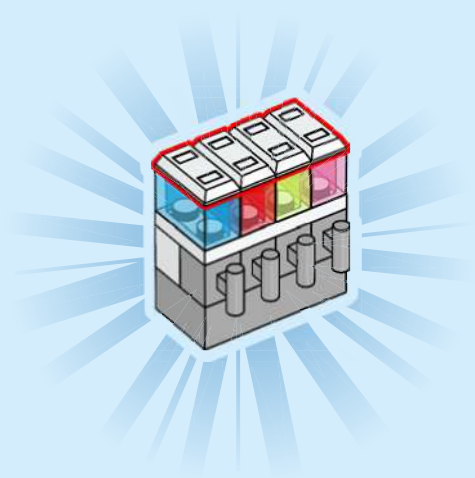

58

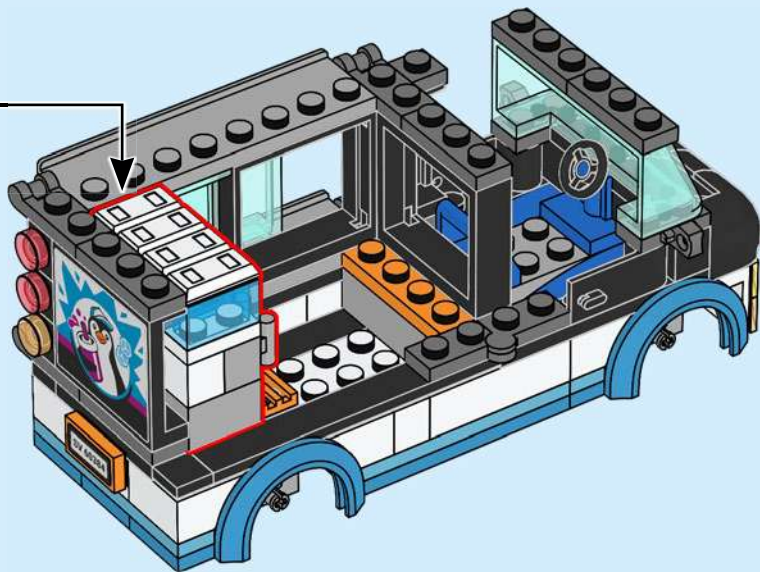
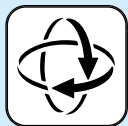

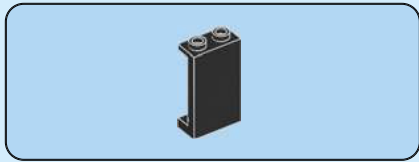

59

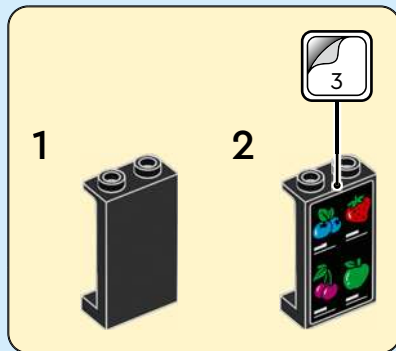
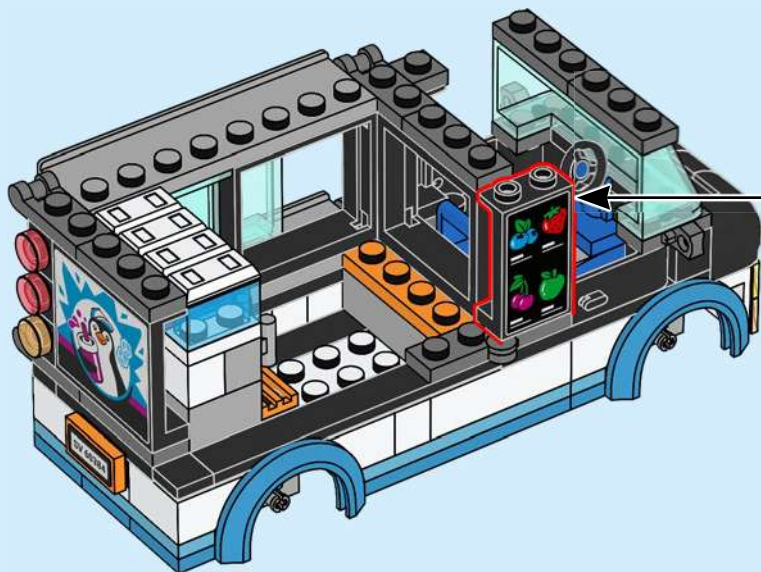



60

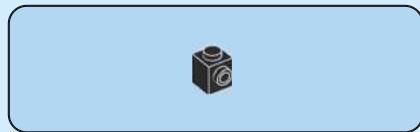
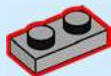

61



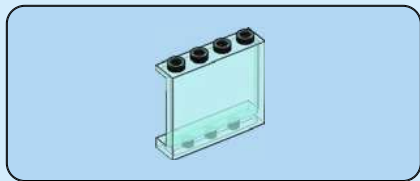

62



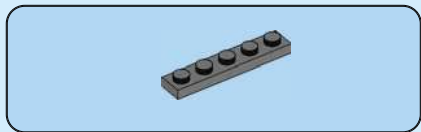

63

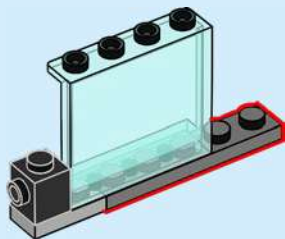

64

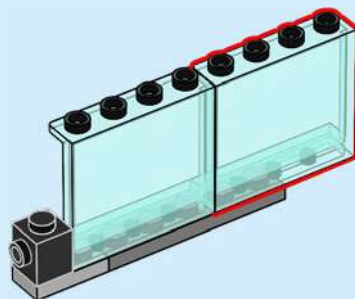



65

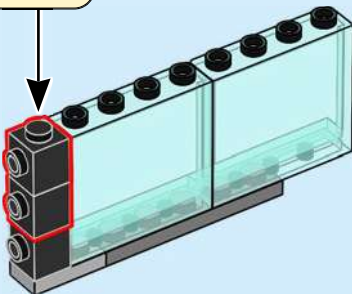
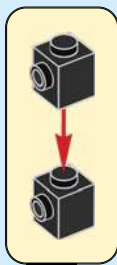



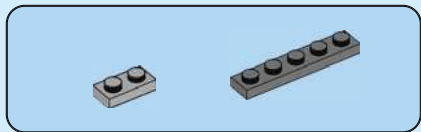

66

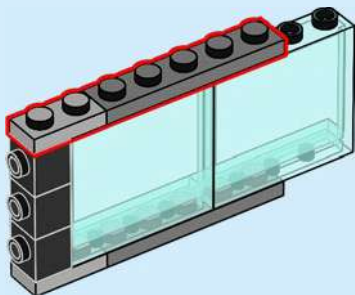

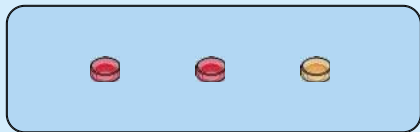

67

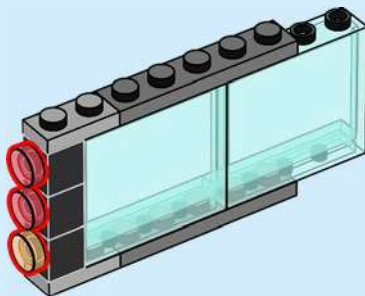

68

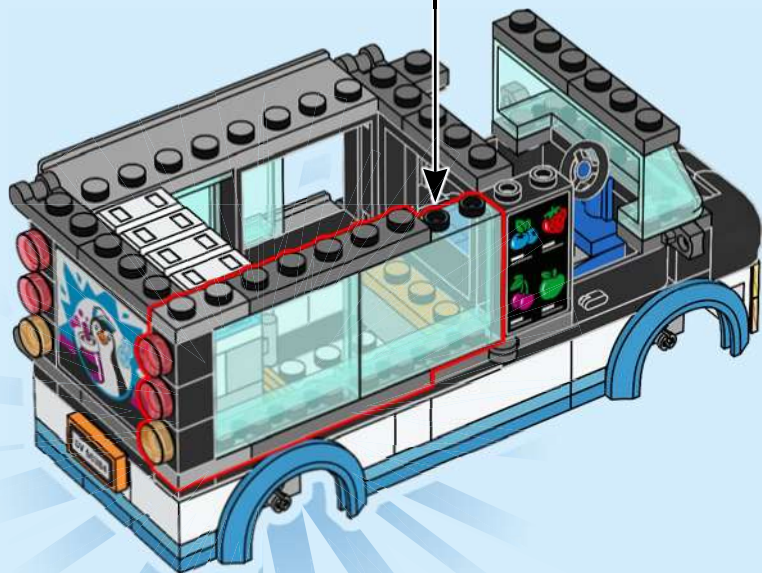

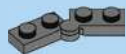

69

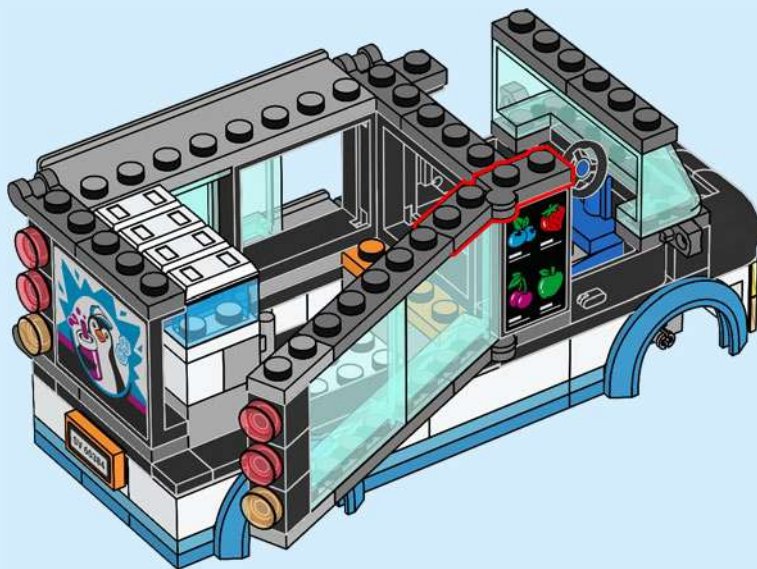

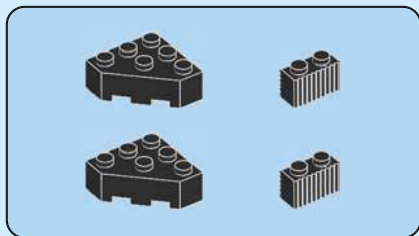

70

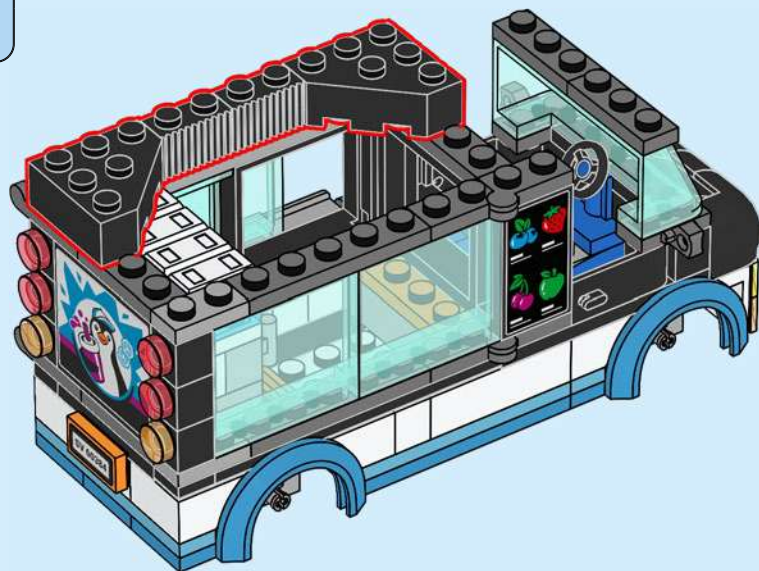

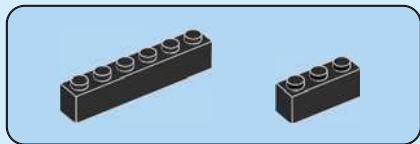

71

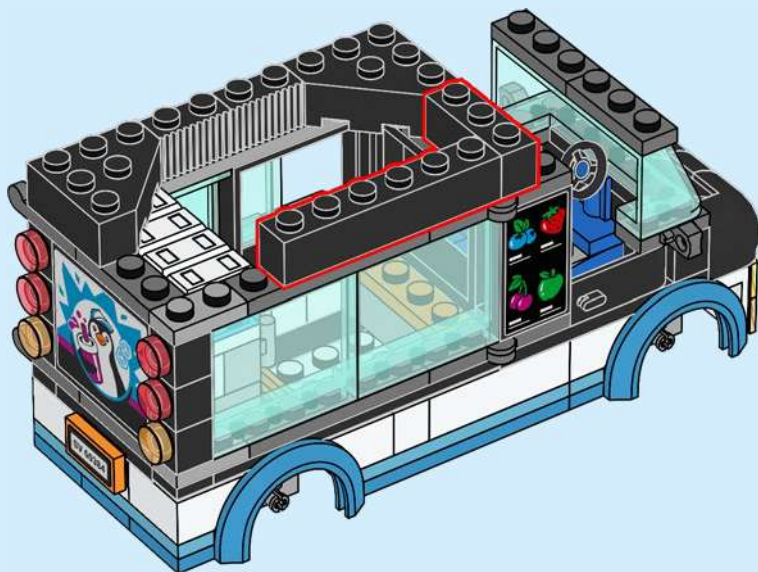



72

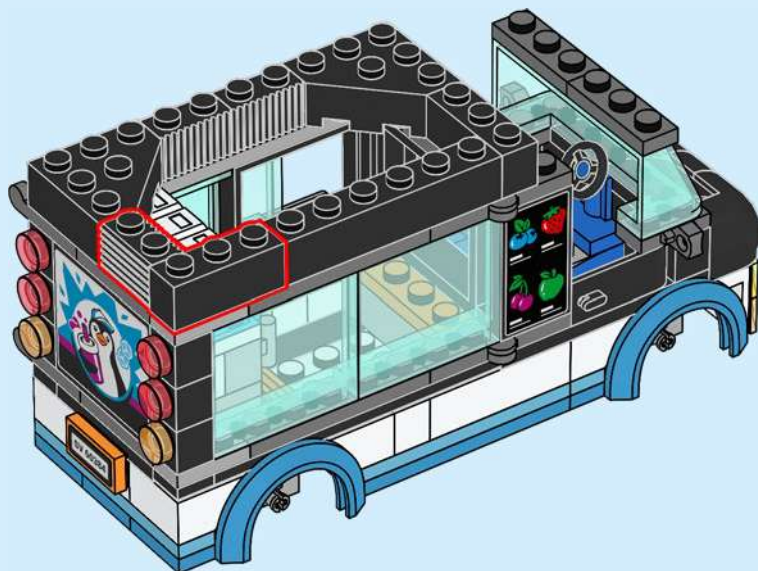



73

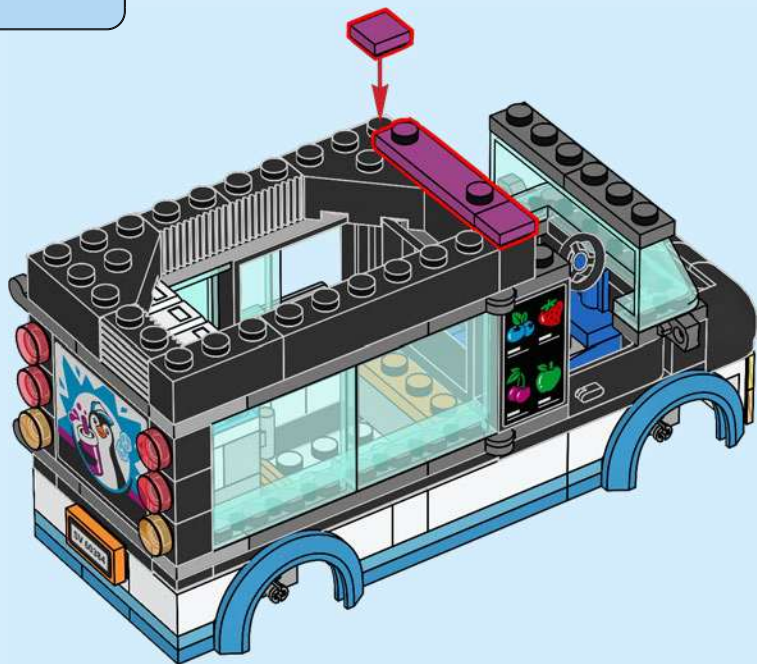



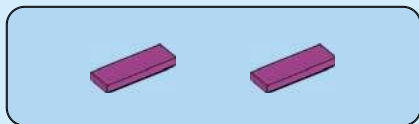

74

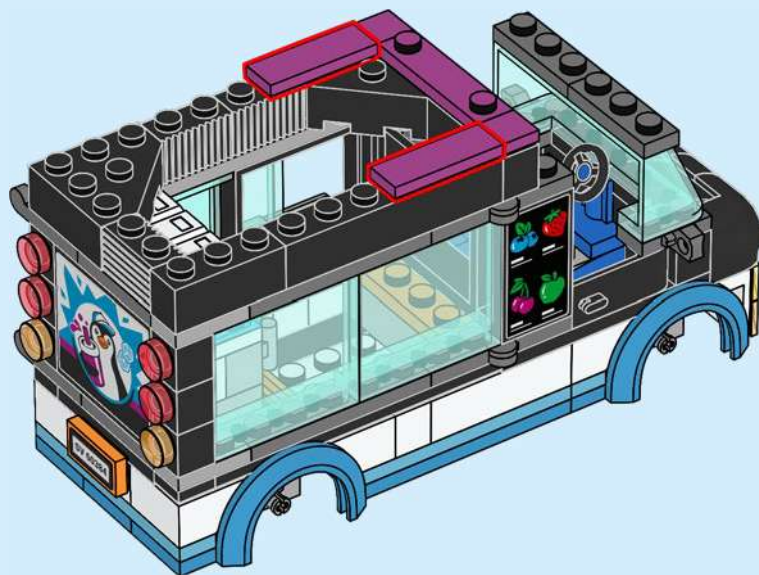

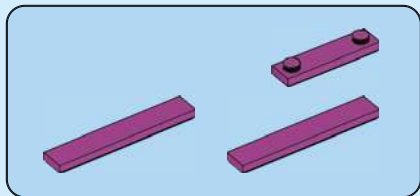

75

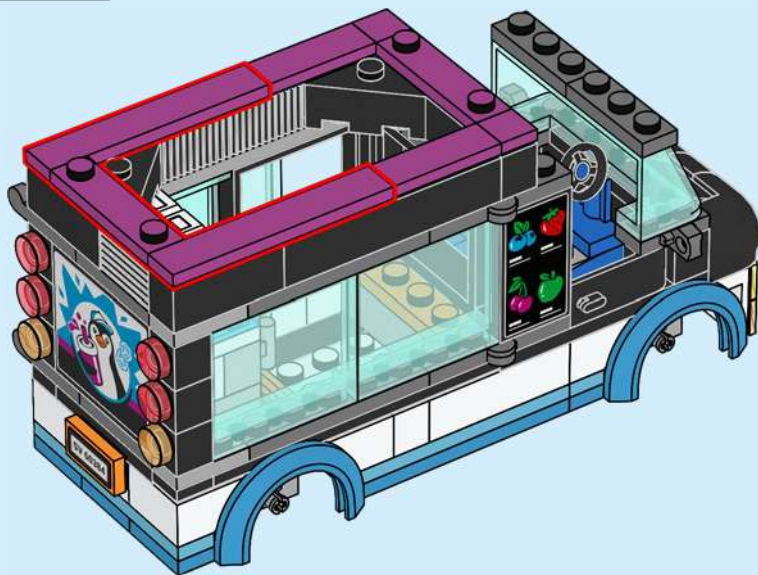

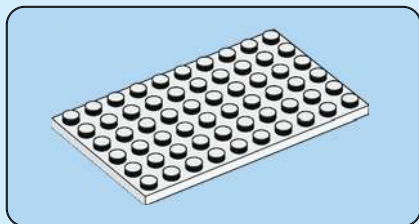

76

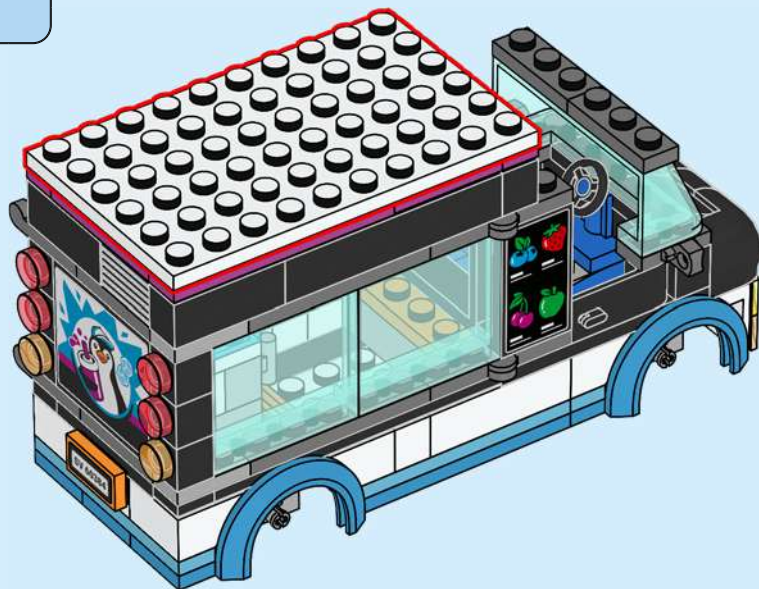

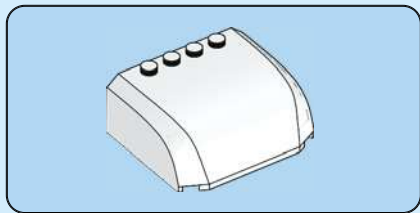

77

1

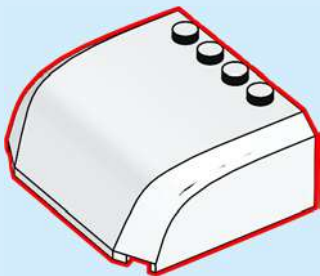

2

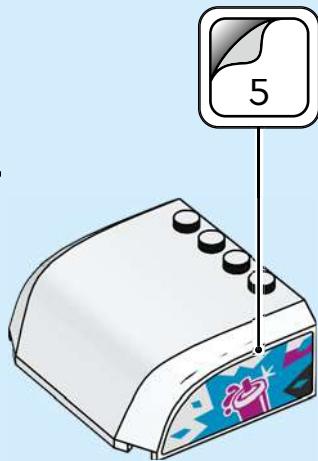

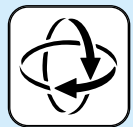

3

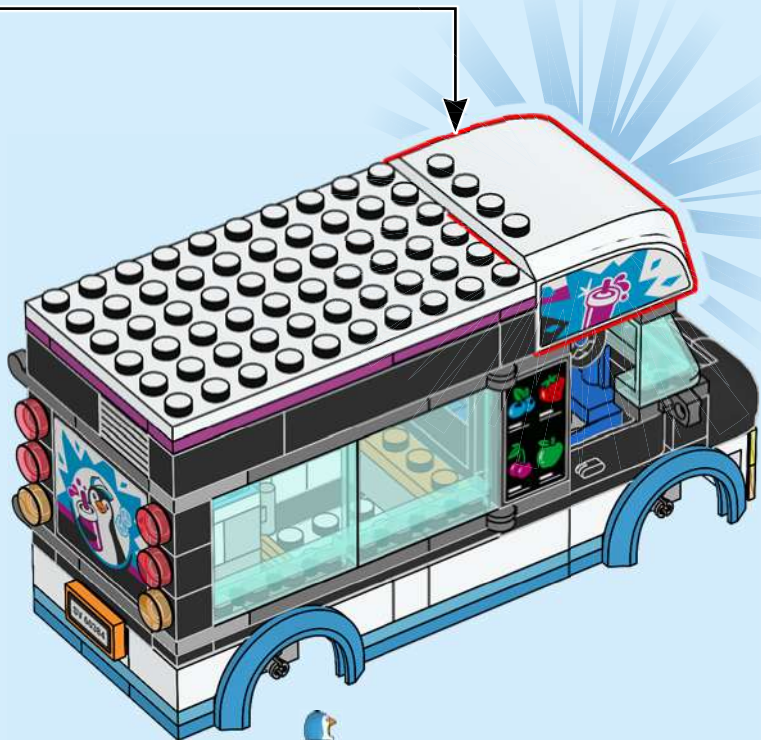
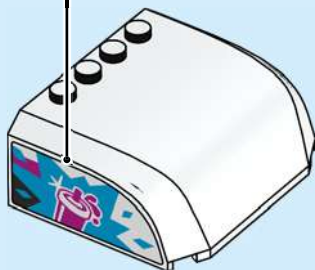

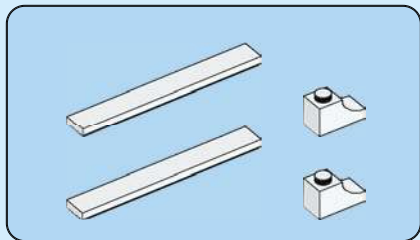

78

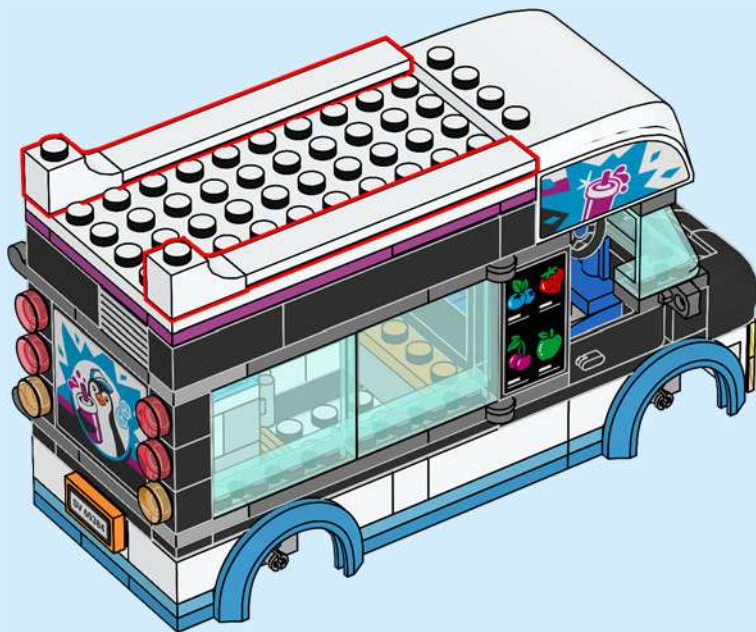

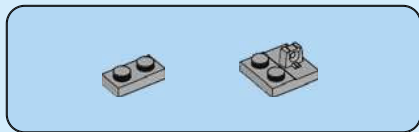

79

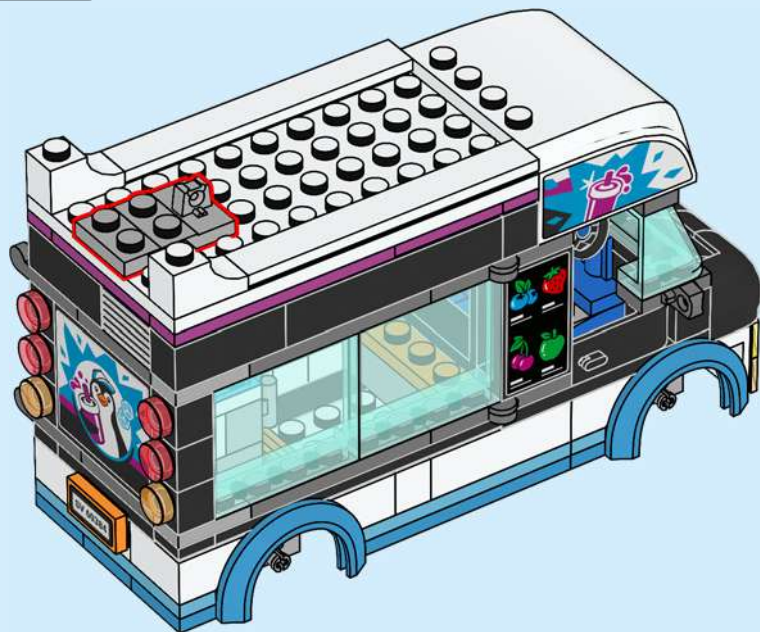



80

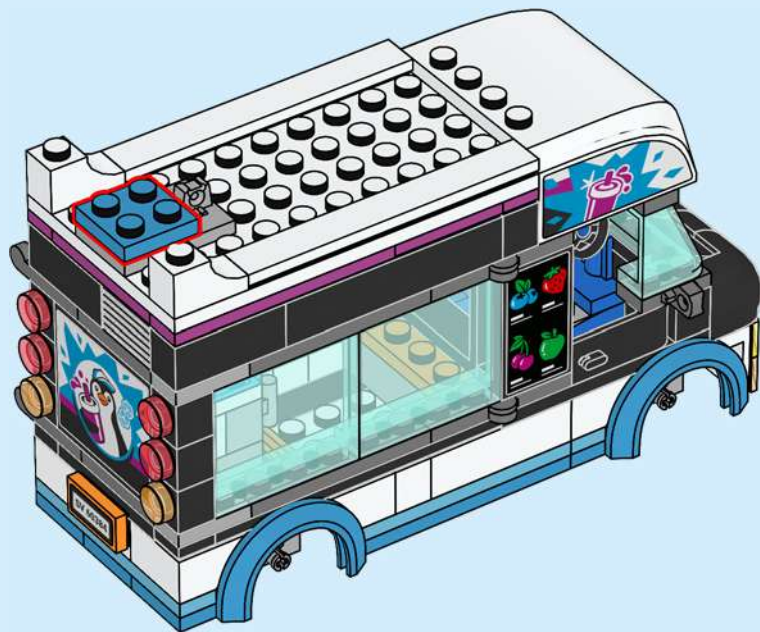



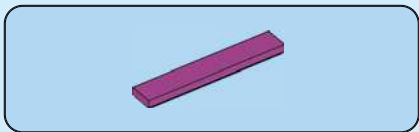

81

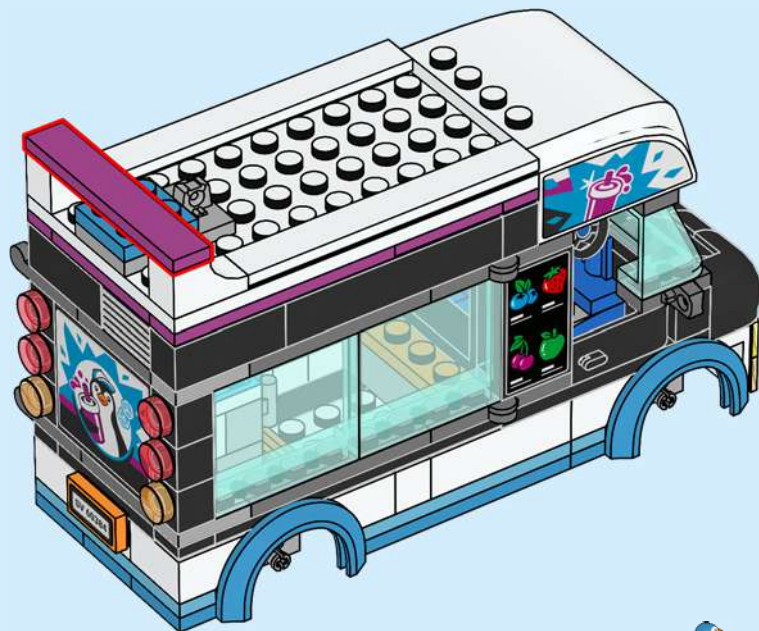



82





83

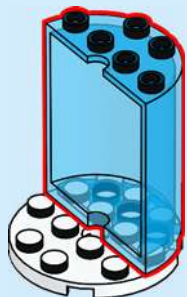

84



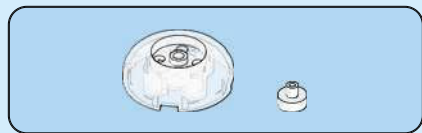

85





86



87



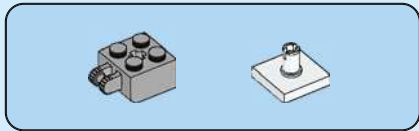

88

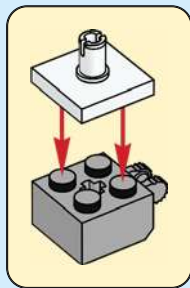

89

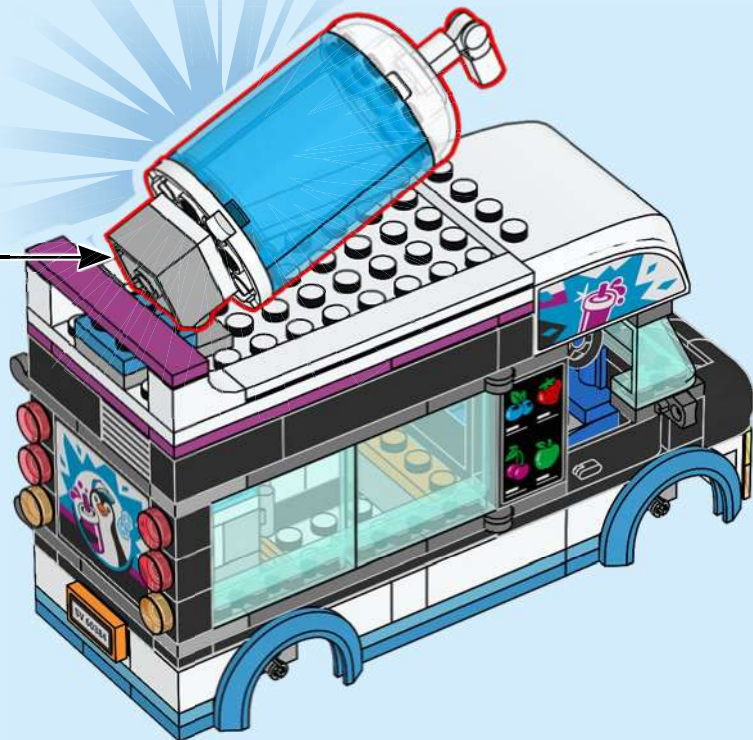

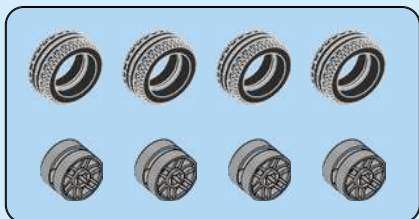

90

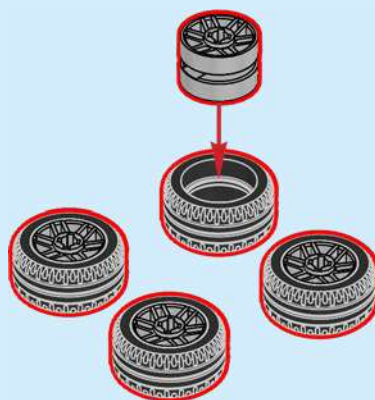



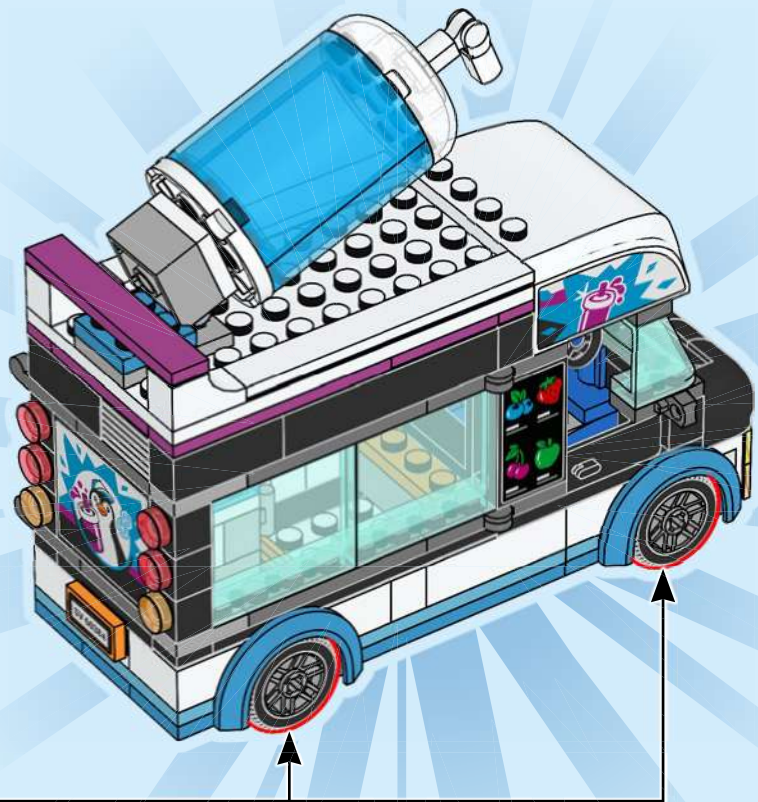

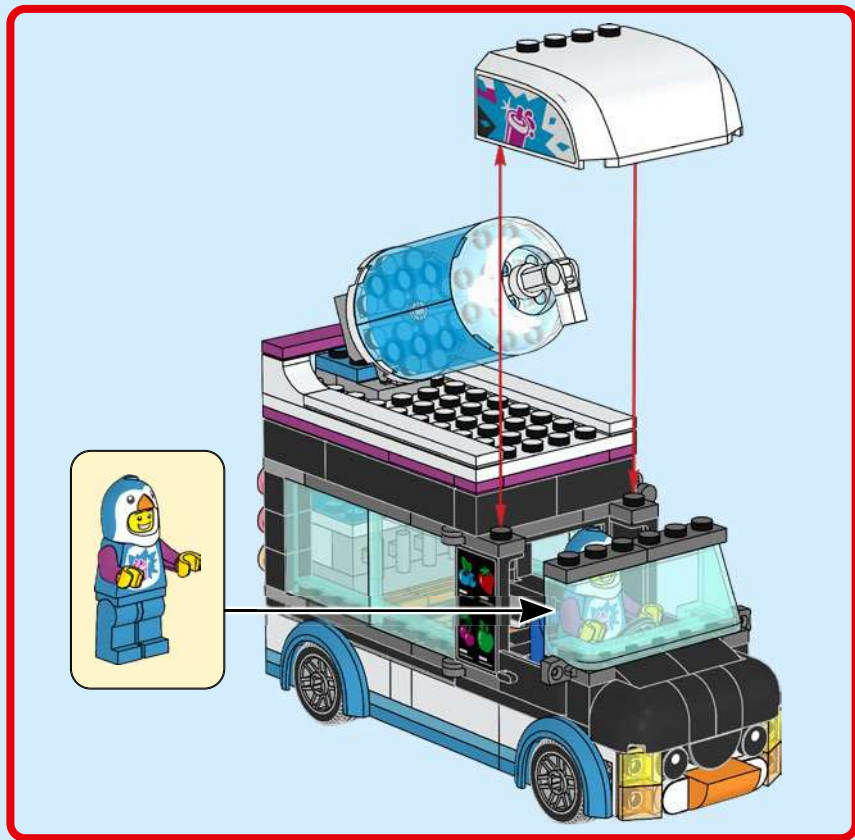





# CITY



60387



60389



60383



60384



60385

**LEGO**

**CITY**





1x  
6341465



1x  
6322489



1x  
6186681



2x  
6250591



2x  
300501



4x  
366501



2x  
6346616



4x  
6210076



3x  
6117940



1x  
6313138



2x  
6366391



1x  
6425508



3x  
301001



1x  
4515347



3x  
302001



2x  
416201



1x  
6210111



1x  
4528341

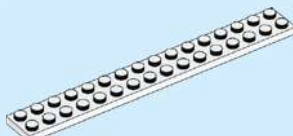

1x  
4119227



2x  
300926

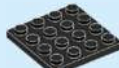

1x  
4243819



3x  
416226



1x  
4514845



2x  
4530589



2x  
4159550



1x  
366626



1x  
6024113



4x  
6029208



2x  
6053077



2x  
6359039



1x  
6024114



2x  
6284072



6x  
4558954



3x  
287726



2x  
4614788



2x  
6184784



1x  
362326



2x  
362226



1x  
6420852



1x  
4558209



1x  
307026



1x  
9566



1x  
243223



1x  
6116797



2x  
6045938



1x  
6330903



1x  
302221



1x  
6312495



1x  
6153335

2x  
6186867



1x  
6360033



1x  
6238673



4x  
6258607



1x  
6244905



4x  
6245267



1x  
6245193



1x  
6238044



1x  
6244906



2x  
6422707



2x  
6245272



1x  
6385785



1x  
4188771



4x  
4125254



2x  
4118782



1x  
6322126



1x  
6244913



1x  
6244911

2x  
6099364



2x  
6211410



2x  
6249090



3x  
6102821



2x  
6274747



2x  
6245265



4x  
6170569



3x  
4211398



4x  
6029209



1x  
6265742



4x  
6371448



1x  
6263494



3x  
4211385



2x  
4222019



2x  
4210719



2x  
6266248



4x  
4521187



6x  
4211133



2x  
6416526



2x  
6413109



2x  
6185675



1x  
6333518



4x  
4653988



1x  
6206809



1x  
6425483



1x  
6005307



1x  
6419171



4x  
6133729



2x  
4640891



1x  
6249123



1x  
6381912



2x  
4625036

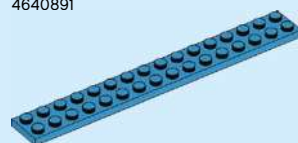

1x  
6249123

 [LEGO.com/service](https://www.lego.com/service)



YOU COULD **WIN**

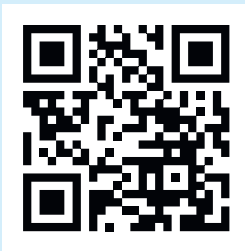

Scan this QR code or go to **LEGO.COM/PRODUCTFEEDBACK** and give us your short feedback about this LEGO® set for a chance to win a cool LEGO prize.

Terms and Conditions apply\*

**DE: Du könntest GEWINNEN.** Es gelten die Teilnahmebedingungen\* **FR: Tu pourrais GAGNER.** Des conditions s'appliquent\* **IT: Potresti VINCERE tu.** Termini e condizioni sono applicabili\* **ES: Puedes GANAR.** Aplican términos y condiciones\* **PT: Poderá GANHAR.** Aplicam-se termos e condições\* **JA: プレゼント付き! 利用規約が適用されます\*** **ZH: 轻松获奖. 条款和条件适用\*** **KO: 상품의 주인이 되어보세요. 소정의 약관이 적용됩니다\*** **RU: Вы можете ВЫИГРАТЬ.** Действуют положения и условия\* **PL: Szansa na WYGRANĄ.** Obowiązują warunki korzystania\* **CS: Máte šanci VYHRÁT.** Platí všeobecné smluvní podmínky\* **SK: Máte šancu VYHRAŤ.** Platia všeobecné zmluvné podmienky\* **HU: TE IS NYERHETSZ.** Felhasználási feltételek érvényesek\* **RO: Ai putea CÂȘTIGA.** Se aplică termenii și condiții\* **BG: Можете да СПЕЧЕЛИТЕ.** Има определени правила и условия\* **LV: Tu vari LAIMĒT.** Ir spēkā noteikumi un nosacījumi.\* **ET: Sul on võimalus VÕITA.** Kehtivad tingimused\* **LT: Jūs galite LAIMĖTI.** Taikomos sąlygos\*

\*LEGO.com/productfeedback-terms