

CREALITY

Create reality, achieve dreams

K1 Max

K1 Max

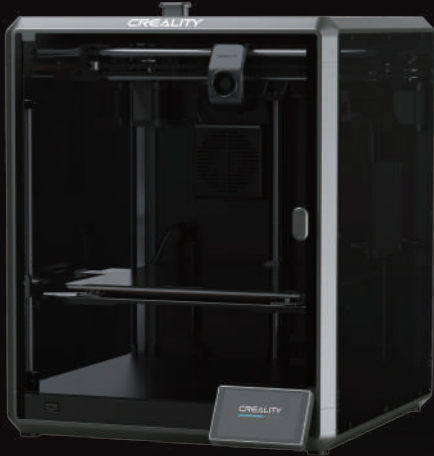

3D Printer User Manual

V1.4

Thank you for choosing our products. For the best experience, please read this User Manual carefully and strictly follow the instructions to operate the printer. Our teams will always be ready to provide you with the best services. Please contact us via the phone number or e-mail address provided at the end of this User Manual when you encounter any problem with the printer. For a better experience in using our products, you can also learn how to use the printer in the following ways: Accompanied instructions: you can find the relevant instructions and videos in the USB flash disk.

You can also visit our official website (<https://www.creality.com>) to find information regarding software, hardware, contact information, device instructions, device warranty information, and more.

NOTES

- 1 Do not use the printer in any way other than described herein in order to avoid personal injury or property damage;
- 2 Do not place the printer near any heat source or flammable or explosive objects. We suggest placing it in a well-ventilated, cool and dustless environment;
- 3 Do not expose the printer to a violent vibration or any other unstable environment, as this may cause poor print quality;
- 4 Please use recommended filaments to avoid clogging of the extrusion head and causing damage to the machine;
- 5 Do not use the power cable of other products during installation. Always use a grounded three-prong power outlet, which accompanies the printer;
- 6 Do not touch the nozzle and the heated bed during operation to avoid burns or personal injury;
- 7 Do not wear gloves or wraps while operating the machine to prevent entrapment of movable parts that could cause crushing and cutting injuries to bodily parts;
- 8 Use the provided tools to clean the filament from the extruder in time taking advantage of the residual temperature after printing. Do not touch the extruder directly when cleaning, otherwise it may cause burns;
- 9 Clean the printer frequently. Clean the printer body with a dry cloth regularly after powering off the printer, wipe away dust, bonded print filament and foreign objects on the guide rails;
- 10 Children under 10 years old should not use the printer without supervision, otherwise it may cause personal injury;
- 11 Users should comply with the laws and regulations of the corresponding countries and regions where the equipment is located (used), abide by professional ethics, pay attention to safety obligations, and strictly prohibit the use of our products or equipment for any illegal purposes; Creality will not be responsible for any violators' legal liability under any circumstance;
- 12 Tip: Do not plug in or unplug wires on a charged basis.

1. About the Device	01-03
1.1 About the Printer	01-01
1.2 Device Specifications	02-02
1.3 Packing List	03-03
2. Unboxing	04-07
2.1 Unboxing Steps	04-04
2.2 Install the Product	05-06
2.3 Power-on guide	07-07
3. About the User Interface	08-10
3.1 Main、Tune	08-08
3.2 Files	09-09
3.3 Settings、Support	10-10
4 First Printing	11-15
4.1 Local Printing	11-11
4.2 LAN Printing	12-13
4.3 CrealityCloud printing	14-15
5. Functional Specification	16-22
5.1 Retract	16-17
5.2 Change filament	18-19
5.3 Calibration	20-20
5.4 AI function	21-21
5.5 Self-check	21-21
5.6 Network Settings	22-22
6. Tips and Routine Maintenance	23-26
6.1 Precautions for printing	23-24
6.2 Maintenance Items	25-25
6.3 Installation of Damping Pads	26-26

1. About the Device

1.1 About the Printer

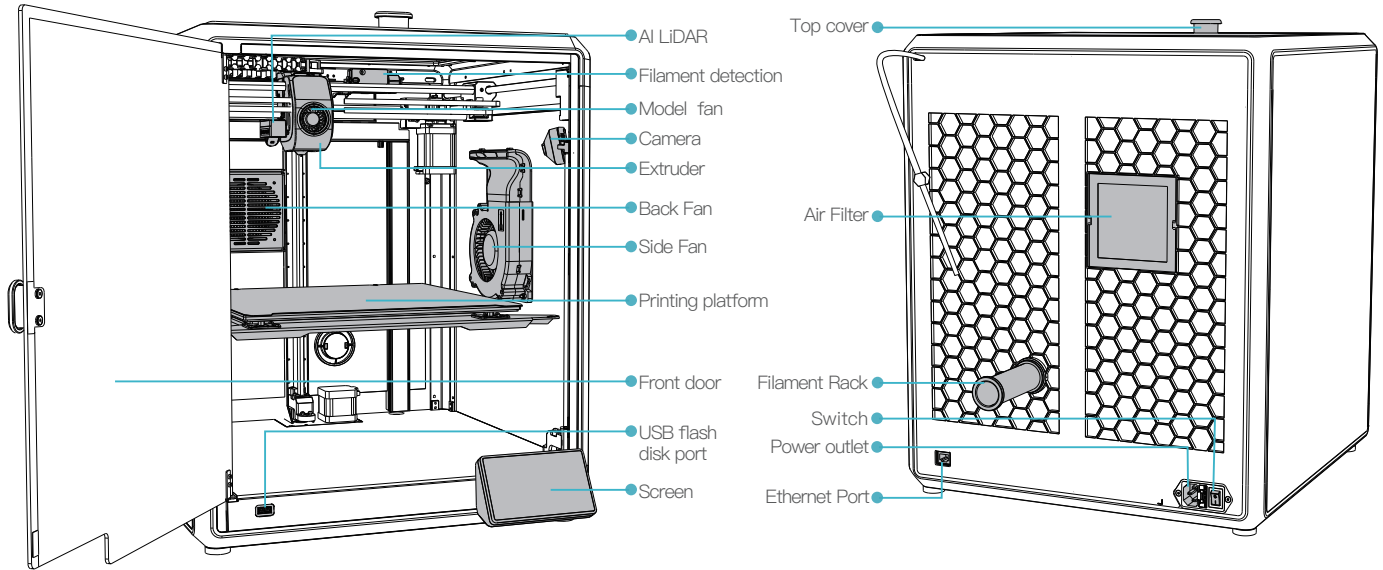

1. About the Device



1.2 Device Specifications

Basic Parameters	
Product Model	K1 Max
Dimensions	435*462*526mm
Max. Build Dimensions	300*300*300mm
Print Technology	FDM
Rated Voltage	100–240V~, 50/60Hz
Rated Power	1000W
Ambient temperature	10°C–30°C / 50°F–86°F
Extruder	Sprite Direct Drive
Supported Filament	PLA/ABS/Carbon/PETG/PET/TPU95A
Max. Nozzle Temperature	300°C
Screen	4.3 inch touch screen
Printing Method	USB Flash Disk/LAN Printing/Crealty Cloud Printing
Connection	USB flash disk/WIFI/Ethernet
Power Loss Recovery	Yes
Filament Detection	Yes
Auto leveling	Yes
Camera	Yes
AI LiDAR	Yes

1. About the Device

1.3 Packing List

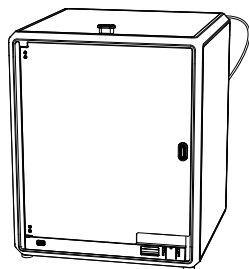

1 Printer

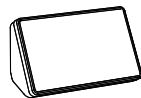

2 Screen

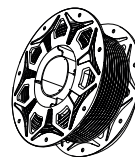

3 Filament

Tool Box List

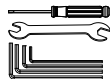

4 Wrench and Screwdriver x1



5 Blade x1

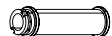

6 Filament Rack x1

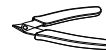

7 Cutting plier x1



8 1.2mm nozzle cleaner x1



9 USB flash disk x1



10 Power Cable x1



11 M6 socket spanner x1



12 Damping Pads x4



13 Belt tensioning screw M3x12 x2



14 Quick Guide x1



15 After-sales Services Card x1

* Tips: the above accessories are for reference only. Please refer to the physical accessories!

2. Unboxing

2.1 Unpacking Steps

Take the packing cotton and tools in the order as shown in figure.

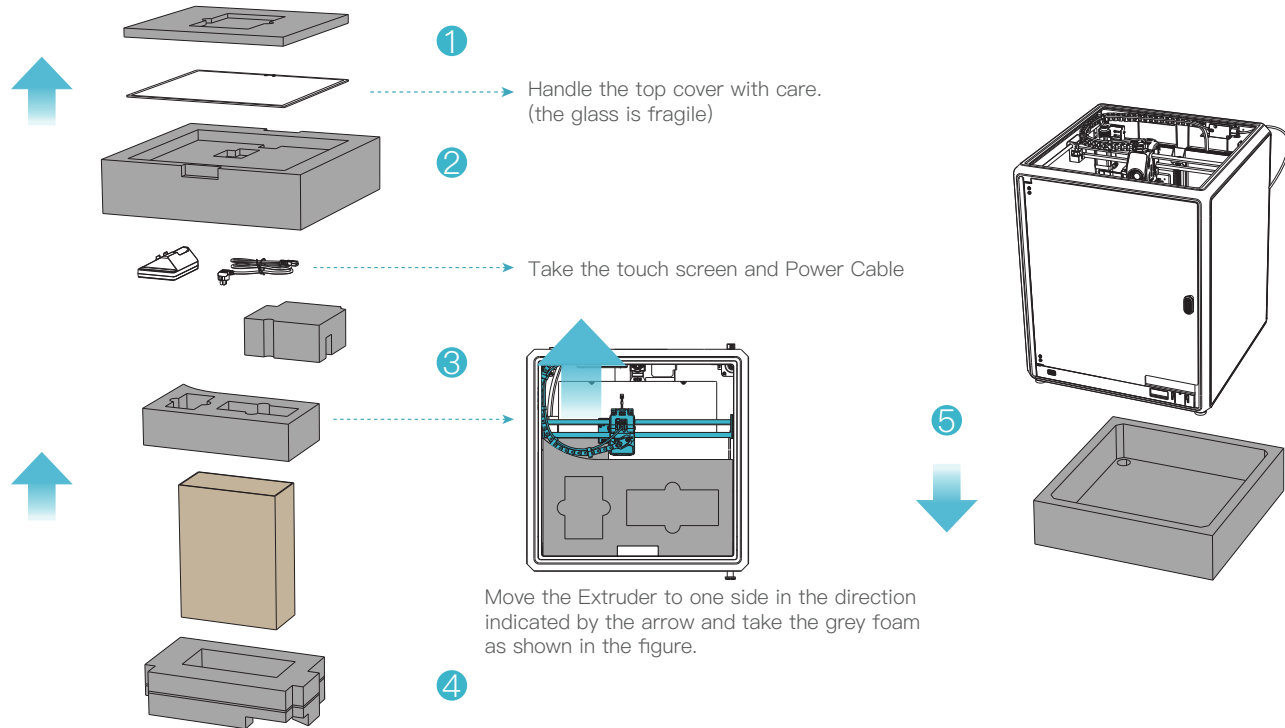

2. Unboxing

2.2 Install the Product

① Install the door handle on the front door as shown in the diagram.

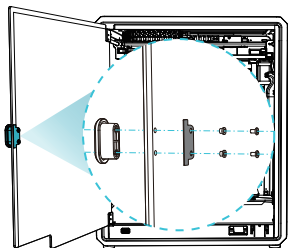

② Connect the touch screen to the flat cable extended from the base according to Figure A. Then snap the touch screen into the slot in the baseplate, as shown in Figure B. (The direction is as shown in the figure; otherwise, the screen interface may be damaged.)

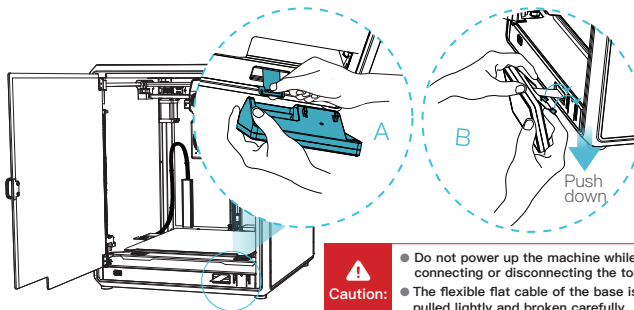

③ A: Connection and power on.
B: Install the material barrel.

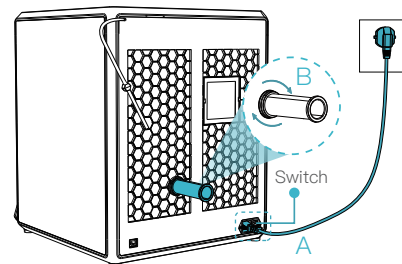

④ Load filaments. (Insert the filaments into the deepest part of Teflon tube until it cannot be moved.)

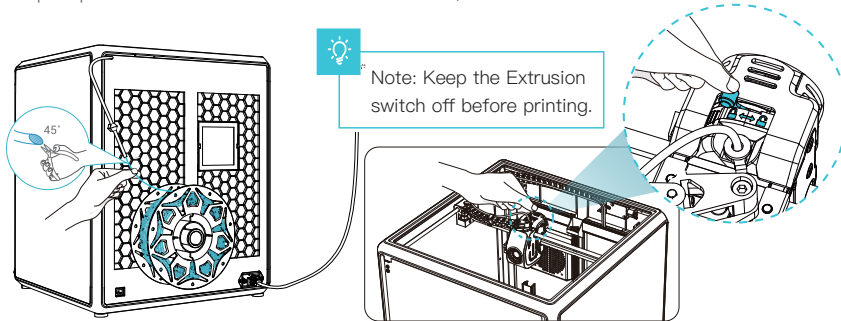

⑤ Install the top cover.
(Put the top cover gently on the top of the machine.)

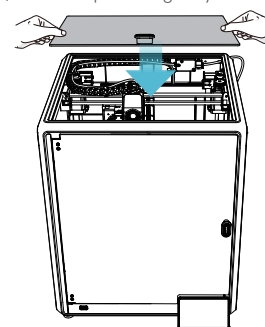

Caution:

1. When printing low-temperature filaments such as PLA and flexible filaments, remove the clear top cover if the room temperature exceeds 30°C.
2. When printing high melting-point filaments such as non-PLA and non-flexible filaments, be sure to keep the forming chamber temperature with the clear top cover closed to avoid cracking of the mould.

2. Unboxing

2.2 Install the Product

⑥ Select a language and click “Next”, Remove three screws a, b and c according to the location indicated by the yellow arrow. click “OK” on the screen.

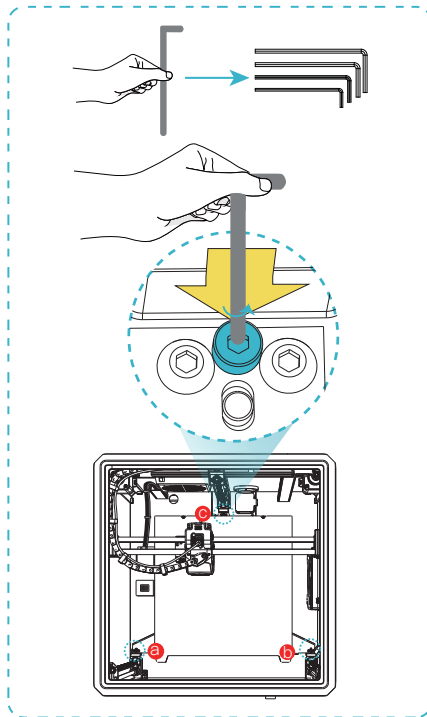
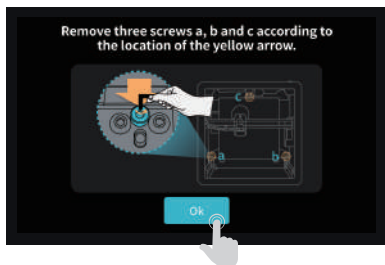
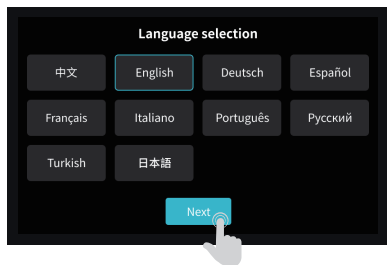

⑦ Keep the blue cube in the figure clean of debris and then click “OK”.

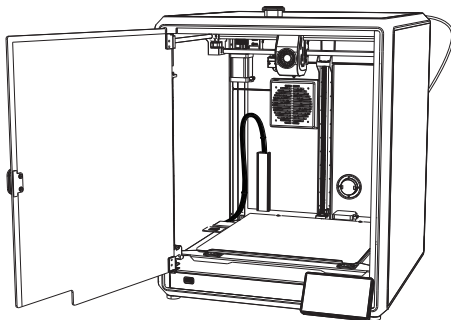

2. Unboxing

2.3 Power-on guide

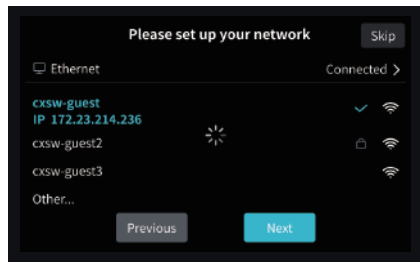

① Network Settings

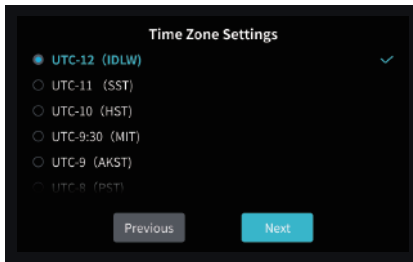

② Time Zone Settings

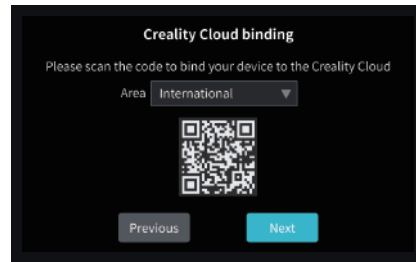

③ Creality Cloud binding

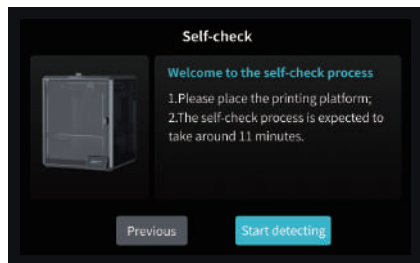

④ Self-check

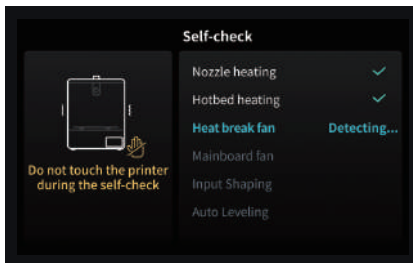

⑤ Self-checking

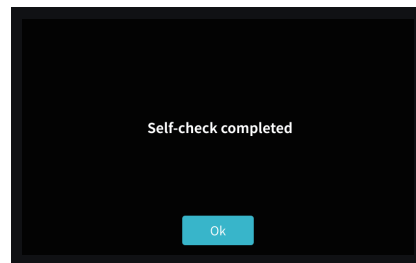

⑥ Self-check completed



Note: The current interface is for reference only. Due to the continuous upgrading of functions, it shall be subject to the latest firmware UI published on the official website.

3. About the User Interface

3.1 Main、Tune

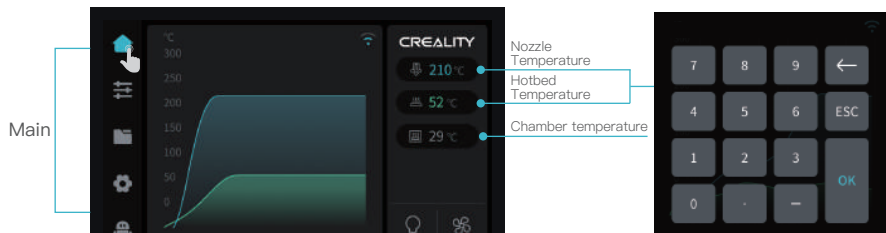

Parameters can be manually set

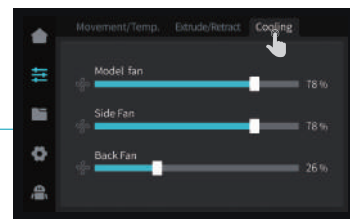
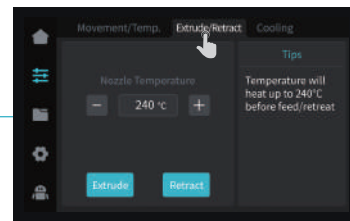
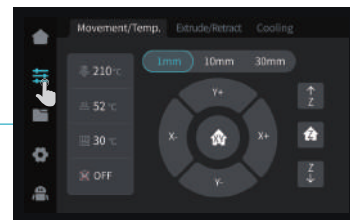
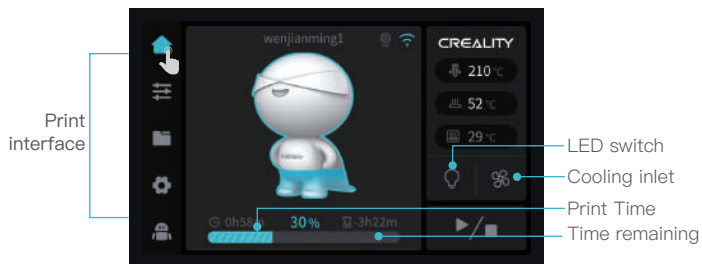

Note: The current interface is for reference only. Due to the continuous upgrading of functions, it shall be subject to the latest firmware UI published on the official website.

3. About the User Interface

3.2 File

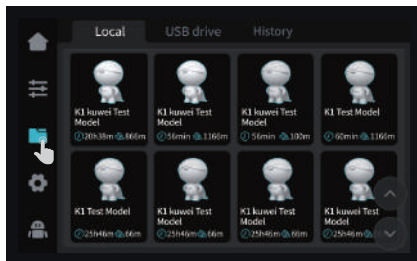

① Local file

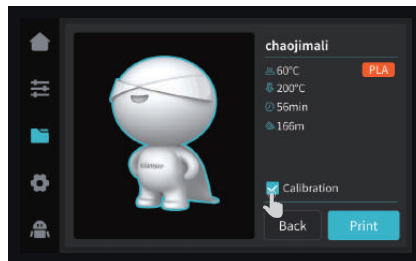

② Printing



③ Press and hold on the model to multi-select and copy it to a USB flash drive

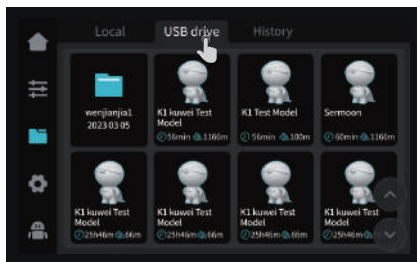

④ USB flash drive file

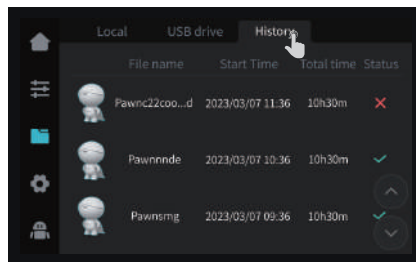

⑤ History



Note: The current interface is for reference only. Due to the continuous upgrading of functions, it shall be subject to the latest firmware UI published on the official website.

3. About the User Interface

3.3 Settings、Support

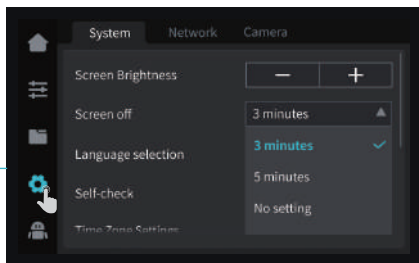

System settings

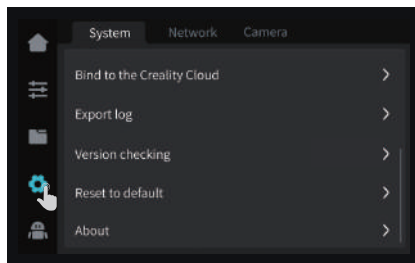

System settings

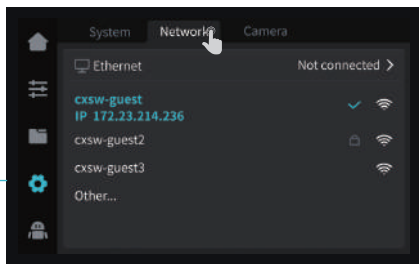

Network settings

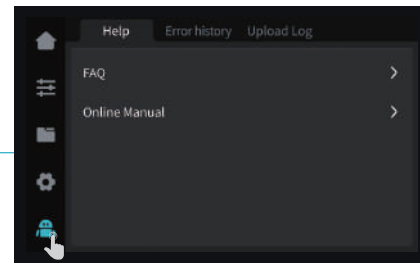

Help

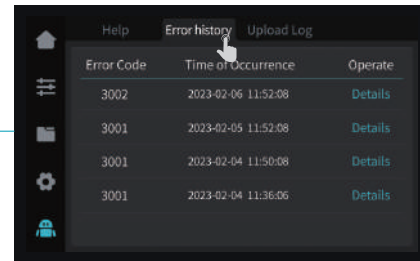

Error history

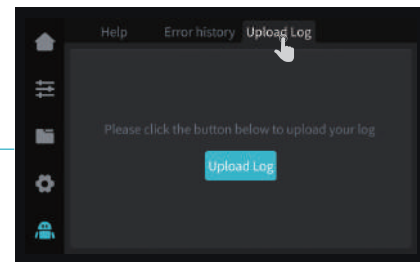

Upload Log

Settings

Support



Note: The current interface is for reference only. Due to the continuous upgrading of functions, it shall be subject to the latest firmware UI published on the official website.

4. First Printing

4.1 Local Printing

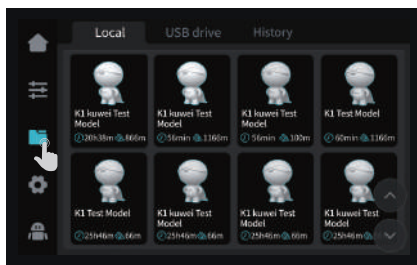

① Local model

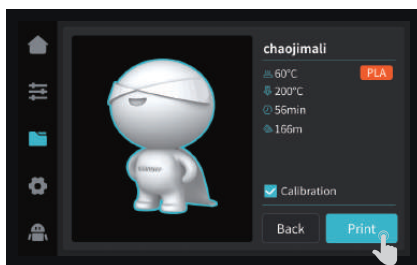

② Select to print

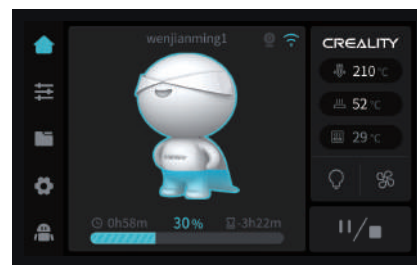

③ Printing



Note: The current interface is for reference only. Due to the continuous upgrading of functions, it shall be subject to the latest firmware UI published on the official website.



Note: Keep the Extrusion switch off before printing.

4. First Printing

4.2 LAN Printing

Creality Print



① Download at (www.crealitycloud.com) or find the software on a USB flash drive and install it.



Tips: the computer must be in the same local area network as the printer

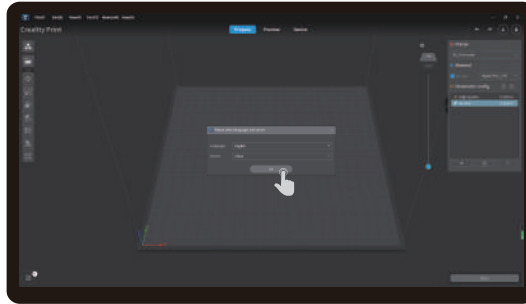

② Choose a language and region

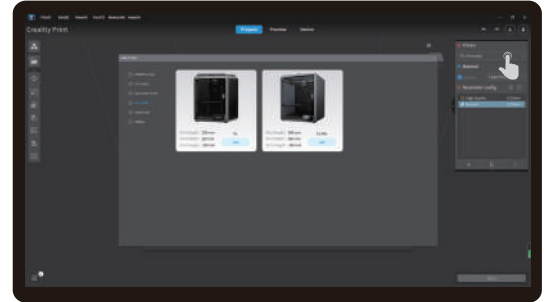

③ Choose a Printer

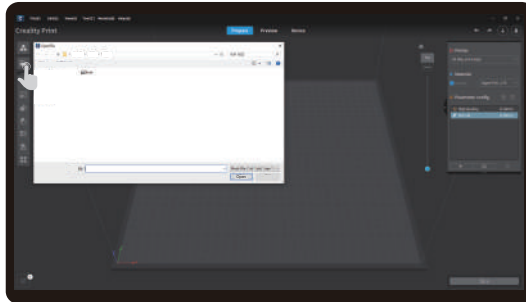

④ Click on "Import Model" and select the model file

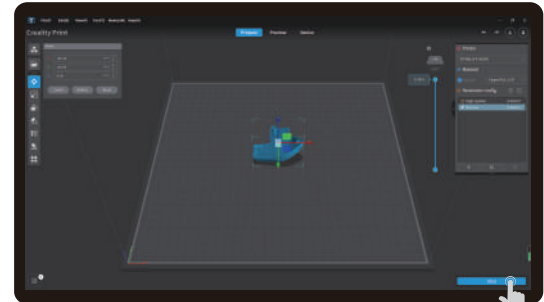

⑤ Open the model and click on "Slice"



Note: The current interface is for reference only. Due to the continuous upgrading of functions, it shall be subject to the latest firmware UI published on the official website.

4. First Printing

4.2 LAN Printing

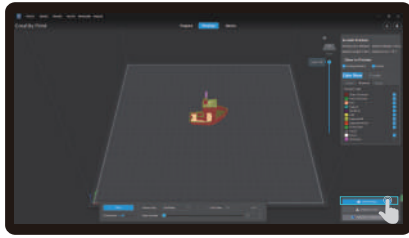

⑥ Selection of LAN printing

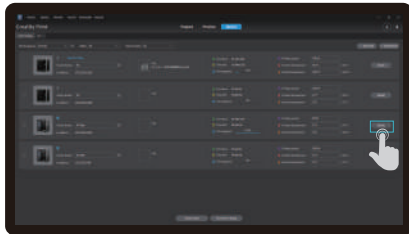

⑧ Device List

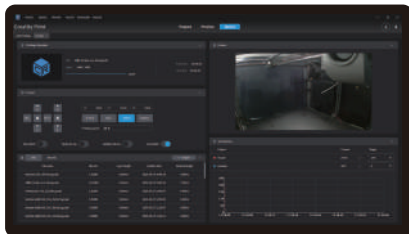

⑨ Device Details

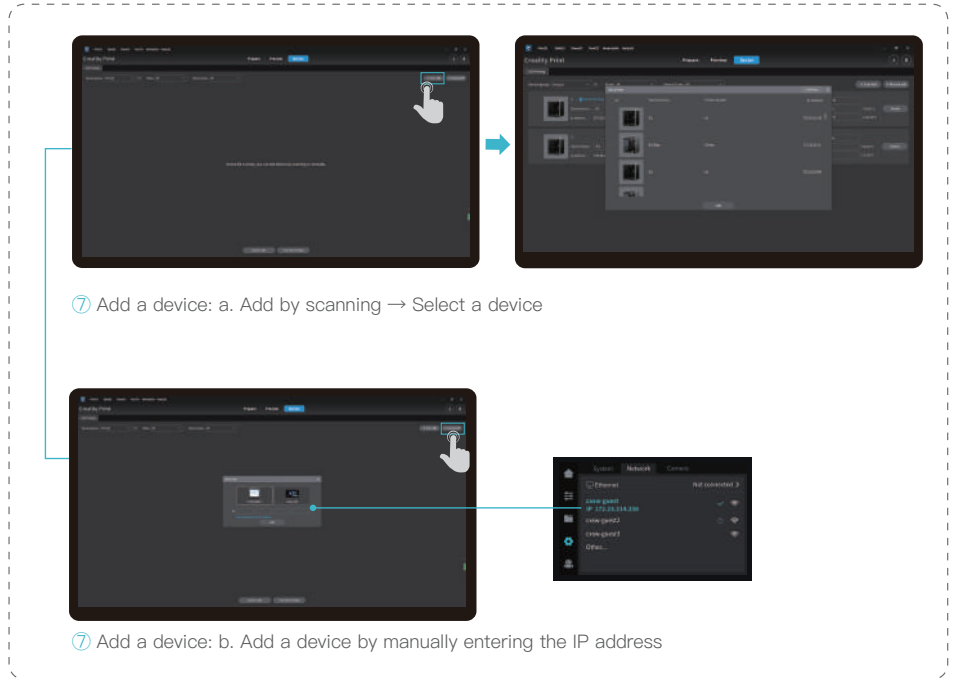

4. First Printing

4.3 CrealityCloud printing



1. Scan the QR code and download the app

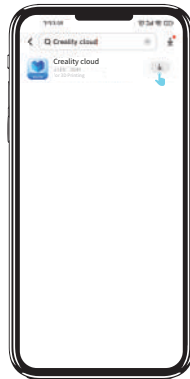

2. Download

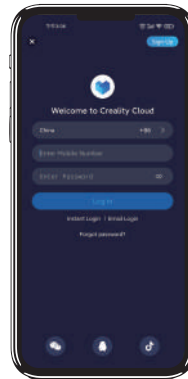

3. Sign up for an account

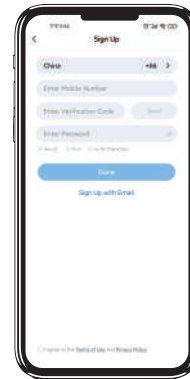

4. Log in

4. First Printing

4.3 CrealityCloud printing

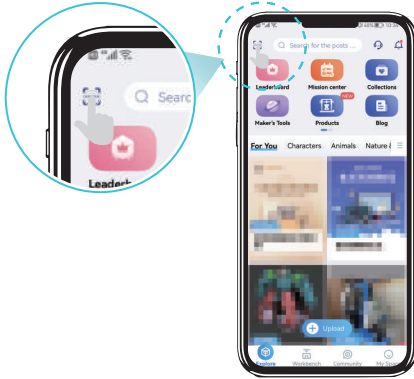

5. Add a new device



6. Add a device

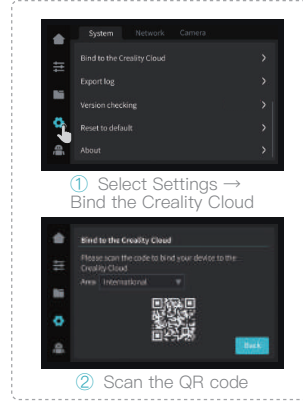

① Select Settings → Bind the Creality Cloud

② Scan the QR code

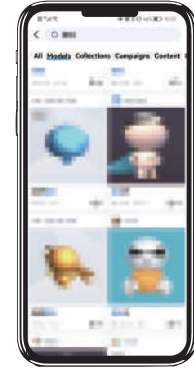

7. Select model on the homepage



8. Slice

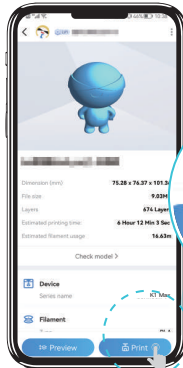

9. Print



10. Select a device

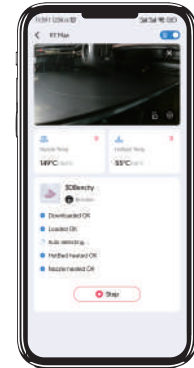

11. Printing

5. Functional Specification

5.1 Filament Retreat

Method 1:

① Input the nozzle temperature on the screen and wait for it to heat up to the target temperature.

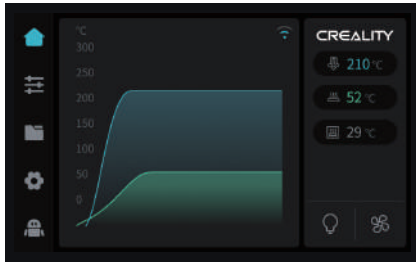

- ② Unlock the extrusion switch.
- ③ Remove the filament from the extruder.
- ④ Remove the PTFE tube from the top of the extruder.

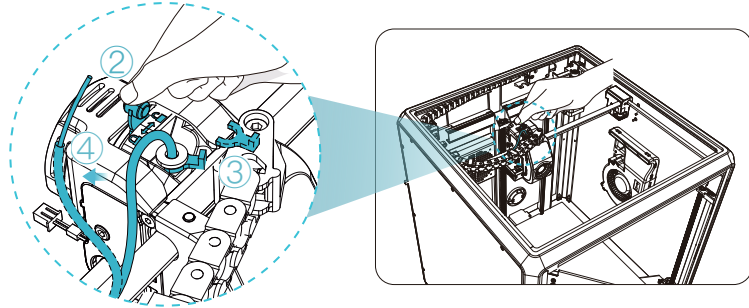

⑤ Extract the filament from outside the printer.

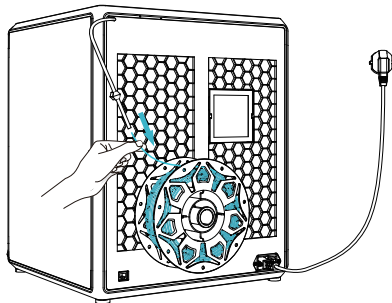

Note: The current interface is for reference only. Due to the continuous upgrading of functions, it shall be subject to the latest firmware UI published on the official website.

5. Functional Specification

5.1 Filament Retreat

Method 2:

① Click on the “Retract” button.

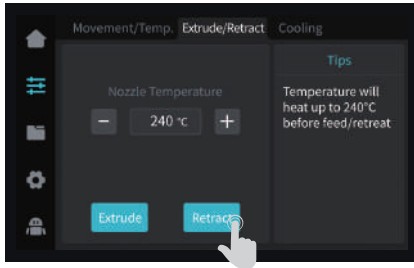

② Wait for the screen to display “Finish”.

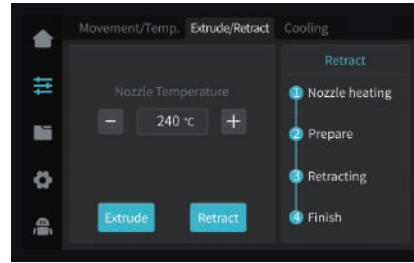

③ Extract the filament from outside the printer.

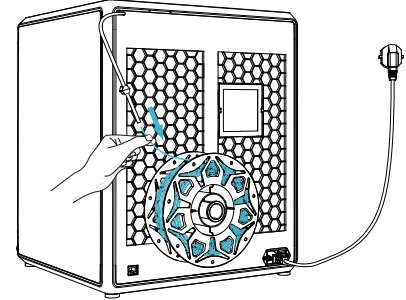

Note: The current interface is for reference only. Due to the continuous upgrading of functions, it shall be subject to the latest firmware UI published on the official website.

5. Functional Specification

5.2 Change filament

① Trigger filament runout sensor, click “refill”.

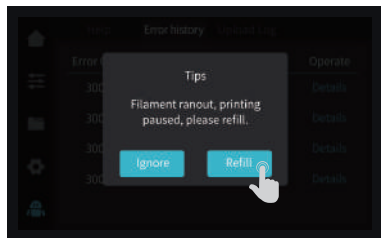

② Return to the print interface and reheat the nozzle to the extrusion temperature.



③ Unlock the extrusion switch.

④ Remove the PTFE tube and filament from above the extruder.

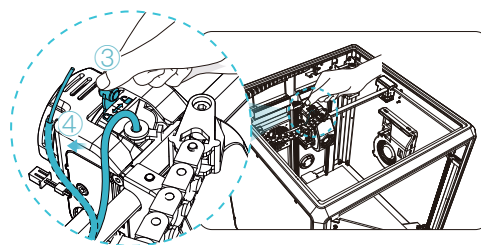

⑤ Completely remove the filament from the PTFE tube.

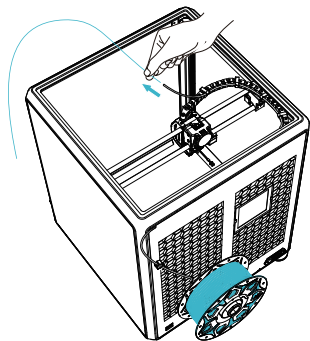

⑥ Insert the filament from the outside until it comes out of the other end of the PTFE tube.

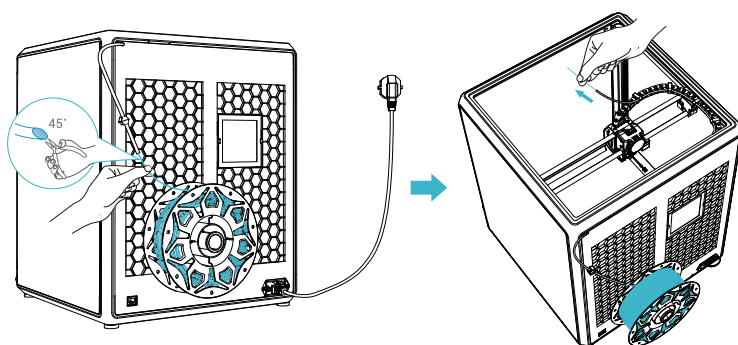

5. Functional Specification

5.2 Change filament

⑦ Insert the filament from the top until some filament flows out from the nozzle.

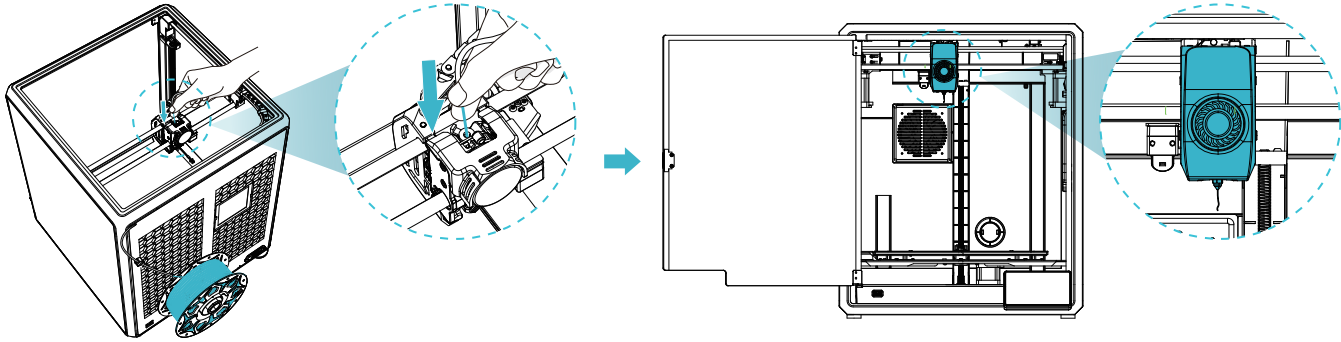

⑧ Lock the extrusion switch. ⑨ Restore the PTFE tube to its original position.

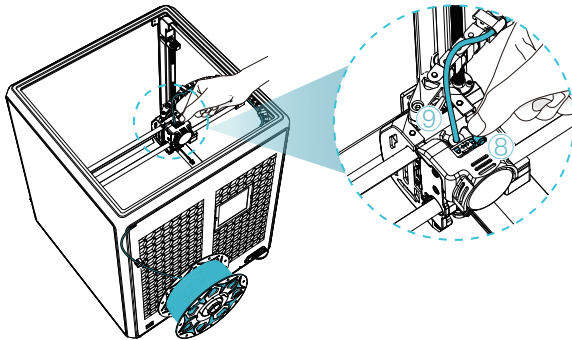

⑩ Resume the printing process.

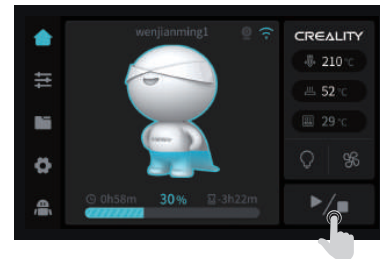

5. Functional Specification

5.3 Calibration

Select Calibration, the printer will be leveled before printing the model.

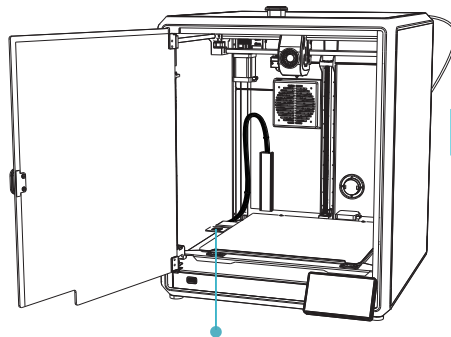

Calibration plate sticker



Note:

1. Ensure that the calibration plate sticker is clean and undamaged.
2. Do not stare directly at the laser when it is activated.

First-layer detection of printing:

Use AI Lidar and first-layer detection algorithm to check the first layer of the model to be printed, and report any first-layer quality problem found to the system, so as to prevent printing failure due to first-layer printing problems and to avoid wasting a lot of time and materials.

AI LiDAR:

- ① It's composed of laser and sensor. The laser is used to detect the surface of the measured object;
- ② The sensor is used to record the changes and generate point cloud data for the control system to call and process;
- ③ It's available to be applied to first-layer detection of printing.

5. Functional Specification

5.4 AI function

- ① When AI detection is turned on, the chamber camera will monitor the process of printing. If any defect is found during the printing, a window will pop up to remind you.
- ② When you check the Push Pause Printing, the printing will pause if there is any printing defect.

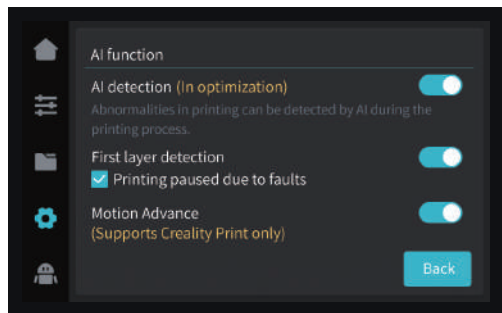

Motion advance: Motion advance is utilized to improve the printing quality by compensating for the delay in the mechanical system response during changes in printing direction. By anticipating the movement of the printer's extruder, motion advance ensures that the extrusion is accurately aligned with the intended path, reducing the occurrence of imperfections such as blobs or gaps in the printed model. This feature adjusts the extrusion rate based on the printer's motion, resulting in smoother and more precise prints.

After printing starts, if there are foreign objects on the platform or the previous printed model is not removed, the printer will pause printing and give a reminder. (To avoiding damaging the extruder) After turning off the first-layer detection, the first-layer detection will not be performed during the calibration.

Note: Push pause printing if Any Fault is effective for both the AI detection and first-layer detection.

5.5 Self-check

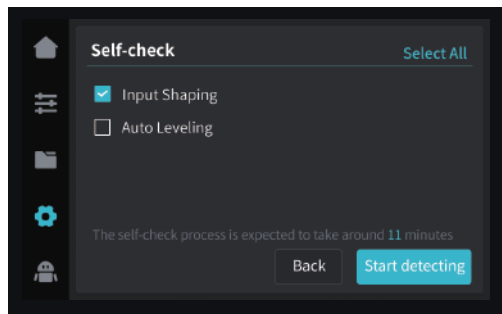

Input Shaping:

Ringings refer to the corrugated unevenness on the surface of the model that may be caused by the resonance of the machine or the action of external forces during the printing process.

To solve this problem, the input shaping sensor is used to actively obtain the resonance frequency of the 3D printer, and algorithm is applied to correct this state to achieve the purpose of eliminating the model chatter marks. Using the input shaping can effectively suppress the machine vibration and improve the printing quality of the model to obtain a smooth model surface.

5. Functional Specification

5.6 Network Settings

5.6.1 Wired connection

When the printer is connected to the network cable, you can click Settings → Local Network on the screen to check whether it is connected.

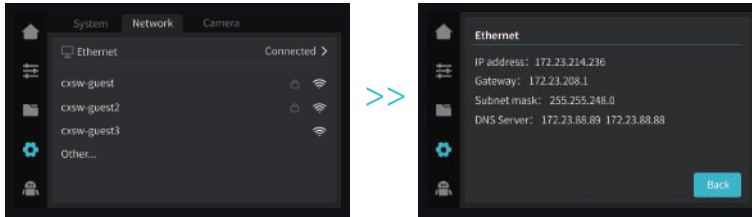

5.6.2 WIFI connection

In the screen click on Settings → Network → Connect WIFI, select the corresponding WIFI enter the password to complete the wireless network connection (only support 2.4GHz band).

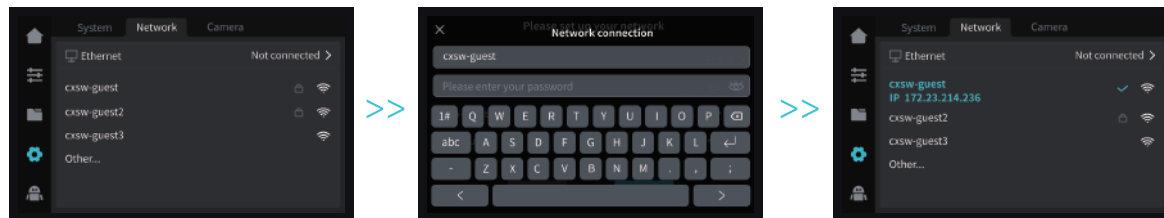

6. Tips and Routine Maintenance

6.1 Precautions for printing

6.1.1 Lubrication and maintenance

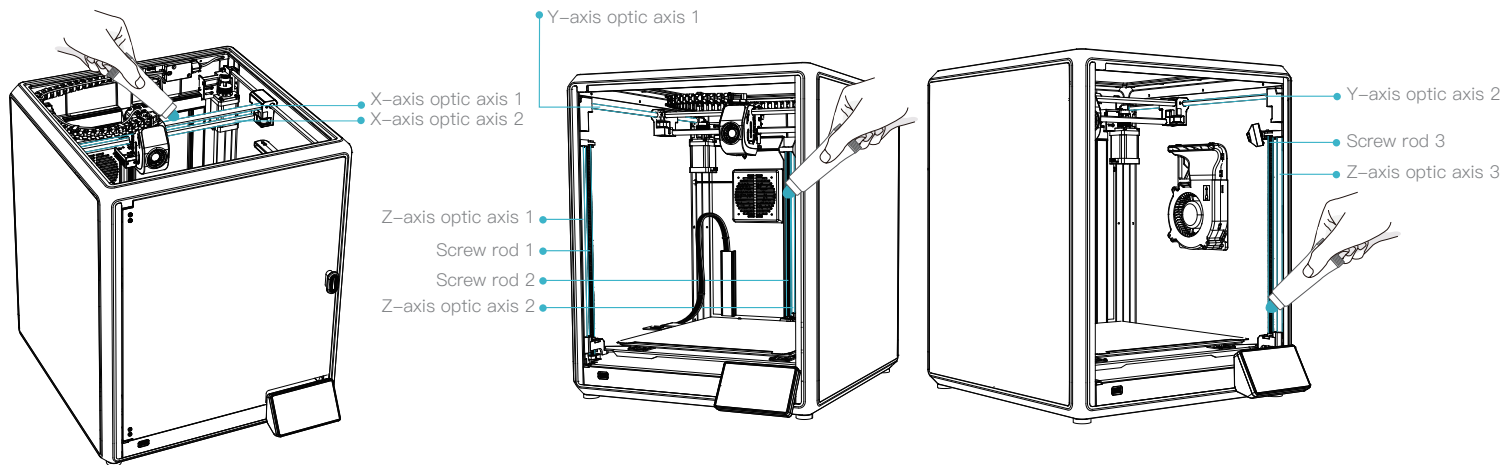

Regular maintenance of 300 hours: Please regularly lubricate the blue area in the picture with oil for maintenance. The lubricating grease will only be applied to the middle part, then automatically apply evenly by motion. (Users may buy the grease themselves for machine maintenance.)

6. Tips and Routine Maintenance

6.1 Precautions for printing

6.1.2 Use and maintenance of flexible platform

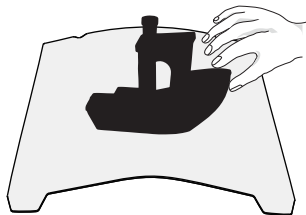

① Together with the flexible platform after the printed model has been cooled down Remove from the device and partially bend the platform slightly to separate the model from the platform.(No excessive bending of the platform to prevent it from being deformed and unusable)

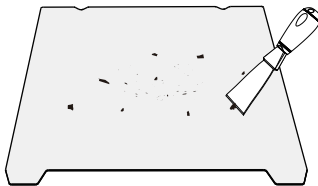

② The residue of the platform filaments can be scraped off with a blade. Be cautious of safety when using.

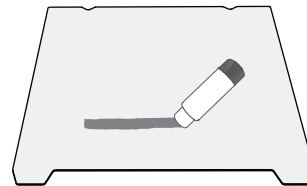

③ When the first layer of the model is not glued, it is recommended to apply glue stick evenly on the surface of the platform. The residual solid glue left after the printing can be cleaned with clean water.

6.1.3 Cleaning of debris inside the chassis

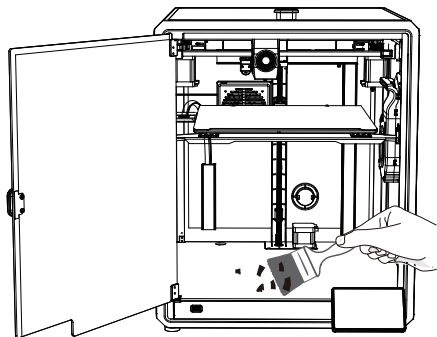

Reminder: When the printing time of the device exceeds 300 hours, or if the printing platform or nozzles have been replaced, the distance between the platform and nozzles may change that caused the first layer of the model may not stick firmly, resulting in printing failure. Please calibrate the platform regularly.



Reminder: Since the printing platform is quick-wear, it is recommended to replace the printing platform regularly to ensure that the first layer of the model is adhered.

6. Tips and Routine Maintenance

In the event that any of the above problems arise and cannot be resolved:

- ① Please visit <https://www.crealitycloud.com/product>, click “Products” and select the right model, and then click “Related” to view the tutorials on after-sales service;
- ② Or contact our after-sales service center at +86 755 3396 5666, or send e-mail to cs@creality.com.

6.2 Maintenance Items

	Maintenance instructions	
Machine cleanup	Clean the debris inside the machine to ensure that its operation is not affected.	Before each print
Hot end	Check if the wire output is normal, if not, please check if the extruder is blocked.	After each change of filaments
Printing platform	Check the surface of the platform for residual filaments and glue, if so, clean the surface of the platform.	Before each print
Motion mechanism	XYZ optic axis lubrication.	Cumulative print time per 300 hours
Air filtration	Replace the air filter cartridge.	Cumulative print time per 300 hours
Equipment self-test	Optimization of vibration veins.	Cumulative print time per 300 hours
	Auto Leveling.	
Filament replacement	Replacement of filaments of the same kind: follow the normal Retreat – Feed process.	/
	Replacement of different filaments: Preheat the nozzle to reach the target temperature of the current filament; then retreat it, replace with the target filament, and preheat the nozzle to the higher filament extrude temperature of the two filaments; feed for 30s until the filament has been completely extruded, and finally set the nozzle temperature to the temperature of current filament nozzle.	

6. Tips and Routine Maintenance

6.3 Installation of Damping Pads

The Damping Pads can improve the stability of printer during the printing. The specific installation method is as shown in the figure below:

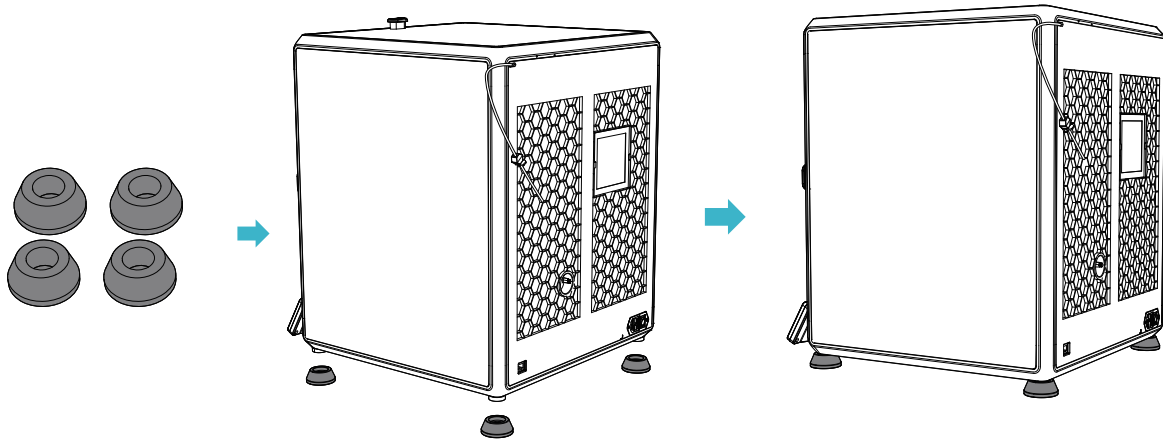

FCC Caution:

Any Changes or modifications not expressly approved by the party responsible for compliance could void the user's authority to operate the equipment.

This device complies with part 15 of the FCC Rules. Operation is subject to the following two conditions: (1) This device may not cause harmful interference, and (2) this device must accept any interference received, including interference that may cause undesired operation.

IMPORTANT NOTE:

Note: This equipment has been tested and found to comply with the limits for a Class B digital device, pursuant to part 15 of the FCC Rules. These limits are designed to provide reasonable protection against harmful interference in a residential installation. This equipment generates, uses and can radiate radio frequency energy and, if not installed and used in accordance with the instructions, may cause harmful interference to radio communications. However, there is no guarantee that interference will not occur in a particular installation. If this equipment does cause harmful interference to radio or television reception, which can be determined by turning the equipment off and on, the user is encouraged to try to correct the interference by one or more of the following measures:

- Reorient or relocate the receiving antenna.
- Increase the separation between the equipment and receiver.
- Connect the equipment into an outlet on a circuit different from that to which the receiver is connected.
- Consult the dealer or an experienced radio/TV technician for help.

FCC Radiation Exposure Statement:

This equipment complies with FCC radiation exposure limits set forth for an uncontrolled environment.

This equipment should be installed and operated with minimum distance 20cm between the radiator& your body.

Since each model is different, the actual product may be different from the picture. Please refer to the actual product.
The final interpretation right belongs to Shenzhen Crealty 3D Technology Co., Ltd.



SHENZHEN CREALTY 3D TECHNOLOGY CO., LTD.

Add:18th Floor, JinXiuHongDu Building, Meilong Road, Xinniu Community,
Minzhi Street, Longhua District, Shenzhen City, China.

Official Website: www.crealty.com

Tel: +86 755-8523 4565

E-mail: cs@creality.com



R 214-230089