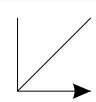
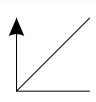
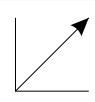

Шкаф / wardrobe VICTOR

Код ТН ВЭД ЕАЭС

9403 60 100 1
9403 90 300 0

отрезать
и приклеить

		
800	1824	510

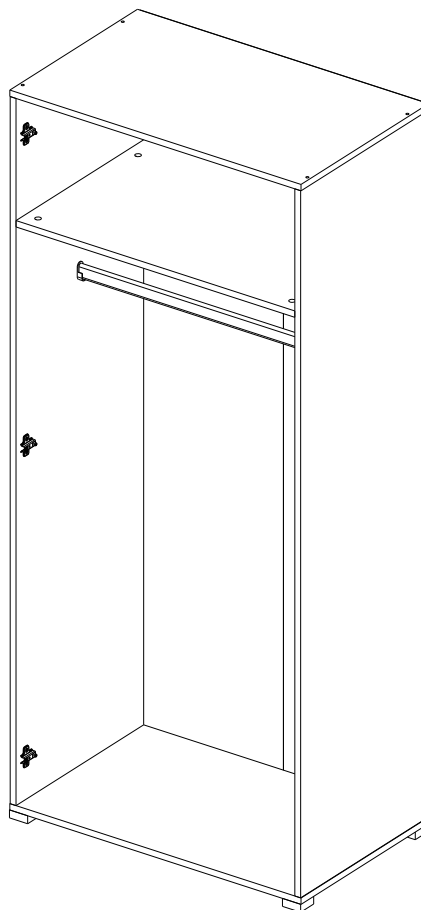
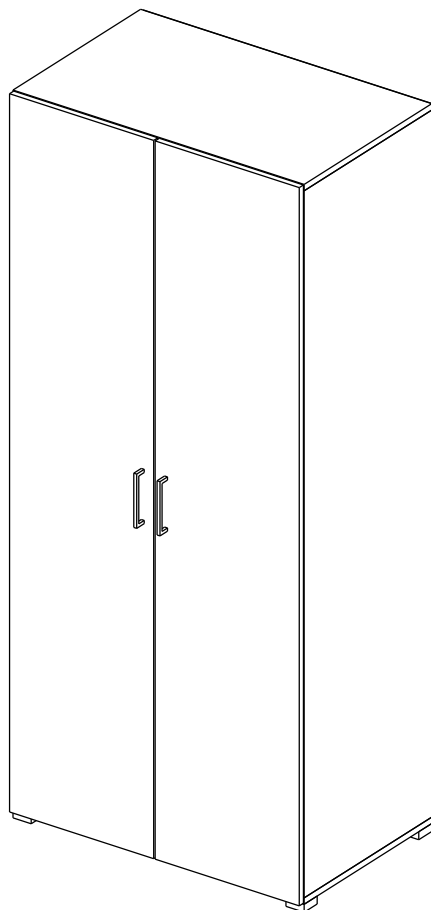

36ШВСС / 3066
36ШВСБ / 3028
36ШВББ / 3067
36ШВБТ / 3068

Комплектовочная ведомость / Set package sheet

Упак/ Package	Наименование	Description	Цвет детали/ Décor				Размер / Size, mm	Кол-во/ Quantity	№
			Sonoma	Sonoma- White	White	White- Concrete			
1	Боковина левая	Side left	Sonoma	Sonoma	White	White	490x1772	1	1
	Боковина правая	Side right	Sonoma	Sonoma	White	White	490x1772	1	2
2	Крыша	Top	Sonoma	Sonoma	White	White	800x490	2	3
	Вязка	Connecting element	Sonoma	Sonoma	White	White	766x490	1	4
	Штанга	Wardrobe tube	-	-	-	-	761 mm	1	7
	Фурнитура	Furniture/Cabinetry	-	-	-	-	-	1	-
3	Створка	Door	Sonoma	White	White	Concrete	396x1800	2	5
	ХДФ	Back element	White	White	White	Concrete	1800x397	2	6

(PL) Instrukcja montażu

(CZ) Návod k montáži

(D) Montageanleitung

(GB) Assembly instruction

(F) Model d'emploi

(HU) Szerelési útmutató

(I) Istruzione di montaggio

(NL) Handleiding voor de montage

(RU) Инструкция по монтажу

(RO) Instrucțiuni de montare

(SK) Návod k montáži

(TR) Montaj talimatı

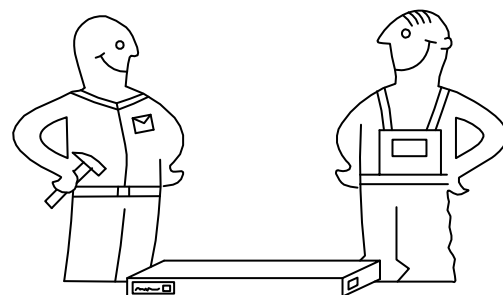



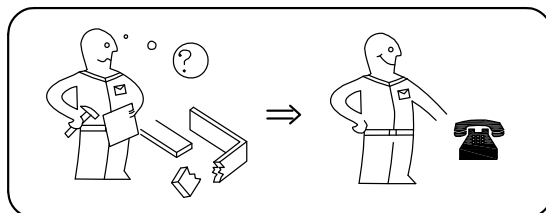



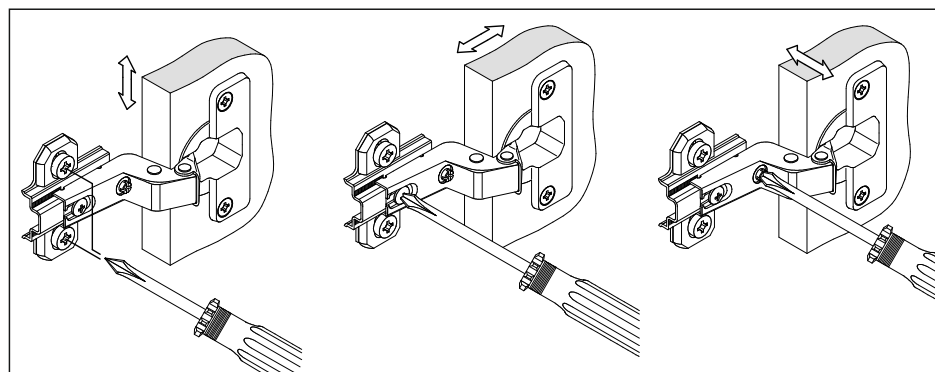
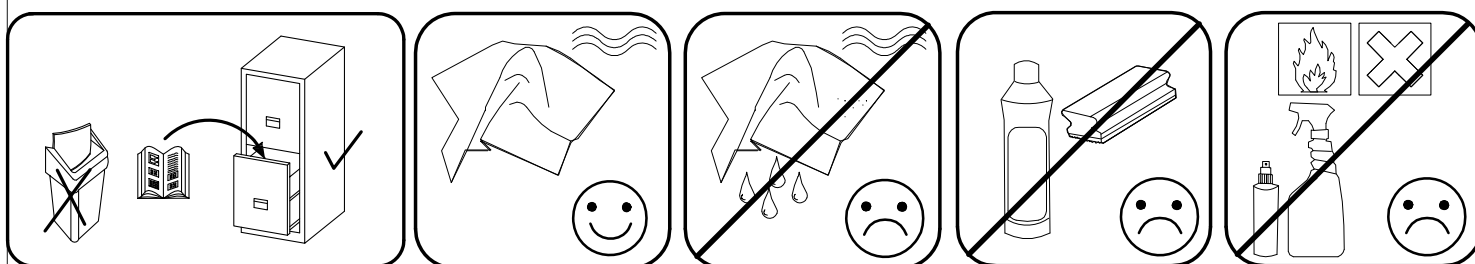

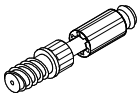

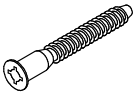
⚠ Uwaga • Upozornění • Achtung • Attention • Caution • Figyelem • Attenzione • Opgelet • Внимание • Atenție • Upozornenie • Dikkat ⚠	
PL	Czyszczenie należy wykonać wyłącznie za pomocą ściereczki lub lekko nawilżonego ręcznika. Nie stosować środków czyszczących do szorowania.
CZ	Čistění je nutné vykonávat výhradně pomocí utěrky nebo lehce navlhčeného ručníku. Nepoužívejte čisticí prostředky obsahující abrazivní částice.
D	Bitte nur mit einem Staubtuch oder leicht feuchtem Lappen reinigen. Keine scheuernden Putzmittel verwenden.
GB	Please only clean with a duster or a damp cloth. Do not use any abrasive cleaners.
F	Le nettoyage se fait uniquement à l'aide d'un torchon ou d'une serviette légèrement mouillée.
HU	A tisztítás kizárólag törölrőruha vagy enyhén nedvesített törölköző segítségével végezhető. Súroló hatású tisztítószerket nem szabad használni.
I	Pulire esclusivamente con un panno o un asciugamano umido.
NL	Reinig alleen met een stofdoek of een lichtjes vochtige doek. Gebruik geen schurende poetsmiddelen.
RU	Очищайте от пыли тряпкой или слегка влажной ветошью. Не допускается применение чистящих средств, не предназначенных для ухода за мебелью.
RO	Curățarea trebuie efectuată numai cu o cârpă sau cu un prosop ușor umezit. Nu utilizați agenți de curățare abrazivi.
SK	Čistení je nutné vykonávať výhradne pomocí utierky alebo ľahko zvlhnutým ručníkom. Nepoužívajte čistiace prostriedky obsahujúci abrazívni častice.
TR	Lütfen sadece bir toz beziyile veya hafif nemli yumuşak bir bezle siliniz. Aşındırıcı temizlik malzemeleri kullanmayınız.

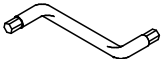

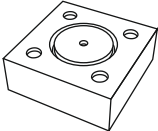
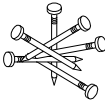
**Karta serwisowa • Servisní list • Service Karte • Service card • Carte de service • Szervizkártya
Scheda di servizio • Service kaart • Сервисная карта • Fisa service • Servisný list • Servis karti**

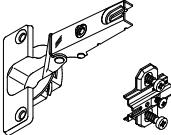
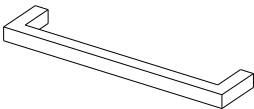

1		2		5	7x50	6	6,3x10,5	15	
									
4 x		4 x		8 x		12 x		1 x	
18	3,5x15	38		48	2x20	49		72	
									
32 x		4 x		50 x		2 x		4 x	
73		91	Hinge A	126	C42 128 mm				
									
4 x		6 x		2 x					

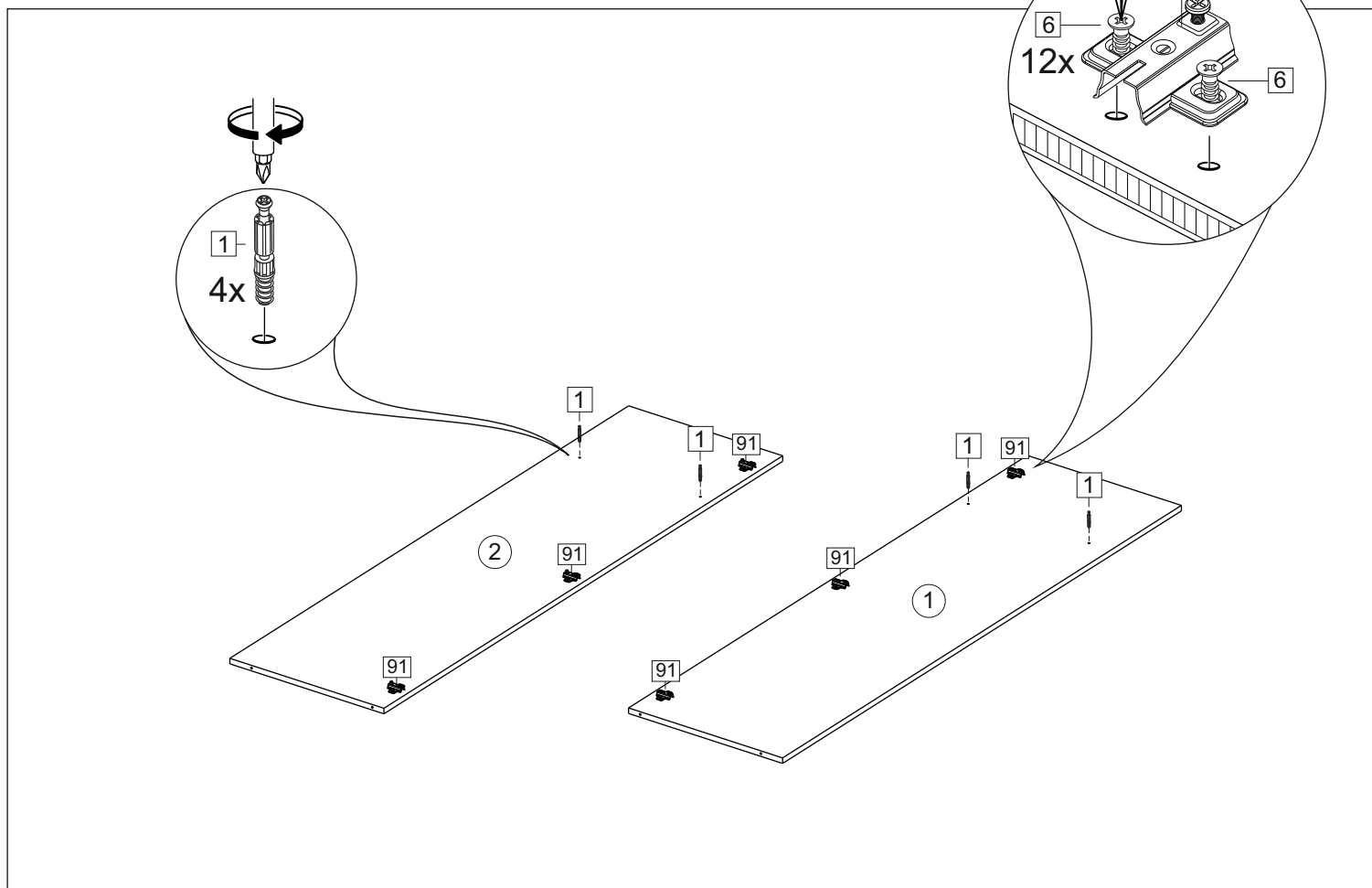

4

