



CREATOR



31058



[LEGO.com/creator](https://www.lego.com/creator)



WARNING: CHOKING HAZARD.
Toy contains small parts and a small ball.
Not for children under 3 years.



<https://tm.by>
Интернет-магазин



1

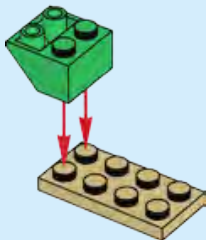

2



AVERTISSEMENT : RISQUE D'ÉTOUFFEMENT.
Le jouet contient des petites pièces ainsi qu'une petite boule.
Il ne convient pas aux enfants de moins de 3 ans.



ADVERTENCIA: PELIGRO DE ASFIXIA.
Juguete que contiene partes pequeñas y una pelota pequeña.
No recomendado para niños menores de 3 años.



2

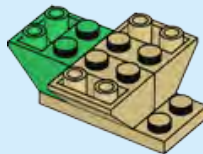



3

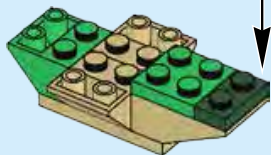

4

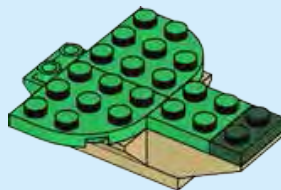

3



1x

5

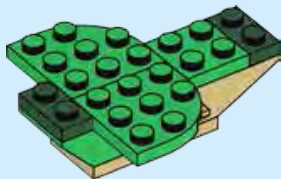

4



1x



1x

6

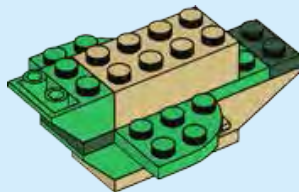

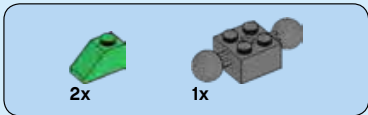

7

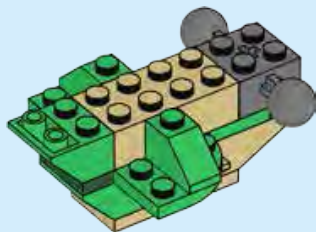

8

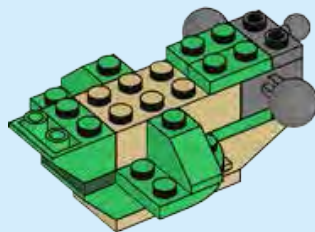

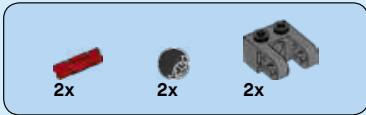

9

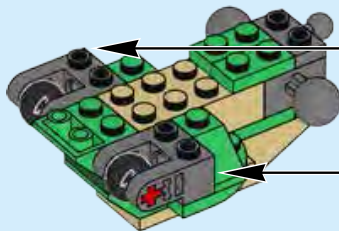
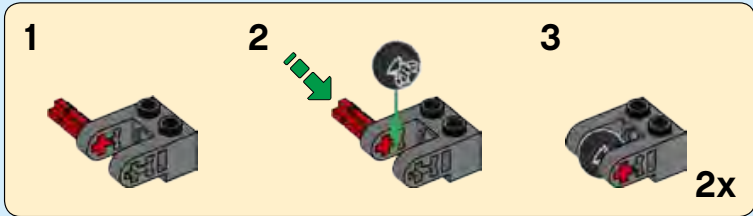

6



10

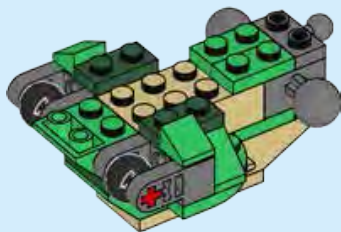

11

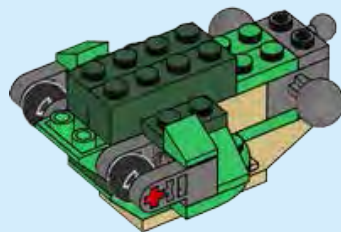



12

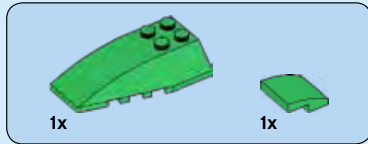
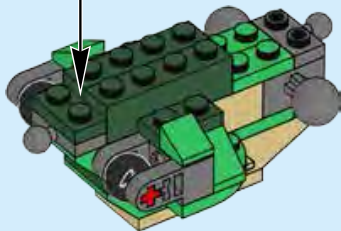
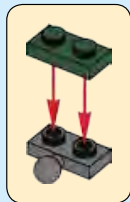

13

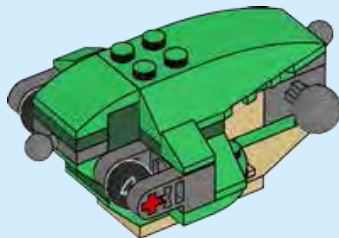

8



14

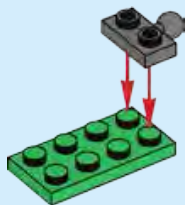

15



16

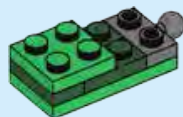



1x

17



10



2x

18

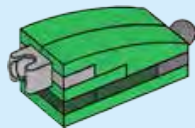

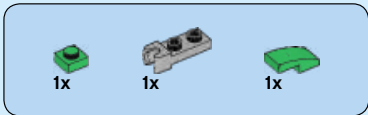

19

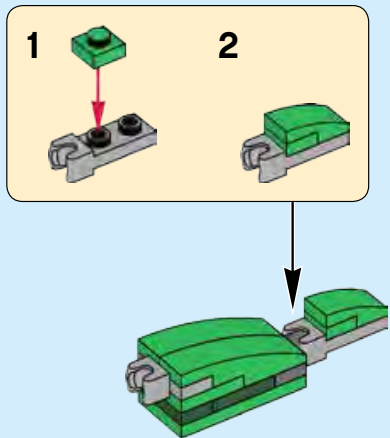

20

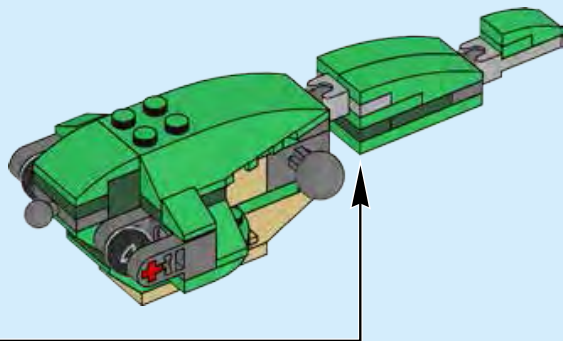



21

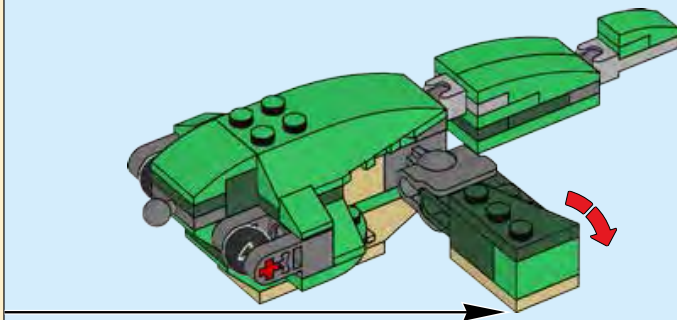
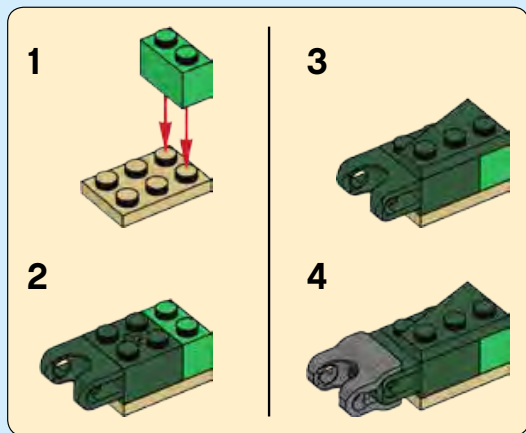

12



22

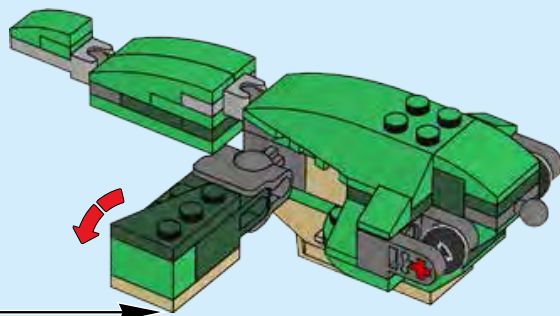
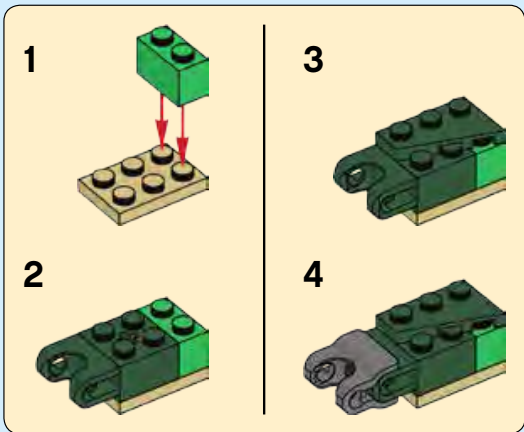
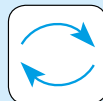

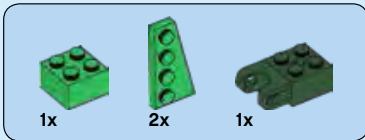

23

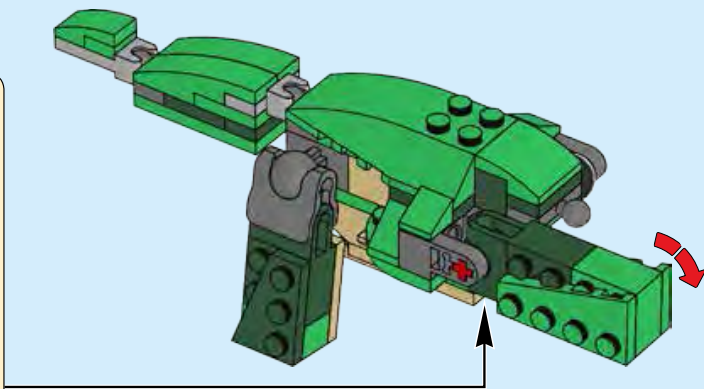
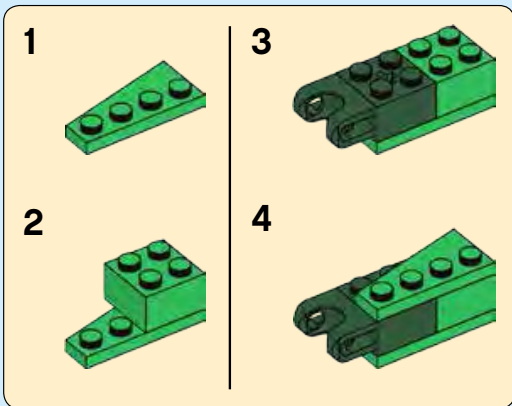

14

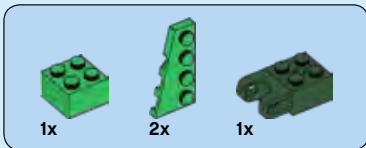

24

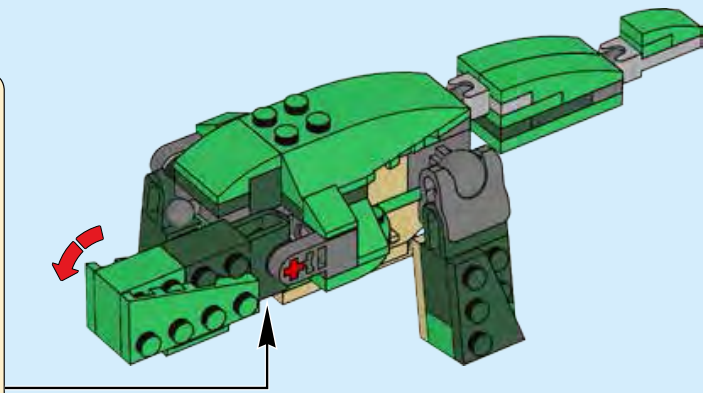
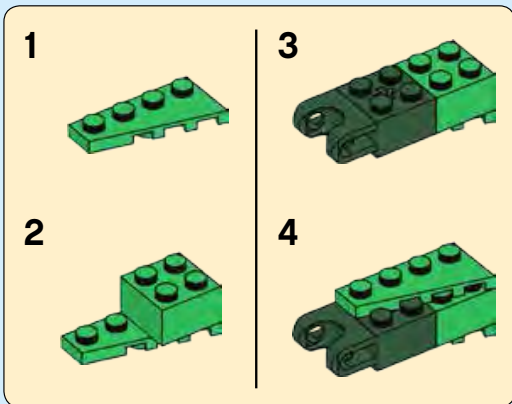
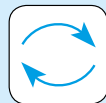

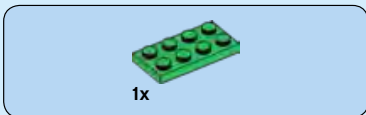

1x

25

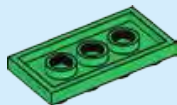

16



1x

26

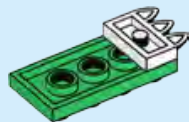



27

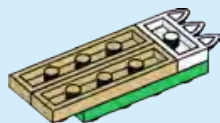

28

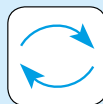



1x



2x

29

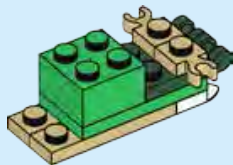

18



2x



2x

30

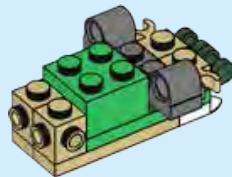



31

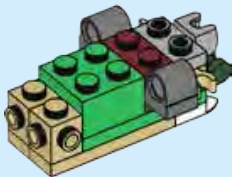

32

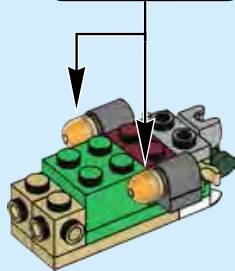
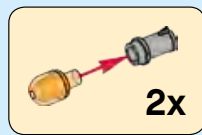



2x



2x



1x

33

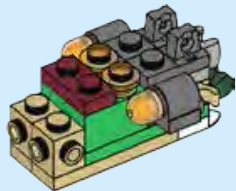

20



2x

34

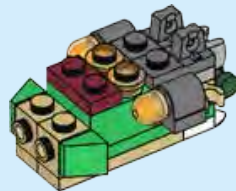



35

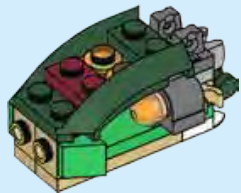

36

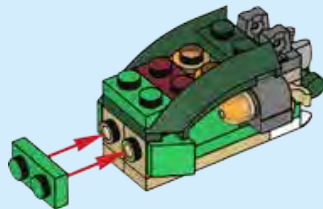

21



1x

37

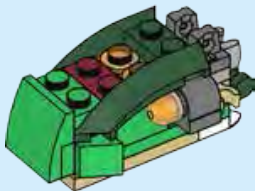

22



1x



1x

38

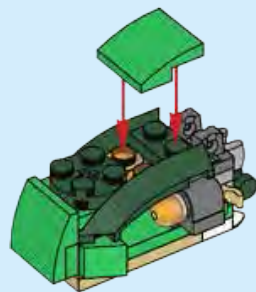

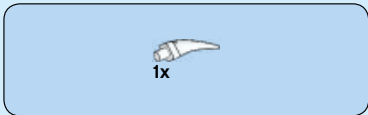

39

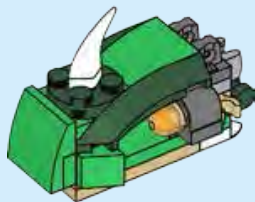

40

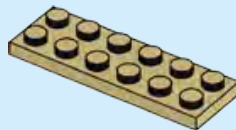



2x



2x

41

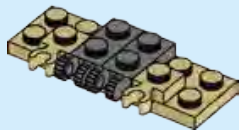

24



1x



1x

42

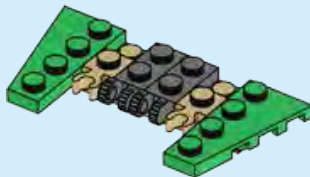



43

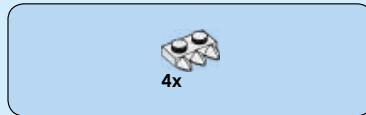
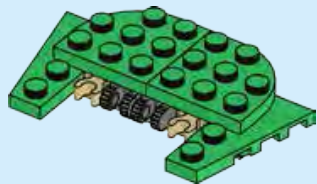

44

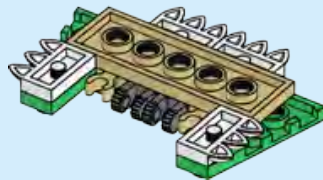
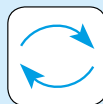

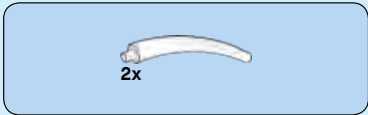

45

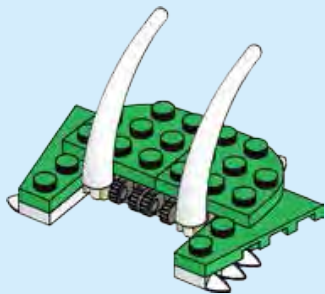

26

46

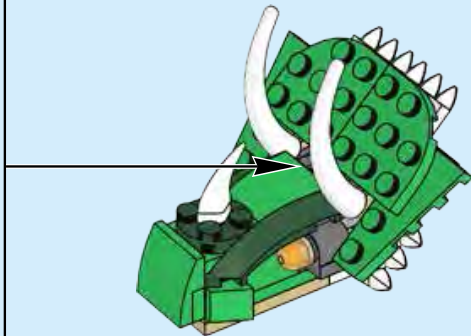

47

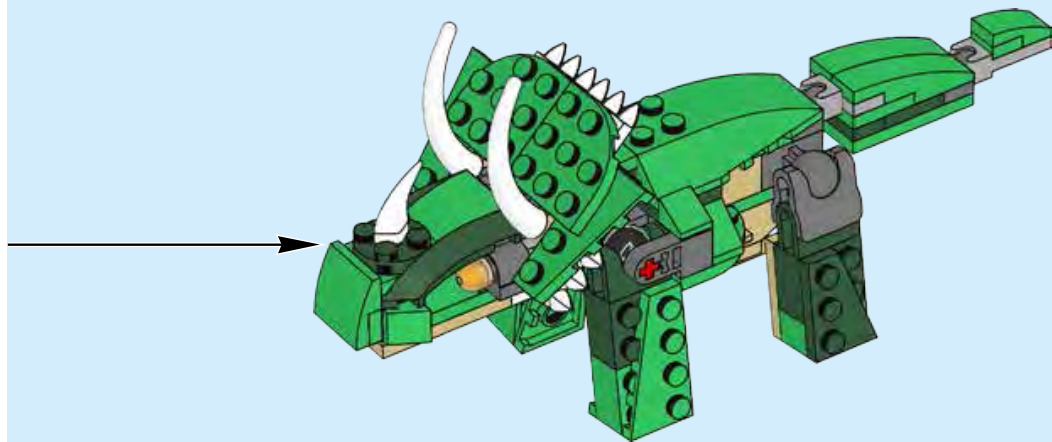



CREATOR



CREATOR ISLANDS

LEGO.com/creator

LEGO and the LEGO logo are trademarks of the/son des marques de commerce du/son marcas registradas de LEGO Group. ©2017 The LEGO Group.

Apple and the Apple logo are trademarks of Apple Inc., registered in the U.S. and other countries. App Store is a service mark of Apple Inc.

Google Play is a trademark of Google Inc.

Ask parents' permission first.
Demande d'abord l'autorisation d'un parent.
Pide antes permiso a tus padres.



Download on the
App Store

ANDROID APP ON
Google play



6201556

TM!
ONLINE STORE

<https://tm.by>
Интернет-магазин