

11

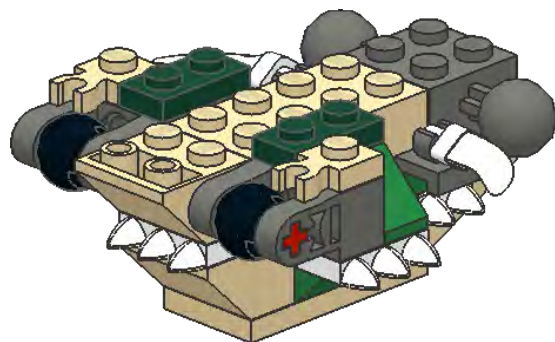

12

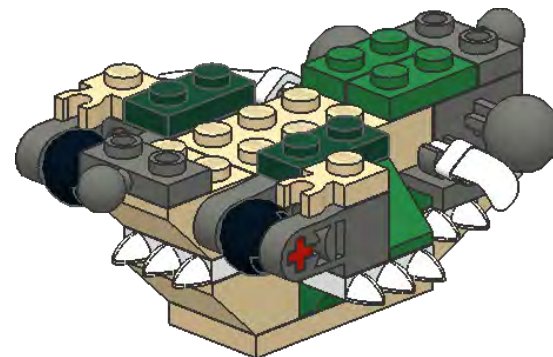

13

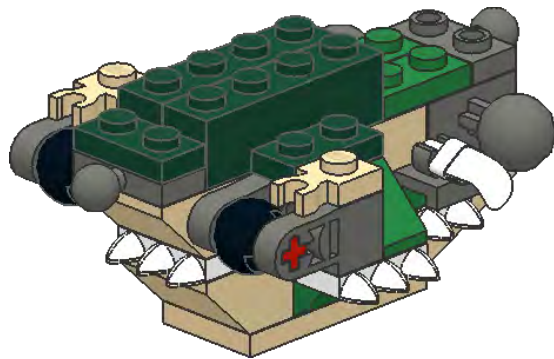
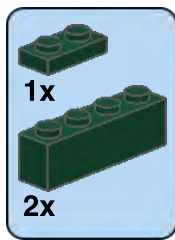

14

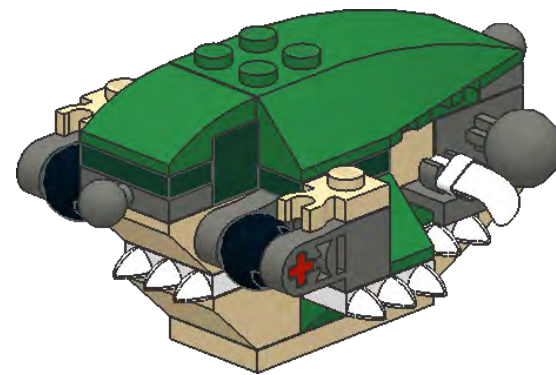
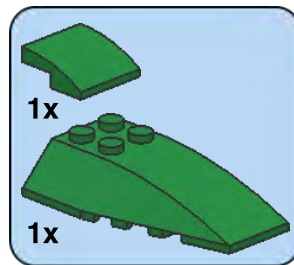

1

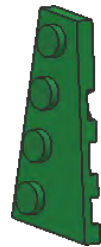
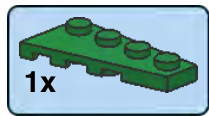

2

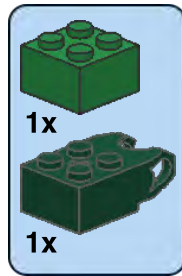

3

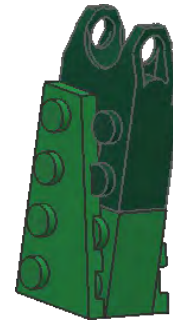
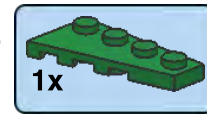

15

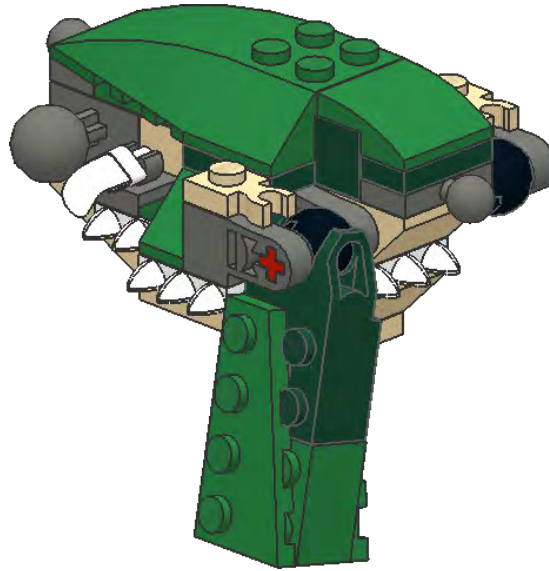

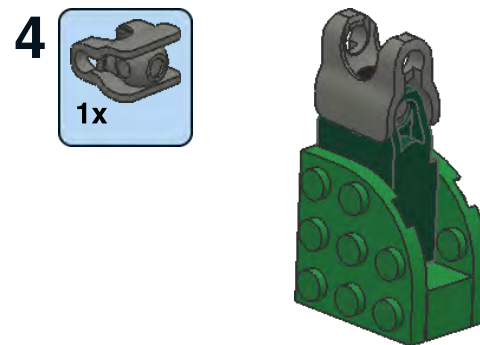
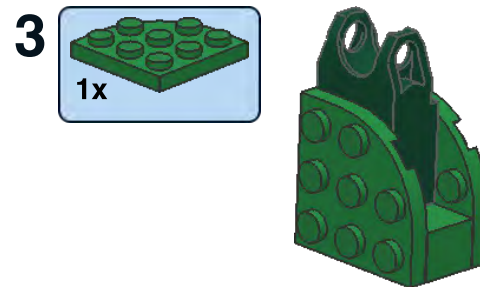
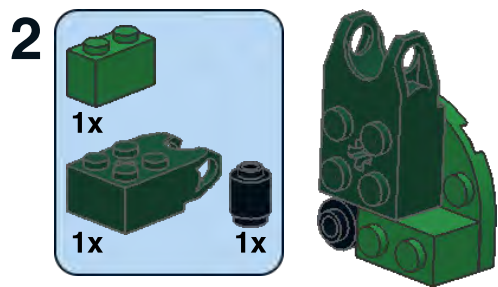

16

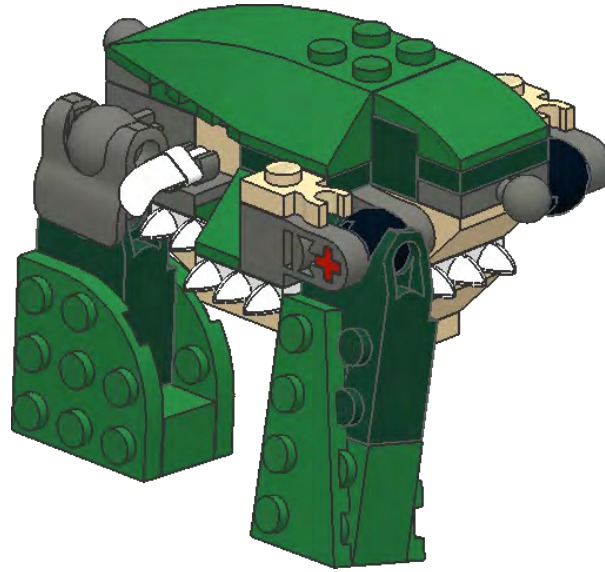

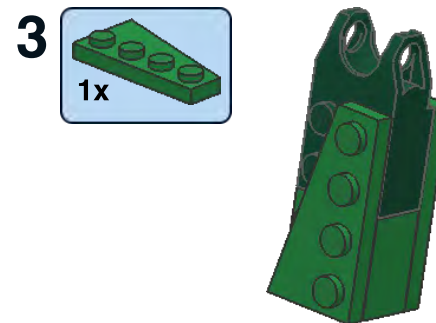
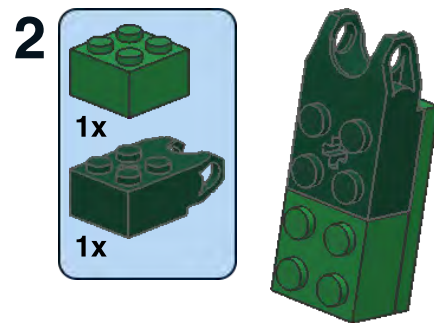
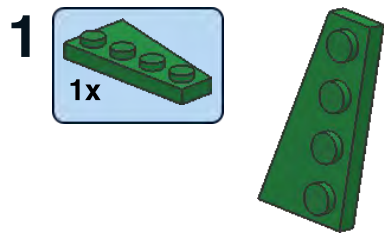

17

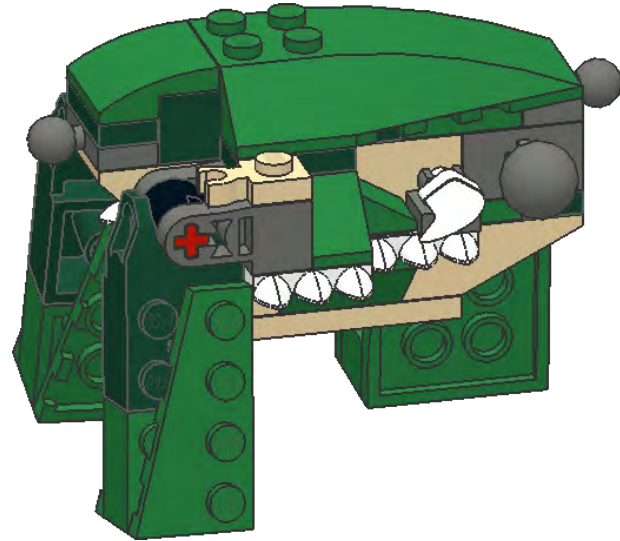

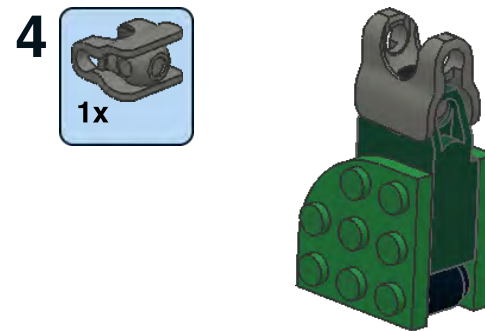
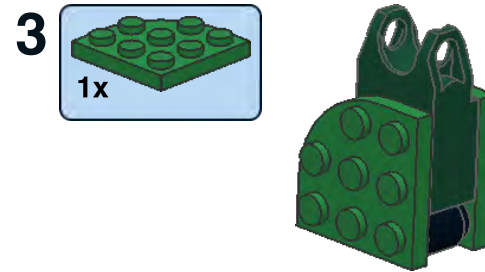
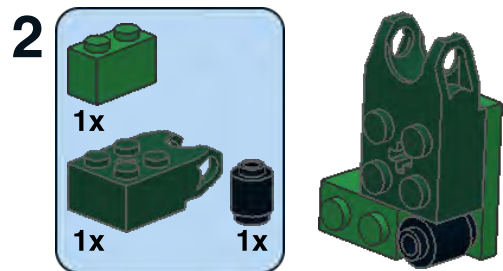

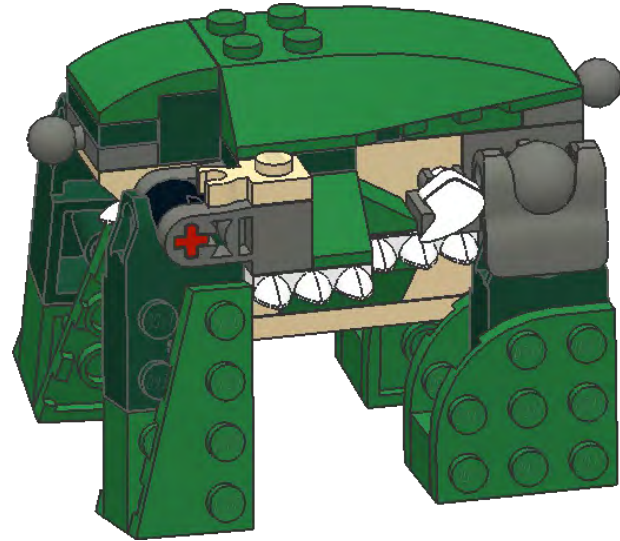

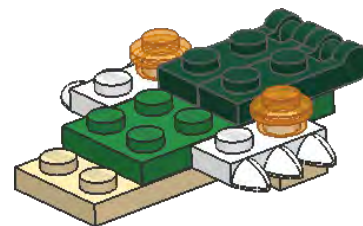
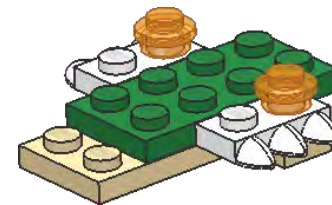
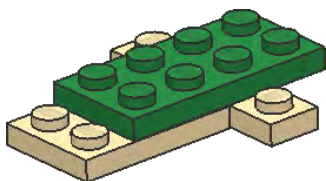
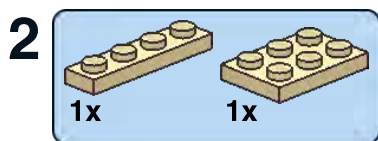
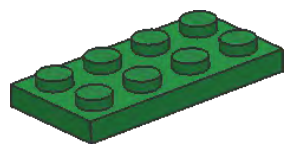
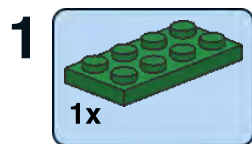

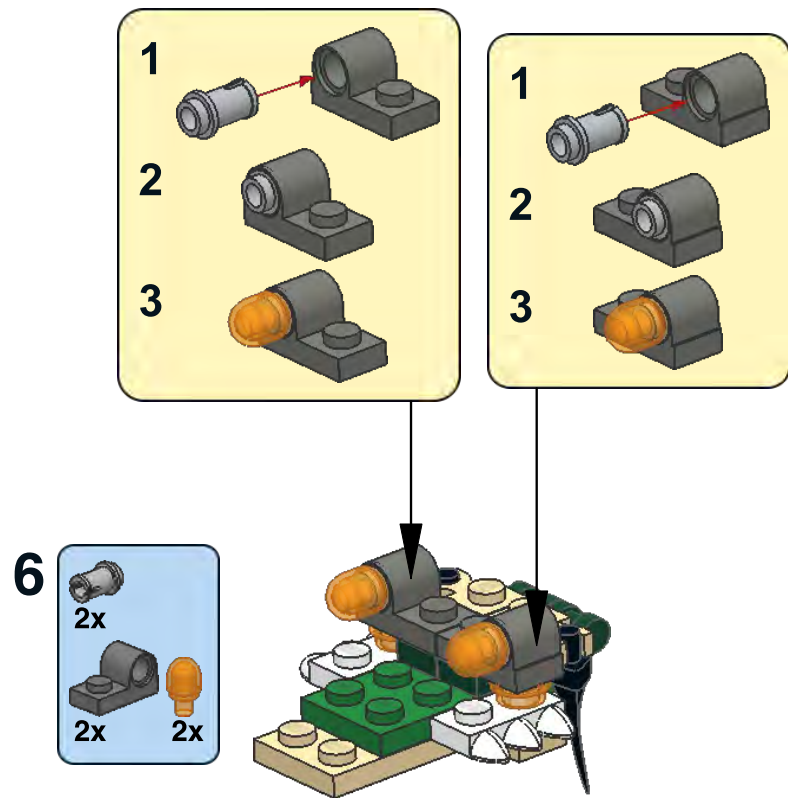
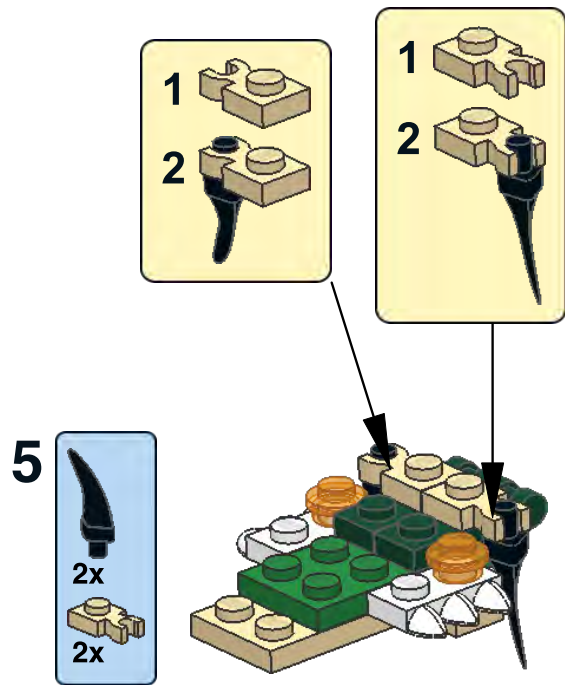

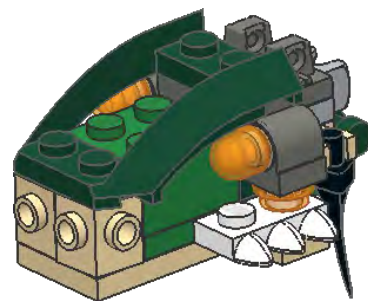
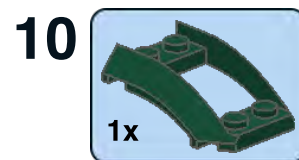
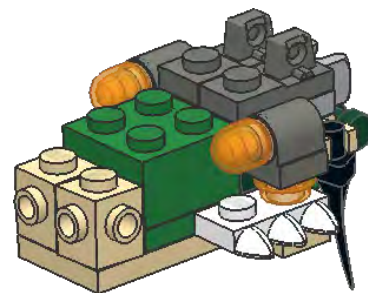
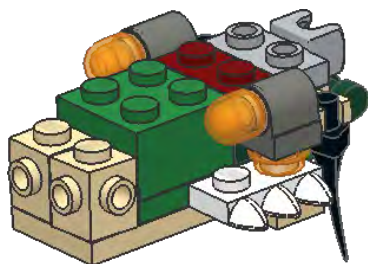
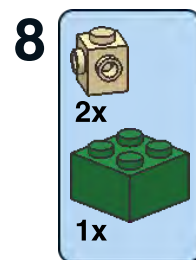
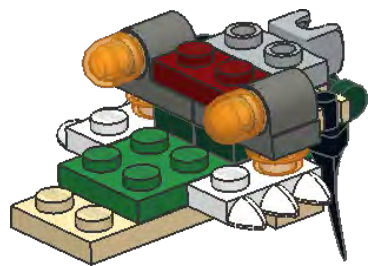

11
1x

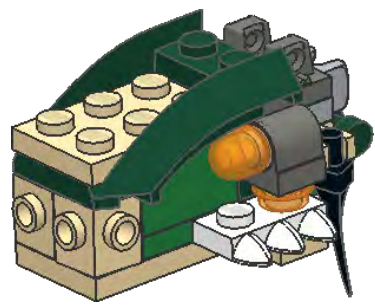

12
1x
1x

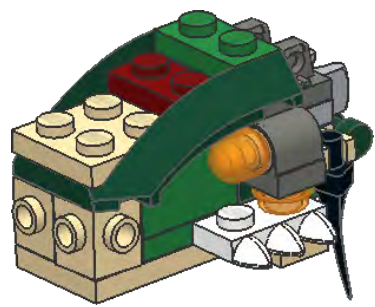

13
2x

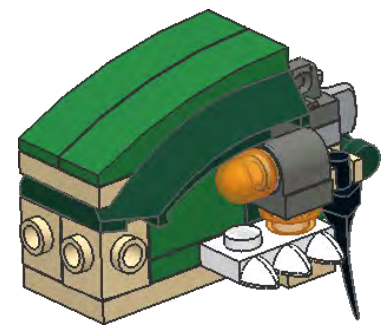

14
2x
1x

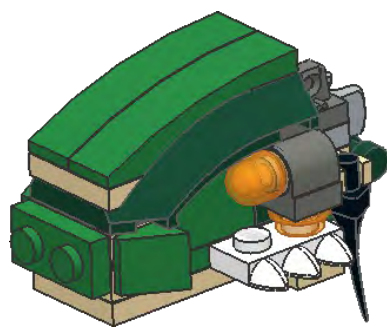

15
1x

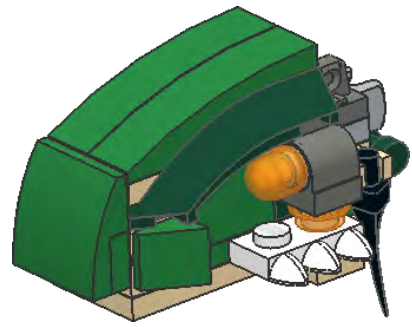

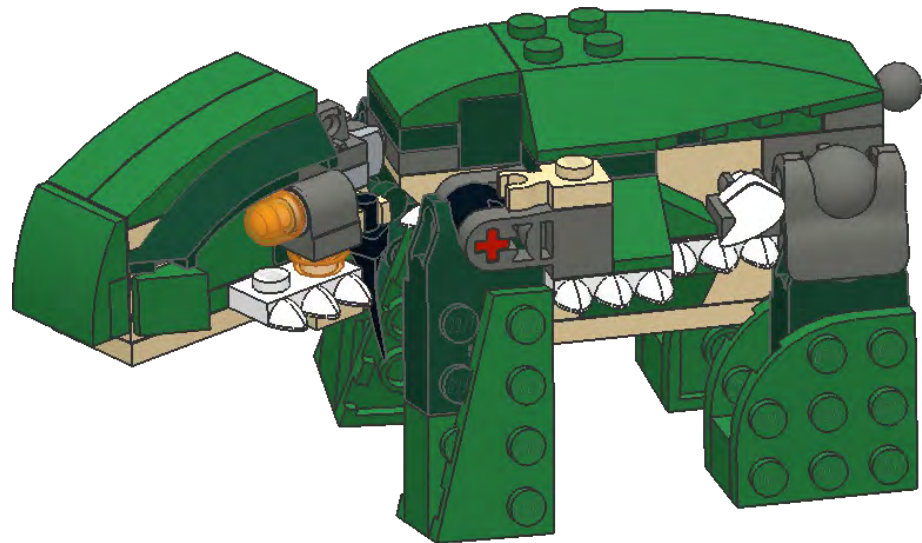

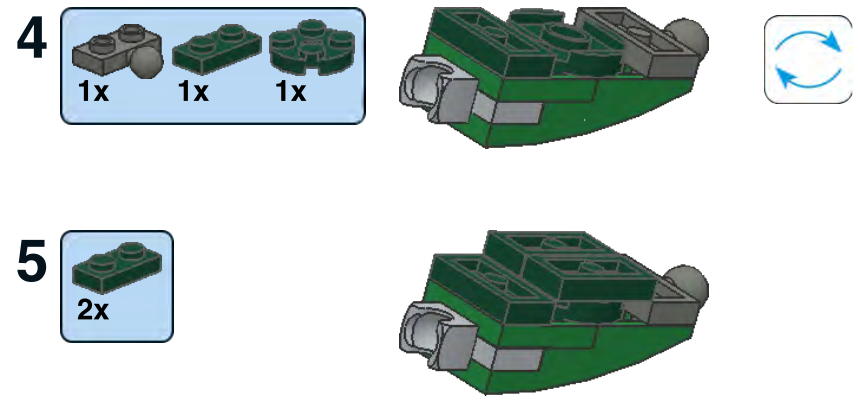
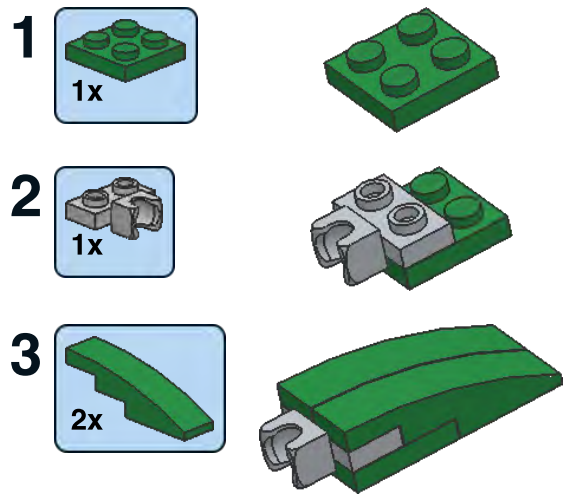

6

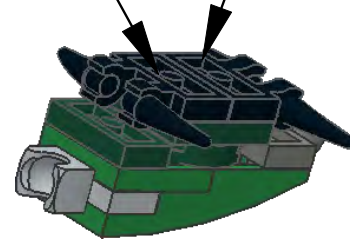
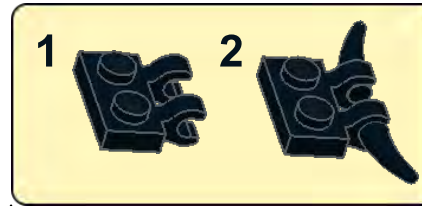

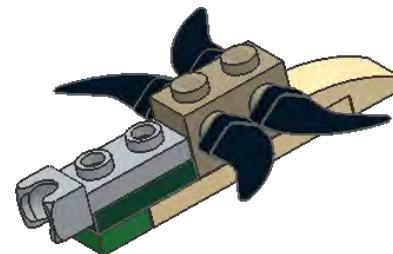
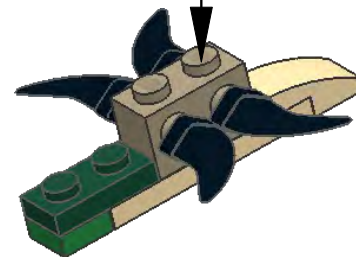
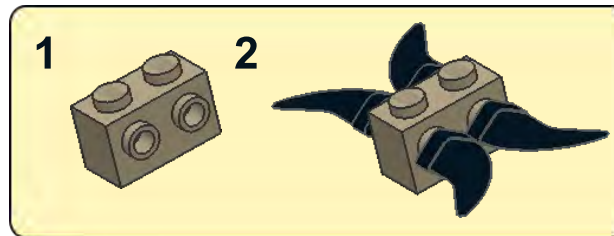
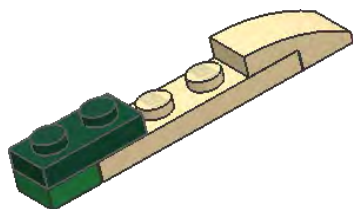
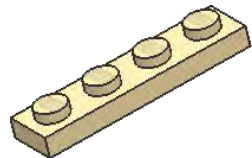
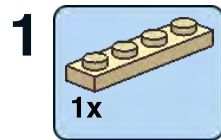

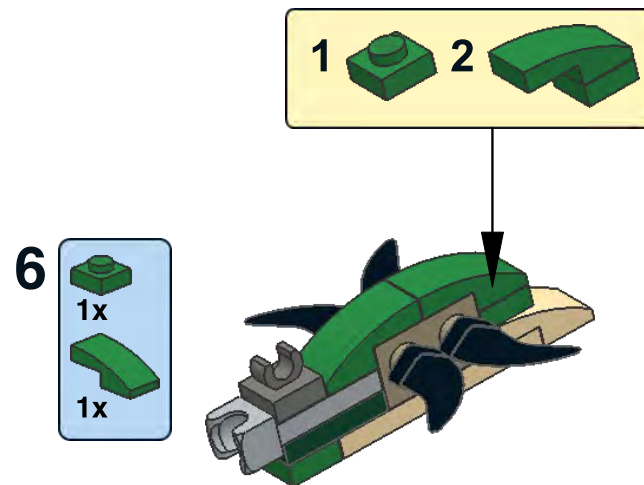
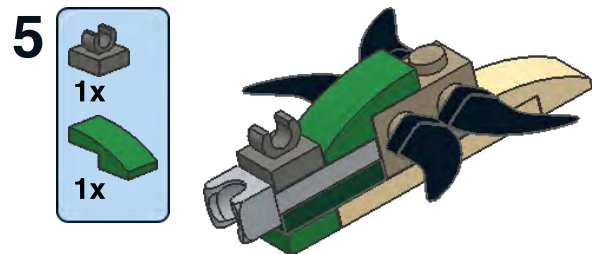

7

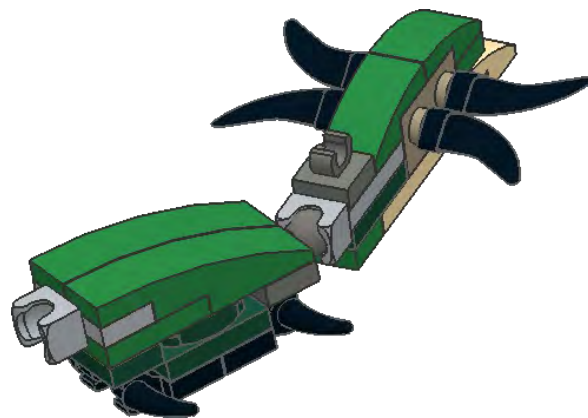

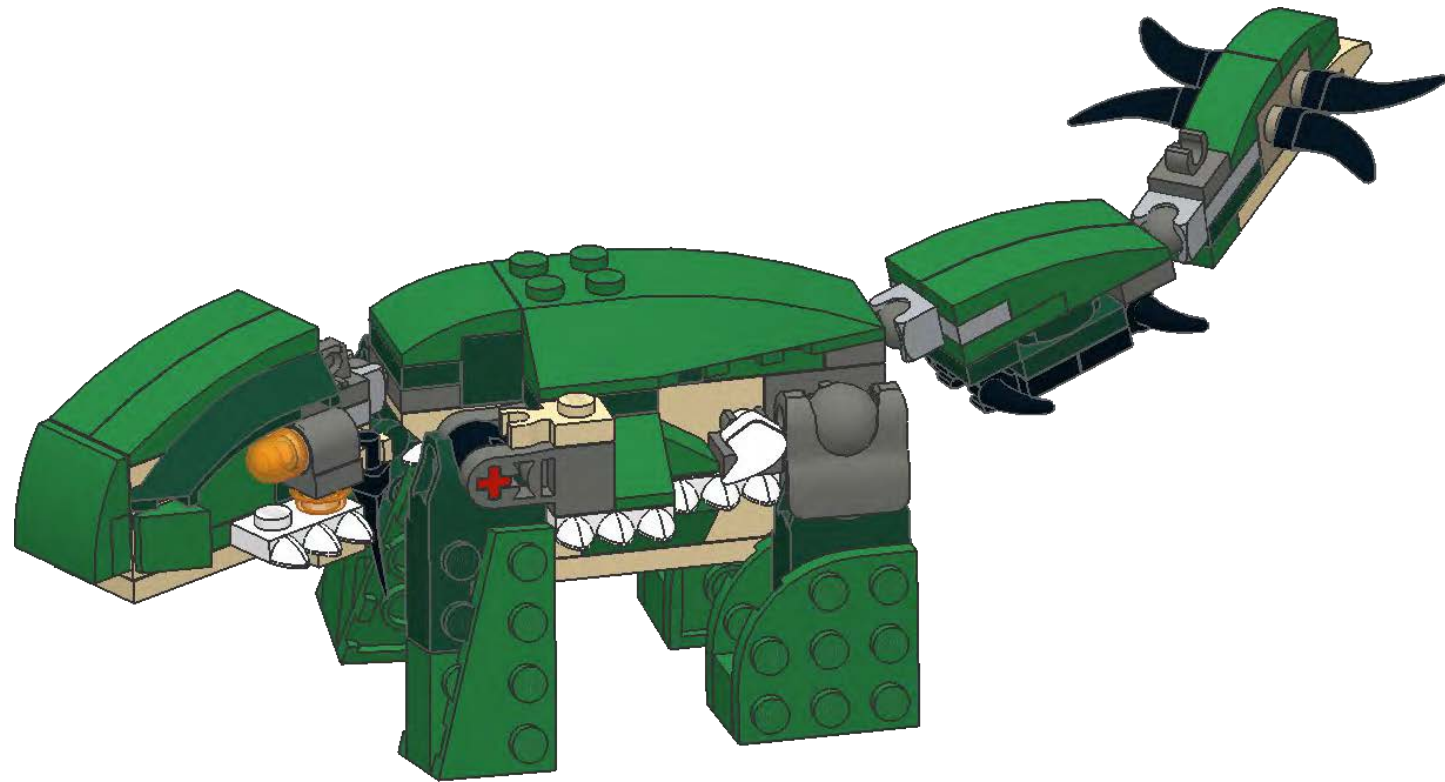

1x

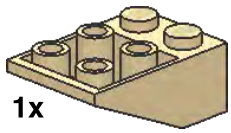

1x

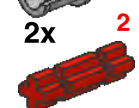
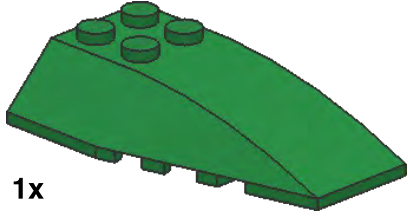

2x



2x

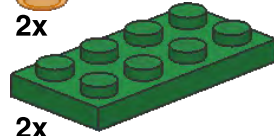

2x

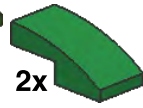
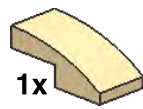

1x



4x

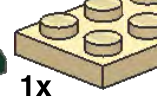
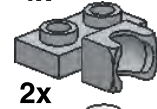

1x



1x

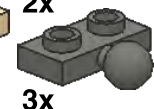
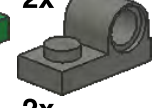
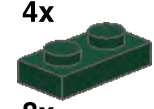
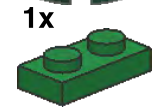
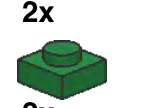
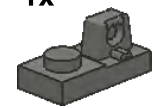
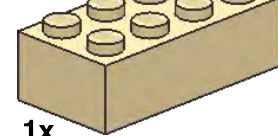

3x



2x

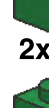

1x

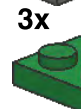
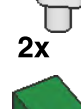

2x