

Кровать МИЛАНА / Bed MILANA

Код ТН ВЭД ЕАЭС

9403 50 000 1

отрезать
и приклеить

1634	676	2046

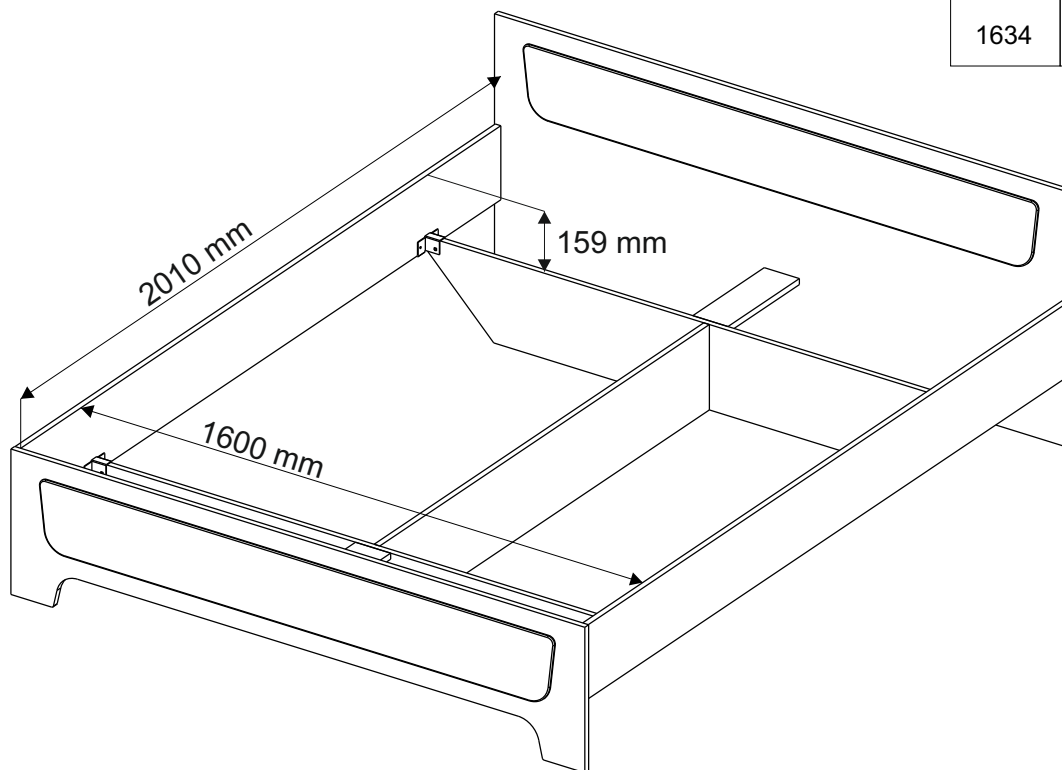

32КМК2505
32КМФ2506

Комплектовочная ведомость/Set package sheet

Упак/ Package	Наименование	Description	Цвет детали/ Décor	Размер / Size, mm	Кол-во/ Quantity	№
1	Фурнитура	Furniture/Cabinetry hardware	-	-	-	-
2	Боковина левая	Side left	White	2010x196	1	1
	Боковина правая	Side right	White	2010x196	1	2

Продается отдельно/Sold separately

1	Вязка кос	Connecting element (cut)	White	1600x226	1	3
	Вязка	Connecting element	White	1380x226	1	4
	Вязка	Connecting element	White	299x100	2	5
	Щиток кос	Headboard (cut)	White	1634x385	1	6
	Щиток	Headboard	White	1634x676	1	7

Вставка МДФ 8 мм	Insert MDF 8 mm	Pine grand	1468x188	2
------------------	-----------------	------------	----------	---

White - Белый
Pine grand - Сосна гранд

- (PL) Instrukcja montażu
 (CZ) Návod k montáži
 (D) Montageanleitung
 (GB) Assembly instruction
 (F) Model d'emploi
 (HU) Szerelési útmutató
 (I) Istruzione di montaggio
 (NL) Handleiding voor de montage

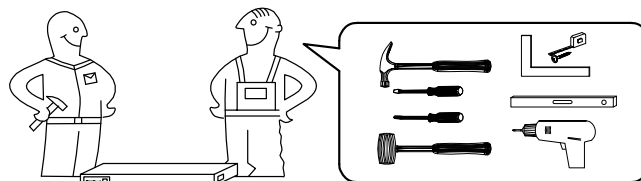





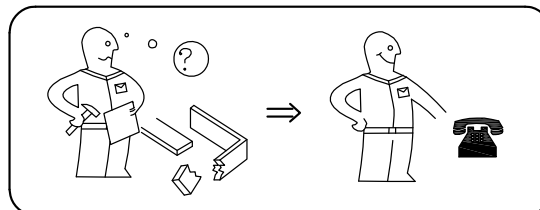
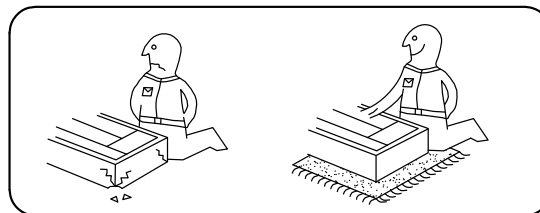

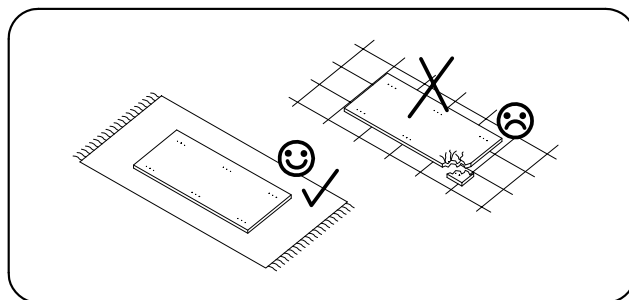
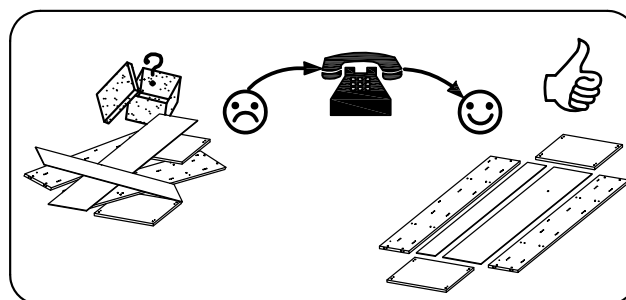
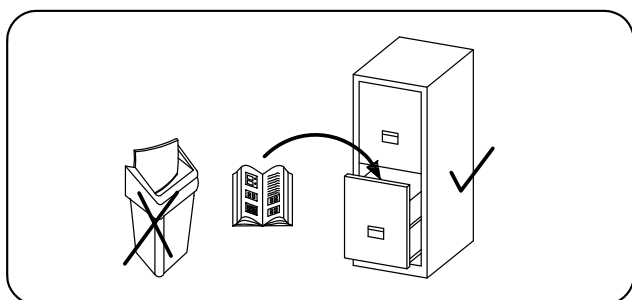

- (RU) Инструкция по монтажу
 (RO) Instrucțiuni de montare
 (SK) Návod k montáži
 (TR) Montaj talimatı

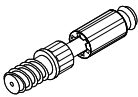
⚠ Uwaga • Upozornění • Achtung • Attention • Caution • Figyelem ⚠ Attenzione • Opgelet • Внимание • Atenție • Upozornenie • Dikkat ⚠	
PL	Czyszczenie należy wykonać wyłącznie za pomocą ściereczki lub lekko nawilżonego ręcznika. Nie stosować środków czyszczących do szorowania.
CZ	Čistění je nutné vykonávat výhradně pomocí utěrky nebo lehce navlhčeného ručníku. Nepoužívejte čističí prostředky obsahující abrazivní částice.
D	Bitte nur mit einem Staubtuch oder leicht feuchtem Lappen reinigen. Keine scheuernden Putzmittel verwenden.
GB	Please only clean with a duster or a damp cloth. Do not use any abrasive cleaners.
F	Le nettoyage se fait uniquement à l'aide d'un torchon ou d'une serviette légèrement mouillée.
HU	A tisztítás kizárólag törölrőruha vagy enyhén nedvesített törölköző segítségével végezhető. Súroló hatású tisztítószereket nem szabad használni.
I	Pulire esclusivamente con un panno o un asciugamano umido.
NL	Reinig alleen met een stofdoek of een lichtjes vochtige doek. Gebruik geen schurende poetsmiddelen.
RU	Очищайте от пыли тряпкой или слегка влажной ветошью. Не допускается применение чистящих средств, не пред-назначенных для ухода за мебелью.
RO	Curățarea trebuie efectuată numai cu o cârpă sau cu un prosop ușor umezit. Nu utilizați agenți de curățare abrazivi.
SK	Čistení je nutné vykonávať výhradne pomocí utierky alebo ľahko zvlhnutým ručníkom. Nepoužívajte čistiaci prostriedky obsahujúci abrazívni častice.
TR	Lütfen sadece bir toz bezilye veya hafif nemli yumuşak bir bezle siliniz. Aşındırıcı temizlik malzemeleri kullanmayınız.

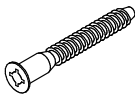

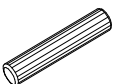
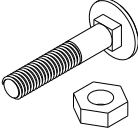
**Karta serwisowa • Servisní list • Service Karte • Service card • Carte de service • Szervizkártya
 Scheda di servizio • Service kaart • Сервисная карта • Fisa service • Servisný list • Servis karti**

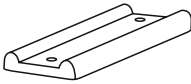
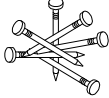
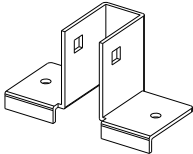

1		2		5	7x50	6	6,3x10,5	7	8x30
									
12 x		12 x		8 x		8 x		2 x	
86		15		76		48	2x20	85	
									
4 x		1 x		12 x		24 x		4 x	
72	White	73	White						
									
4 x		12 x							

