

A

ZLATA

REG1W1D

A	B	C	D	
1	S383 00010	606	555	1/2
2	S383 00011	1284	555	1/2
3	S383 11007	1904	385	1/2
4	S383 11008	1904	385	1/2
5	S383 22007	560	403	2/2
6	S383 22008	560	403	2/2
7	S383 33002	527	380	2/2
8	S383 33008	526	380	2/2
9	S383 55002	525	350	2/2
10	S383 99534	1931	553	1/2

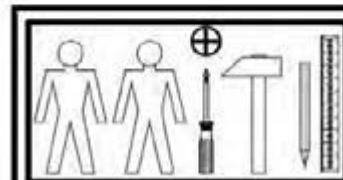
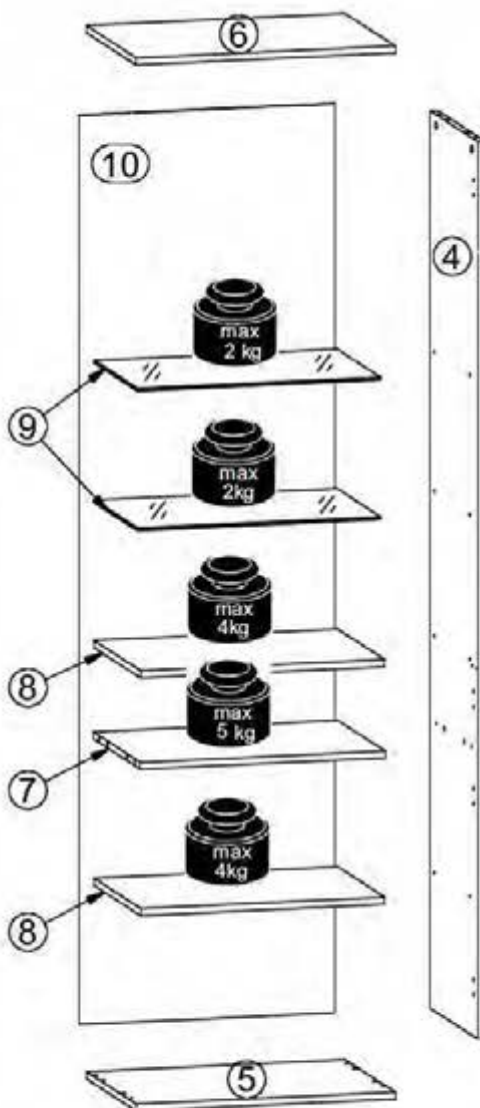
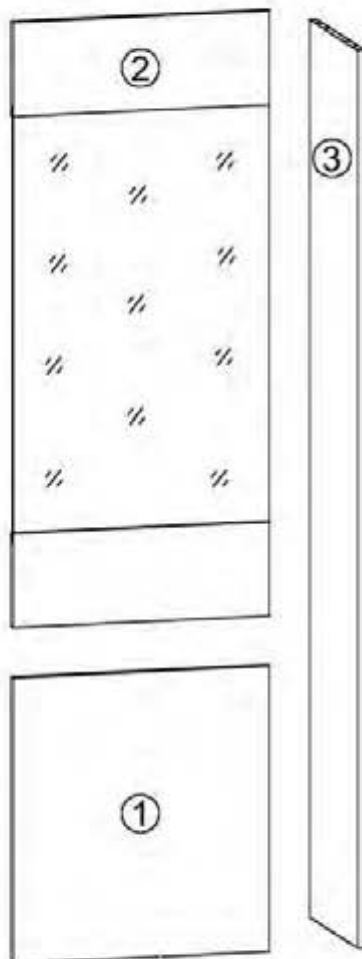
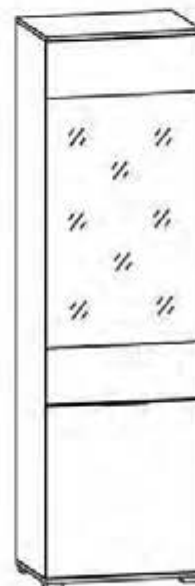

4x a44	4x b19	1x c409	8x d1	8x d3	4x e1	8x e3	12x f1	4x k8211
60x l1	4x o21	8x p51	2x p93	8x r1	8x r42	1x z2811	1x z2812	4x k8212
1x z2813	4x s2	1x z1	3x z2814					
						1x n2611	1x p38	

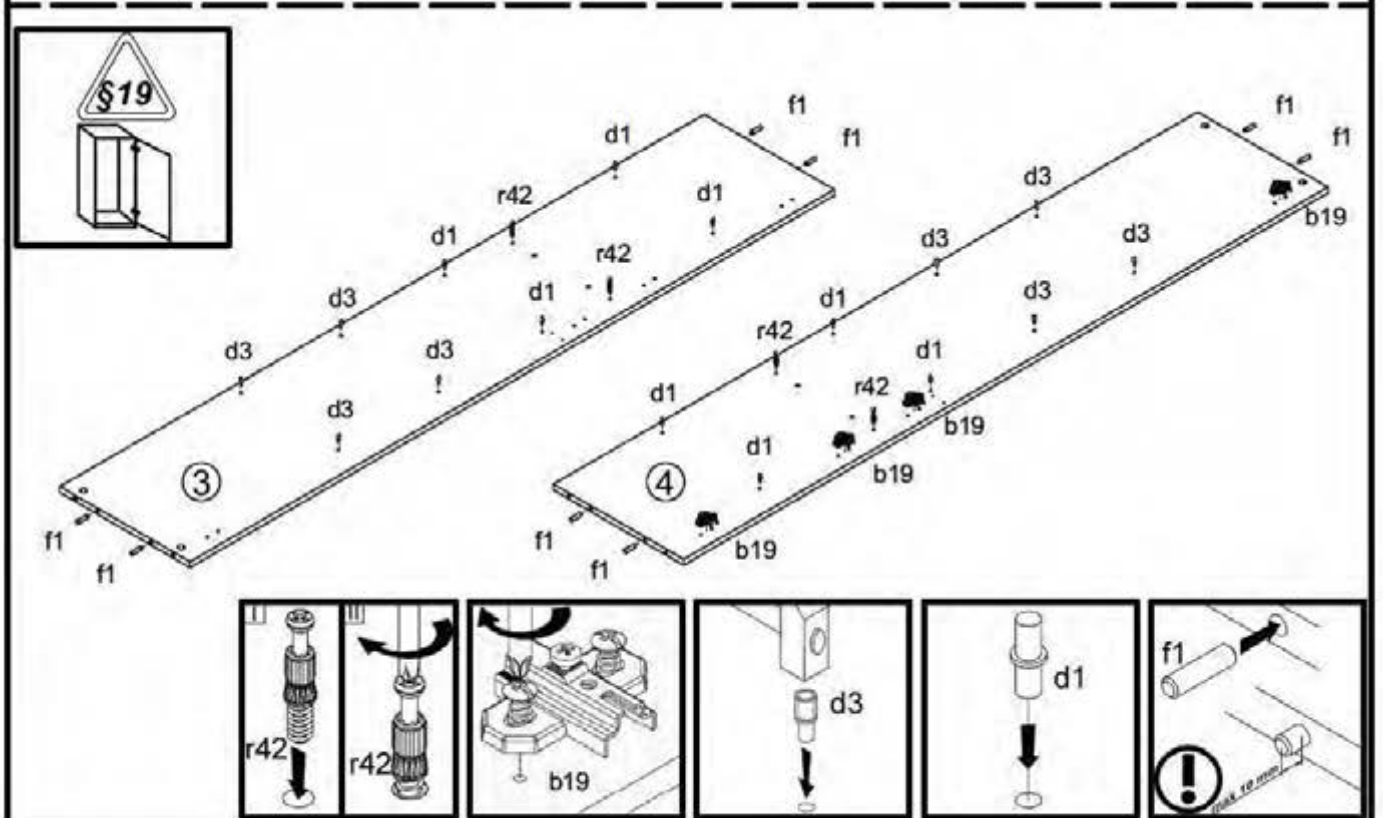
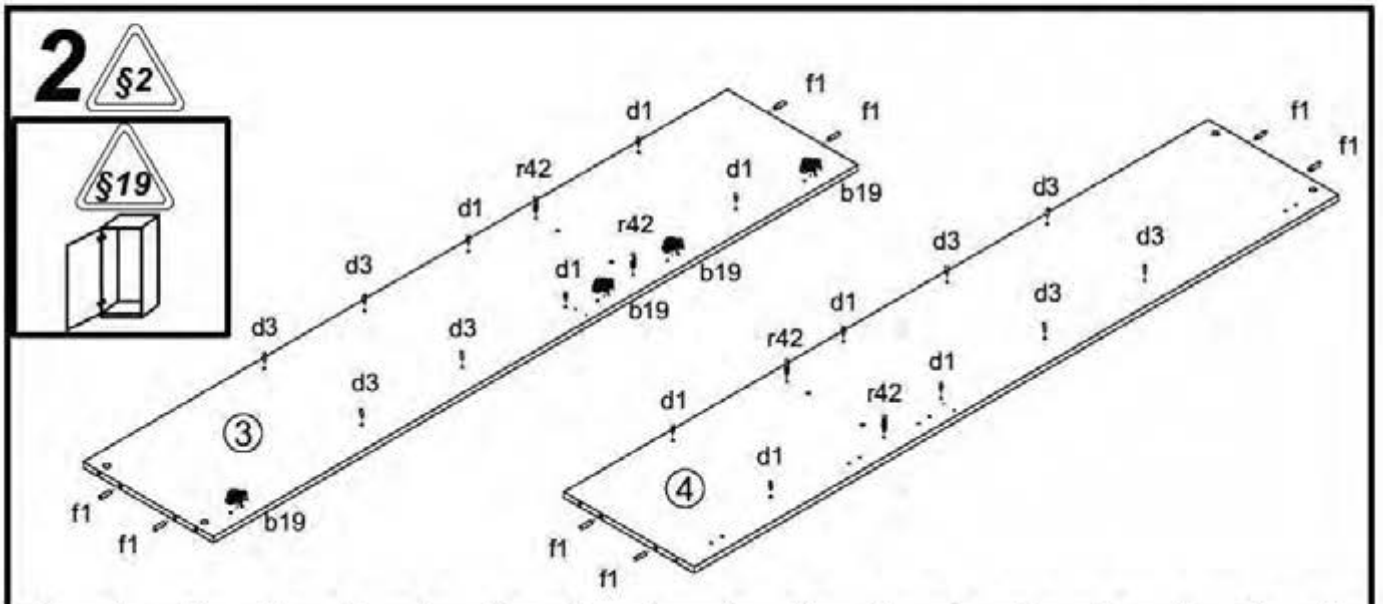
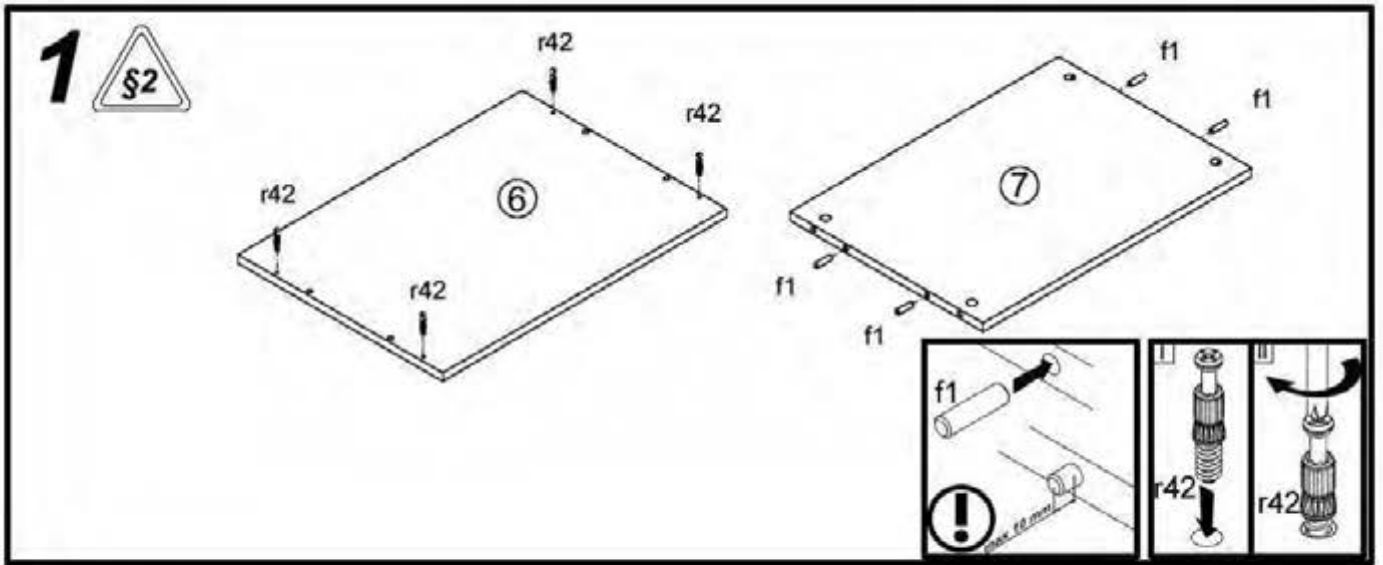

3 §6

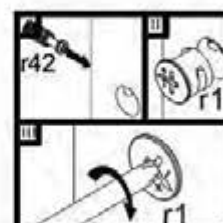
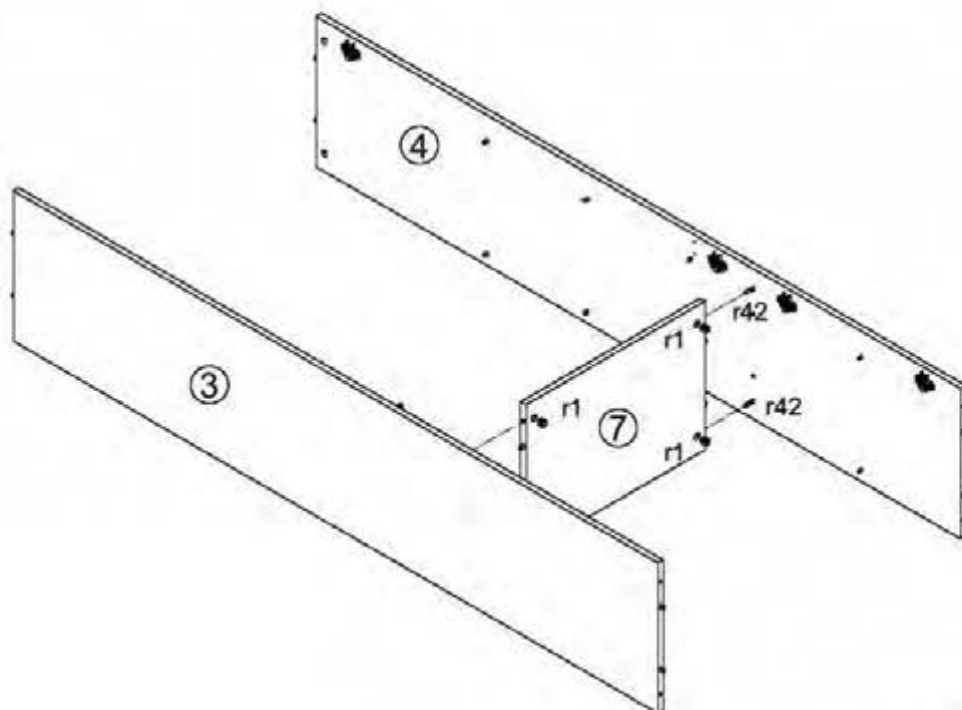
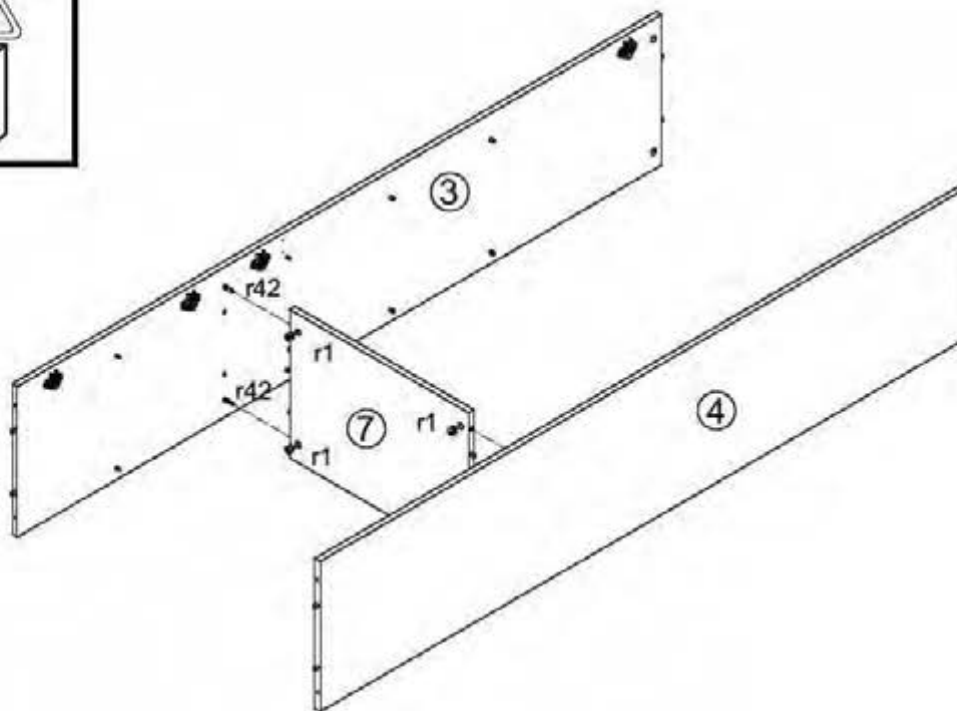

4

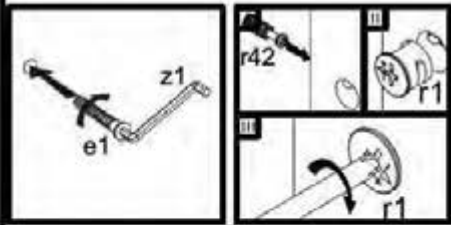
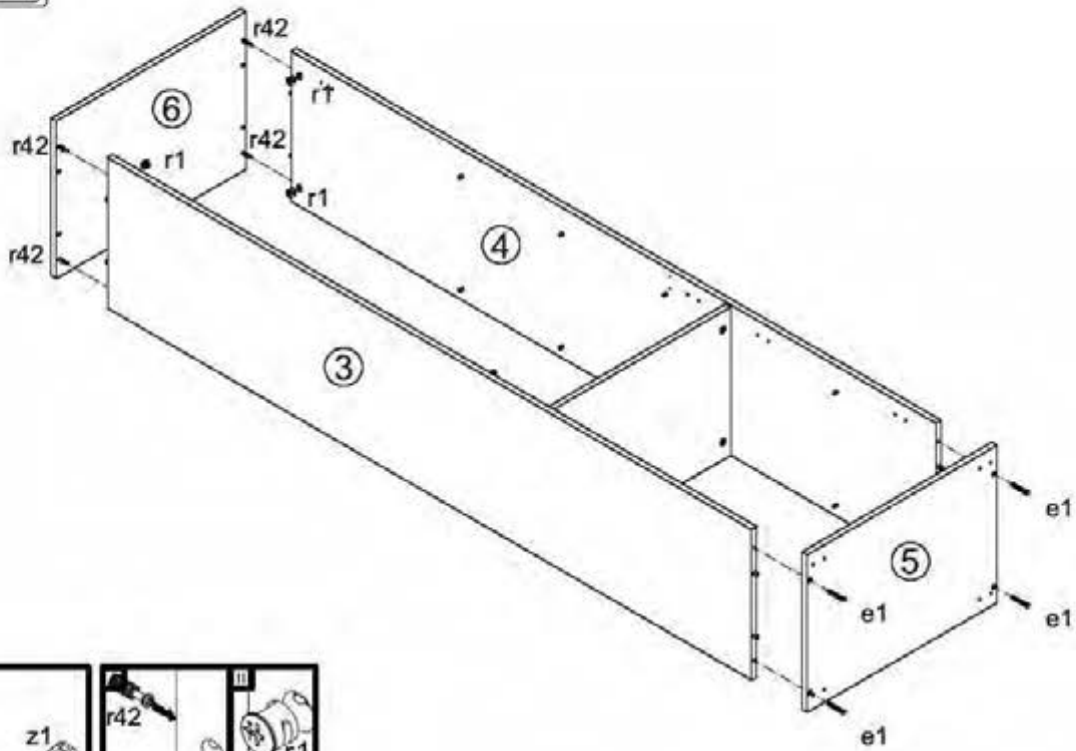

5

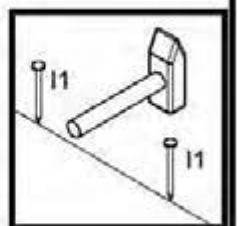
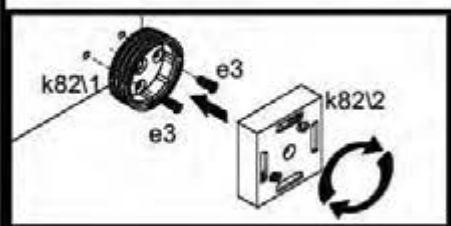
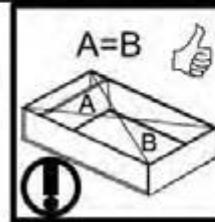
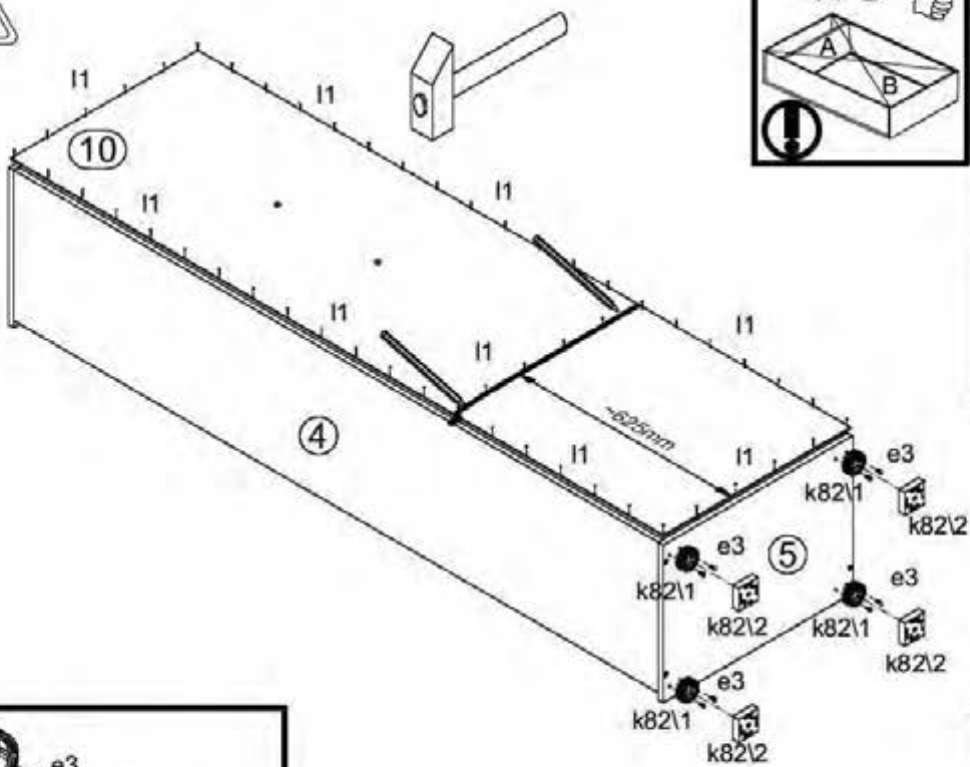

6

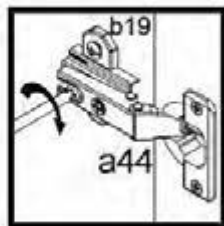
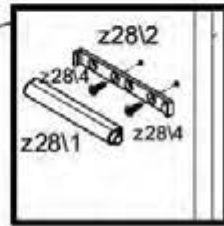
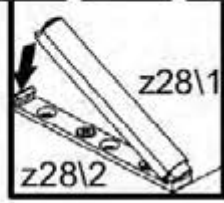
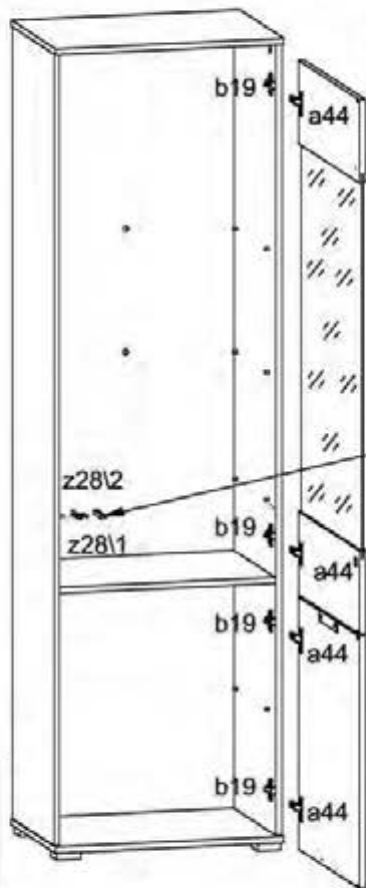
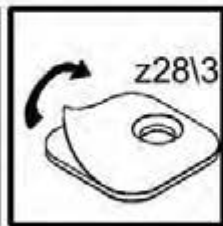
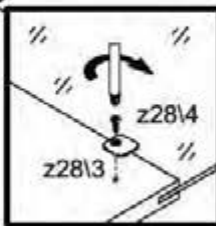
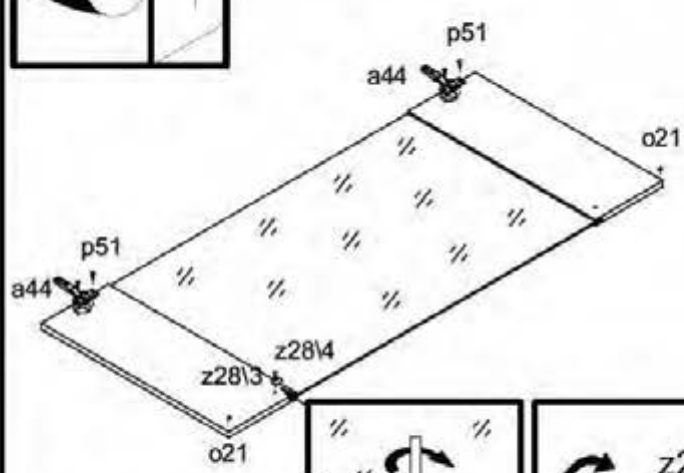
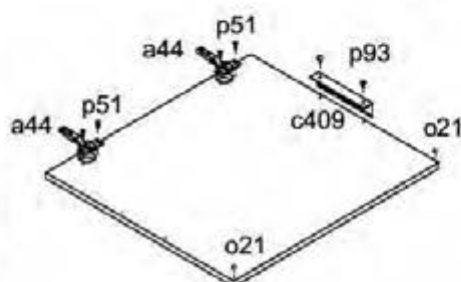
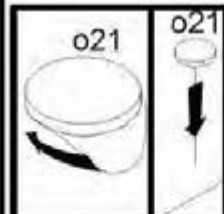
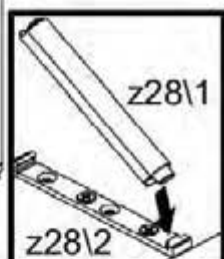
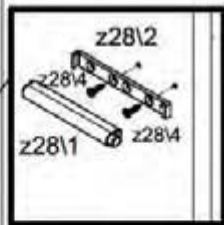
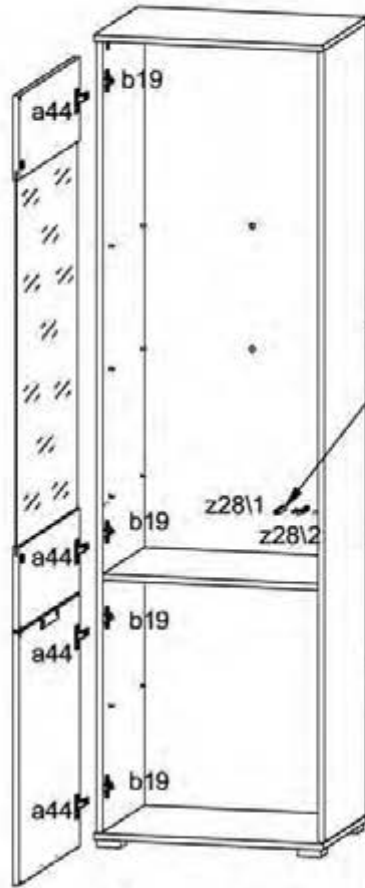
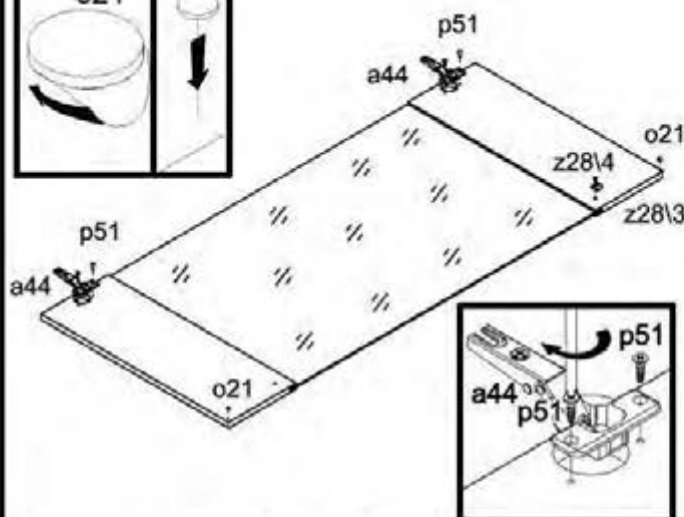
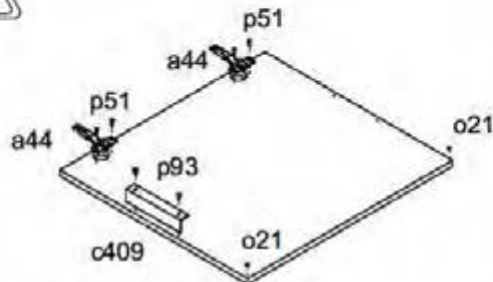
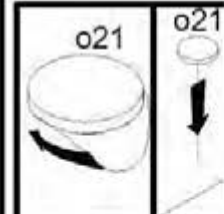

7

