

TG 500

WIRELESS MICROPHONE SYSTEM

MANUAL

beyerdynamic

1.	Safety information	Page 3
1.1	TG 500 receiver system	Page 3
1.2	TG 500 handheld and beltpack transmitter system	Page 4
1.3	NiMH rechargeable batteries, alkaline batteries	Page 4
1.4	Disposal	Page 4
2.	TG 500SR and TG 500DR diversity receiver	Page 5
2.1	Positioning the receiver	Page 5
2.2	Operation and controls	Page 5
2.3	Connecting antennas	Page 7
2.4	Connecting and setting up remote antennas	Page 9
2.5	Connecting the receiver to a microphone input	Page 9
2.6	Connecting/disconnecting the receiver to/from the mains	Page 10
2.7	Initial operation	Page 10
	2.7.1 Switching the receiver on/off	Page 10
2.8	Menu settings	Page 11
3.	TG 500H handheld transmitter	Page 19
3.1	Operation and controls	Page 19
3.2	Inserting the batteries	Page 19
3.3	Initial operation of the handheld transmitter	Page 20
3.4	Using the sensitivity switch	Page 21
3.5	Care instructions	Page 22
4.	TG 500B beltpack transmitter	Page 23
4.1	Operation and controls	Page 23
4.2	Inserting the batteries	Page 24
4.3	Initial operation of the beltpack transmitter	Page 24
4.4	Using the sensitivity switch	Page 25
4.5	Fastening the belt clip	Page 25
5.	Synchronisation	Page 26
6.	Instructions for all transmitters	Page 26
7.	Components	Page 27
8.	Sets	Page 27
9.	Optional accessories	Page 28
10.	Technical specifications	Page 29
11.	Service	Page 30
12.	Authorisation and registration obligation	Page 30
13.	Simplified EU declaration of conformity	Page 30

Thank you for putting your trust in us and choosing to buy the beyerdynamic TG 500 wireless system. Before using it for the first time, please take a moment to carefully read this user manual.

The system is extremely flexible and is suitable for professional audio applications on a stage, on tour or for installations. It has an operating range of up to 120m with the supplied antennas, and its large dynamic range allows for an excellent signal-to-noise ratio.

The system is supplemented by ergonomic handheld and backpack transmitters. Sophisticated battery compartment solutions allow for rapid battery replacement.

1. Safety information

General

- Please READ this user manual.
- Please KEEP this user manual.
- Please FOLLOW the specified operating and safety instructions.

Disclaimer

- Beyerdynamic GmbH & Co. KG will not be liable for any damage to the product or injury to persons caused by negligent, improper, incorrect or inappropriate operation of the product.

1.1 TG 500 receiver system



The lightning symbol in an isosceles triangle alerts the user to an uninsulated and potentially hazardous contact voltage within the device that may be strong enough to give users an electric shock.



An exclamation mark in an isosceles triangle alerts the user to important instructions for operating and maintaining the product in the accompanying documentation.

1. Please read these instructions.
2. Please keep these instructions.
3. Please observe all warnings.
4. Follow all instructions.
5. Do not use this device near water.
6. Only clean the device with a dry cloth.
7. Do not mount the device near sources of heat such as radiators, heat accumulators, ovens or other appliances (including power amplifiers) that give off heat.
8. Do not make any changes to this device's power plug.
9. Protect the connector cable from pinching or kinking, especially at the appliance itself and at the power plug.
10. Only use accessories for this device that are specified by the manufacturer.
11. Disconnect the device from the mains during thunderstorms or if you do not intend to use it for long periods of time.
12. All maintenance work must be carried out by service personnel that are qualified to do so. Maintenance is required if the device itself or its power cable has been damaged, if liquids or objects have fallen into the device, if the device has been exposed to rain or heavy moisture, if the device is not operating properly, or if it has been dropped

Location

- The device must be set up in such a way that the power adaptor and all connections on the rear of the device are easily accessible.
- When transporting the device to a different location, make sure it is adequately secured and that nobody can be injured in the event of falls or impacts.

Fire safety

- Never place open fire sources (e.g. candles) on the device.

Moisture / heat sources

- Never expose the device to rain or high humidity. Do not install it in the immediate vicinity of swimming pools, shower facilities, damp basements or other areas with unusually high air humidity.
- Never place objects filled with water (e.g. vases or drinking glasses) on the device. Liquids in the devices may cause a short circuit.
- Never install or operate the device in the immediate vicinity of radiators, lighting systems or other heat-generating devices.

TG 500SR connection

- Lay all connector cables so that people cannot trip over them and injure themselves.
- Always remove the power adaptor from the power supply when undertaking any work on the inputs and outputs.
- The input voltage is 100–240V AC; the power consumption of the device is approx. 3W.
- If the device has caused a defective fuse or a short circuit, disconnect it from the mains and have it checked and repaired.
- Always unplug the power adaptor from the mains and/or the device by pulling at the plug – never by pulling the cable.
- Do not use the device if the power adaptor is damaged.
- Connection of defective or unsuitable accessories could cause damage to the device. Therefore, only use power adaptors that are available from or recommended by beyerdynamic.
- To disconnect the device from the mains, pull the power adaptor out of the power socket.

TG 500DR connection

- The device must be connected to a power socket with a protective contact.
- Always lay the cable so that it cannot kink or be cut through by sharp objects.
- Lay all connector cables so that people cannot trip over them and injure themselves.
- Always turn off the power supply when undertaking any work on the inputs and outputs.
- The input voltage is 100–240V AC; the power consumption of the device is approx. 11W.
- Check whether the connection ratings correspond to the existing mains supply. Connecting the system to an incorrect power supply may cause serious damage. Incorrect voltage may damage the device or cause an electric shock.
- Please note that different mains voltages require corresponding power cables and connector plugs.

Please refer to the table below:

Voltage	Standard power plug
110 to 125V	UL817 and CSA C 22.2 No. 42.
220 to 230V	CEE 7 page VII, SR section 107-2-D1/IEC 83 page C4.
240 V	BS 1363 (1984): "Specification for 13A fused plugs and switched and un-switched socket outlets."

- If the device has caused a defective fuse or a short circuit, disconnect it from the mains and have it checked and repaired.
- Do not touch the power cable with wet hands. There must be no water or dust on the contact pins. In either case, you could suffer an electric shock.
- The power cable must be securely connected. There is a risk of fire if it is loose.
- Always unplug the power cable from the mains and/or the device by pulling at the plug – never by pulling the cable. This could damage the cable and cause an electric shock or fire.
- Do not use the device if the mains plug is damaged.

- Connection of defective or unsuitable accessories could cause damage to the device. Therefore, only use connector cables that are available from or recommended by beyerdynamic.
- To disconnect the receiver from the mains, switch it off and pull the power plug out of the power socket.

Troubleshooting/repairs

- Never open the device yourself.
- Refer all service work to authorised professionals only.

Cleaning

- Only clean the device with a dry or slightly damp cloth. Never use solvents, as these will damage the surface.

1.2 TG 500 handheld and backpack transmitter system

- Protect the transmitter from moisture, falling and impacts. You may injure yourself or others or damage the transmitter.
- Always switch the transmitter off before replacing the batteries.

Handheld transmitter

- Do not blow into the microphone. In condenser microphones, this could damage the converter. Perform a voice test instead.

Backpack transmitter

- Clip-on microphones can be very small. There is a risk of suffocation if accidentally swallowed. Therefore, keep such microphones out of the reach of children.

Battery care

- Avoid complete draining of the battery. This could damage the battery and shorten its service life.
- If battery-powered devices are not used for long periods of time (e.g. 1 year), battery self-discharge may be accelerated. For long-term storage, the temperature should be between +10°C and +30°C.
- If you do not use the transmitter for several months, the transmitter batteries should be removed and charged at least once a year to prevent leakage or deterioration in performance due to self-discharge

Charging contacts

- The charging contacts could cause property damage, injuries or fire damage if they come into contact with conductive materials such as jewellery, keys or chains. This can lead to a closed electric circuit and, therefore, to the material overheating. To avoid this kind of unintentional electric circuit, the charging contacts must be handled with care. This is especially important if the transmitter is transported in a bag or another container along with metallic objects.
- From time to time, clean the battery and charging contacts of the transmitter with a soft, lint-free cloth moistened with spirit or alcohol. Always remove the batteries from the battery compartment beforehand.

1.3 NiMH rechargeable batteries, alkaline batteries

- The handheld and backpack transmitters of the TG 500 system can only be operated with AA (LR6) Mignon alkaline batteries or structurally identical NiMH rechargeable batteries.
- Standard alkaline batteries may have length tolerances of 2–3mm. It is therefore important to ensure a good contact when replacing the batteries.
- If you do not use the transmitter for weeks or months, please remove the batteries. Batteries may leak after long periods of non-use and may corrode circuit paths and other components. This means repairs will no longer be possible. In this case, all

warranty claims will be void. Even the description “Leak proof” on batteries is not a guarantee against leaks.

- Never disassemble the batteries. The contained battery acid will damage skin and clothing.
- Misuse or improper use could cause the batteries to leak. In extreme cases, there is a risk of explosion, heat, fire, smoke or gas.
- Never expose the batteries to excessive heat such as sunshine, fire or the like.

1.4 Disposal

- Remove the batteries when disposing of the transmitter.
- Used batteries may contain harmful substances that are harmful to your health and the environment.
- Always dispose of used batteries in accordance with the applicable disposal regulations. Do not throw batteries into fire (risk of explosion) or into residual waste. Please hand in batteries at retail outlets or at communal recycling centres. Return is free of charge and stipulated by law. Please only dispose of discharged batteries in the containers provided.
- Details of how to remove batteries from the device can be found in the chapter “Inserting the batteries”.
- All batteries get recycled. This allows for valuable raw materials such as iron, zinc or nickel to be regained.
- At the end of its operating life this product may not be disposed of along with normal household waste. Please take it to a designated recycling point for electric and electronic appliances. This is indicated by the symbol on the product, the operating instructions or the packaging



2. TG 500SR and TG 500DR diversity receiver

2.1 Positioning the receiver

- Position the receiver in the room in which the transmission is taking place.
- Position the receiver as close as possible to the transmitter. For optimum reception, there should be a line of sight between the transmitter and the receiver. The minimum distance between the transmitter and receiver is 1m.
- Do not position the receiver directly next to digitally controlled devices.

2.2 Operation and controls

Figure 2-1: TG 500SR single-channel receiver – front

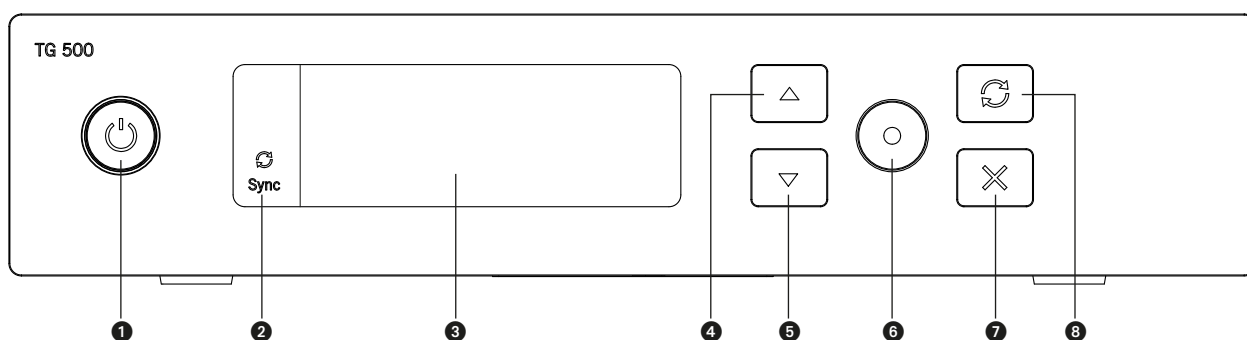
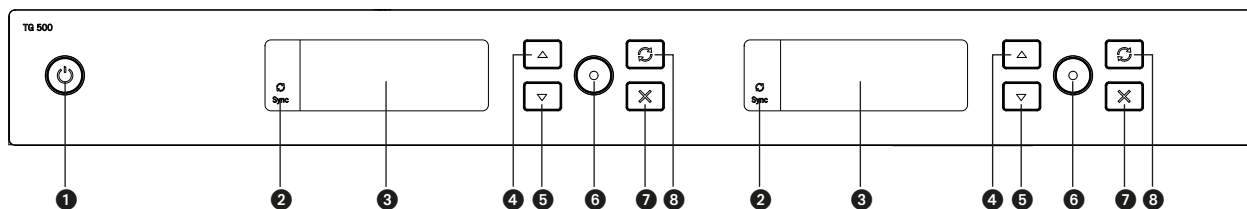

Figure 2-2: TG 500DR two-channel receiver – front



- ❶ On/off button
- ❷ Infrared interface for synchronisation of receiver and transmitter
- ❸ Backlit LCD
- ❹ Up button

- ❺ Down button
- ❻ Enter button
- ❼ Exit button
- ❽ Button for synchronisation of receiver and transmitter

Figure 2-3: TG 500SR receiver – back

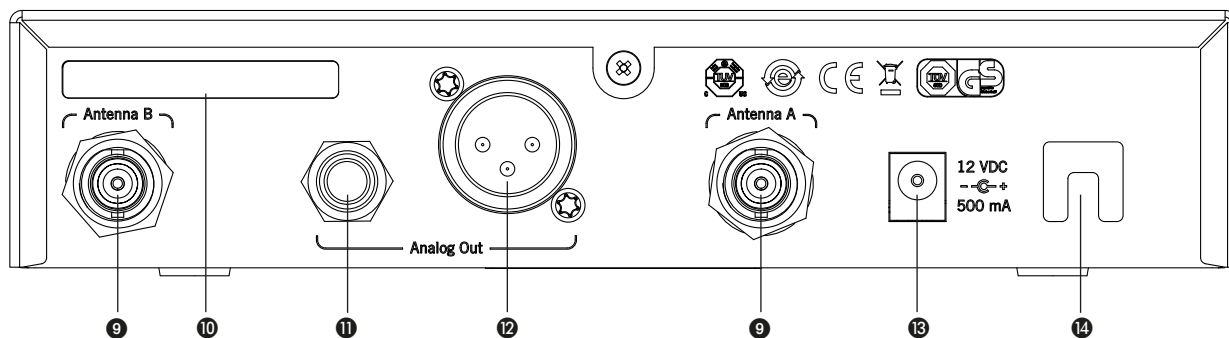
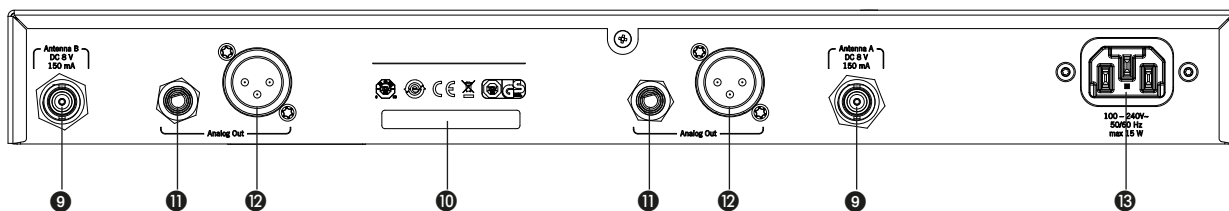
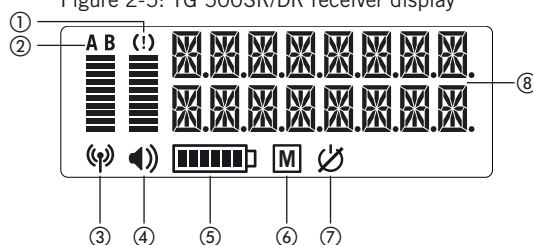

Figure 2-4: TG 500DR receiver – back



- ⑨ Antenna input A or B
- ⑩ Information about frequency band
- ⑪ Audio output, 3-pin jack
- ⑫ Audio output, 3-pin XLR
- ⑬ TG 500SR: DC connector for power adaptor, 12V DC, 500mA
500DR: Mains connection 100–240V, 50/60Hz, max. 15W
- ⑭ Strain relief for the power adaptor cable

Figure 2-5: TG 500SR/DR receiver display



- ① Overload display
- ② Active diversity channel A or B
- ③ HF level display
- ④ Audio level display
- ⑤ Transmitter battery display
- ⑥ Transmitter mute function activated
- ⑦ Transmitter lock function activated
- ⑧ Text display

2.3 Connecting antennas

- Connect the supplied antennas to the antenna inputs A and B 9 and orient them outwards in a V shape (approx. 60° angle).
Important: For diversity operation, it is essential to connect both antennas! Evaluation electronics select the antenna that provides the best signal.
- If the receiver is to be built into a 19" rack, the antennas can be attached to the front of the receiver. To do this, use the supplied Rack Mount Kit and the optionally available WA-CKF antenna front mounting kit.

Figure 2-6: Connecting antennas

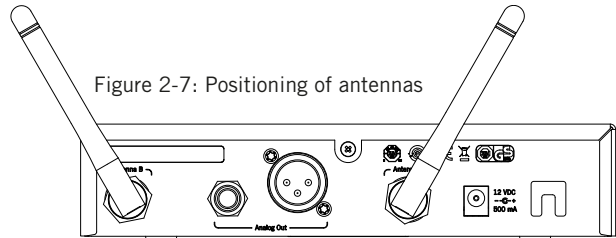
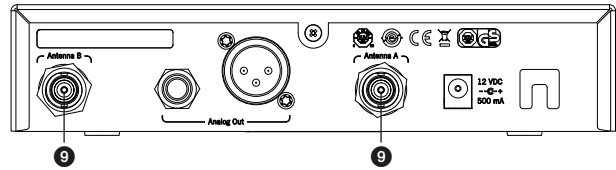

Figure 2-7: Positioning of antennas

Mounting the Rack Mount Kit on a TG 500SR receiver

- Attach the shorter mounting bracket 15 to one side of the receiver with the three supplied M4 screws.
- Attach the longer mounting bracket 16 to the other side of the receiver with the three supplied M4 screws.

Figure 2-8: Mounting the Rack Mount Kit to a receiver, top-down view

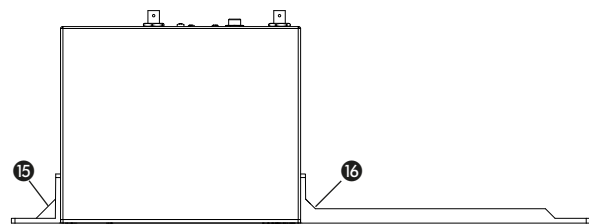
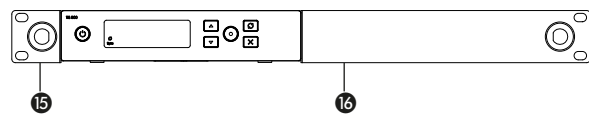

Figure 2-9: Mounting the Rack Mount Kit to a receiver, front view



Mounting the Rack Mount Kit to two TG 500SR single-channel receivers or a TG 500DR two-channel receiver

- Connect the underside of two TG 500SR receivers to a panel 17 with four supplied M4 screws.
- Attach one mounting bracket to the right and one to the left of the two connected TG 500SR single-channel receivers or one TG 500DR two-channel receiver, each with three M4 screws. 18.

Figure 2-10: Mounting the Rack Mount Kit to two receivers, bottom view

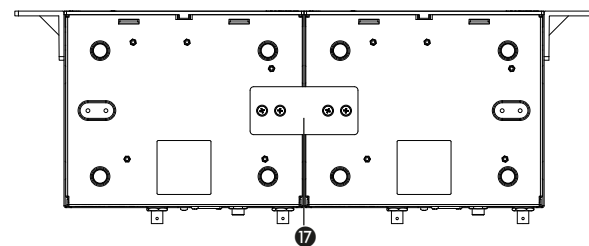
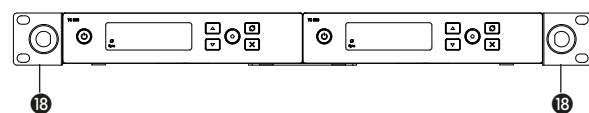

Figure 2-11: Mounting the Rack Mount Kit to two receivers, front view



- Connect the antenna cables of the antenna front mounting kit to the antenna inputs A and B ⑨.
- Loosen the nuts and washers of the enclosed adaptors.
- Push the adaptors through the respective opening, with the thread of the adaptor facing the front.
- Attach each of the adaptors with the washer and nuts.
- Push the receiver into the 19" rack and screw it to the rack with four suitable screws (not included).
- Connect each of the antenna cables to the back of the adaptor.
- Connect each of the antennas to the front (BNC sockets) of the adaptor.
- Position the antennas in a V shape facing outwards.

Caution!

- When installing the receiver in a 19" rack or together with multiple devices in a rack, the ambient temperature, the mechanical load and the electrical potential may behave differently than in individual devices.
- If you mount more than one receiver in a rack, one rack unit should always be kept free or suitable ventilation should be ensured, e.g. through ventilation panels, due to the heat build-up between the receivers.
- The ambient temperature in the rack must not exceed the temperature specified in the technical specifications.
- Make sure the rack does not become top-heavy due to too many devices so that it could fall over.
- When connecting to the mains, please note the information on the name plate. Avoid overloading the electric circuits. Provide overcurrent protection if necessary.

Figure 2-12: Antenna front mounting

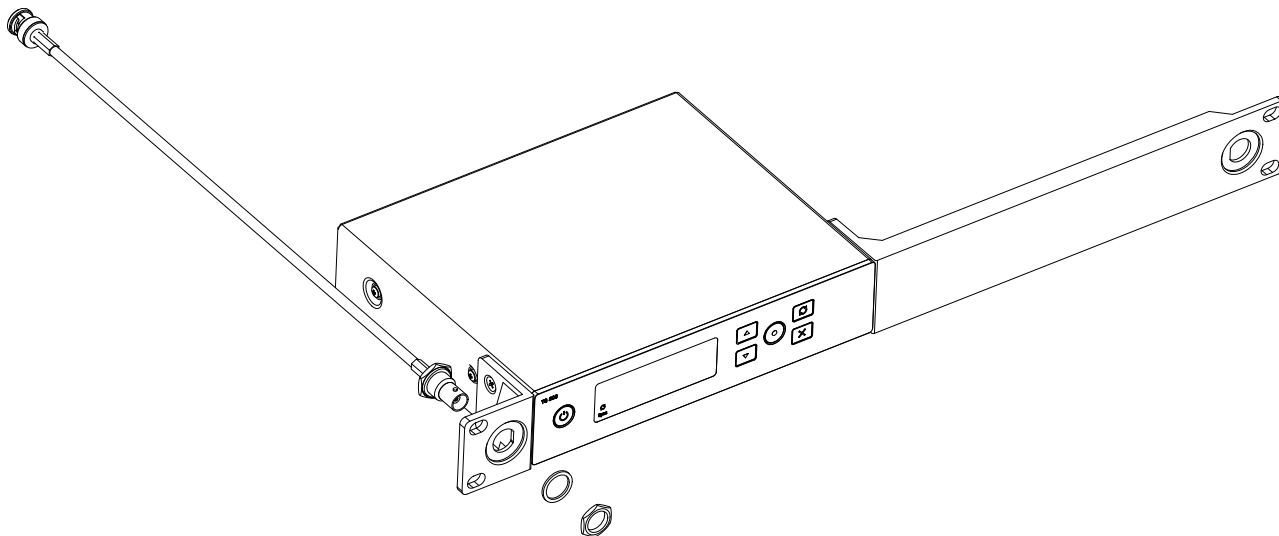
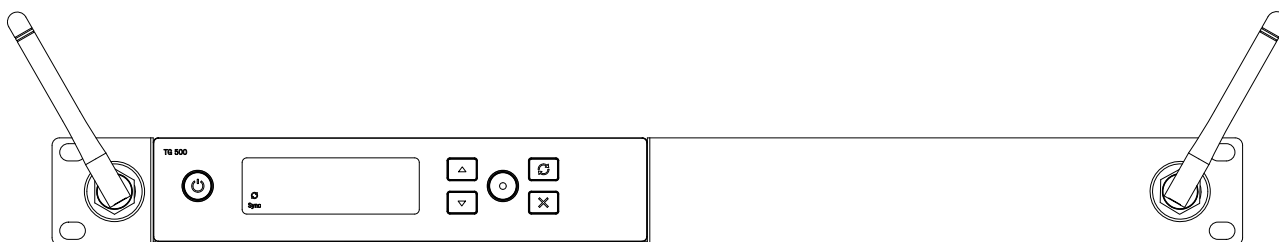

Figure 2-13: Positioning of antennas



2.4 Connecting and setting up remote antennas

If the reception in the location of the receiver is not optimal, we recommend using remote antennas.

TG 500SR

As the TG 500SR receiver does not provide a power supply, only the WA-ATO antennas (optionally available) or the WA-AMP2 antennas with additional power supply can be used. If there is more than one TG 500SR, we recommend using a splitter that provides the power supply.

TG 500DR

As the TG 500DR receiver has a short-circuit-proof voltage of 8V DC at both antenna inputs with a maximum load of 150mA available for power supply, active antennas such as the WA-ATDA (optionally available) can also be used.

If the length of the antenna cable is greater than 10m, an antenna amplifier (WA-AMP2) or an active antenna is required to compensate for the attenuation loss arising in the cable.

1. Connect the reception antennas to the antenna inputs A and B ⑨ and position the antennas to the right and left of the active area in which the transmitter is to be used. Changing the positioning of the reception antennas may improve reception.
2. A minimum distance of 1m should be maintained between the reception antennas; the maximum distance between the two reception antennas should not exceed 5m.
3. The distance between the transmitter and reception antenna should be at least 1.5m to avoid overloading and thus interference between the different channels. If this distance cannot be maintained, we recommended positioning the reception antennas raised, especially for multi-channel systems.

Important:

1. Install the reception antenna in the room where the transmission is to take place.
2. To avoid interference, do not position the reception antennas next to digitally controlled devices or attach to lighting masts (hum interference).
3. Keep a minimum distance of 50cm from metal objects, including reinforced concrete walls.
4. Do not bend antenna cables too much; keep them in arch shapes instead. Mechanically protect the antenna cable from pulling if necessary.

2.5 Connecting the receiver to a microphone input

- The receiver has balanced audio outputs.
- Connect the balanced XLR ⑫ or jack output ⑪ to the balanced microphone input on the mixing console or amplifier.
- In the menu settings of the relevant channel, adjust the level of the audio output to the input level of the amplifier or the mixing console. See chapter 2.8 “Menu settings”.

Figure 2-14: Connecting remote antennas TG 500SR

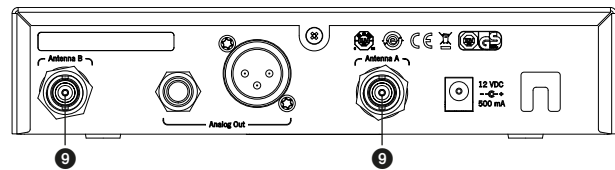

Figure 2-14a: Connecting remote antennas TG 500DR

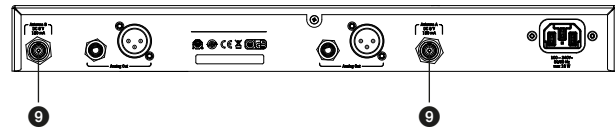
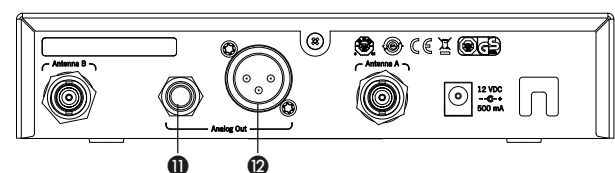

Figure 2-15: Receiver audio outputs



2.6 Connecting/disconnecting the receiver to/from the mains

- Check whether the mains voltage indicated on the receiver corresponds to the mains voltage at the operation site
Caution: Operating the device at a different mains voltage may lead to irreparable damage to the device
- **TG 500SR:**
 Connect the power adaptor to the DC connector 13 and a power socket.
- **TG 500DR:**
 Connect the power cable to the mains connection 13 and a power socket.
- To disconnect the receiver from the mains, pull **TG 500SR** the plug out of the DC connector 13 and the power adaptor out of the power socket or, on the **TG 500DR**, pull the power cable 13 out of the power socket.

Figure 2-16: TG 500SR receiver mains connection

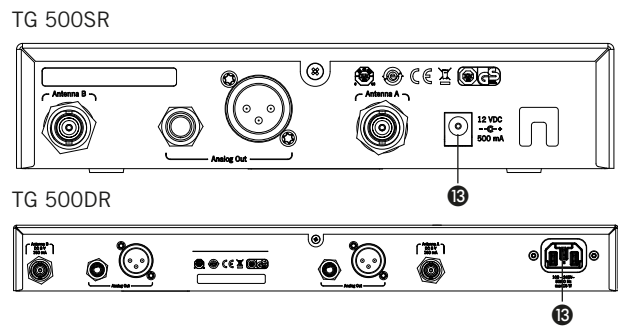

2.7 Initial operation

2.7.1 Switching the receiver on/off

- After you have mounted and connected the receiver, switch it on at the on/off button 1.

Figure 2-17: Receiver on/off

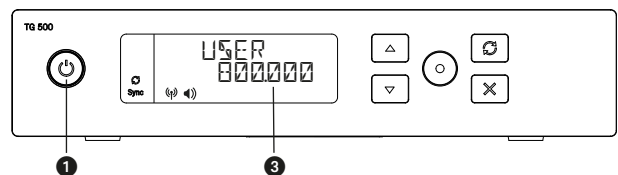

- After switching on the receiver without a transmitter switched on at the same frequency, the display 3 shows the following by default:
 The currently set name (e.g. name of the performer) 20
 The currently set frequency or group and channel 19

Figure 2-18: Display screen **without** a valid transmitter signal available

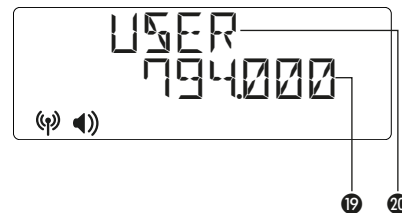

- Once you have turned on a TG 500 transmitter at the same frequency or synchronised it with the receiver, you can read off the audio 17 and HF level 16 on the display from the bar charts.
Note:
 If the HF level is displayed even though there is no transmitter switched on, there may be interference/faults caused by another transmitter at the same frequency. In this case, you should select a different frequency on the receiver and then synchronise your transmitter. You can set a suitable frequency with the scan function. See chapter 2.8 “Menu settings”, “Scan” section.
- The receiver has a receiver unit for the antennas A and B. It automatically switches to and transmits the strongest signal received. The currently active diversity channel (A or B) 15 is shown on the display.
- A battery symbol 18 displays the battery status of the switched-on transmitter. Six bars in the battery symbol indicate full batteries. If no more bars are shown, or if the battery symbol is flashing, the batteries only have an operating time of approx. 10 to 30 minutes remaining. In this case, you should replace the batteries in the transmitter as soon as possible.

Figure 2-19: Display screen with a **valid** transmitter signal available

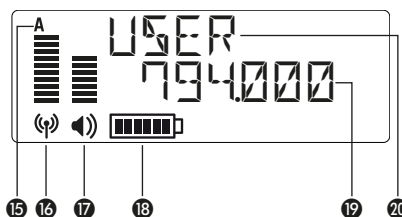

2.8 Menu settings

- You can change the settings for the name, frequency group, frequency, gain, etc. in the various menus on the receiver.
- Press the enter button **6** to open the menu.
Press the down **5** or up button **4** to scroll through the menu.
Press the enter button **3** to open the various submenus and, once the parameter starts flashing, you can change the settings using the up **4** or down buttons **5**.
Press the enter button **6** to confirm the selected setting.
- You can exit the menu or menu item at any time with the exit button **7**. **Caution:** if you exit the menu while changing a setting, it will be discarded.
- We recommend changing **all** the settings on the receiver first, and then switching on and synchronising the transmitter so that it takes over all the settings. The settings described in this chapter are changed **without** the transmitter switched on.
- **Caution:** If you do not change any settings or press the enter button **6** for a few seconds, the submenu will close automatically and the standard view will reappear on the display **3**. Settings that are **not** confirmed by pressing the enter button **6** will not be saved.

Figure 2-20: Receiver switched on / transmitter off

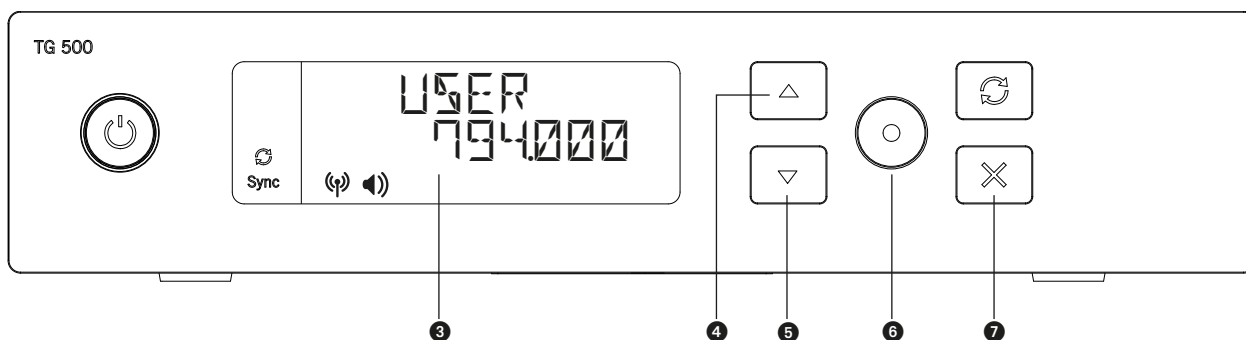
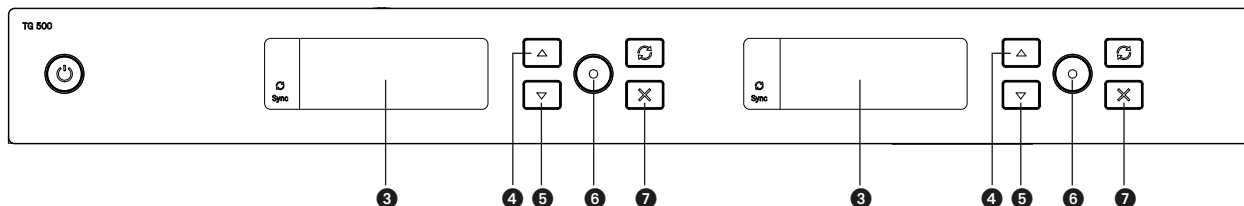

Figure 2-20a: Receiver switched on / transmitter off



- The following menu settings are possible:
- **NAME**
In the "NAME" menu, you can enter a name, e.g. the name of the performer.

Press the enter button **6** to open the submenu.

Press the up **4** or down button **5** to select the letters/characters. You can enter a maximum of seven letters/characters.
Press the enter button **6** to confirm.

Figure 2-21: Selecting the "Name" menu

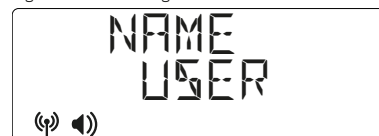
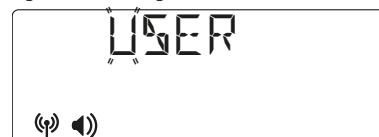

Figure 2-22: Entering a name



• **Frequency group (GR) / Channel (CH)**

In the “GR/CH” menu, you can select a predefined (intermodulation-free) frequency group and a channel from this group.

Press the enter button **6** to open the submenu.

Press the up **4** or down button **5** to select the desired group. Depending on the frequency band, you can select from up to 8 groups. In each group, the channels are arranged in irregular frequency intervals. This means that interference between the transmitters is largely avoided.

Press the enter button **6** to confirm.

Note: for multi-channel systems, the frequencies must be within one group.

Press the enter button **6** to so that you can select the desired channel from the previously selected group. Press the up **4** or down button **5** to select the channel. Press the enter button **6** to confirm.

Figure 2-23: Selecting the “Frequency group (GR) / Channel (CH)” submenu

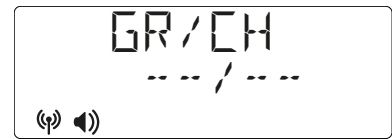

Figure 2-24: Selecting the frequency group (GR)



Figure 2-25: Selecting the channel (CH)



• **Manual frequency**

In the “FREQ MAN” menu, you can manually select any frequency from a corresponding frequency band in 25kHz increments, regardless of whether it is stored in a group.

Press the enter button **6** to open the submenu.

Press the up **4** or down button **5** to select the first three figures of the desired frequency.

Press the enter button **6** to confirm.

Press the up **4** or down button **5** to select the last three figures of the desired frequency.

Press the enter button **6** to confirm.

Figure 2-26: Selecting the “Frequency” submenu



Figure 2-27: Selecting the frequency – first three figures



Figure 2-28: Selecting the frequency – last three figures



- **SCAN**

In the “SCAN” menu, you can select a channel or a frequency from a predefined group in accordance with the particular frequency band.

Press the enter button **6** to open the submenu.

Press the up **4** or down button **5** to select the frequency group in which to search for a suitable channel.

Press the enter button **6** to confirm.

Press the up **4** or down button **5** to search for a channel from the previously selected group from which to start the search.

Press the enter button **6** to confirm.

The scan process will be performed. The display shows the message “Scanning”.

The scan process is completed once the message “Scan done OK” appears.

After completing the scan, the next free channel is automatically selected. The selected channel and the group are displayed.

Important: After each scan, you will need to resynchronise the transmitter. See also chapter 5. “Synchronisation”.

Note: if the receiver does not find any free channels in the selected group, the message “Scan all busy” will appear on the display. In this case, select another group and restart the scan process.

If no free channels are found in another group either, select the frequency manually. We recommend switching the transmitter off during a manual frequency selection and watching the HF indicator on the receiver display to see if an HF level is displayed. If an HF level is displayed even though the transmitter is switched off, this means there are interferences and you should select another frequency.

Figure 2-29: Selecting the “Scan” submenu



Figure 2-30: Selecting a group in which to search for a channel



Figure 2-31: Selecting a channel from which to start the search

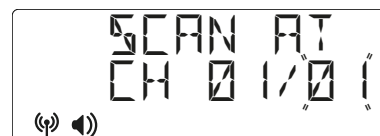

Figure 2-32: Scan process

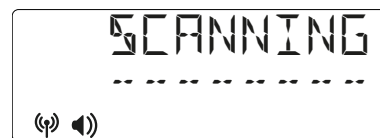

Figure 2-33: Scan process completed



Figure 2-34: Display of the selected next free channel after the search

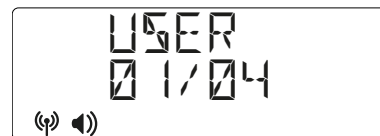

Figure 2-35: No free channels available in the selected group



- **Gain**

In the “GAIN” menu, you can adjust the receiver output level to the input level of the amplifier or mixing console. In other words, if the signal received through the transmitter is very quiet, it can be amplified using the “Gain” menu item.

Press the enter button **6** to open the submenu.

Press the up **4** or down button **5** to set the amplification in 3 dB increments between -12 dB and +6 dB.

Press the enter button **6** to confirm.

For the handheld transmitter, you can adjust the sensitivity to 0/+12 dB with the two-stage gain switch **10**:

For the backpack transmitter, you can adjust the sensitivity to 0/+12/+24 dB with the three-stage gain switch **9**:

passive instruments = 0 dB; active instruments = -12 dB
See also chapter 4.4 “Using the sensitivity switch”.

- **TX RF Power**

In the “TX RF PW” menu, you can set the transmission power. The “Standard” setting is recommended if the transmitter is located near the reception antennas or for multi-channel systems, to prevent interference from intermodulation.

The “High” setting is recommended if there are problems with the operating range or if there is a very large distance between the transmitter and the reception antennas.

Press the enter button **6** to open the submenu.

Press the up **4** or down button **5** to set the transmission to “High” or “Standard”.

Press the enter button **6** to confirm.

Important: Once you have confirmed the selected option, you will need to resynchronise the transmitter. See also chapter 5. “Synchronisation”.

- **TX Battery**

In the “TX BATT” menu, you can set whether an alkaline battery or NiMH rechargeable battery is inserted in the transmitter so that the battery or charge status is shown correctly on the display.

Press the enter button **6** to open the submenu.

Press the up **4** or down button **5** to select “Alkaline” or “NiMH” for the battery inserted in the transmitter.

Press the enter button **6** to confirm.

Important: Once you have confirmed the selected option, you will need to resynchronise the transmitter. See also chapter 5. “Synchronisation”.

Figure 2-36: Selecting the “Gain” submenu



Figure 2-37: Setting the amplification for the signal received through the transmitter

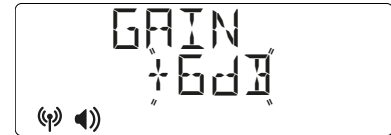

Figure 2-38: Select the “TX RF PW” submenu



Figure 2-39: Select the transmission power

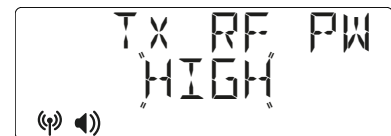
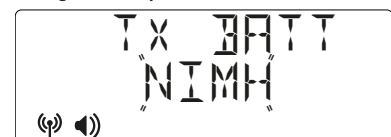



Figure 2-40: Selecting the “TX battery” submenu



Figure 2-41: Selecting alkaline battery or NiMH rechargeable battery



• TX Lock

In the “TX LOCK” menu, you can set whether the transmitter can be switched off at its on/off switch or if it is protected from switching off by mistake. The lock symbol will appear on the standard display: 

To switch off the transmitter when the “Tx Lock” function is activated, the following steps must be taken:

- Hold the on/off button until the message “Tx PWLOCK” appears on the transmitter display.
- Release the on/off button briefly.
- Press the on/off button again until the message “Off” appears on the transmitter display.

Press the enter button **6** to open the submenu.

Press the up **4** or down button **5** to switch the Tx Lock function on or off.

Press the enter button **6** to confirm. The lock symbol will be shown on the display.

Important: once you have confirmed the selected option, you will need to resynchronise the transmitter. See also chapter 5. “Synchronisation”.

• TX Mute Mode

In the “TX MUTE” menu, you can set whether the mute button on the transmitter is active or not.

If the “Tx Mute” function is activated (ON), the transmitter can be muted using the on/off button (beltpack transmitter) or the mute button (handheld transmitter).

If the “Tx Mute” function is activated, the mute symbol will appear on the standard display: 

If the “Tx Mute” function is to be deactivated so that the transmitter is not muted using the on/off button or mute button, select “Off”.

Press the enter button **6** to open the submenu.

Press the up **4** or down button **5** to switch the Tx Mute function on or off.

Press the enter button **6** to confirm. The mute symbol will be shown on the display.

Important: once you have confirmed the selected option, you will need to resynchronise the transmitter. See also chapter 5. “Synchronisation”.

If the microphone on the transmitter is muted, this is also indicated on the receiver display by the “TX Mute” indicator and the name entered on the receiver alternating on the receiver display.

Figure 2-42: Selecting the “TX Lock” submenu

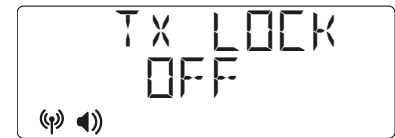

Figure 2-43: Switching on the lock function



Figure 2-44: Lock function activated



Figure 2-45: Selecting the “TX Mute” submenu

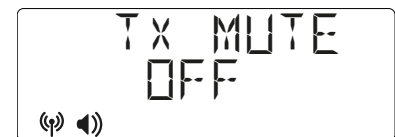

Figure 2-46: Switching on the mute function



Figure 2-47: Mute function activated

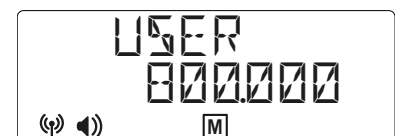
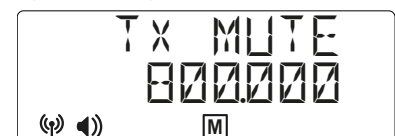

Figure 2-48: Microphone muted



- **Audiomix – ONLY ON TG 500DR!**

If you wish to emit both audio signals (e.g. vocals and guitar), mixed across both outputs, set the “Audiomix” function to “ON”.

In the “Gain” menu, you can adjust the volume for each channel accordingly until you achieve the desired mix.

To use both channels independently of each other, set the “Audiomix” function to “OFF”.

Press the enter button **6** to open the submenu.

Press the up **4** or down button **5** to activate (ON) or deactivate (OFF) the “Audiomix” function. Press the enter button **6** to confirm.

Figure 2-49: Selecting the “Audiomix” submenu



Figure 2-50: Activating/deactivating the Audiomix



- **Squelch**

In the “SQUELCH” menu you can manually select the value for the so-called squelch. The squelch is used to specify the RF level from which the receiver is muted. This ensures that noises are emitted as long as the transmitter is switched off or when the transmitter is moved out of the receiving area. The default setting is -94 dBm.

Please note the following:

If you set a higher value (up to -80 dBm), it can prevent loud noise during use in environments with severe interference. However, this reduces the range.

If you set a lower value (up to -100 dBm), the range is increased, but there may be noise due to interference in the limit range.

Press the enter button **6** to open the submenu.

Press the up **4** or down button **5** to select the threshold for the squelch between -80 und -110 dBm.

Press the enter button **6** to confirm.

Figure 2-51: Selecting the “Squelch” submenu

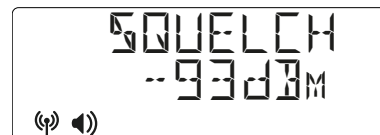

Figure 2-52: Setting the squelch



- **Restoring factory settings**

In the “Factory reset” menu, you can reset the receiver to the factory settings.

Press the enter button **6** to open the submenu.
Press the up **4** or down button **5**, to select whether you want to restore the factory settings (“Yes”) or not (“No”).

Press the enter button **6** to confirm.

Once you have decided to restore the factory settings, i.e. selected “Yes” and confirmed, the device will go through a restore operation.

Restoring the factory settings is indicated by the message “Reset”.

Once the restore operation has completed, the message “Done” will appear.
The receiver then restarts automatically and the factory settings will be restored.

Figure 2-53: Selecting the “Factory reset” submenu



Figure 2-54: Restore factory settings: no



Figure 2-55: Restore factory settings: yes



Figure 2-56: Settings are being restored to factory settings

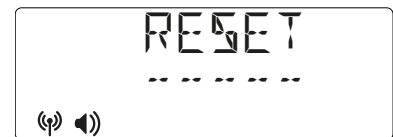

Figure 2-57: Restore operation completed



- **Display system info**

In the “System info” menu, you can display information about the receiver and the system.

Press the enter button **6** to open the submenu.
By repeatedly pressing the up **4** or down button **5**, you can scroll through the submenu and display the information listed below.

Display receiver/system hardware version

Display receiver/system hardware type

Display region band (for frequency ranges see chapter 10 “Technical specifications”)

Display current software or firmware version

To exit the “System info” submenu, press the “Exit” button **7**.

Figure 2-58: Selecting the “System info” submenu



Figure 2-59: Displaying hardware version



Figure 2-60: Displaying hardware type



Figure 2-61: Displaying region and band



Figure 2-62: Displaying software or firmware version



3. TG 500H handheld transmitter

3.1 Operation and controls

Figure 3-1: Transmitter base

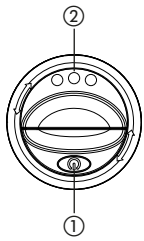

Figure 3-2: Front view

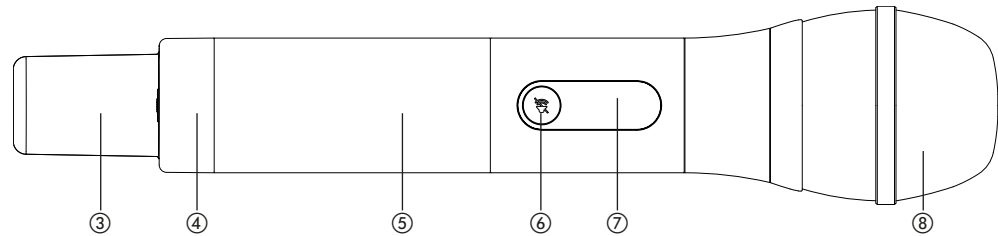
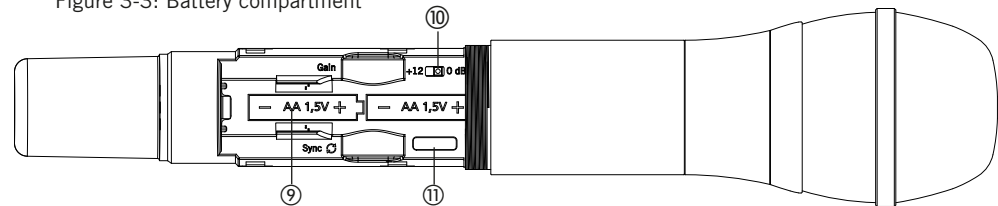

Figure 3-3: Battery compartment



- ① On/off button, lit
- ② Charging contacts
- ③ Antenna
- ④ Colour ring, interchangeable
- ⑤ Battery compartment cover
- ⑥ Programmable mute button

- ⑦ LCD
- ⑧ Microphone head (fixed)
- ⑨ Battery compartment
- ⑩ Two-stage sensitivity switch (gain) 0 dB and 12 dB
- ⑪ Infrared interface for synchronisation

Figure 3-4: TG 500H transmitter display

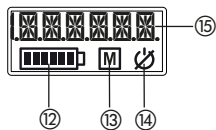

- ⑫ Battery indicator
- ⑬ Mute function activated
- ⑭ Lock function activated
- ⑮ Text display

3.2 Inserting the batteries

- Unscrew the battery compartment cover ⑤ in the direction indicated by the arrow..
- Remove the battery compartment cover ⑤.

Figure 3-5: Unscrewing the battery compartment

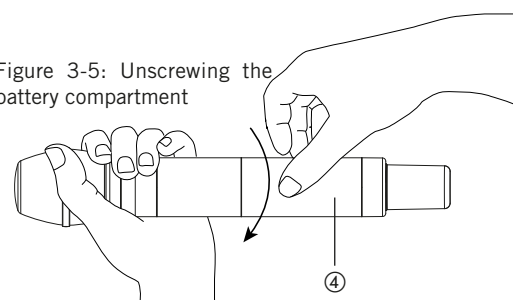

- Insert two alkaline AA 1.5V batteries or NiMH rechargeable batteries in the battery compartment ⑨ according to the symbols.
- Push the battery compartment cover back up and tighten it.

Figure 3-6: Inserting the batteries

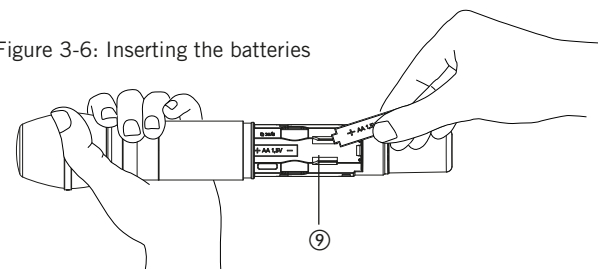

- The current battery status is shown on the display on the transmitter ⑦ and the receiver ③. Please ensure the correct battery type is selected in the channel menu on the receiver and that synchronisation is carried out.
- Flat batteries are indicated by an empty, flashing battery symbol on the transmitter and receiver display. The on/off button ① on the transmitter base also lights up red. In this case, you should replace the batteries with new ones as soon as possible.
- If you are using NiMH rechargeable batteries for operation, you can charge these with the optionally available WA-CD battery charger. The batteries can remain in the transmitter during the charging process. Further information can be found in the separate “WA-CD” user manual.
- **Important:** from time to time, clean the battery and charging contacts of the transmitter with a soft, lint-free cloth moistened with spirit or alcohol. Always remove the batteries from the battery compartment beforehand.

3.3 Initial operation of the handheld transmitter

- Switch the handheld transmitter on by pressing and holding the on/off button ① until the standard display appears on the transmitter display ⑦. The on/off button ① lights up green.

Figure 3-7: Handheld transmitter

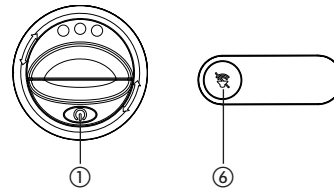

- The transmitter display ⑦ shows the battery status as well as the name entered on the receiver.

Figure 3-8: Transmitter display – Standard display



- You can access further display functions such as frequency and transmission power by repeatedly pressing the on/off button ① or the mute button ⑥ if the mute function on the receiver is **not** activated.
- Ensure the transmitter and receiver are working at the same frequency.

Figure 3-9: Displaying frequency



Figure 3-10: Displaying transmission power



- If you hold down the on/off button ① when switching on, you can display the version, hardware type, band and firmware version.

Figure 3-11: Displaying version



Figure 3-12: Displaying hardware type



Figure 3-13: Displaying band



Figure 3-14: Displaying firmware version



- To switch off the transmitter, press and hold the on/off button ①, until the message “Off” is displayed.

Figure 3-15: Switching off transmitter



- If the “Tx lock” function is activated, the handheld transmitter can still be switched off. Press the on/off button ① until the message “PW Lock” appears on the display ⑦. Release the button and then press it again until the message “Off” is displayed. The handheld transmitter is then switched off.
- If the “Mute” function on the receiver is activated, you can mute the microphone by briefly pressing the mute button ④. The activated mute function is indicated by the “M” symbol on the display. The microphone mute function is indicated both on the receiver display (TX mute display) and on the transmitter display by the word “Mute” and the name entered on the receiver alternating on the display.
- If you wish to switch to “RF off” mode, hold down the on/off button ① on the handheld transmitter until the message “RF off” appears on the display. You can now synchronise a spare transmitter to the same channel, for example, even though the main transmitter is still active (audio continues to function while synchronising).
- Perform synchronisation for the spare transmitter.
- To leave “RF off” mode, turn the transmitter off and on again.
- The transmitter comes supplied with a black ring ④. To distinguish more clearly when using multiple transmitters, the individual transmitters can be provided with different colour rings. See chapter 9. “Accessories”. Remove the ring ④ and attach the desired colour ring so that it audibly clicks into place.

3.4 Using the sensitivity switch

- The handheld transmitter has a switchable pre-attenuation of +12 dB
- If the gain setting on the transmitter is not sufficient, the audio level can be amplified by increasing the “Gain” in the receiver, in particular for quiet signals. See also chapter 2.8 “Menu settings”, “Gain” section.

Figure 3-16:
Power lock message



Figure 3-17:
Switching off in spite of power lock



Figure 3-18:
Mute function active



Figure 3-19:
Microphone muted



Figure 3-20:
RF off mode active



Figure 3-21: Changing the colour ring on the transmitter

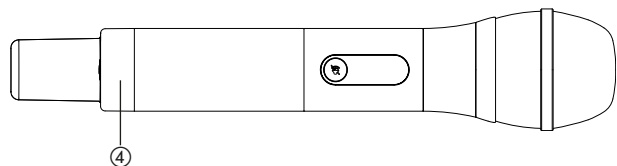
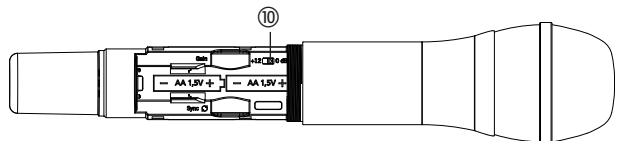

Figure 3-22: Adjusting sensitivity



3.5 Care instructions

- Protect the handheld transmitter from moisture, falling and impacts.
- Use a soft cloth moistened with spirit or alcohol to clean metallic surfaces.
- Once you start noticing sound changes, you should clean the integrated pop shield:
 - To do this, unscrew the microphone head grille anti-clockwise.
 - Remove the foam pop shield with a pair of tweezers if necessary and rinse it under clear water.
 - If required, you can also use a mild washing-up liquid.
 - Blow-dry the pop shield or leave it to dry overnight.
 - Clean the microphone head grille from the inside and outside with a slightly damp cloth or in clear water with a soft brush and leave it to dry overnight.
 - The microphone head grille is not to be cleaned in a dishwasher.
 - Place the dry pop shield back in the microphone head grille; screw the grille back in place in a clockwise direction.

Figure 3-23: Unscrewing the microphone head grille



Figure 3-24: Removing the foam pop shield



Figure 3-25: Cleaning the foam pop shield



4. TG 500B beltpack transmitter

4.1 Operation and controls

Figure 4-1: Upper side

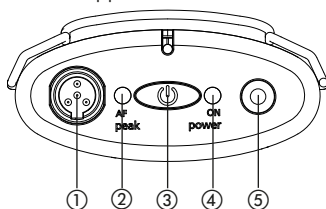

Figure 4-2: Underside

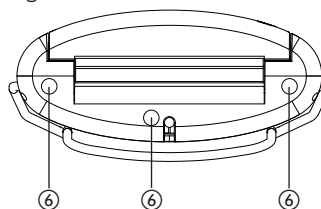

Figure 4-3:
Front view

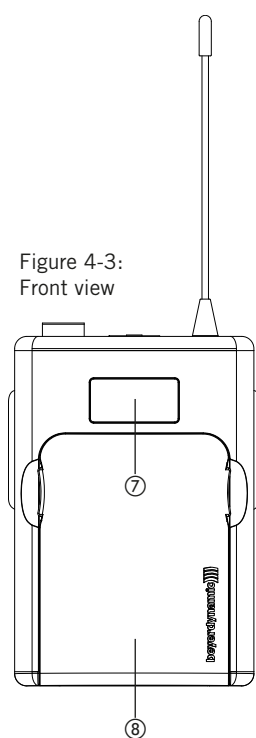

Figure 4-4:
Battery compartment

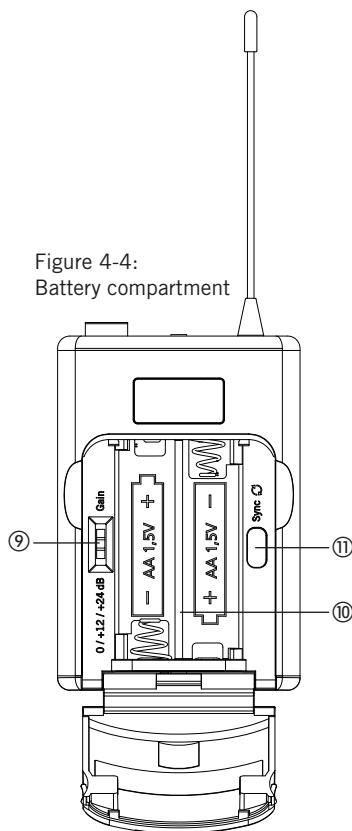
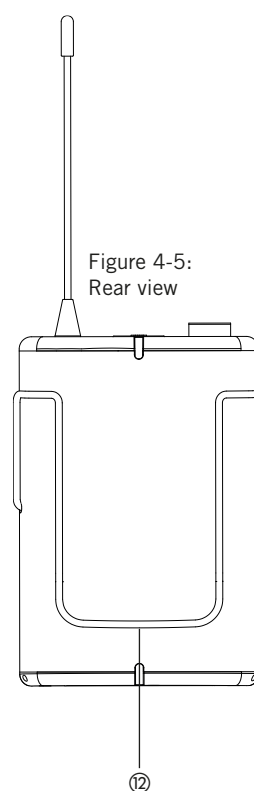

Figure 4-5:
Rear view



- ① 4-pin mini XLR connector (male) for connecting microphones or instruments
- ② LED to indicate overloading
- ③ On/off button
- ④ LED for operating display
- ⑤ Fixed antenna
- ⑥ Charging contacts

- ⑦ LCD
- ⑧ Three-stage sensitivity switch (gain) 0dB / +12dB / +24dB
- ⑨ Battery compartment cover
- ⑩ Battery compartment
- ⑪ Infrared interface for synchronisation
- ⑫ Belt clip

4.2 Inserting the batteries

- Grip the battery compartment cover ⑧ at the top right and left side indentations.
- Flip down the battery compartment cover ⑧.
- Insert two alkaline AA 1.5V batteries or NiMH rechargeable batteries into the battery compartment ⑩ according to the symbols. Please ensure the correct battery type is selected in the channel menu on the receiver and that synchronisation is carried out.
- Flip the battery compartment cover ⑧ back up into place. Magnets keep the cover securely in place.
- The current battery status is shown on the display on the transmitter ⑦ as well as the receiver.
- If the batteries are flat, this is indicated by an empty, flashing battery symbol on the transmitter and receiver display. In this case, you should replace the batteries with new ones as soon as possible.
- If using NiMH rechargeable batteries, you can charge these with the optionally available WA-CD battery charger. The batteries can remain in the transmitter during the charging process. Further information can be found in the separate “WA-CD” user manual.
- **Important:** From time to time, clean the battery and charging contacts of the transmitter with a soft, lint-free cloth moistened with spirit or alcohol. Always remove the batteries from the battery compartment beforehand

4.3 Initial operation of the beltpack transmitter

- Connect a microphone or the WA-CGI instrument cable to the 4-pin mini XLR connector ①.
- Switch the beltpack transmitter on by pressing and holding the on/off button ③. The operating display LED ④ will light up green.
- The transmitter display ⑦ shows the battery status as well as the name entered on the receiver.
- You can access further display functions such as frequency and transmission power by repeatedly pressing the on/off button ③.
- Ensure the transmitter and receiver are on the same frequency.
- If you hold down the on/off button ③ when switching on, you can display the version, hardware type, band and firmware version.

Figure 4-6: Battery compartment closed

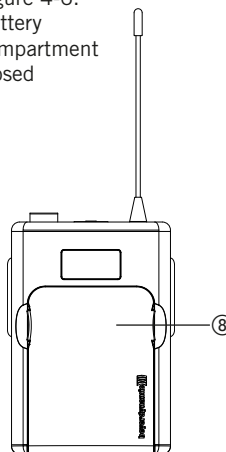

Figure 4-7: Battery compartment open

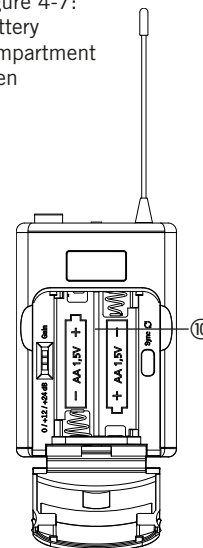

Figure 4-8: Switching on

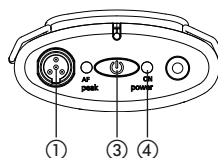

Figure 4-9: Display screen

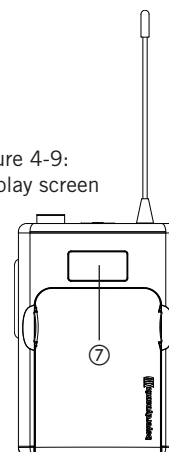

Figure 4-10: Transmitter display – Standard display



Figure 4-11: Displaying frequency

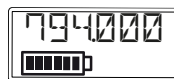

Figure 4-12: Displaying transmission power

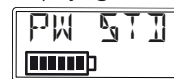

Figure 4-13: Displaying version



Figure 4-14: Displaying hardware type



Figure 4-15: Displaying band



Figure 4-16: Displaying firmware version



- To switch off the transmitter, press and hold the on/off button ③ until the “Off” message is displayed.
- If the “Tx lock” function is activated, it is still possible to switch off the transmitter. Press the on/off button ③ until the message “PW Lock” appears on the display ⑦. Release the on/off button briefly and then press it once again until the “Off” message is displayed. The transmitter is then switched off.
- If the “Mute” function on the receiver is activated, you can mute the microphone by briefly pressing the on/off button ③. The activated mute function is indicated by the “M” symbol on the display. The activated mute function is indicated both on the receiver display (“TX mute”) and on the transmitter display by the word “Mute” and the name entered on the receiver alternating on the display.
- If you wish to switch to “RF off” mode, hold down the on/off button ③ on the transmitter until the message “RF off” appears on the display. You can now synchronise a spare transmitter to the same channel, for example, even though the main transmitter is still active (audio continues to function while synchronising).
- Perform synchronisation for the spare transmitter.
- To leave “RF off” mode, turn the transmitter off and on again.

4.4 Using the sensitivity switch

- The input sensitivity can be set in three stages (0 dB / +12 dB / +24 dB).
- In addition, the output level of the receiver can be adjusted in the receiver menu. See chapter 2.8 “Menu settings”, section “Gain”.

4.5 Fastening the belt clip

- There are two belt clips for the beltpack transmitter that you can use to attach the beltpack transmitter to clothing, a belt, a guitar strap etc. The beltpack transmitter is supplied with a belt clip for upright attachment. A belt clip for sideways attachment is optionally available.
- You can remove the belt clip by pulling it out sideways from its attachment on the beltpack transmitter.
- The belt clips can be attached upright or sideways
 - Upright: to attach the transmitter to clothing or a belt, for example
 - Sideways: to attach the transmitter to a guitar strap, for example

Figure 4-17:
Switching off transmitter



Figure 4-18:
Power lock message



Figure 4-19:
Switching off in spite of power lock

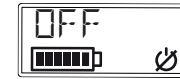

Figure 4-20:
Mute function active



Figure 4-21:
Microphone muted



Figure 4-22:
RF off mode active



Figure 4-23:
Connecting the microphone

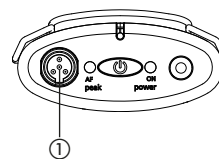

Figure 4-24:
Adjusting sensitivity

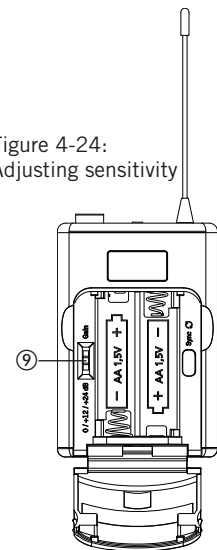

Figure 4-25:
Belt clip upright

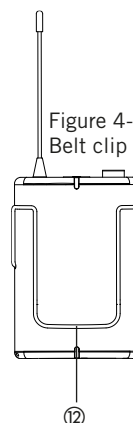
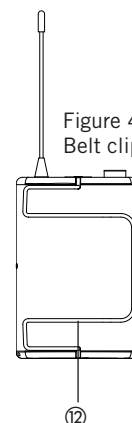

Figure 4-26:
Belt clip sideways



5. Synchronisation

- The receiver can transfer the frequency and other settings such as power lock of a particular channel to a transmitter via an infrared interface.
 - To transfer to the transmitter, press the synchronisation button ⑦ on the receiver.
 - There is an infrared interface in the transmitter's battery compartment.
 - During synchronisation, hold the infrared interface of the handheld transmitter ⑩ or the beltpack transmitter ⑪ in the **open battery compartment** of the particular **switched-on** transmitter directly in front of the infrared interface ② on the receiver.
- Important:** If the battery symbol on the transmitter display no longer shows any bars, this means the batteries are almost flat and synchronisation should thus not be performed because it will not be completed or will be terminated.

Synchronising two transmitters to the same channel

- Press and hold the on/off button on the handheld ① or beltpack transmitter ③ for around 8 seconds to go into "RF off" mode. You can now synchronise a spare transmitter to the same channel, for example, even though the main transmitter is still active (audio continues to function while synchronising).
 - Perform synchronisation for the spare transmitter as described above.
 - To leave "RF off" mode, turn the transmitter off and on again.
- Important:** Before switching the spare transmitter off and on again, you must switch off the main transmitter, otherwise there will be interference on the channel if two transmitters are active on the same frequency.

6. Instructions for all transmitters

- Check the charging status of the transmitter battery/batteries and replace if necessary. Only use new alkaline batteries or charged rechargeable batteries.
- Switch the transmitter off before replacing the batteries.
- If you do not use the transmitter for weeks or months, please remove the batteries. Batteries may leak after long periods of non-use and may corrode circuit paths and components. This means repairs will no longer be possible. In this case, all warranty claims will be void. Even the description "Leak proof" on batteries is not a guarantee against leaks.
- From time to time, clean the battery contacts with a soft cloth moistened with spirit or alcohol.
- Do not dispose of used batteries in the household waste. Instead, take them to local collection points.
- To charge the batteries, use standard battery chargers or the WA-CD charger from beyerdynamic.

Figure 5-1: Synchronising the transmitter with the receiver

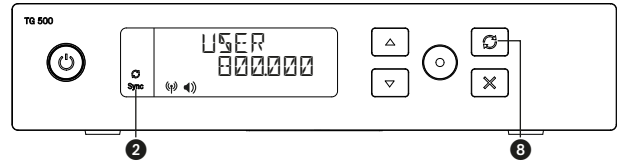

Figure 5-2: Synchronising the handheld transmitter

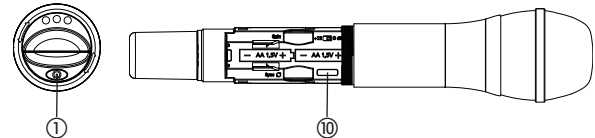
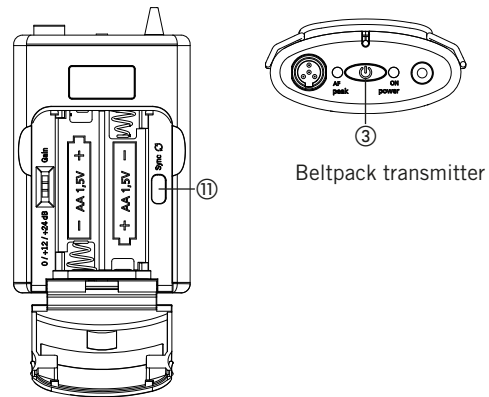

Figure 5-3: Synchronising the beltpack transmitter



Beltpack transmitter

7. Components

Diversity receiver

TG 500SR	Single-channel diversity receiver, including power cable, 2 x WA-ATS standard omnidirectional antennas, 1 x WA-CKF connection cable for antenna front mounting, Rack Mount Kit and Quick Start Guide, 518–548 MHz.	Order # 712.272
TG 500SR	same as above, but 606 - 636 MHz	Order # 712.280
TG 500SR	same as above, but 794 - 832 MHz	Order # 712.299
TG 500SR	same as above, but 1785 - 1805 MHz	Order # 712.310
TG 500DR	Two-channel diversity receiver, including power cable, 2 x WA-ATS standard omnidirectional antennas, 1 x WA-CKF connection cable for antenna front mounting, Rack Mount Kit and Quick Start Guide, 518–548 MHz.	Order # 712.329
TG 500DR	same as above, but 606 - 636 MHz	Order # 712.337
TG 500DR	same as above, but 794 - 832 MHz	Order # 712.345
TG 500DR	same as above, but 1785 - 1805 MHz	Order # 712.361

Handheld transmitter

TG 500H-D	Handheld transmitter with TG V50 dynamic microphone head (cardioid), including batteries, 518–548 MHz.	Order # 712.167
TG 500H-D	same as above, but 606 - 636 MHz	Order # 712.175
TG 500H-D	same as above, but 794 - 832 MHz	Order # 712.159
TG 500H-D	same as above, but 1785 - 1805 MHz	Order # 712.191
TG 500H-C	Handheld transmitter with TG V56 condenser microphone head (cardioid), including batteries, 518–548 MHz.	Order # 712.205
TG 500H-C	same as above, but 606 - 636 MHz	Order # 712.213
TG 500H-C	same as above, but 794 - 832 MHz	Order # 712.221
TG 500H-C	same as above, but 1785 - 1805 MHz	Order # 712.264

Beltpack transmitter

TG 500B	Beltpack transmitter, including batteries, 518–548 MHz.	Order # 712.108
TG 500B	same as above, but 606 - 636 MHz	Order # 712.116
TG 500B	same as above, but 794 - 832 MHz	Order # 712.124
TG 500B	same as above, but 1785 - 1805 MHz	Order # 712.140

8. Sets

TG 510	Instrument set consisting of: TG 500B beltpack transmitter, batteries and WA-CGI instrument cable, TG 500SR single-channel receiver with power adaptor, two antennas and Rack Mount Kit, 518 - 548 MHz.	Order # 712.388
TG 510	same as above, but 606 - 636 MHz	Order # 712.396
TG 510	same as above, but 794 - 832 MHz	Order # 712.418
TG 510	same as above, but 1785 - 1805 MHz	Order # 712.434
TG 534	Headworn set consisting of: TG 500B beltpack transmitter, batteries and TG H34 headset (cardioid), TG 500SR single-channel receiver with power adaptor, two antennas and Rack Mount Kit, 518 - 548 MHz.	Order # 712.442
TG 534	same as above, but 606 - 636 MHz	Order # 712.450
TG 534	same as above, but 794 - 832 MHz	Order # 712.469
TG 534	same as above, but 1785 - 1805 MHz	Order # 712.507
TG 550	Vocal set consisting of: TG 500H-D handheld transmitter with TG V50 dynamic capsule (cardioid) and batteries, TG 500SR single-channel receiver with power adaptor, two antennas and Rack Mount Kit, 518 - 548 MHz.	Order # 712.515
TG 550	same as above, but 606 - 636 MHz	Order # 712.523
TG 550	same as above, but 794 - 832 MHz	Order # 712.531
TG 550	same as above, but 1785 - 1805 MHz	Order # 712.566
TG 556	Vocal set consisting of: TG 500H-C handheld transmitter with TG V56 condenser capsule (cardioid) and batteries, TG 500SR single-channel receiver with power adaptor, two antennas and Rack Mount Kit, 518 - 548 MHz.	Order # 712.574
TG 556	same as above, but 606 - 636 MHz	Order # 712.582
TG 556	same as above, but 794 - 832 MHz	Order # 712.590
TG 556	same as above, but 1785 - 1805 MHz	Order # 712.612

TG 558	Presenter set consisting of: TG 500B belt-pack transmitter and TG L58 lavalier microphone (spherical) and batteries, TG 500SR single-channel receiver with power adaptor, two antennas and Rack Mount Kit, 518 - 548 MHz	Order # 712.620
TG 558	same as above, but 606 - 636 MHz	Order # 712.639
TG 558	same as above, but 794 - 832 MHz	Order # 712.647
TG 558	same as above, but 1785 - 1805 MHz	Order # 712.663

9. Optional accessories

Diversity receiver

Antenna splitter/Combiner

WA-AS4	4-way antenna splitter for wireless systems with BNC connection, 8 V DC antenna supply, internal power supply, incl. connecting cables and DC outputs for a maximum of two TG 500SR, 470 – 1810 MHz	Order # 710.938
WA-ZAPD1	Passive 2-way combiner with BNC connector, 470–790 MHz.	Order # 711.217

Antennas

WA-ATDA	Passive/active broadband directional antenna for wireless systems with BNC connector, 470–790 MHz	Order # 711.004
WA-ATDA 1G8	Active wideband directional antenna with integrated amplifier for wireless systems with BNC connection, optional voltage supply via WA-PSU 12/1, 1400 – 1810 MHz	Order # 727.881
WA-ATO	Broadband omnidirectional antenna for wireless systems with BNC 470–790 MHz	Order # 711.586

Cables

WA-AC25	BNC antenna cable, length 25 metres, low-loss Aircell 7 cable	Order # 711.578
WA-AC10	BNC antenna cable, length 10 metres, low-loss Aircell 7 cable	Order # 711.551
WA-AC5	BNC antenna cable, length 5 metres, low-loss Aircell 7 cable	Order # 711.543
WA-CGI	Connection cable for connecting instruments with 6.35mm mono jack plug	Order # 711.608
WA-ADF	Antenna front mounting adapter, 2 BNC adapters female/female, WA-CKL60 required for use	Order # 712.795
WA-CKL60	Connection cable set with 2 RG 58 connecting cables, 60 cm long, for cascading or antenna front mounting	Order # 712.809

Handheld transmitter

WA-MS	Colour ring set consisting of 6 colour rings (black, red, yellow, green, white, blue)	Order # 711.152
-------	---	-----------------

Belt-pack transmitter

Microphones

TG H34 (TG)	Neckworn microphone, condenser, supercardioid, black, with 4-pin mini XLR connector, including pop shield	Order # 706.477
TG H56 (TG)	Headset microphone, condenser, spherical, black, with 4-pin mini XLR connector, including pop shield	Order # 705.888
TG H56 tan (TG)	same as above, but beige	Order # 705.853
TG H74 (TG)	Neckworn microphone, condenser, cardioid, with 4-pin mini XLR connector, black	Order # 708.364
TG H74 tan (TG)	same as above, but beige	Order # 708.372
TG I57 (TG)	Clip-on instrument microphone, condenser, cardioid, black, with 4-pin mini XLR connector	Order # 708.356
TG L58 (TG)	Miniature condenser microphone, spherical, 6 mm capsule diameter, with 4-pin mini XLR connector, black	Order # 706.221
TG L58 tan (TG)	same as above, but beige	Order # 705.926

Charger

WA-CD	Charger for TG 500 belt-pack transmitter and TG 500 handheld transmitter as well as Quinta TH with 4 charging compartments and Ethernet control; charges up to 2 handheld and 2 belt-pack transmitters or 2 handheld transmitters and 4 NiMH rechargeable batteries at the same time.	Order # 711.144
-------	---	-----------------

10. Technical specifications

System

Frequency ranges	518 – 548 MHz 606 – 636 MHz 794 – 832 MHz 1785 – 1805 MHz
Operating range	up to 120m (line of sight) Number of simultaneously active channels. 18 per frequency band
Audio frequency response	45–15 kHz
Audio dynamic range.	106 dB (A-weighted)
Operating principle	Analogue wireless microphone system with diversity receiver

Single-channel receiver

Output level	max. +7 dBu
Display	LCD, white backlit
Mains connection	100–240V AC with power adaptor
Power consumption.	3W (typ.)
Ambient temperature	0 to +55°C
Weight.	960g
Dimensions	200 x 175 x 42mm
Antenna connector	2 x BNC input

Two-channel receiver

Output level	max. +7 dBu
Display	2 x LCD, white backlit
Mains connection	100–240V AC with integrated power supply
Power consumption.	11W (typ.)
Ambient temperature	0 to +55°C
Weight.	2100g
Dimensions	400 x 175 x 42mm
Antenna connector	2 x BNC input
Antenna power supply	8V DC / 150 mA

UHF handheld transmitter

Display	LCD
Power supply	2 x AA NiMH or alkaline batteries
Operating life	approx. 10 hours
Ambient temperature	0 to +55°C
Transmission power.	10 mW / 50 mW
Weight (without batteries)	TG 500H-C: 180 g TG 500H-D: 230 g
Dimensions:	
Length including microphone capsule.	TG 500H-C: 263 mm TG 500H-D: 260 mm
Shaft diameter	36 mm
Capsule diameter	TG 500H-C: 48 mm TG 500H-D: 53 mm

UHF beltpack transmitter

Display	LCD
Power supply	2 x AA NiMH or alkaline batteries
Operating life	approx. 10 hours
Ambient temperature	0 to +55°C
Transmission power.	10 mW / 50 mW
Weight (without batteries)	85g
Dimensions	90 x 59 x 26mm (without antenna)

11. Service

When servicing is required, please contact an authorised professional. Never open the device yourself, as this will invalidate all warranty claims.

12. Authorisation and registration obligation

Before operating your radio microphone system or other audio transmission applications, ask the responsible supervisory authority for frequency utilisation for the exact frequency allocations and apply for any individual licence required. In Germany, the branch offices of the Federal Network Agency (www.bundesnetzagentur.de) are responsible for this.

Important:

Depending on the frequency range and region, wireless systems may require a broadcasting licence and may be subject to registration and fees. In Germany, all wireless microphones may be used in the UHF range 823 to 832 MHz and 1785 to 1805 MHz without registration and therefore do not require a licence or fees.

For professional users in Germany, frequency ranges requiring registration are from 518 to 548 MHz and 606 to 636 MHz.

Frequency bands 3 and 4 also allow for operation outside of the universally allocated (and therefore free-of-charge) frequency range. It is the responsibility of the user to set suitable frequencies.

Current information about regulations regarding the operation of wireless systems in Germany can be found at: www.bundesnetzagentur.de

The components of the TG 500 system are licensed in accordance with EU Directive 2014/53/EU as follows: "TG 500B Beltpack Transmitter" "TG 500H Handheld Transmitter"

13. Simplified EU declaration of conformity

beyerdynamic hereby declares that the wireless transmission device complies with the EU Directive 2014/53/EU. The complete text of the EU declaration of conformity is available online at the following address:

<http://www.beyerdynamic.com/cod>

www.beyerdynamic.com



beyerdynamic GmbH & Co. KG

Theresienstraße 8 · 74072 Heilbronn · Germany

For further distributors worldwide, please go to www.beyerdynamic.com

Non-contractual illustrations. Subject to change without notice.

Weitere Vertriebspartner weltweit finden Sie im Internet unter www.beyerdynamic.com

Abbildungen nicht vertragsbindend. Änderungen vorbehalten.

EN 4/BA TG 500 (04.19)