

A	B	C	D	
1	S162 0006A	494	176	2/2
2	S162 0016A	494	200	2/2
3	S162 1112	477	371	1/2
4	S162 1113	477	371	1/2
5	S162 2203	522	397	1/2
6	S162 4404	488	60	1/2
7	S162 4405	488	60	1/2
8	S162 4408	488	60	1/2
9	S162 9971	453	355	1/2
10	S162 9909	442	256	1/2
11	BB 511	350	120	1/2
12	BB 512	350	120	1/2
13	ZB 5520	431	120	1/2
14	Lh 412	412	14	1/2

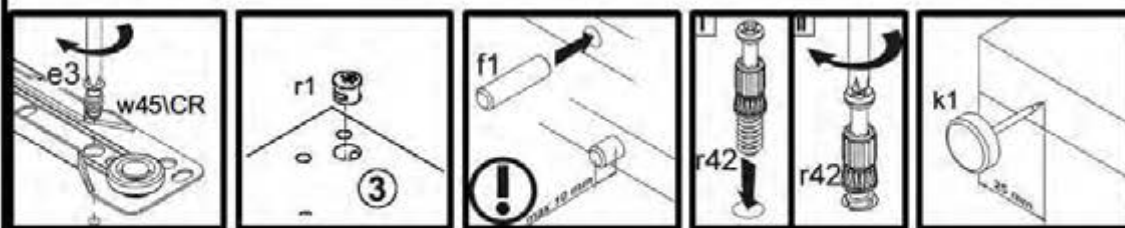

2

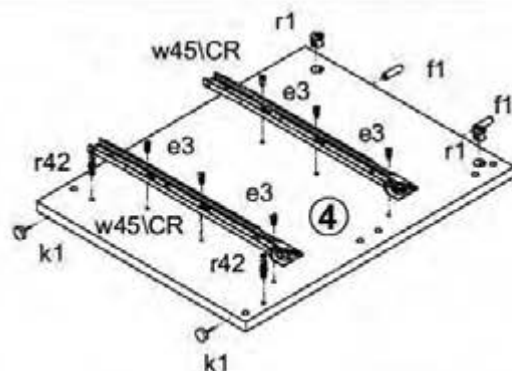
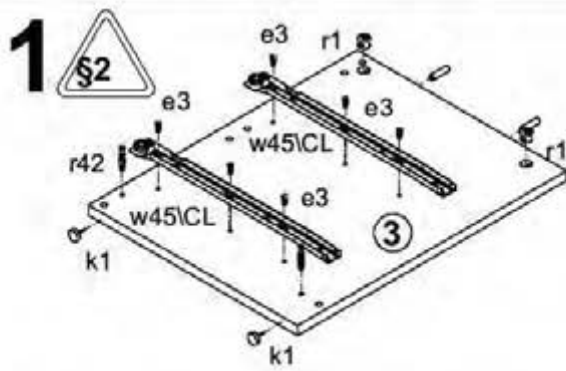
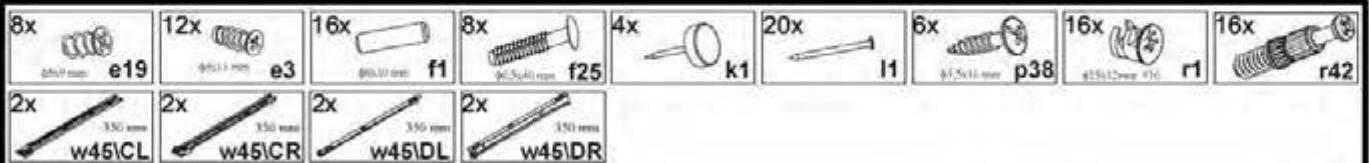
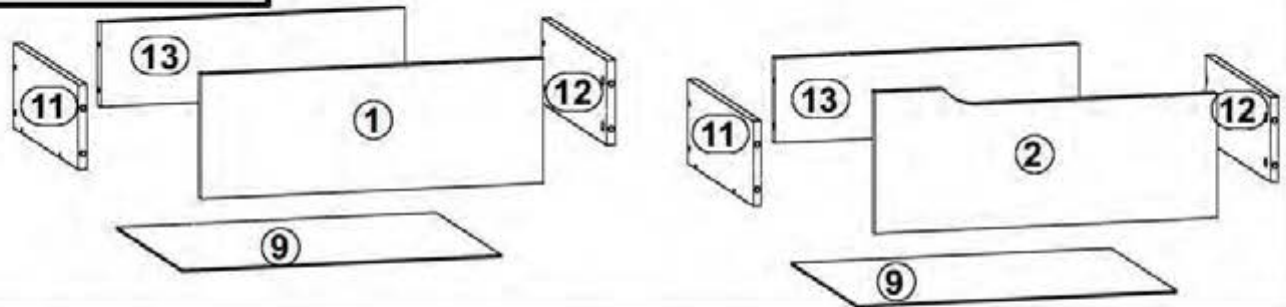
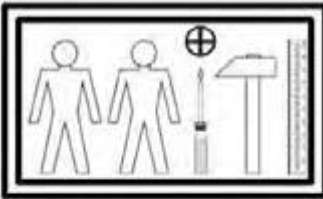
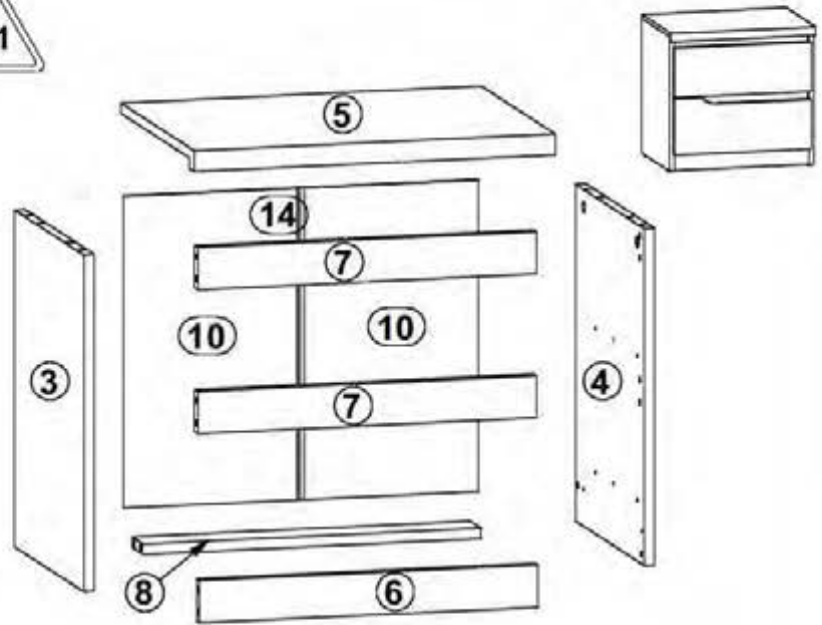
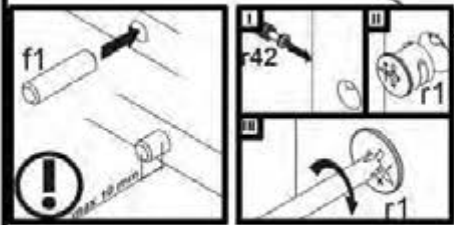
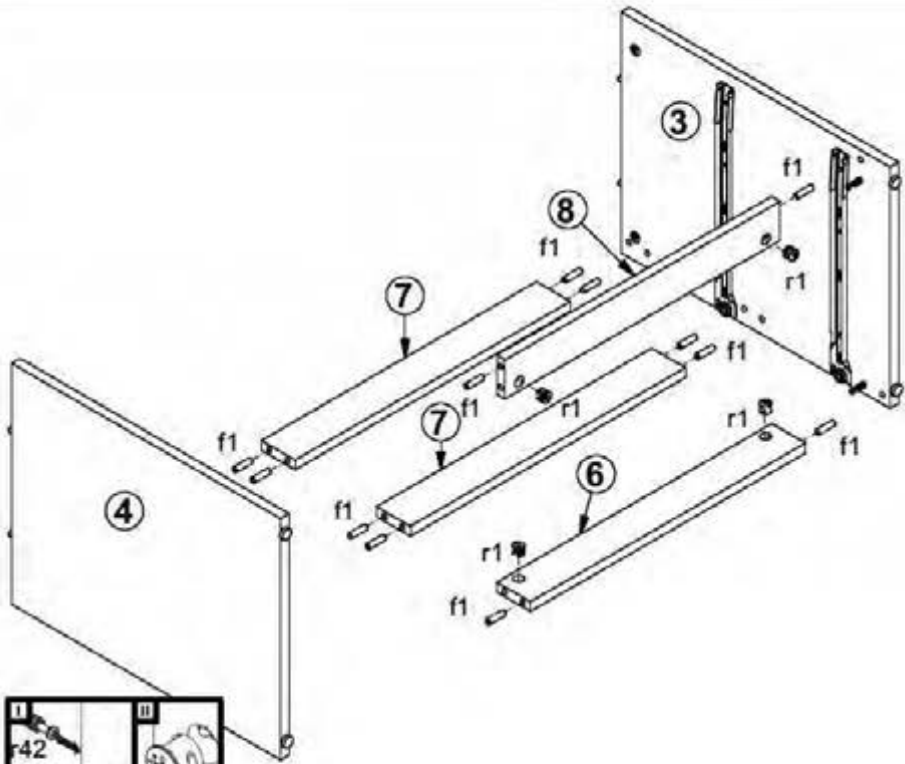

3

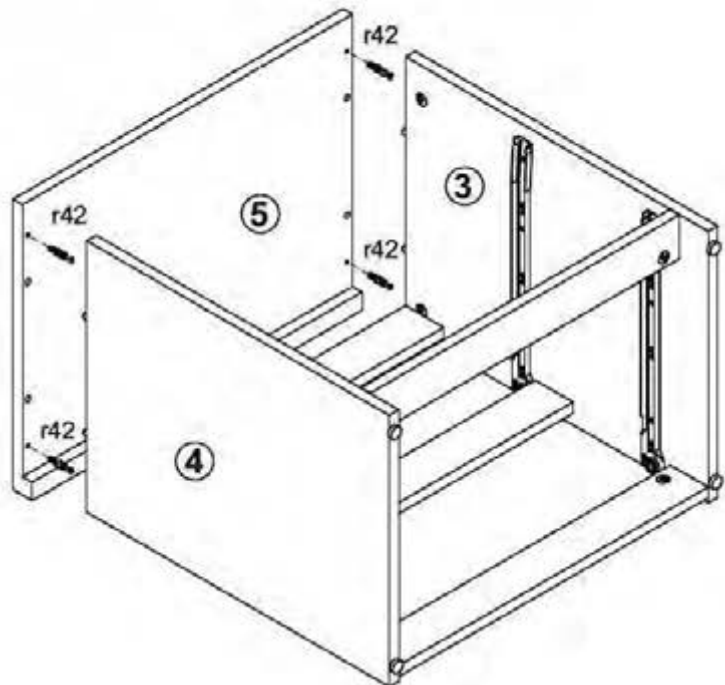

4

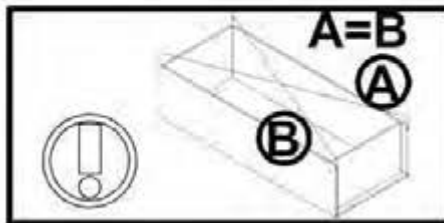
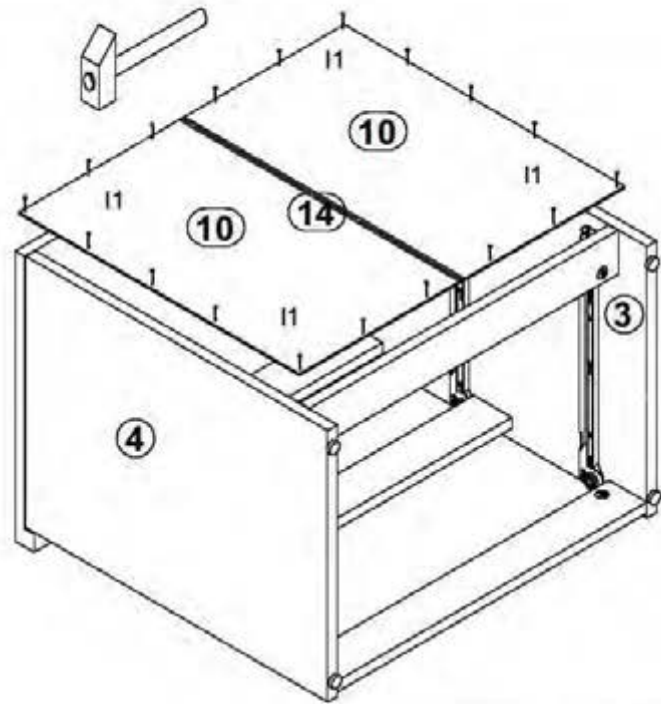

5

