

CITY

LEGO

60277

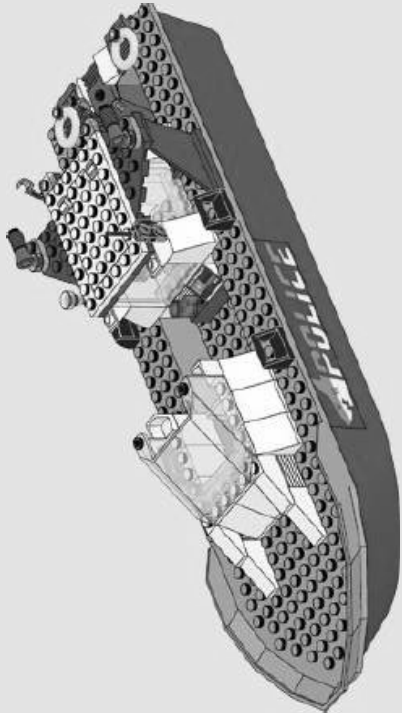

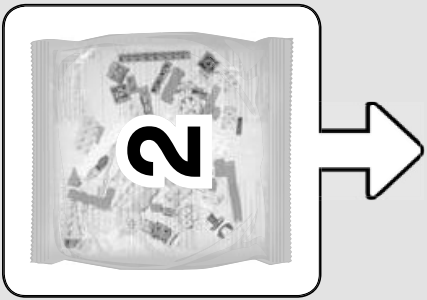
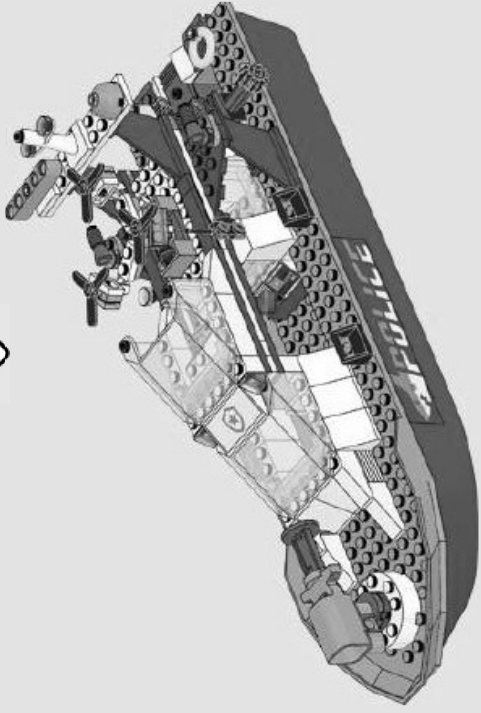
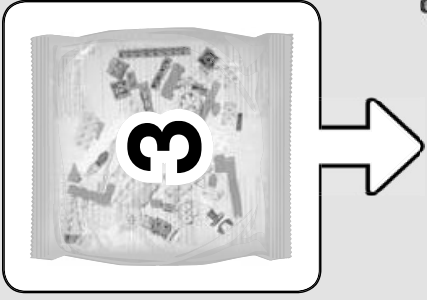

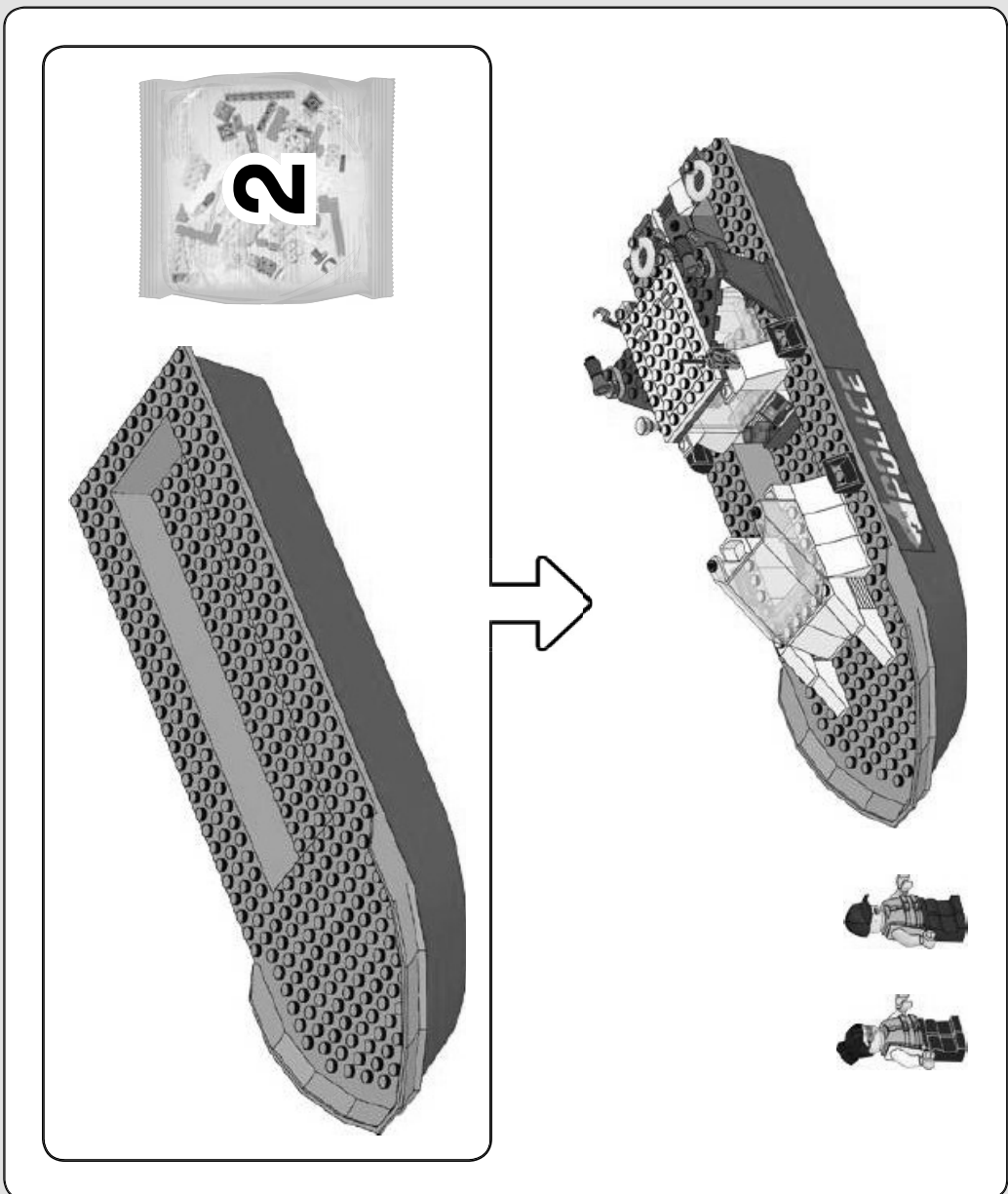
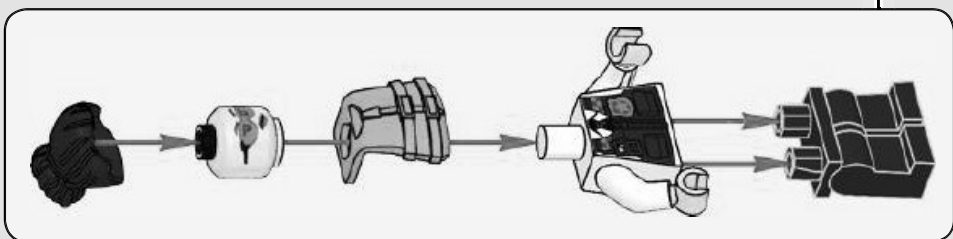
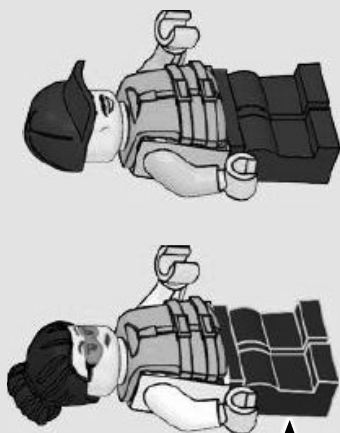

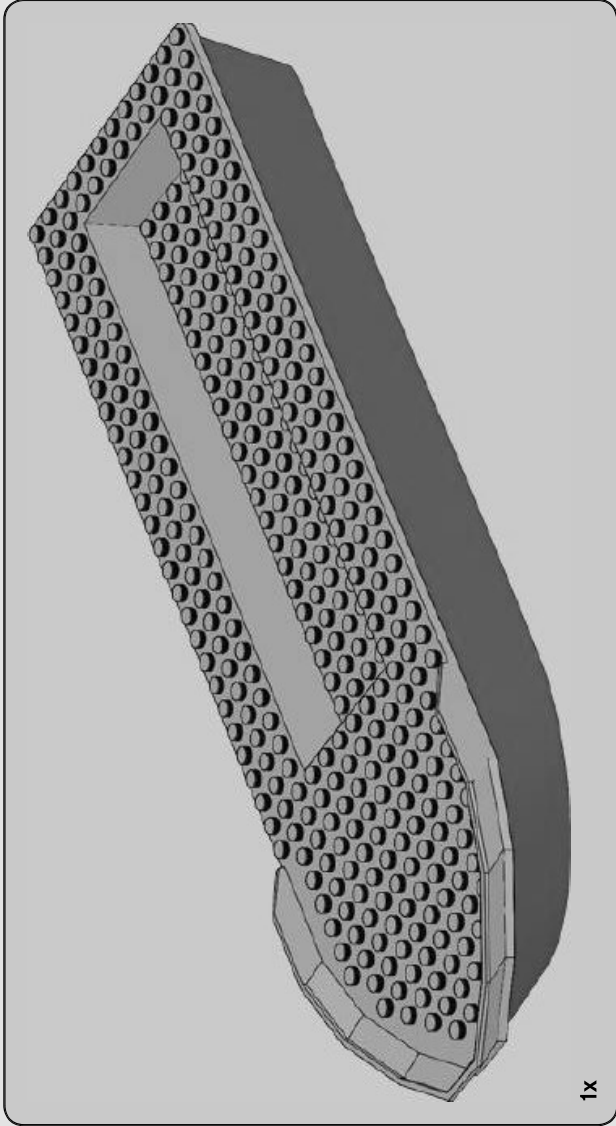

1

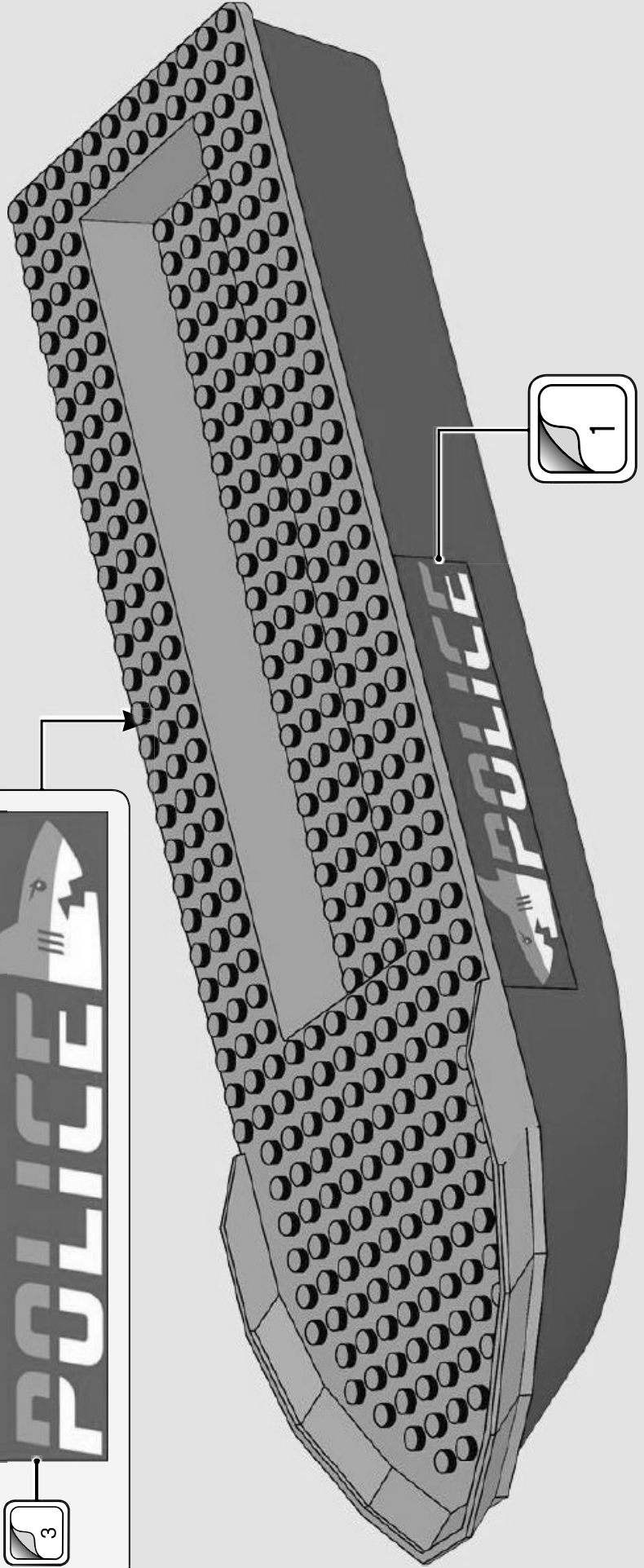
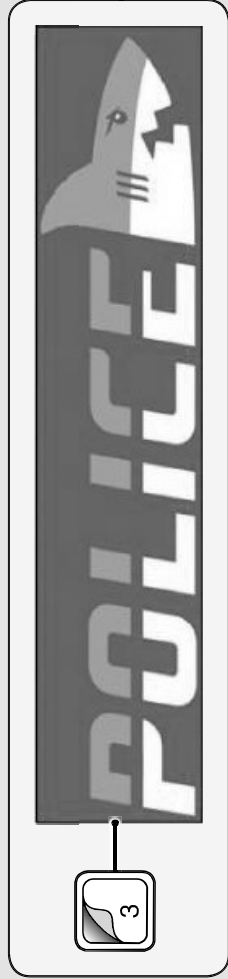

4

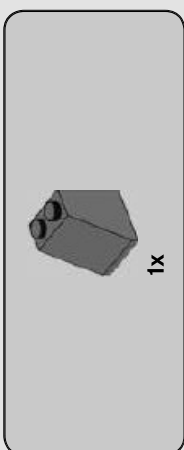
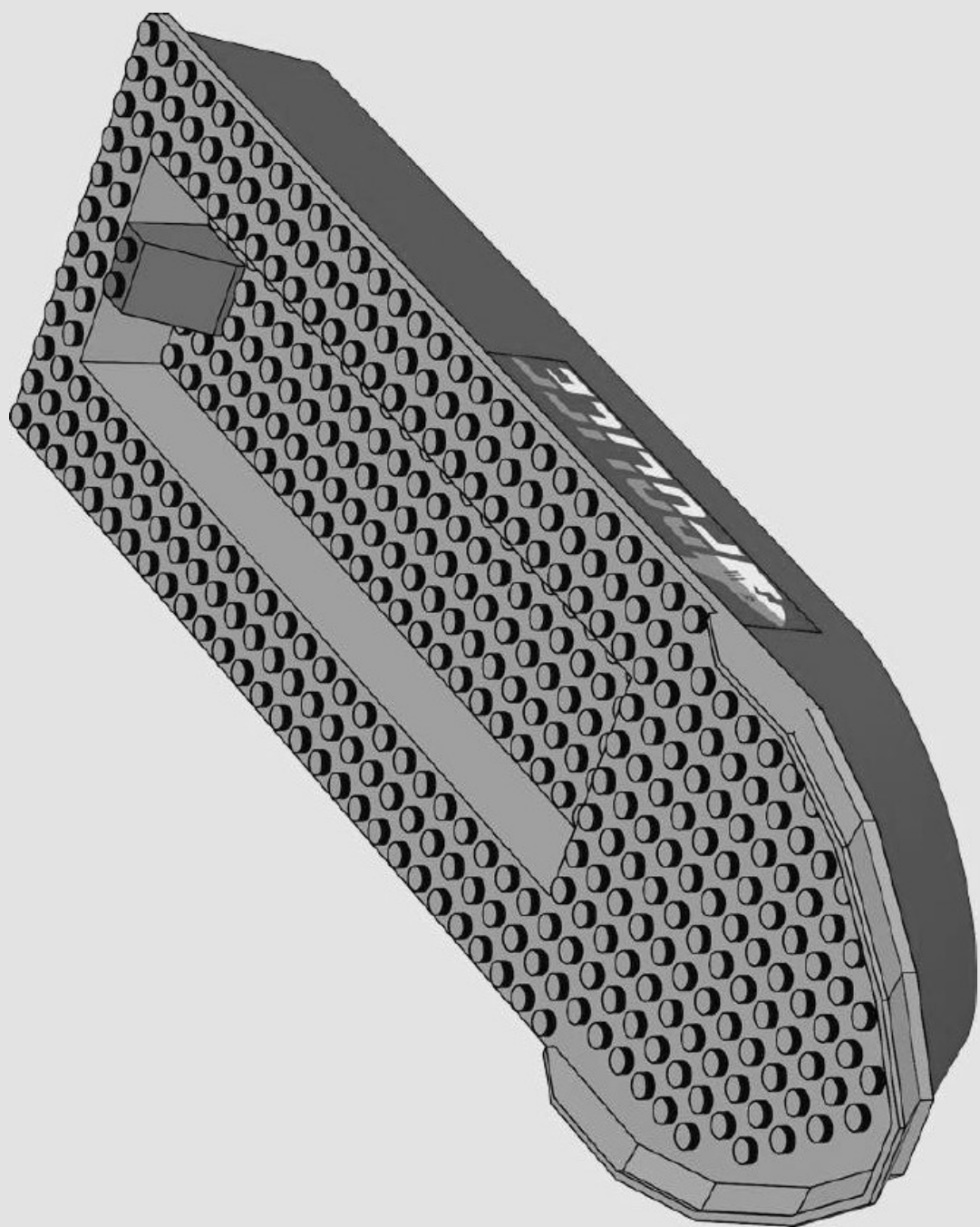

2

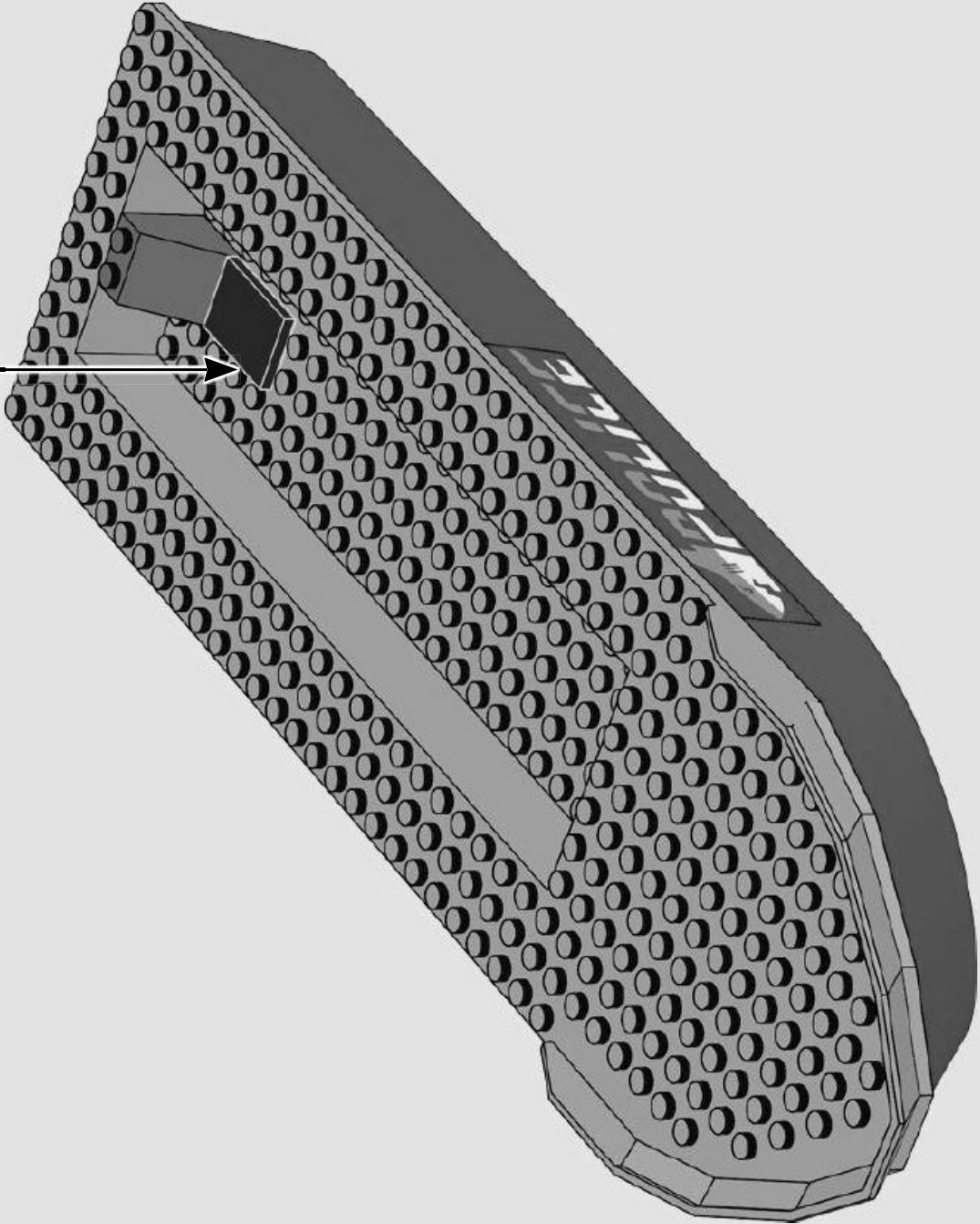

3

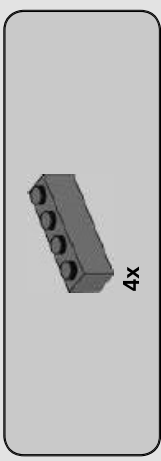
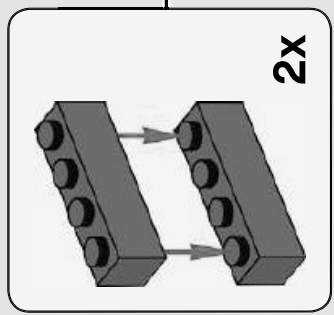
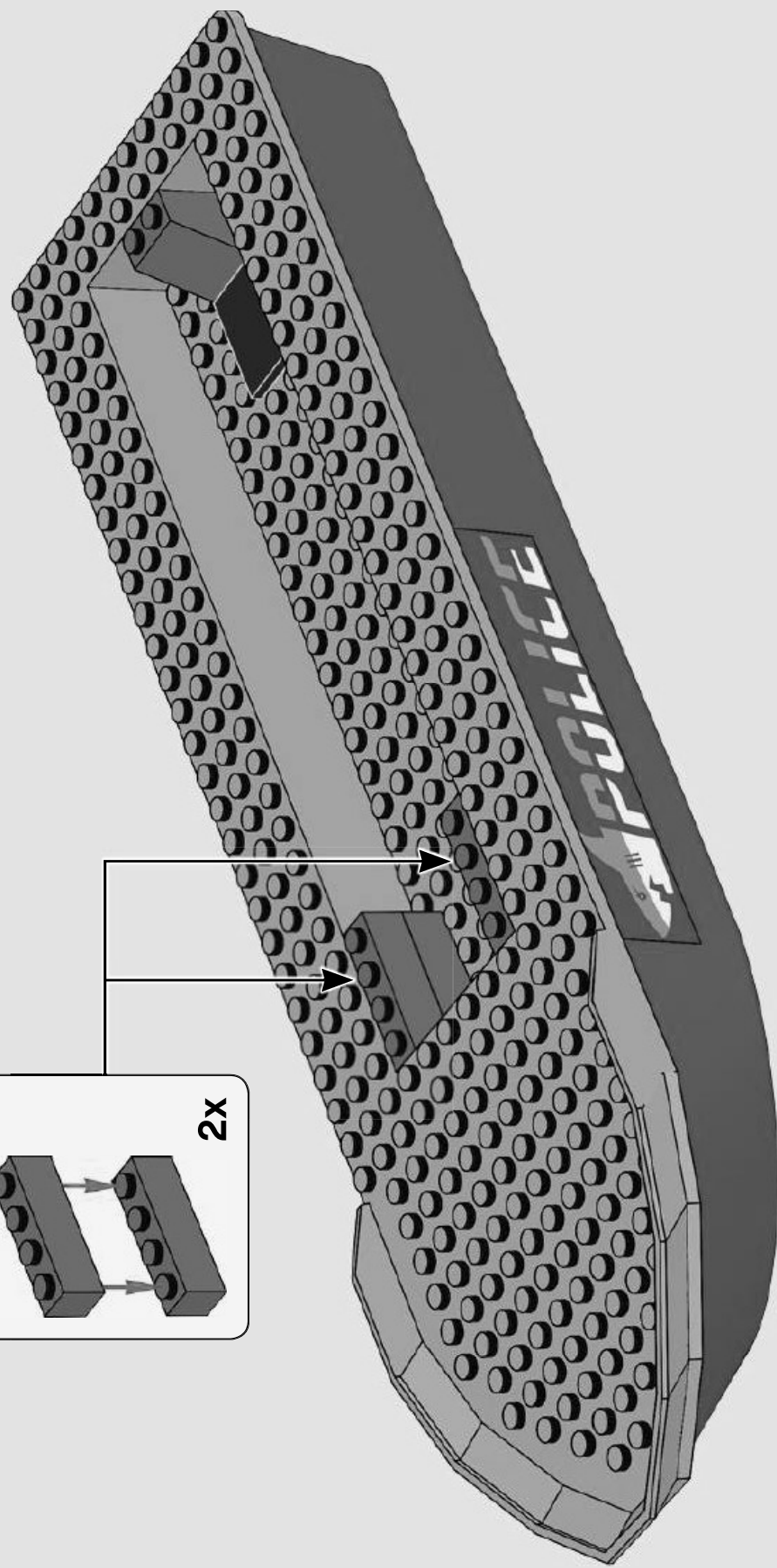



4

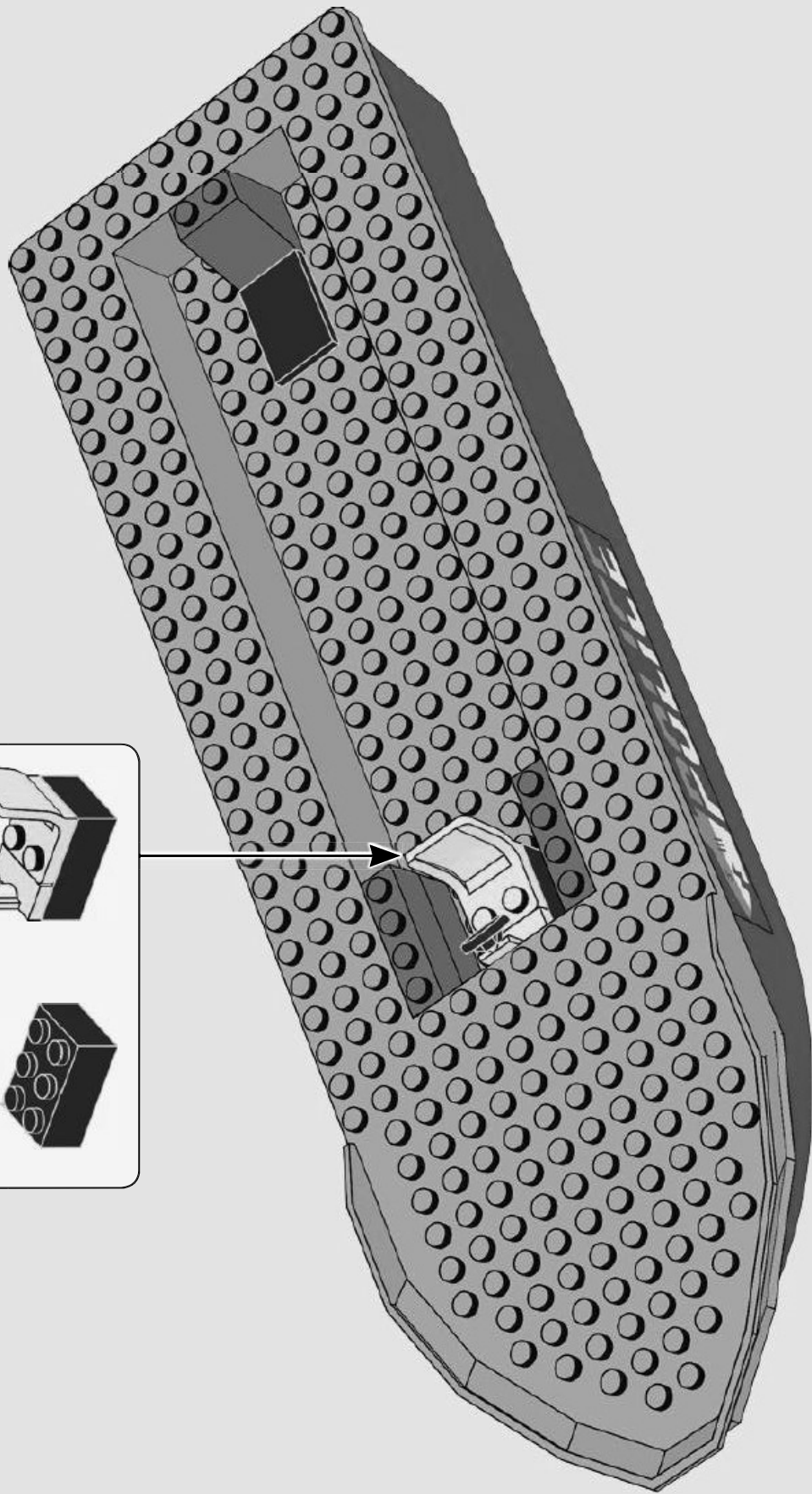
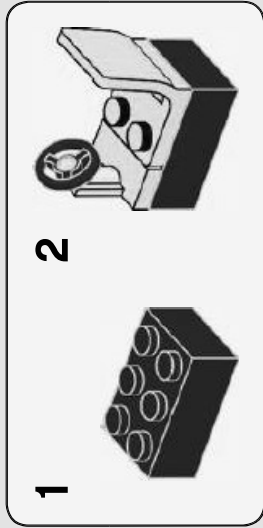

5

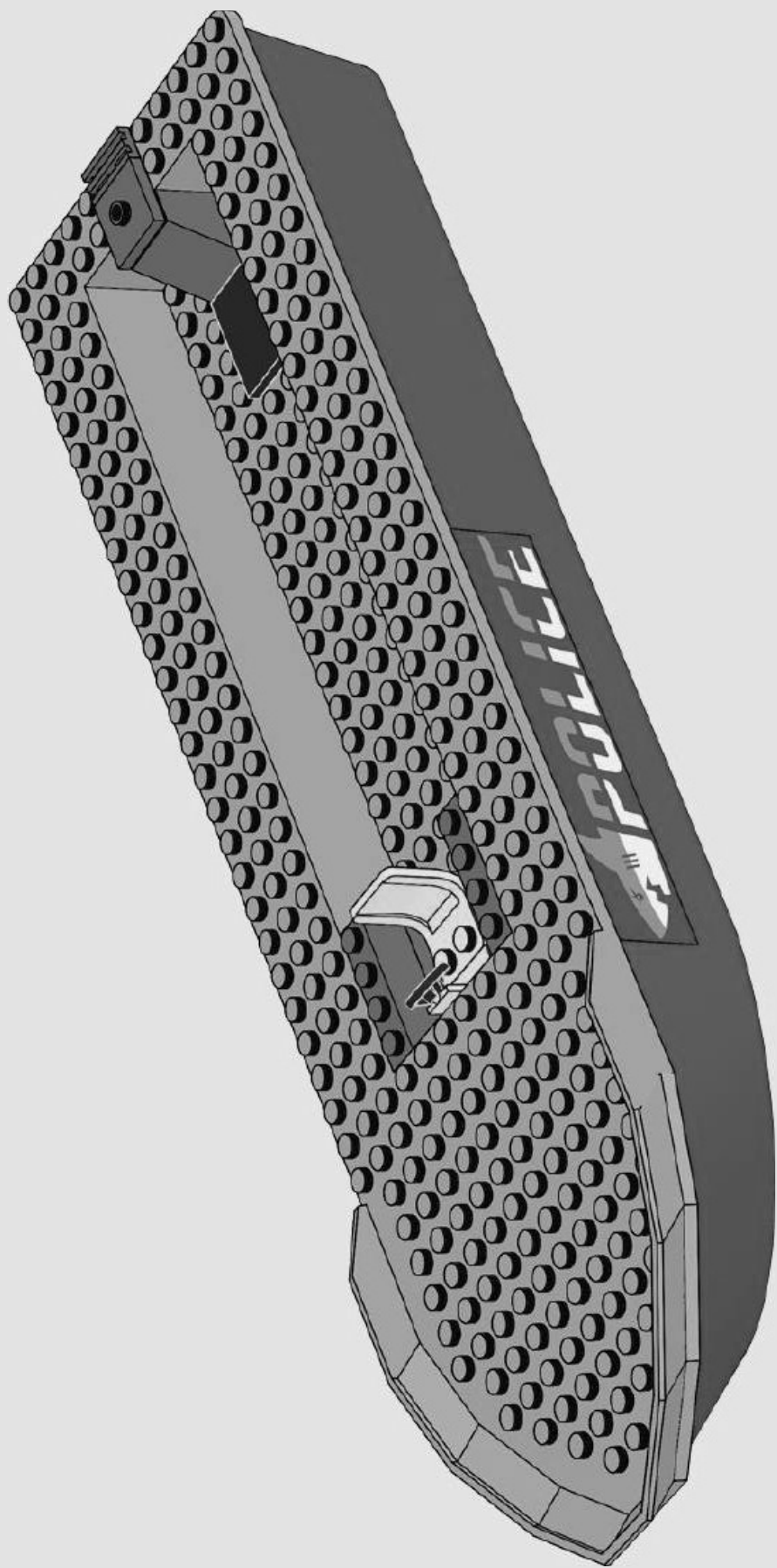



1x 

1x 

6

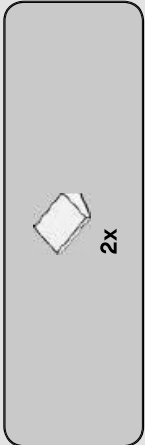
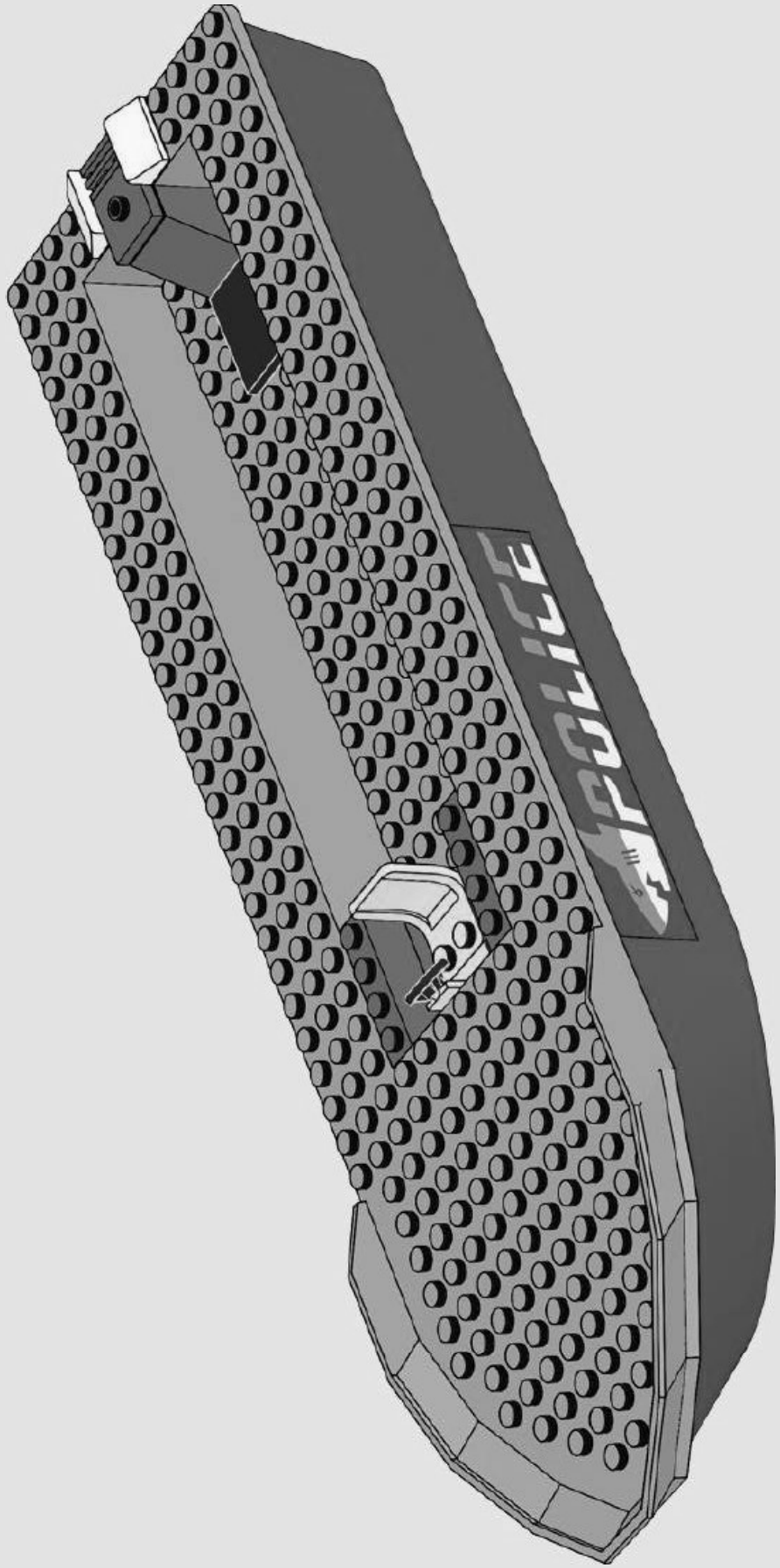

7

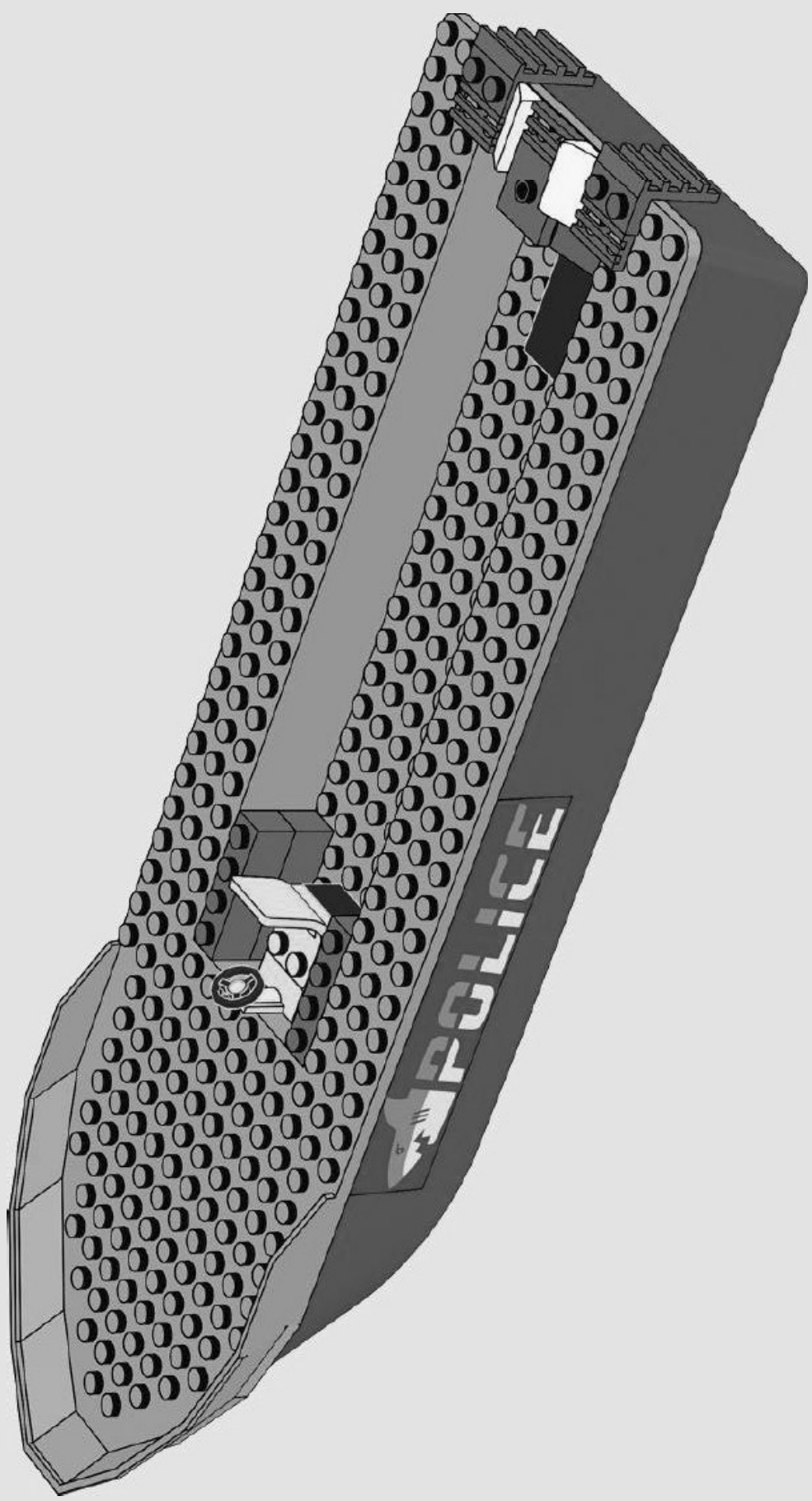

2x



2x



8

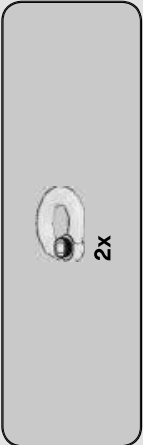
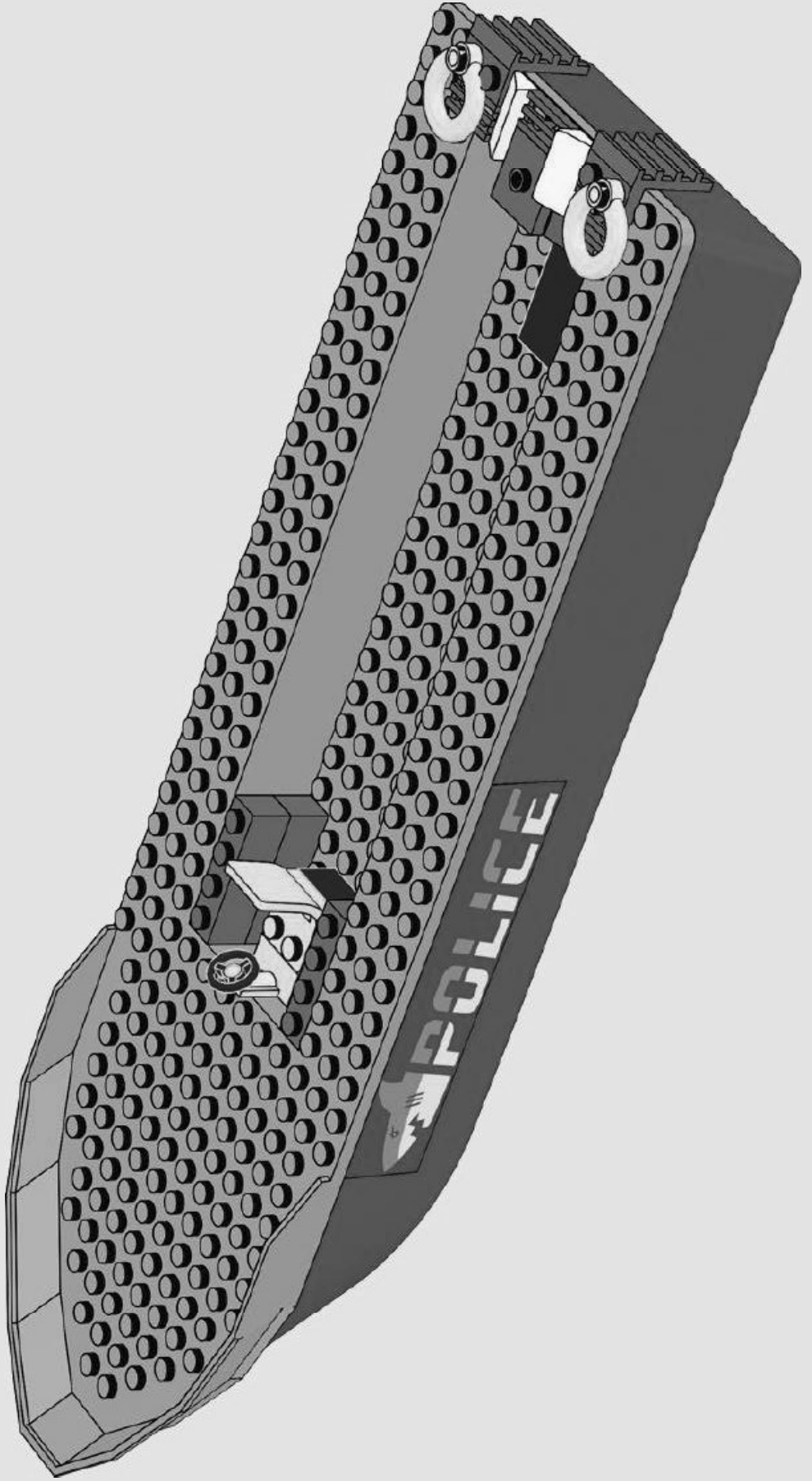

9

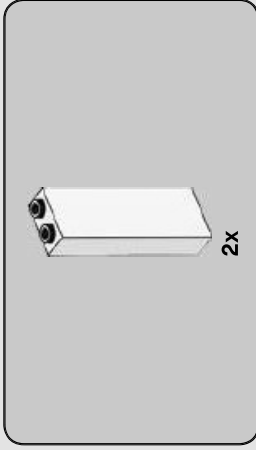
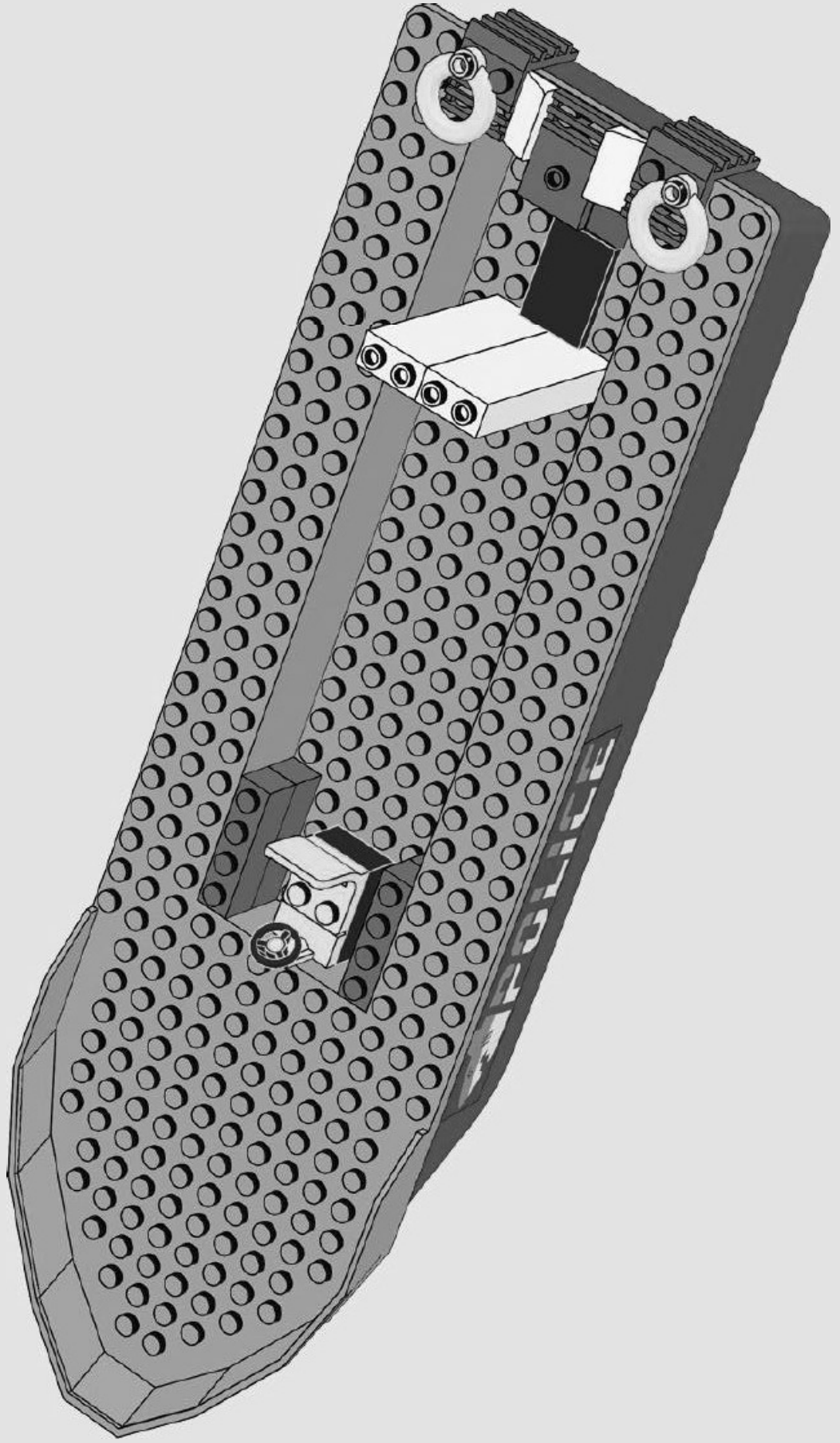

10

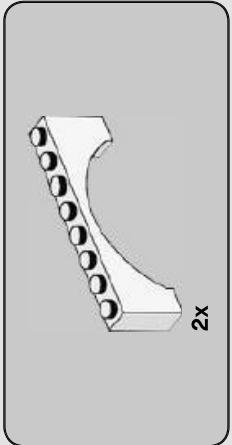
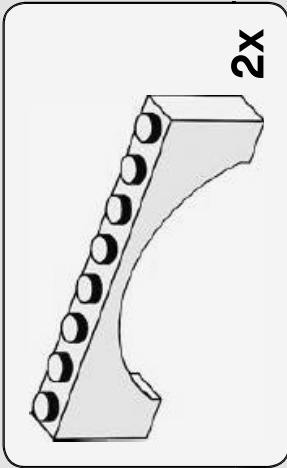
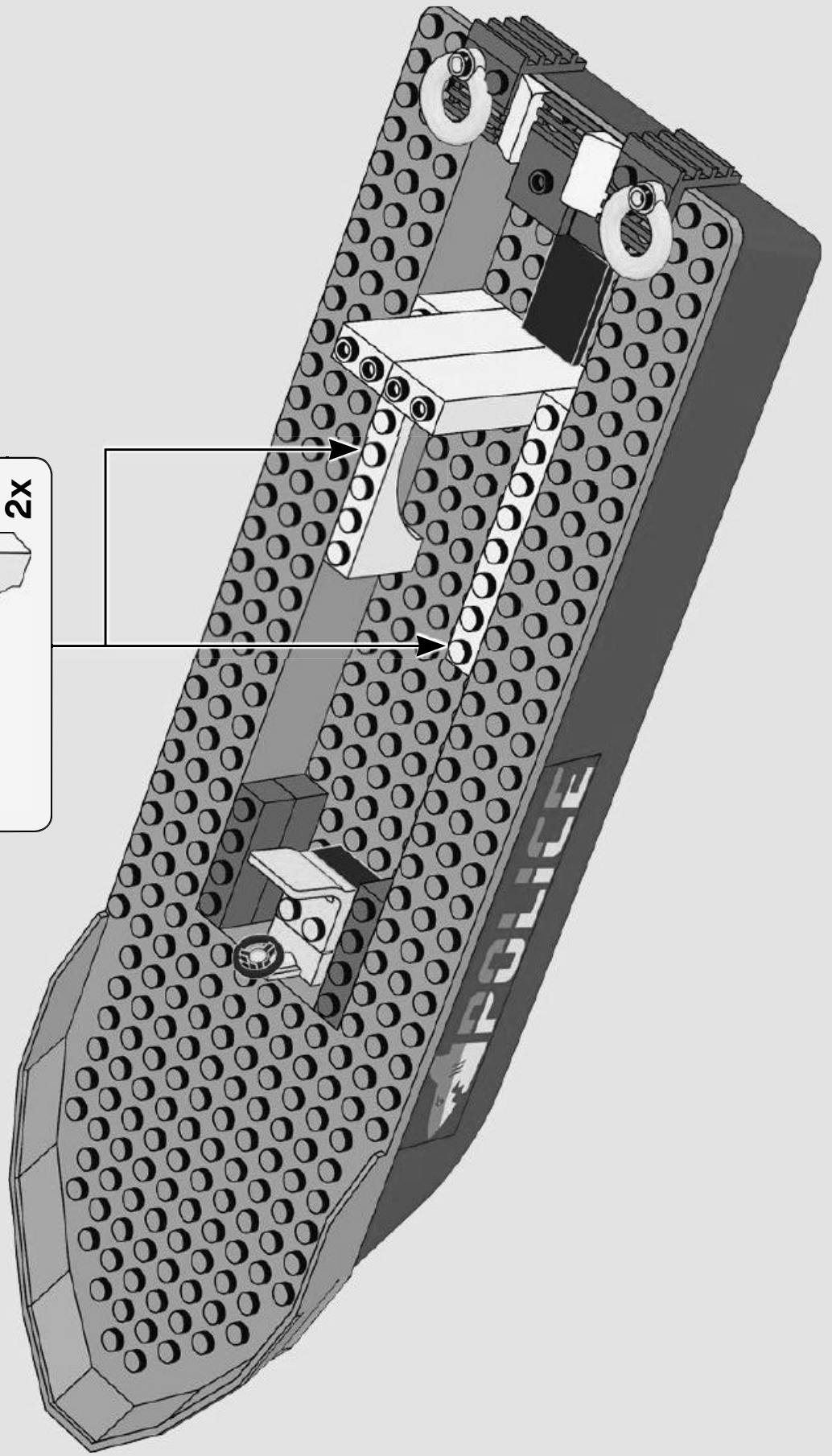

11

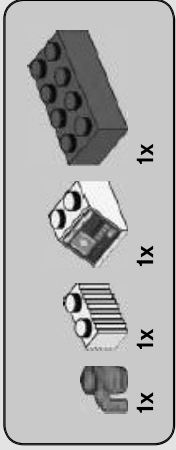

12

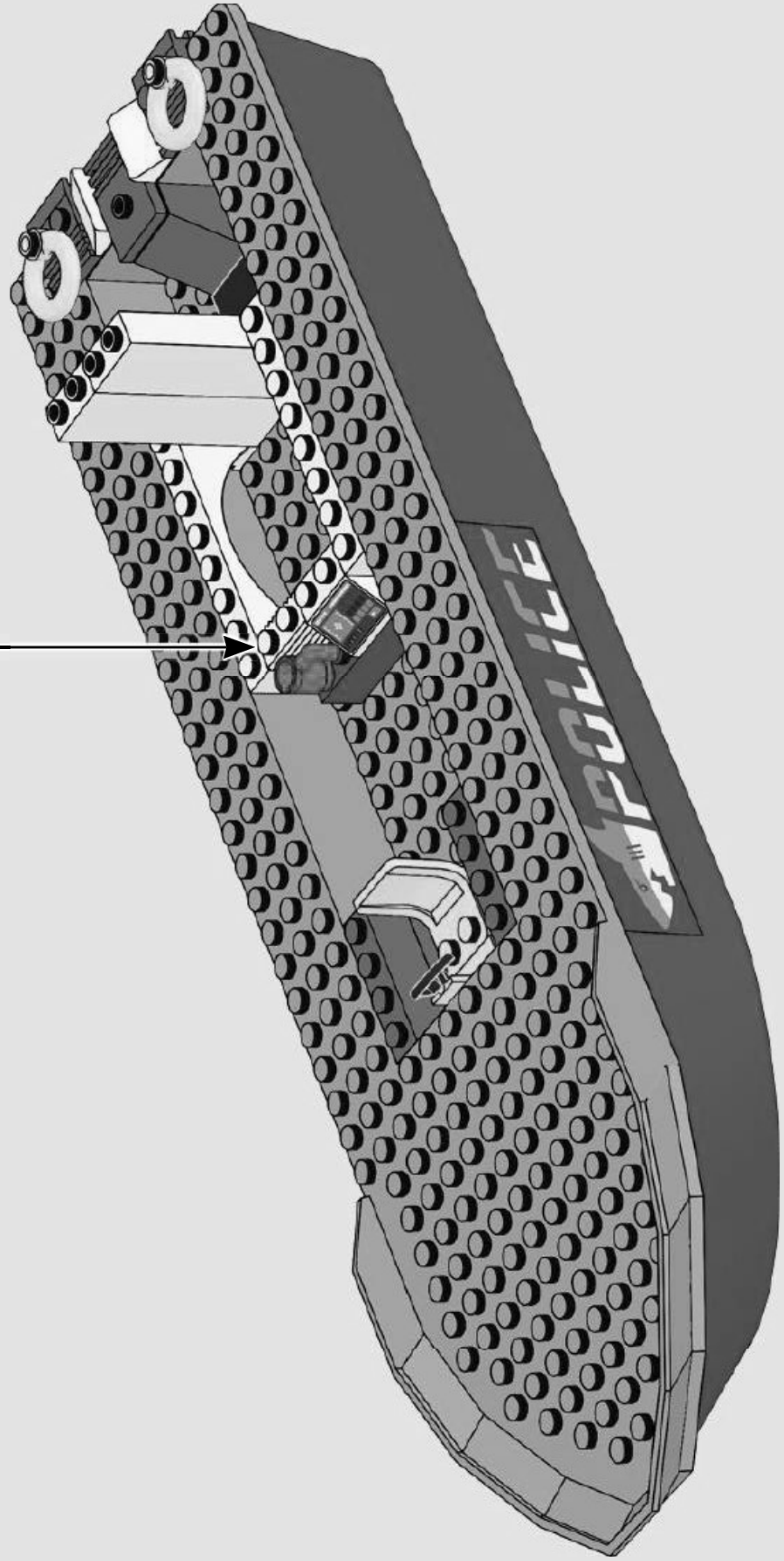
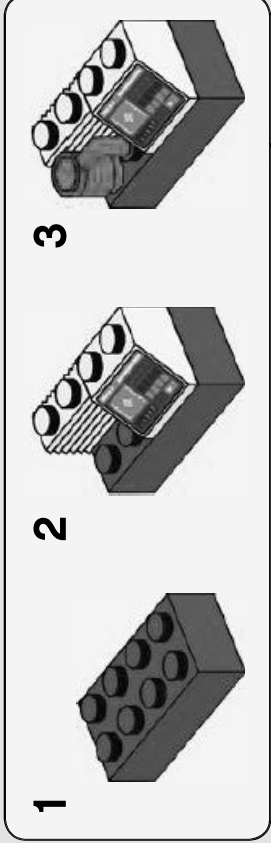



13

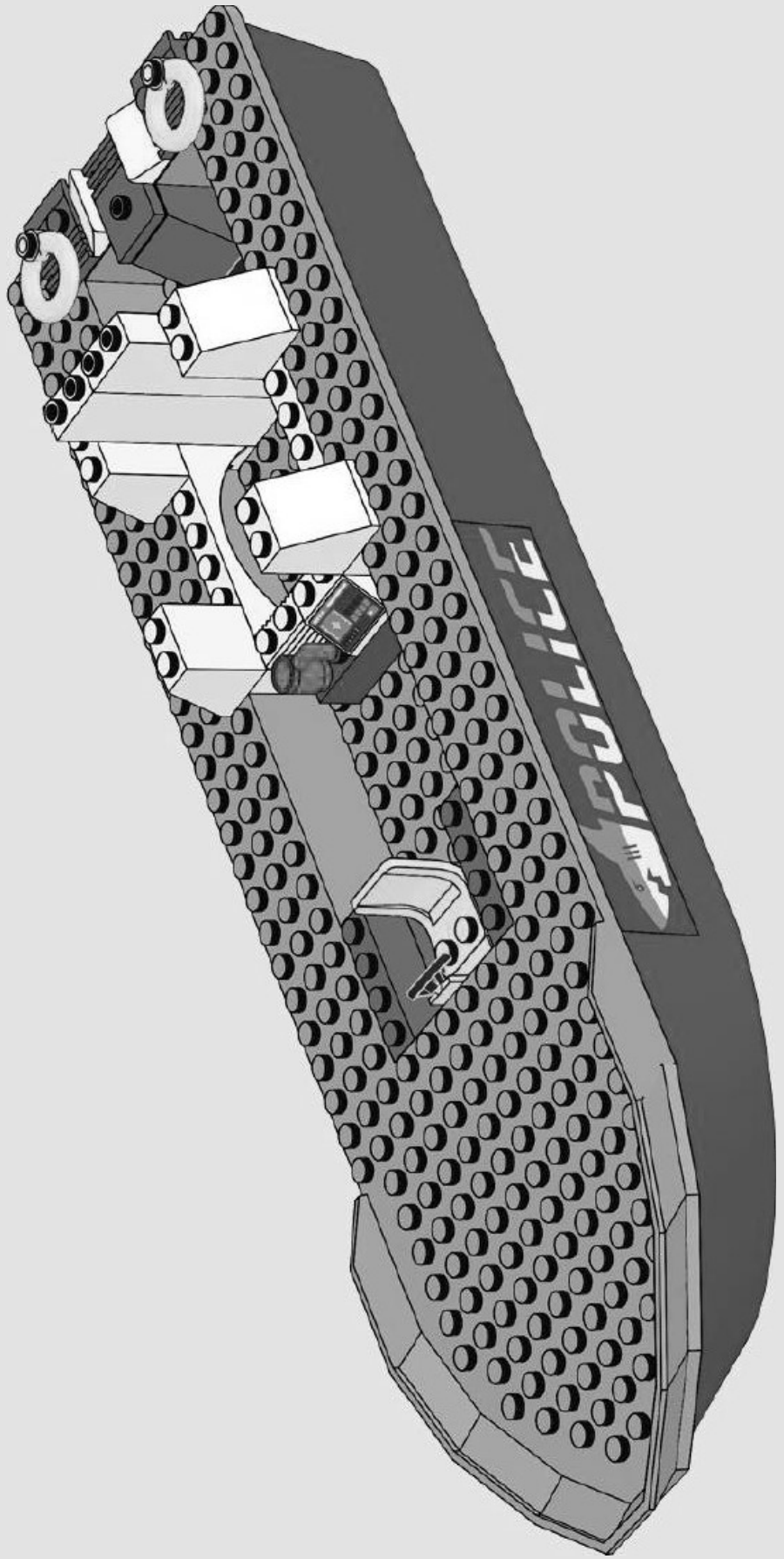

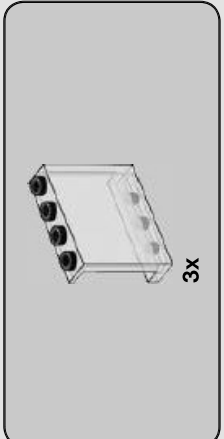

15

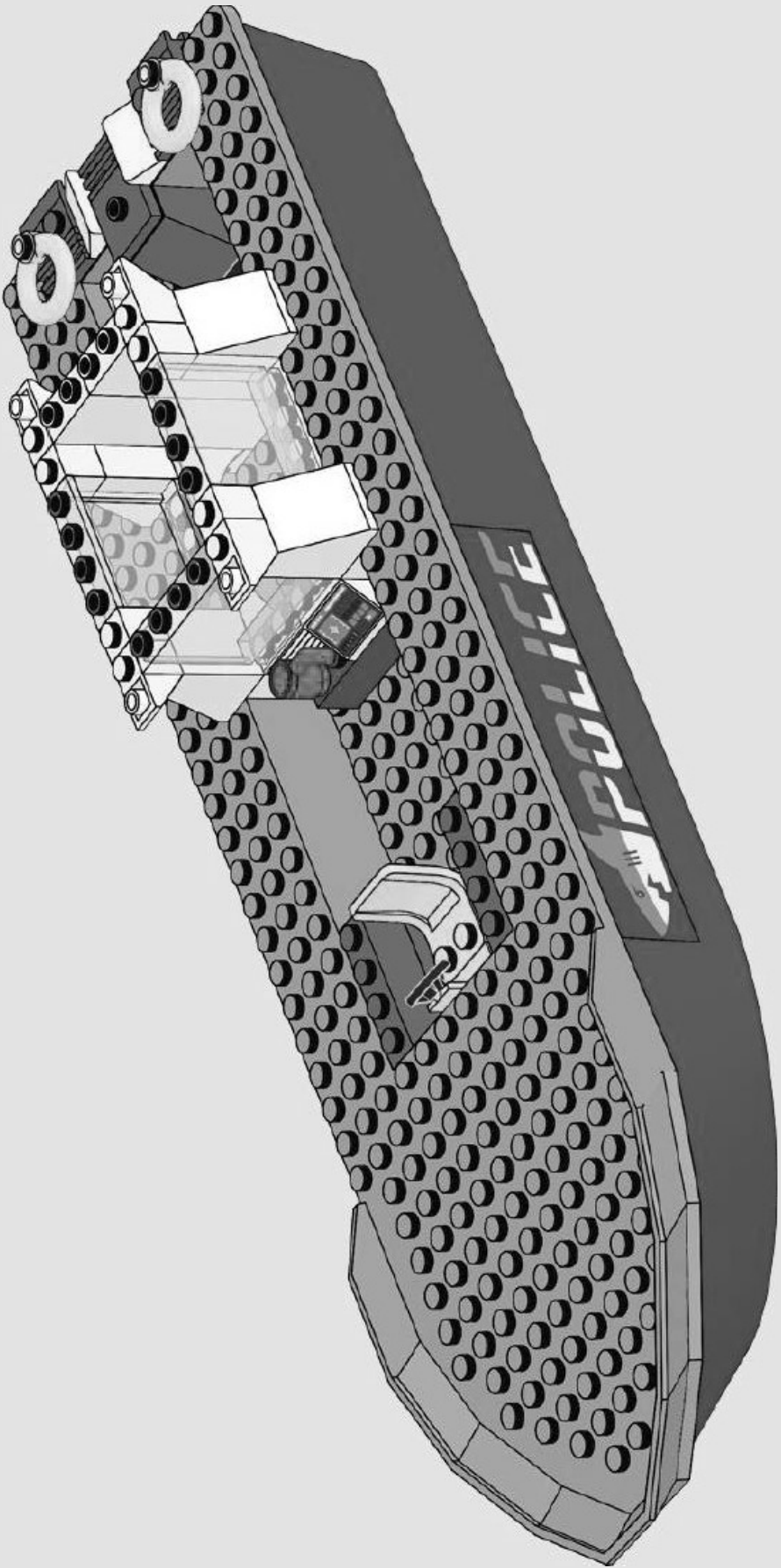

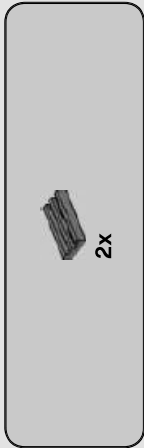
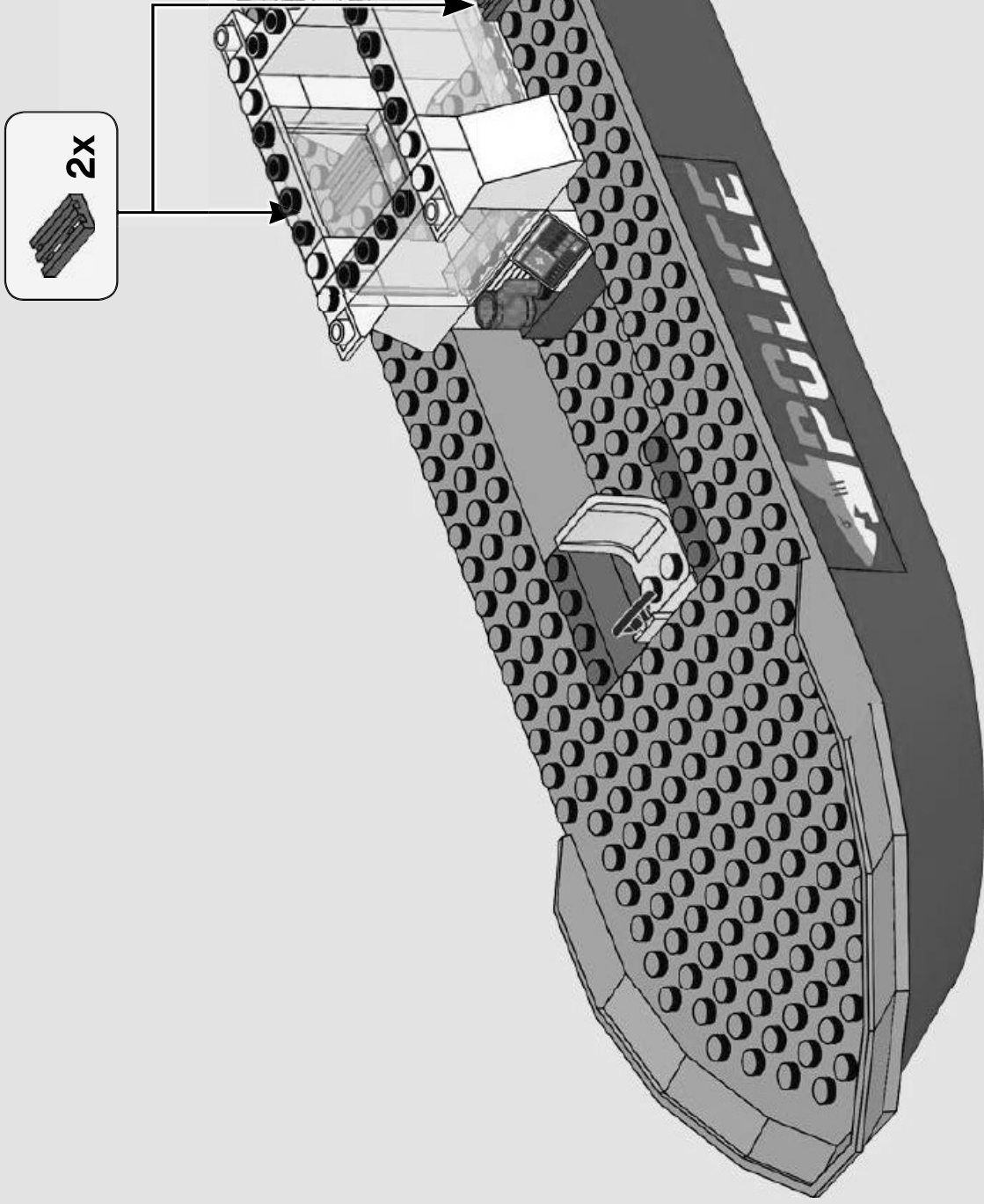

16



17

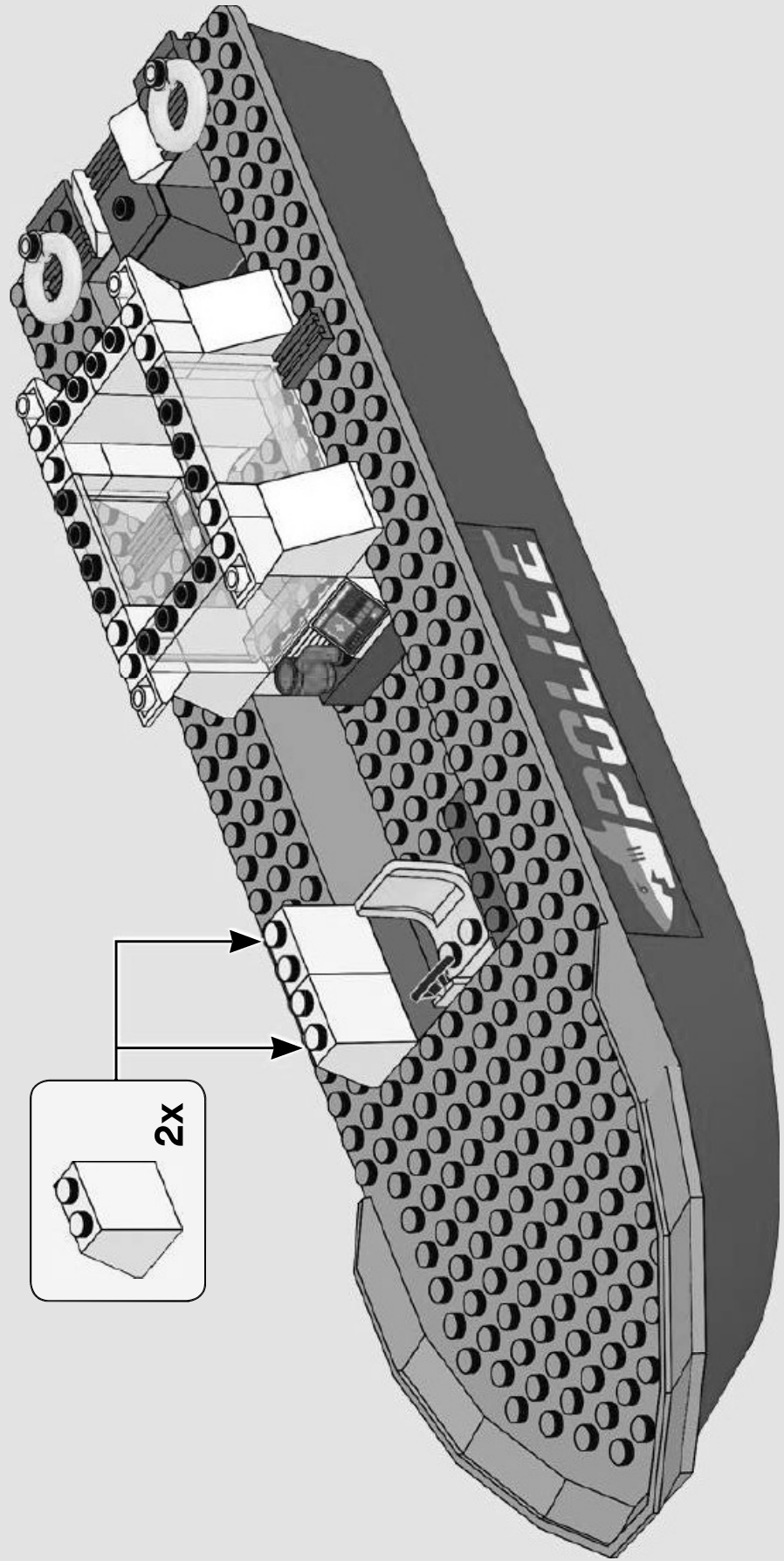

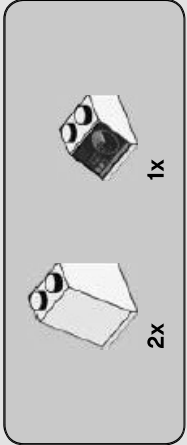

18

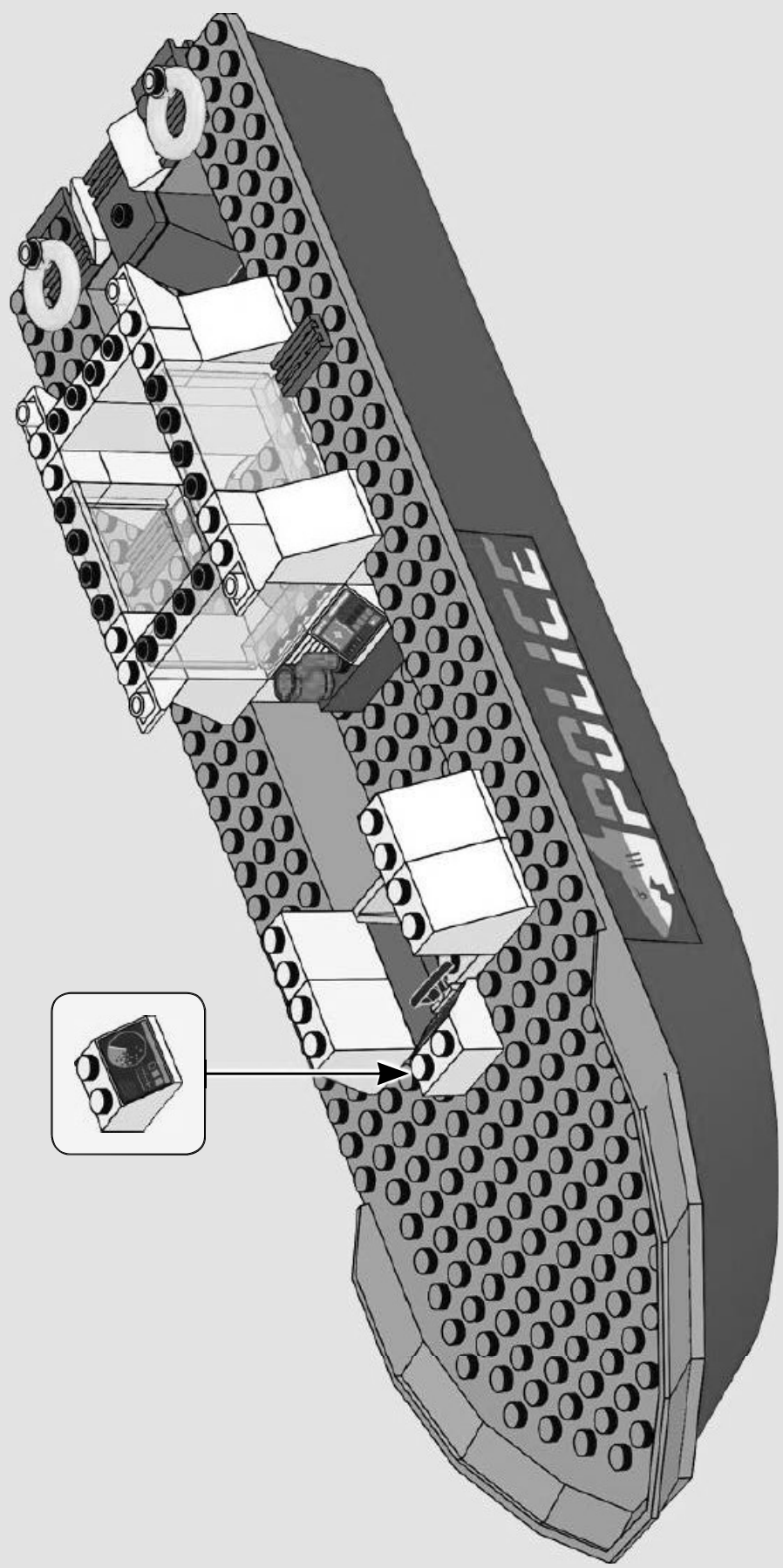



19

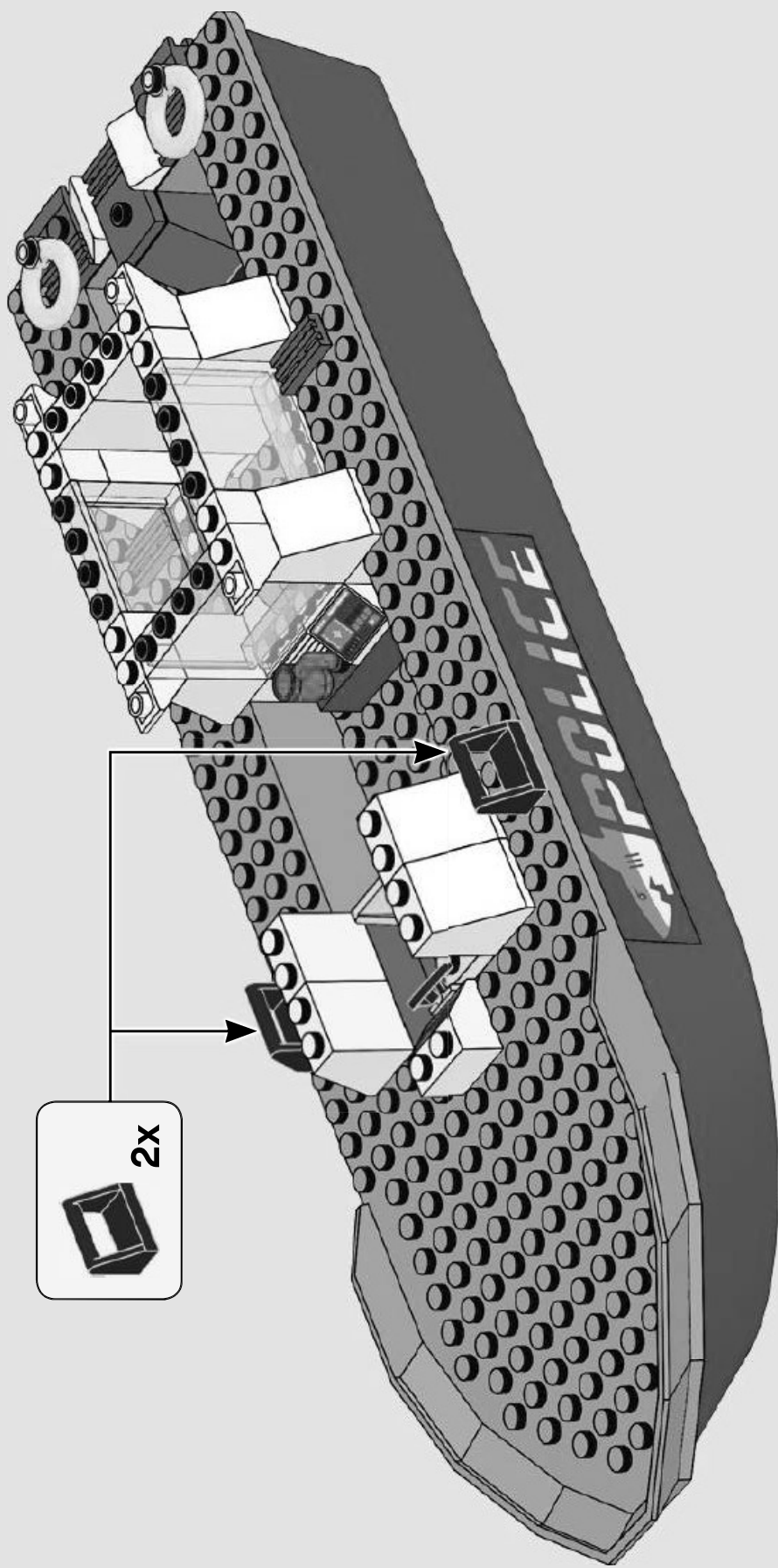



20

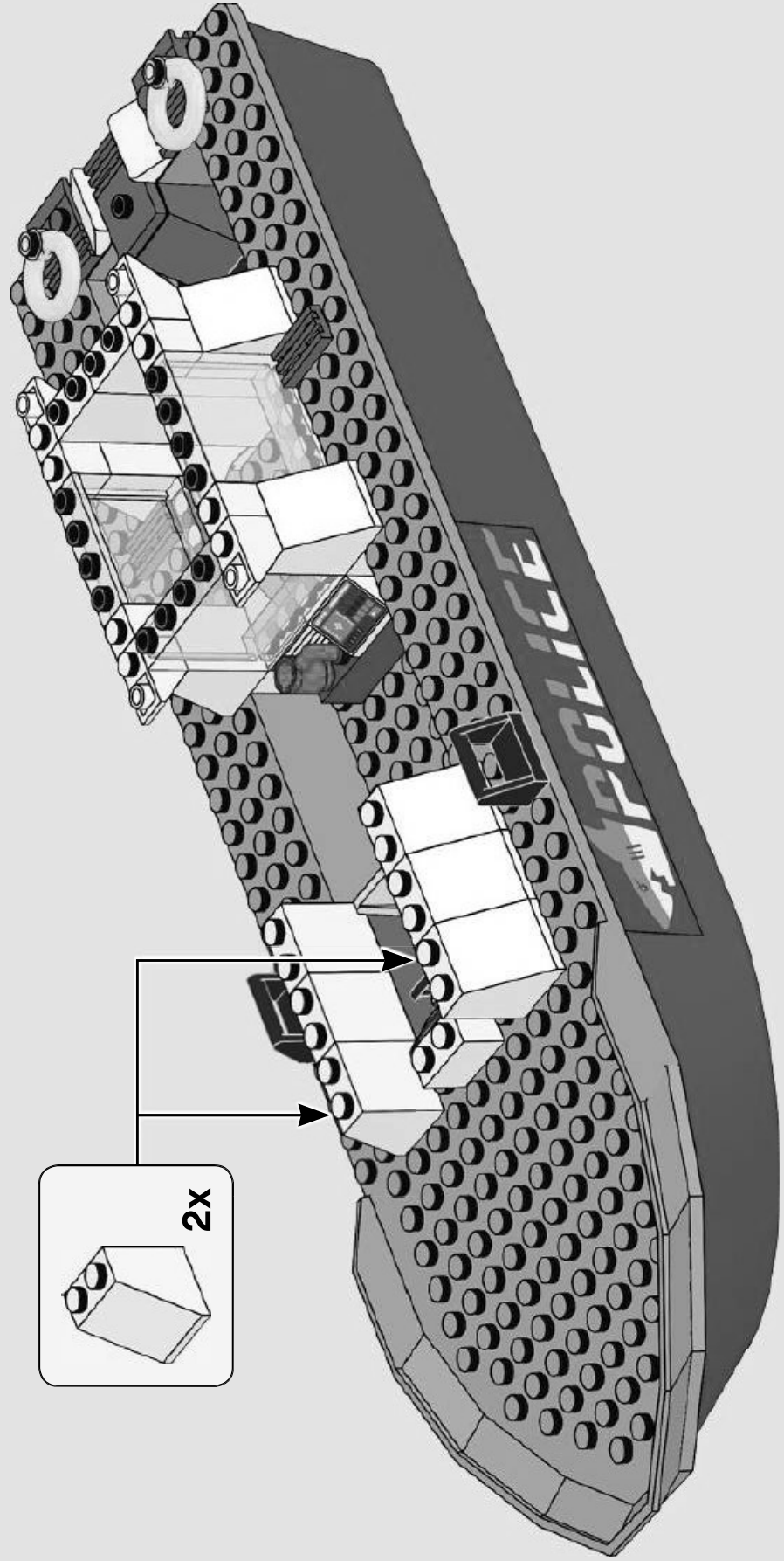



21

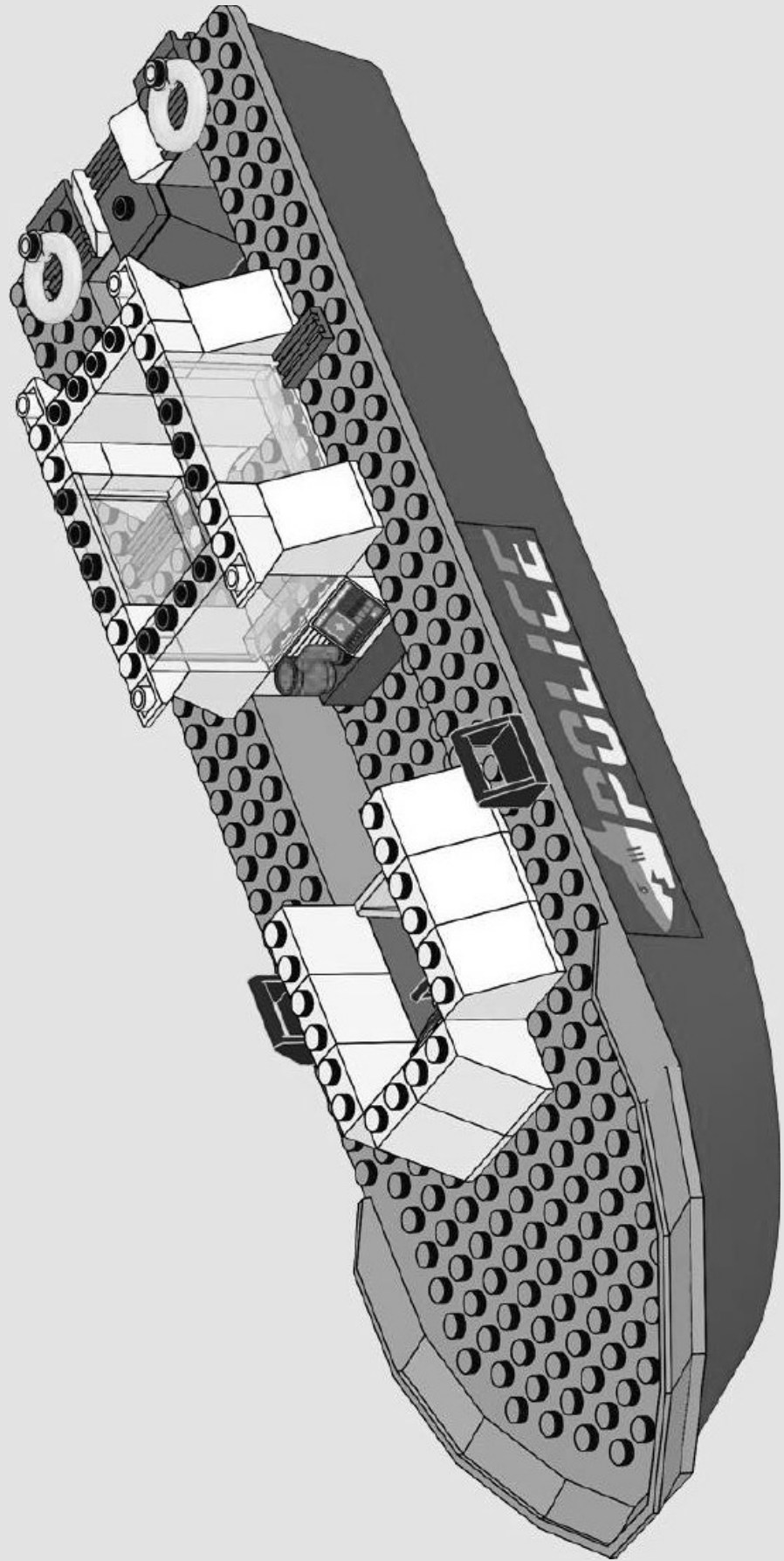



22

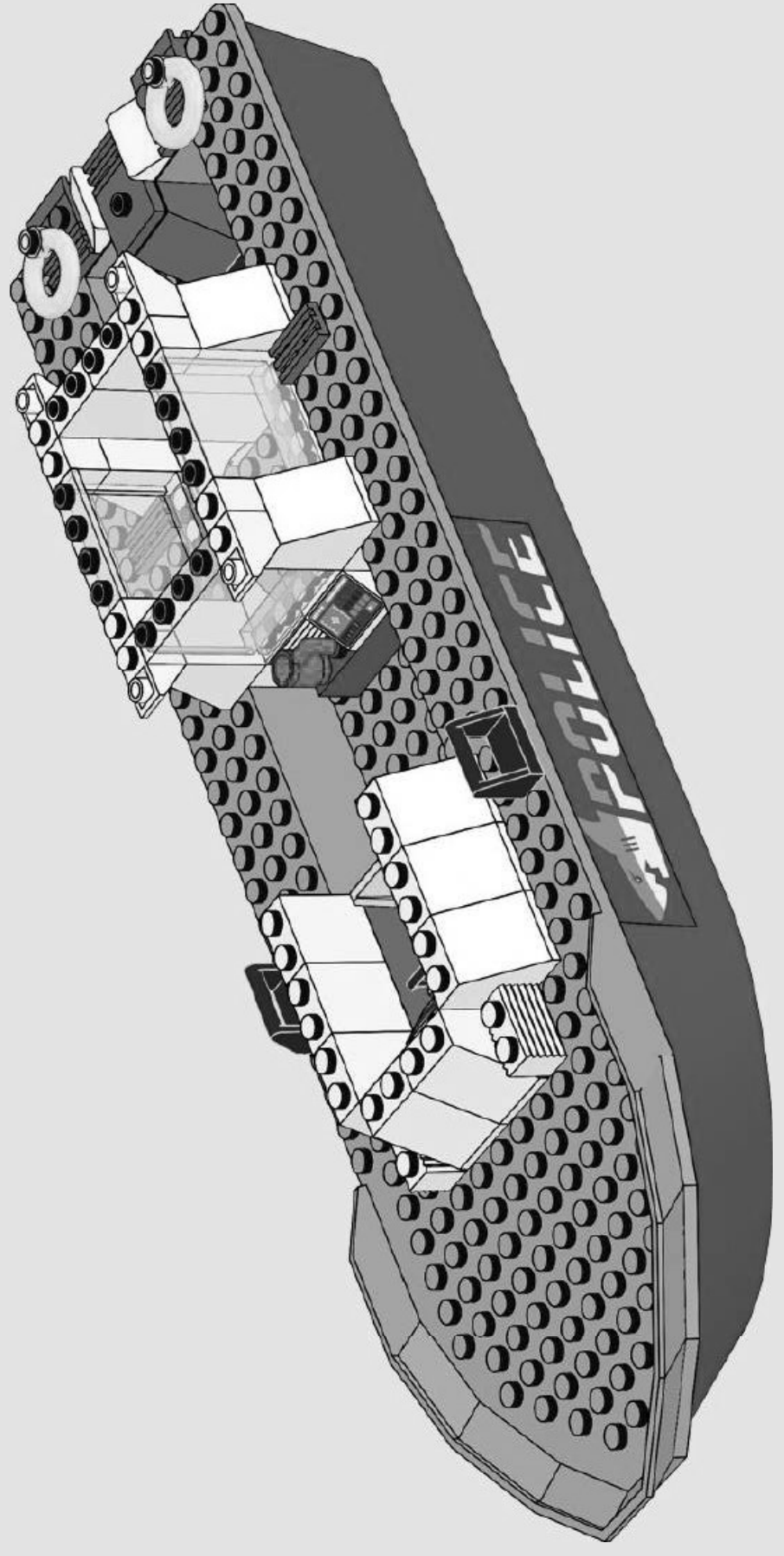

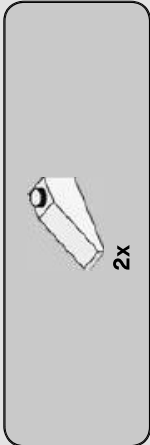

23

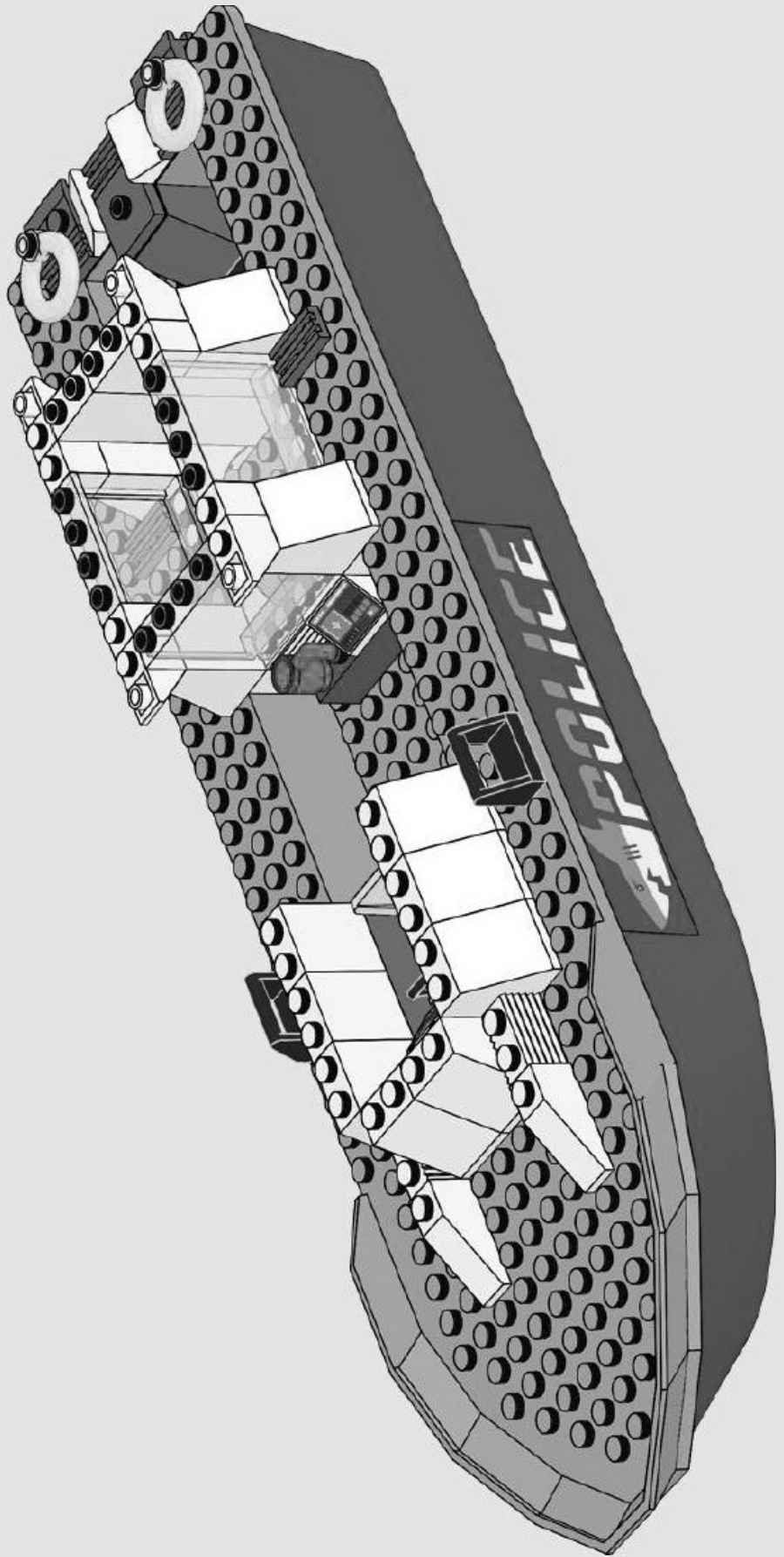



24

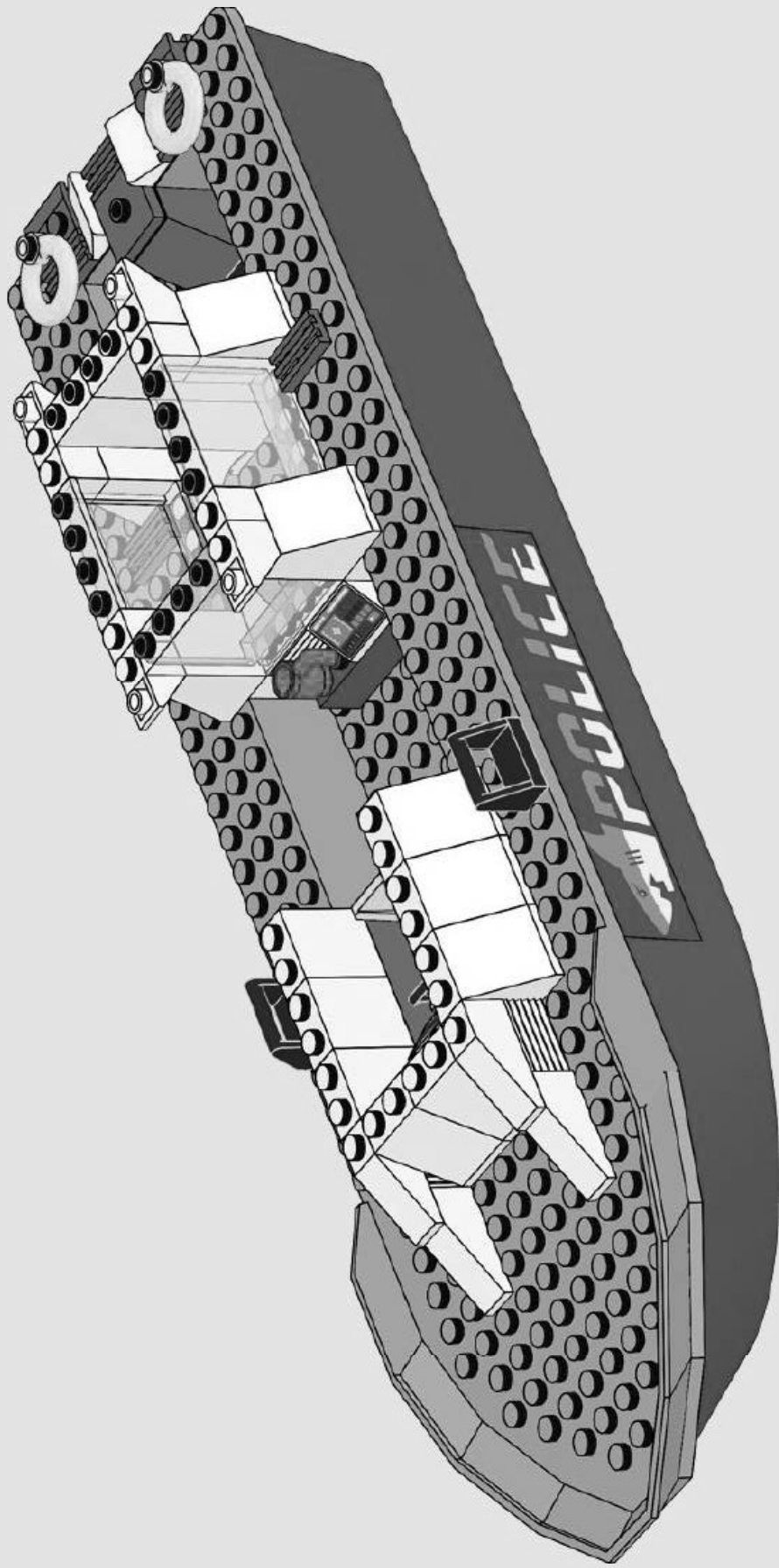

 2x

25

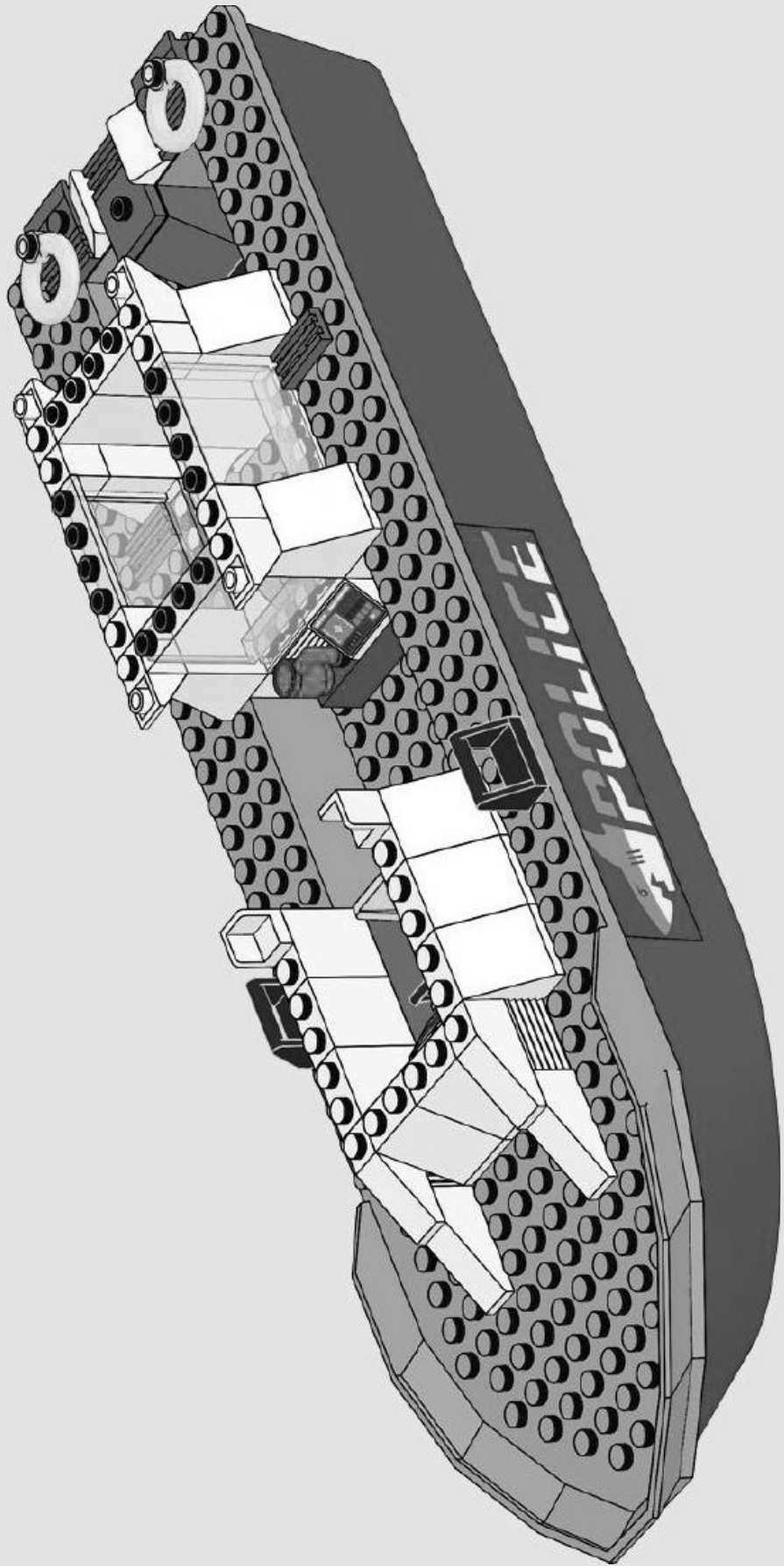

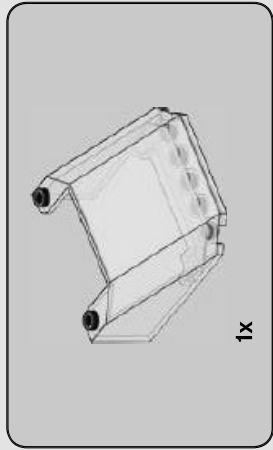

26

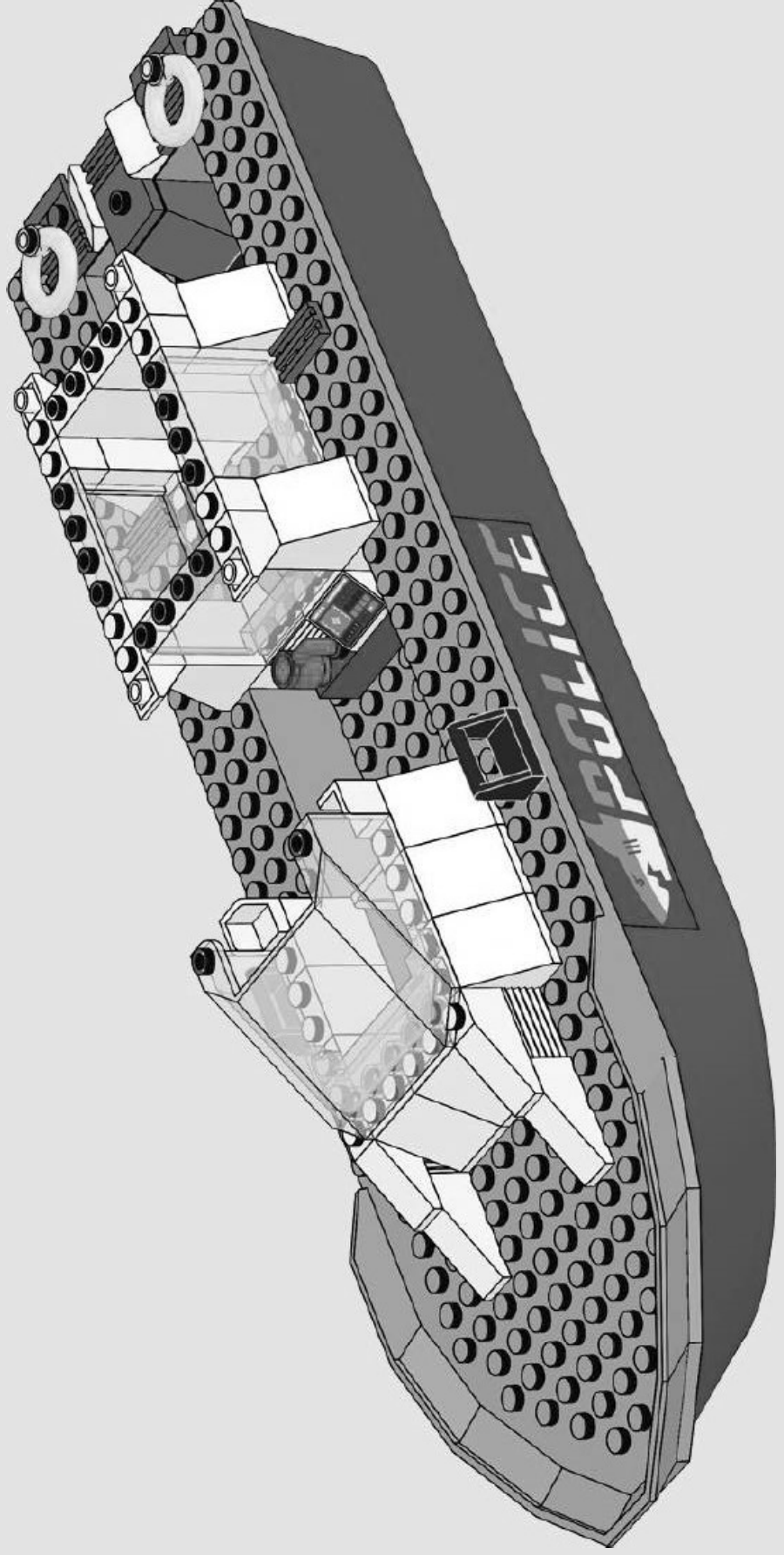

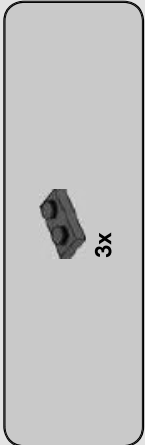

27

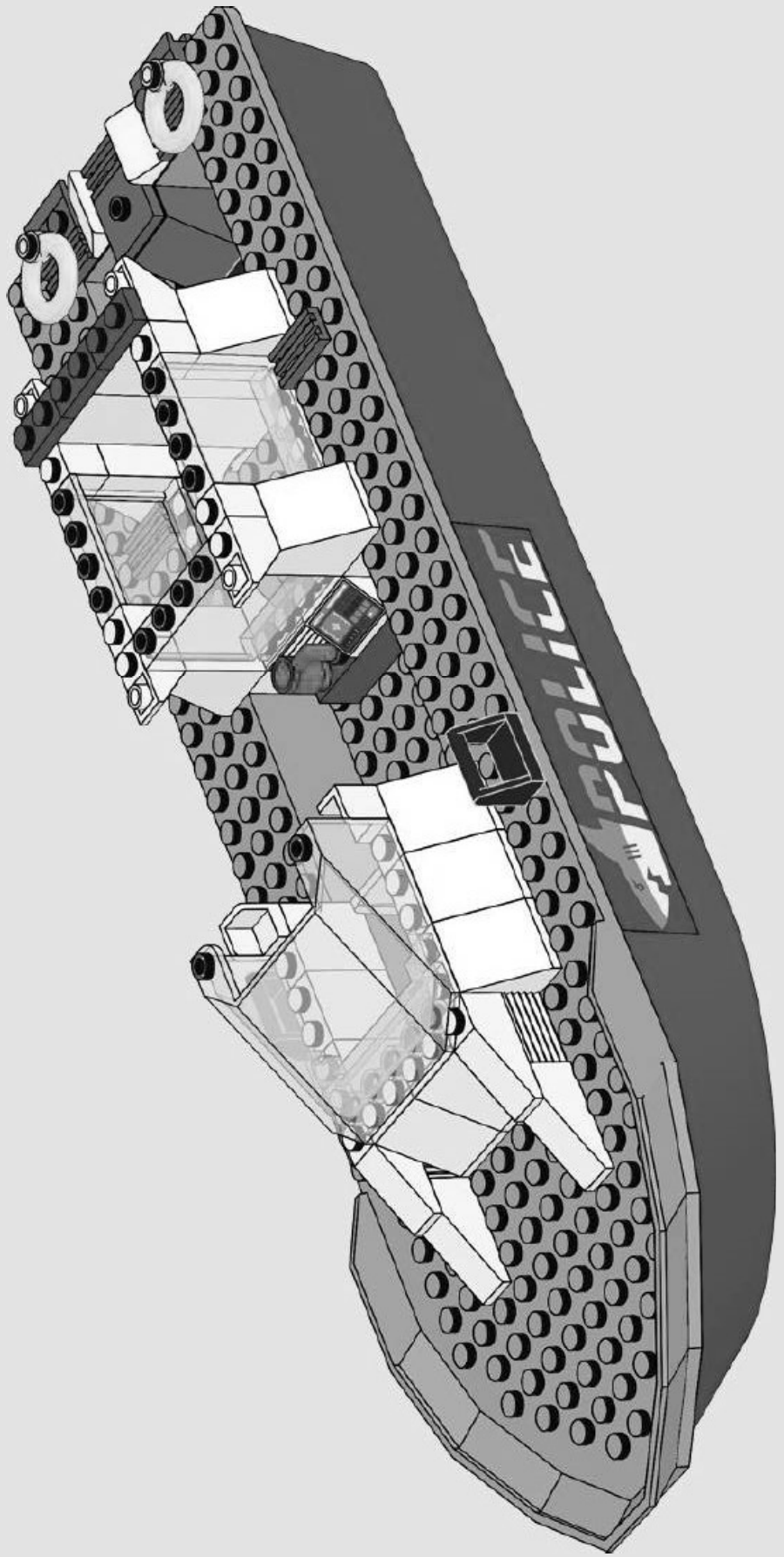

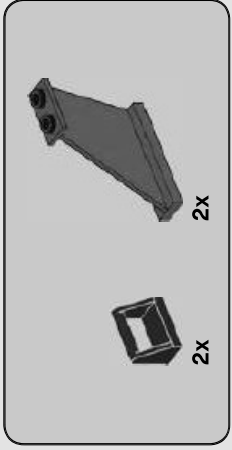

28

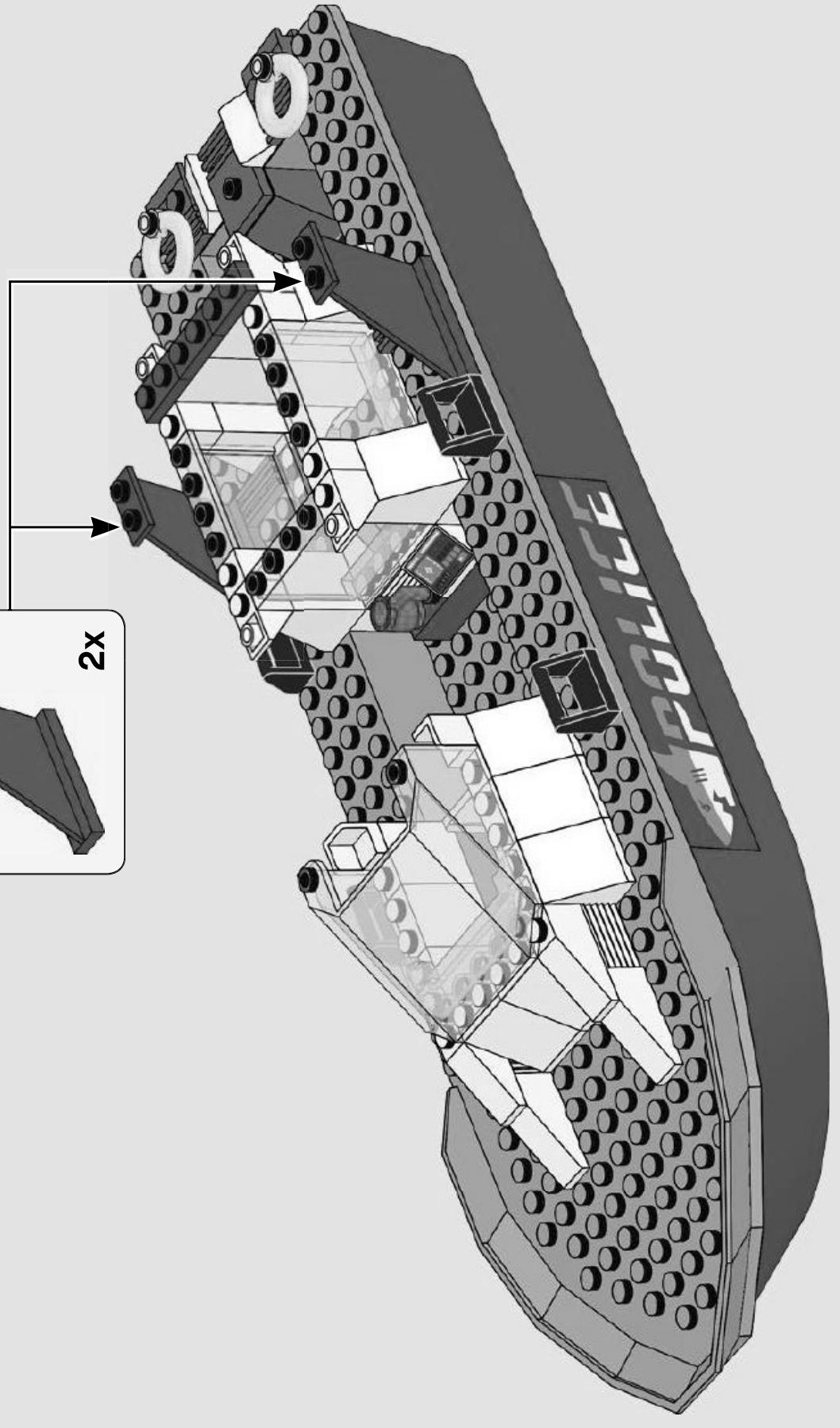
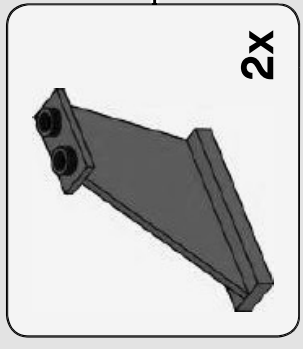



29

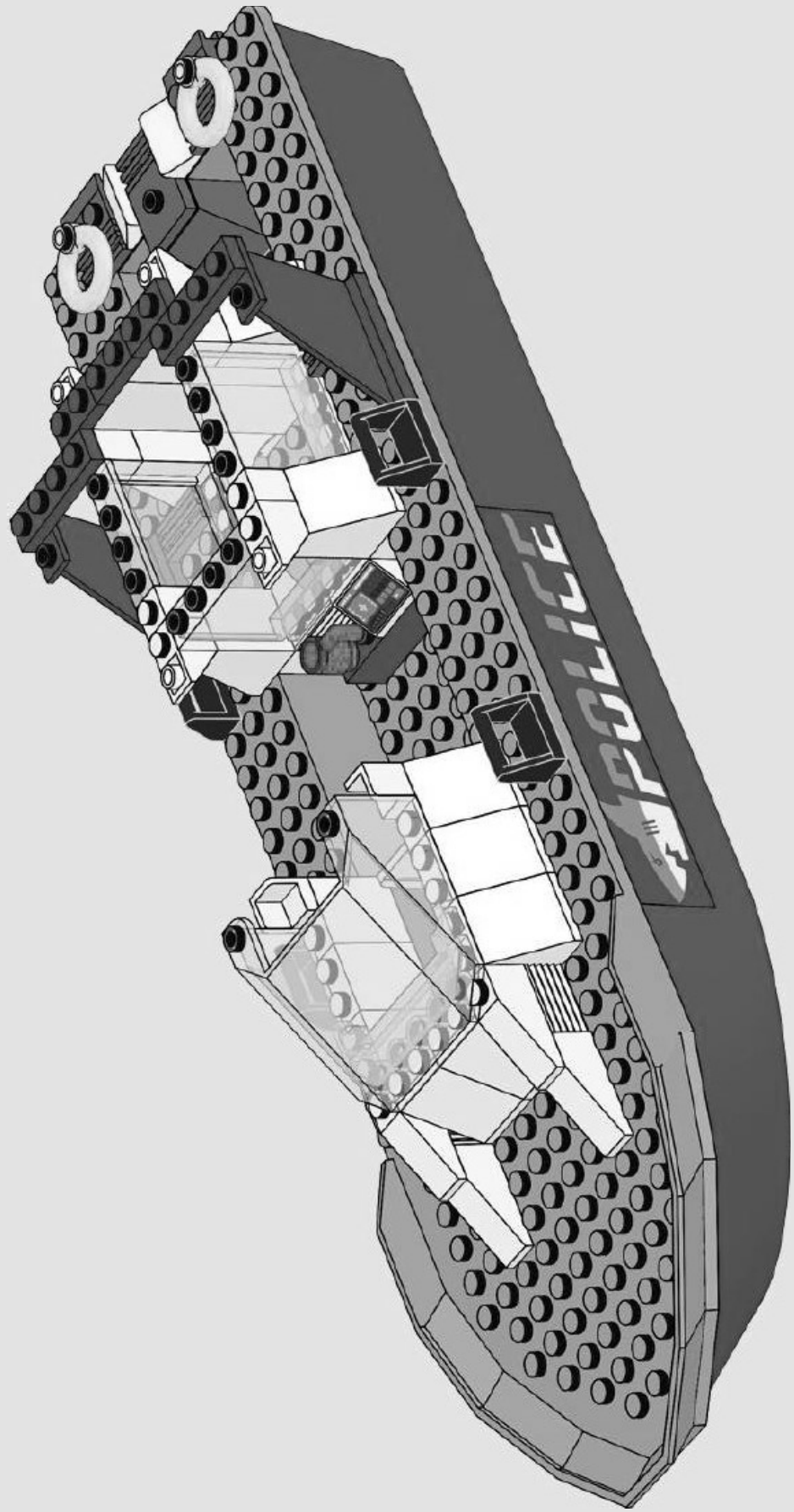

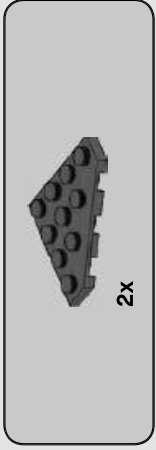

30

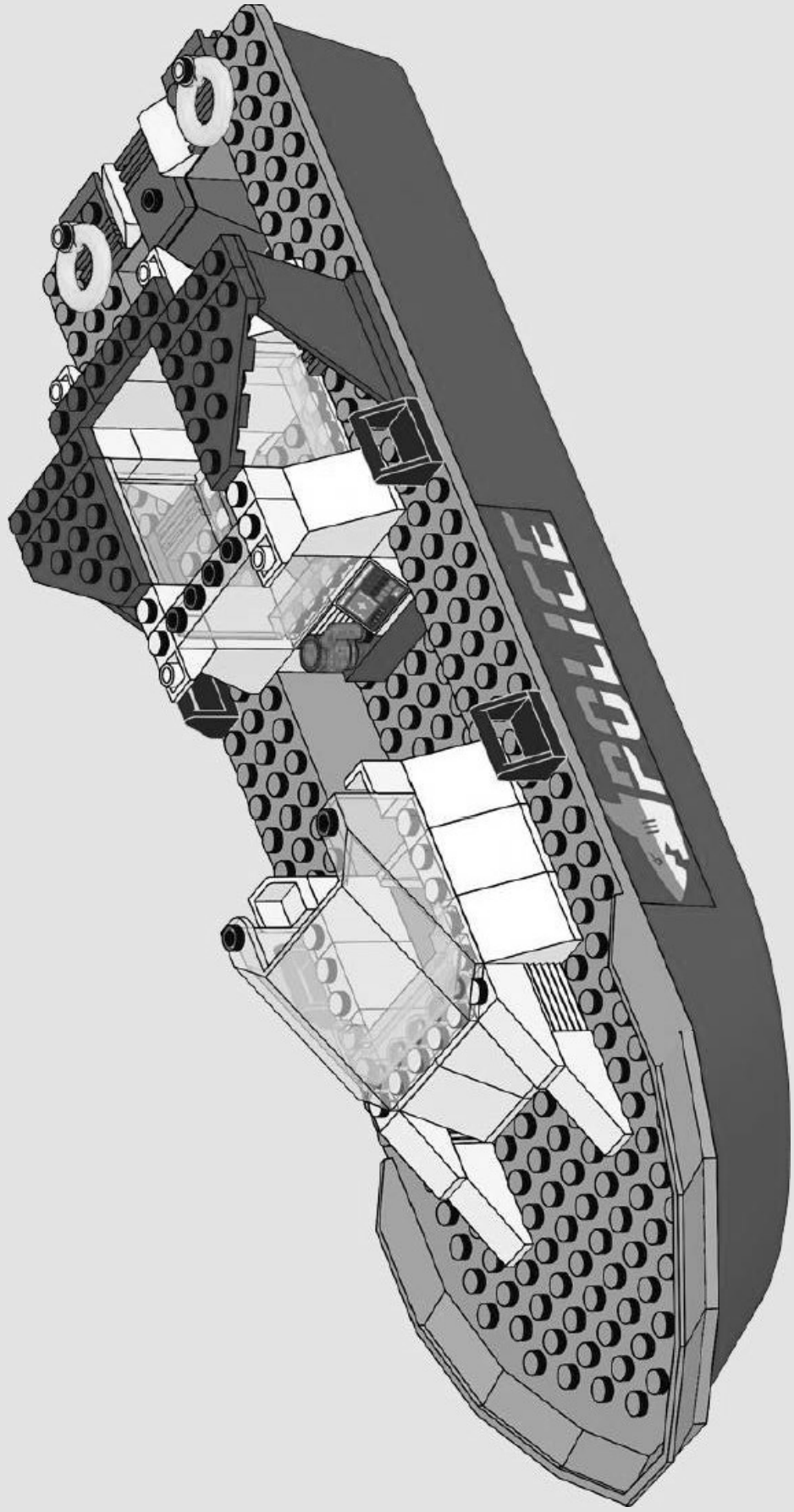

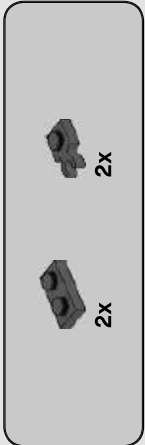

31

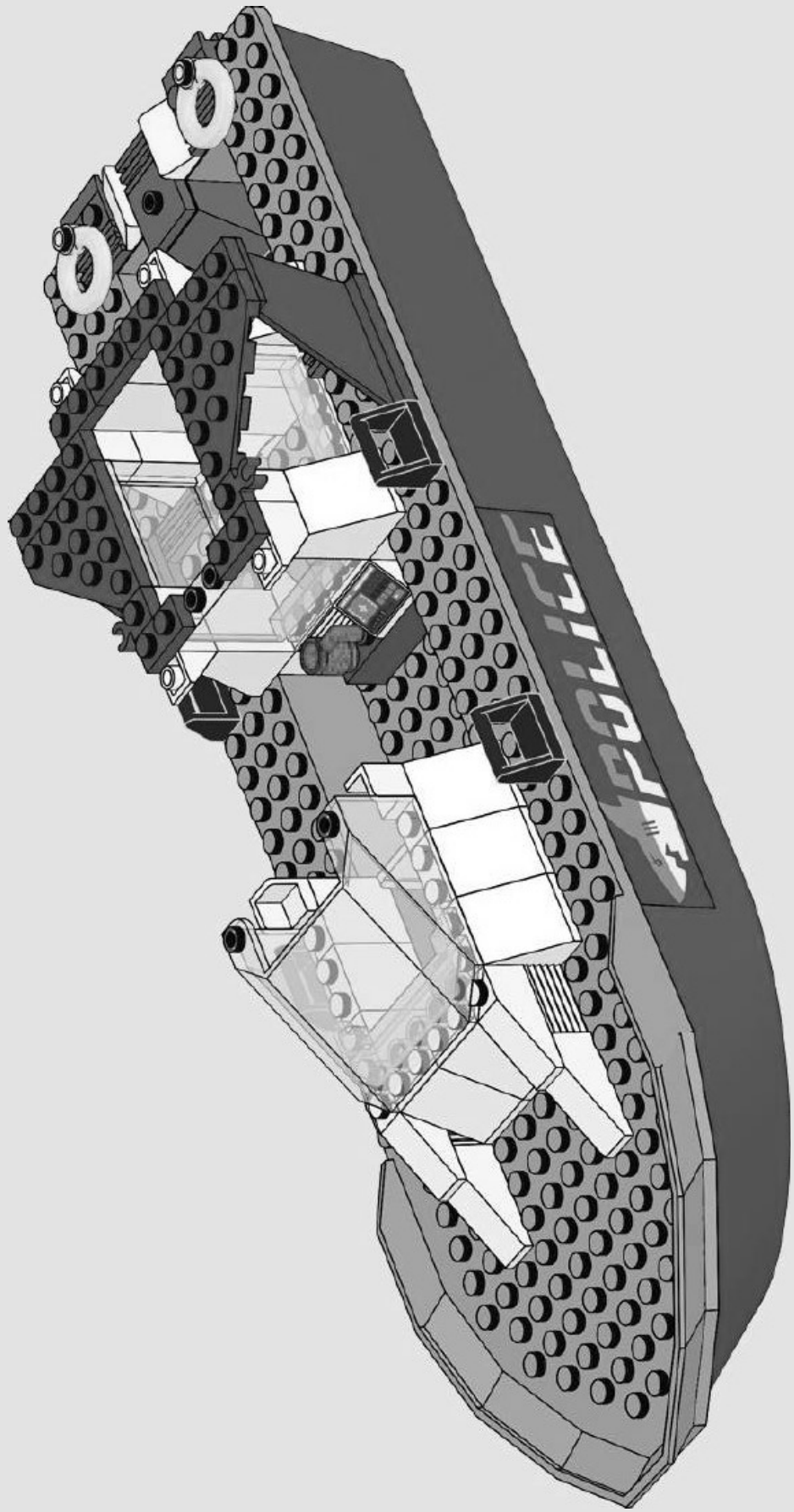

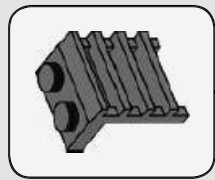
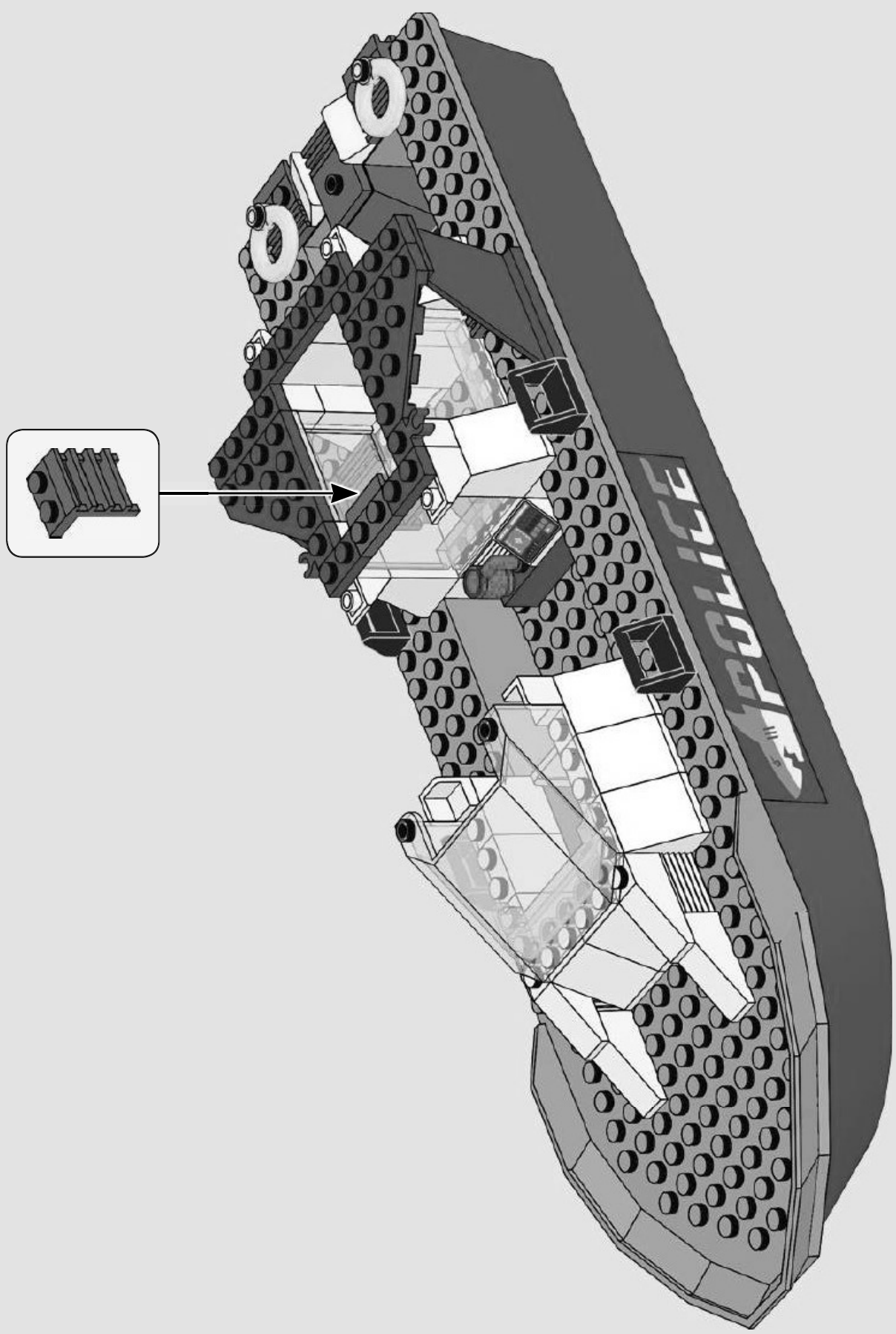

32

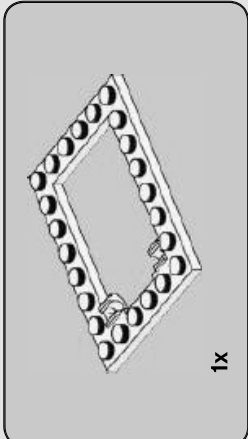
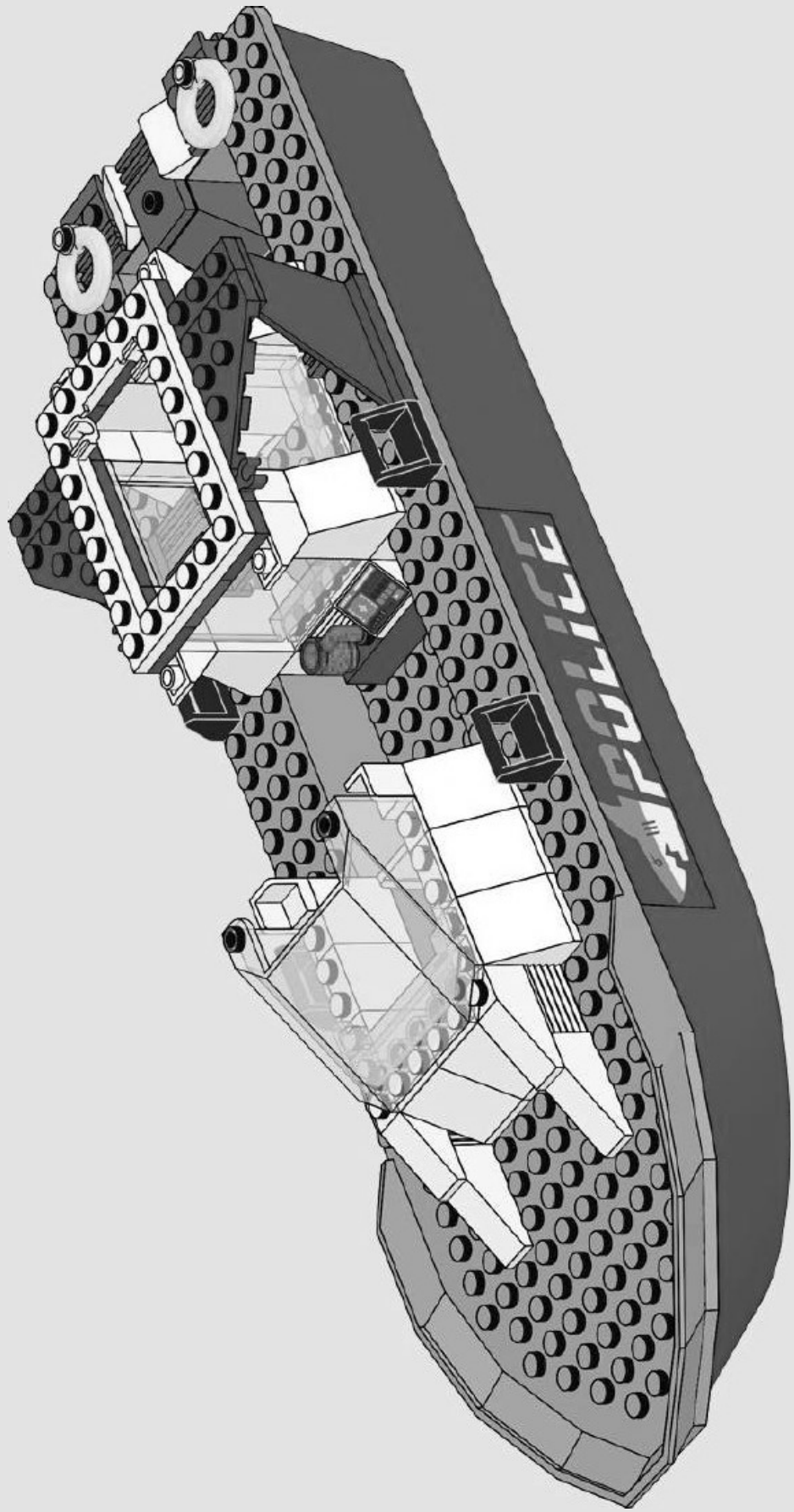

1x

33

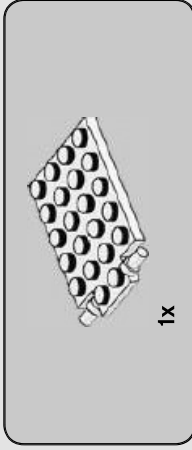
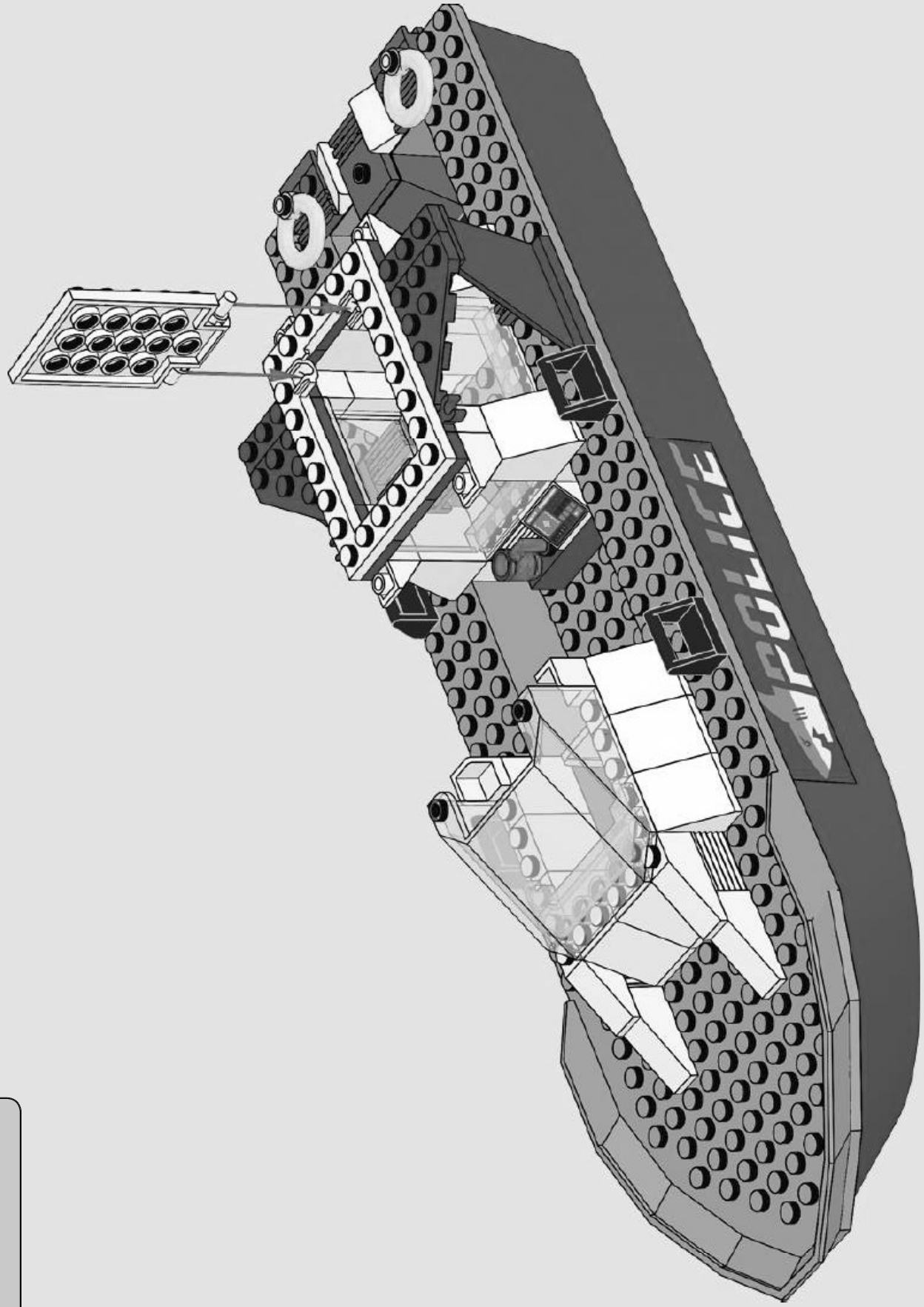

34

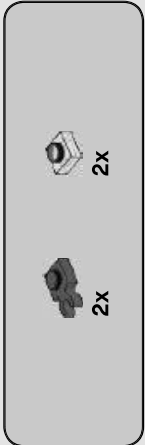

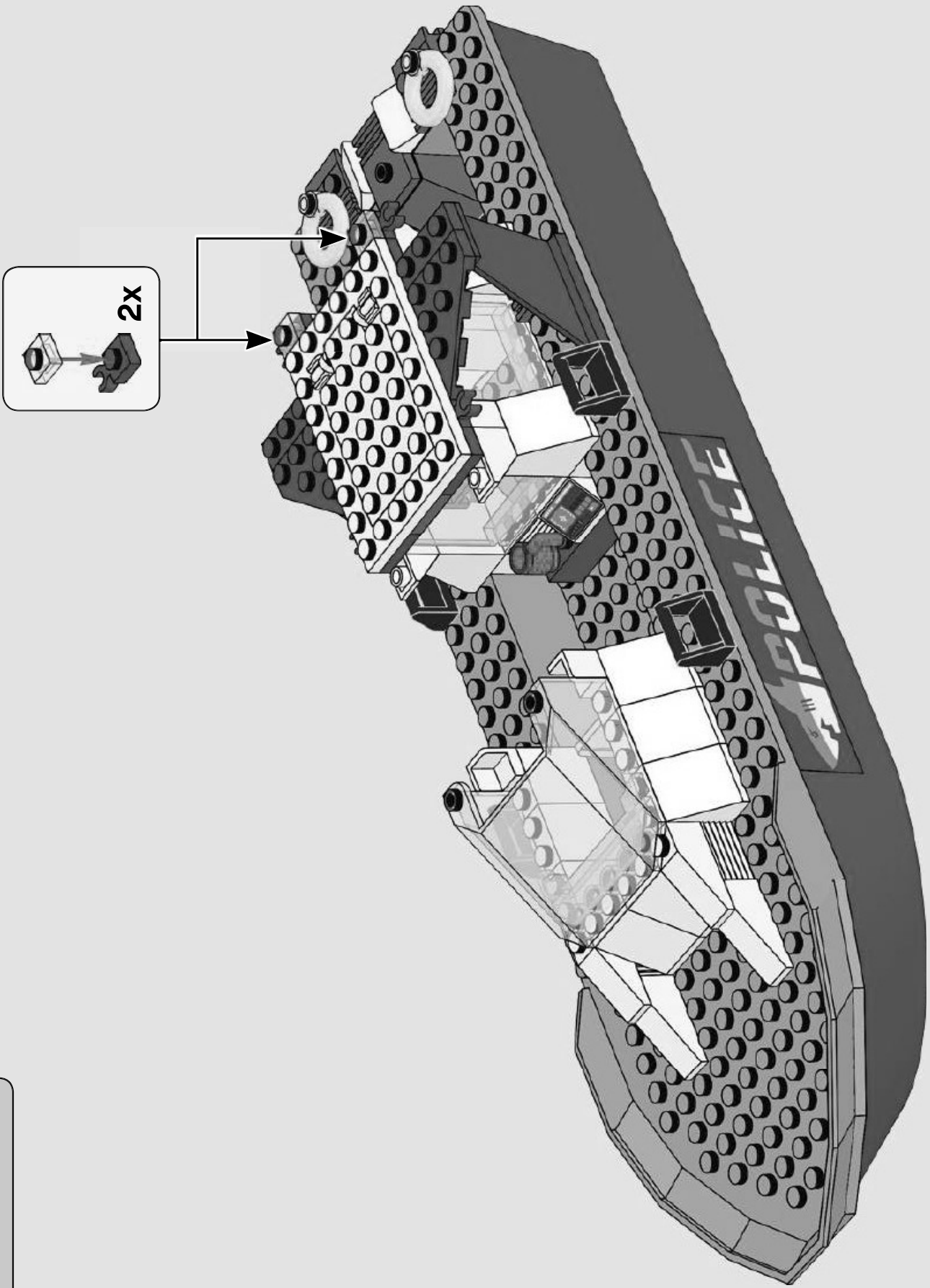

35



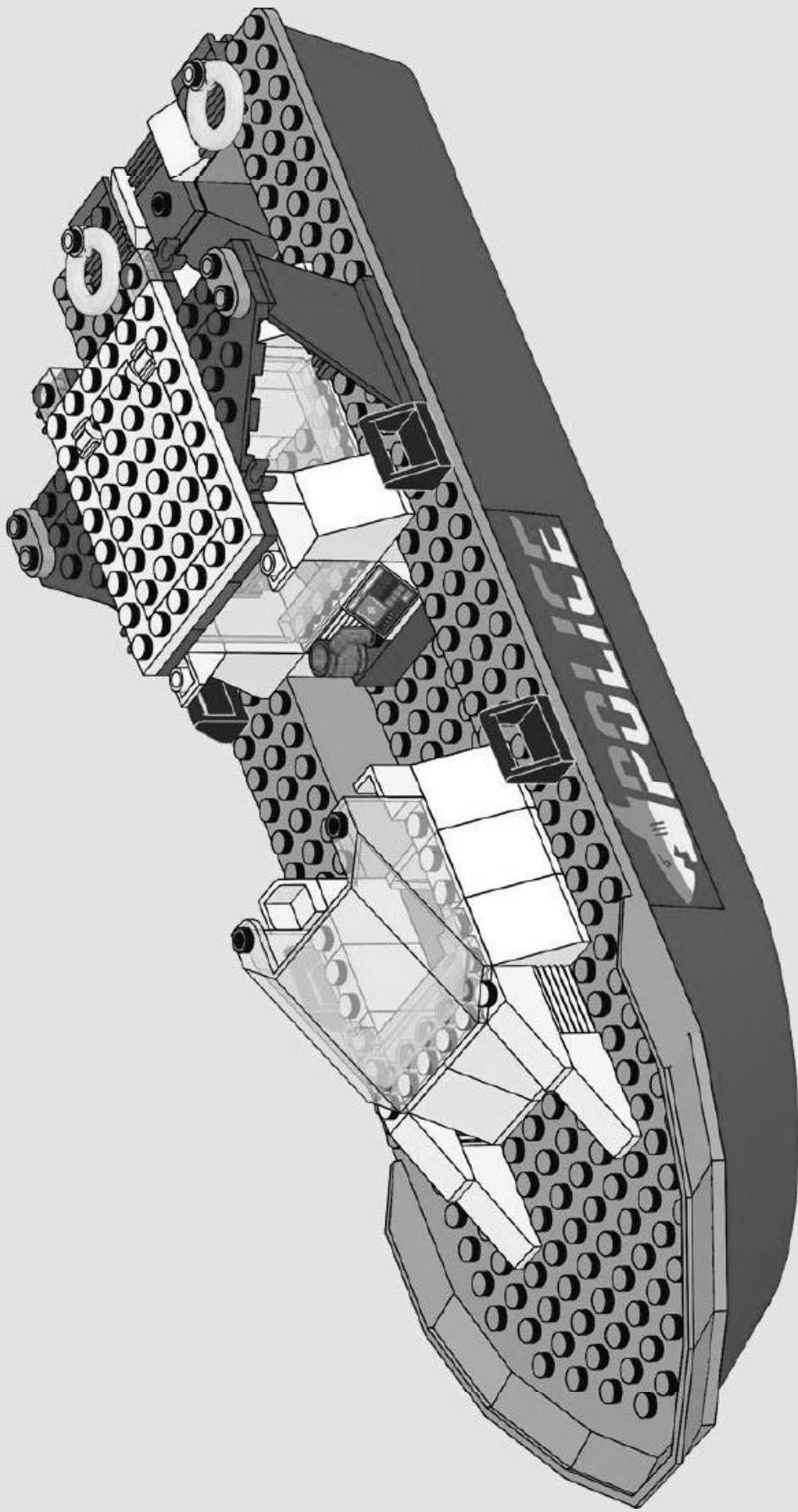

36



 1x
 1x



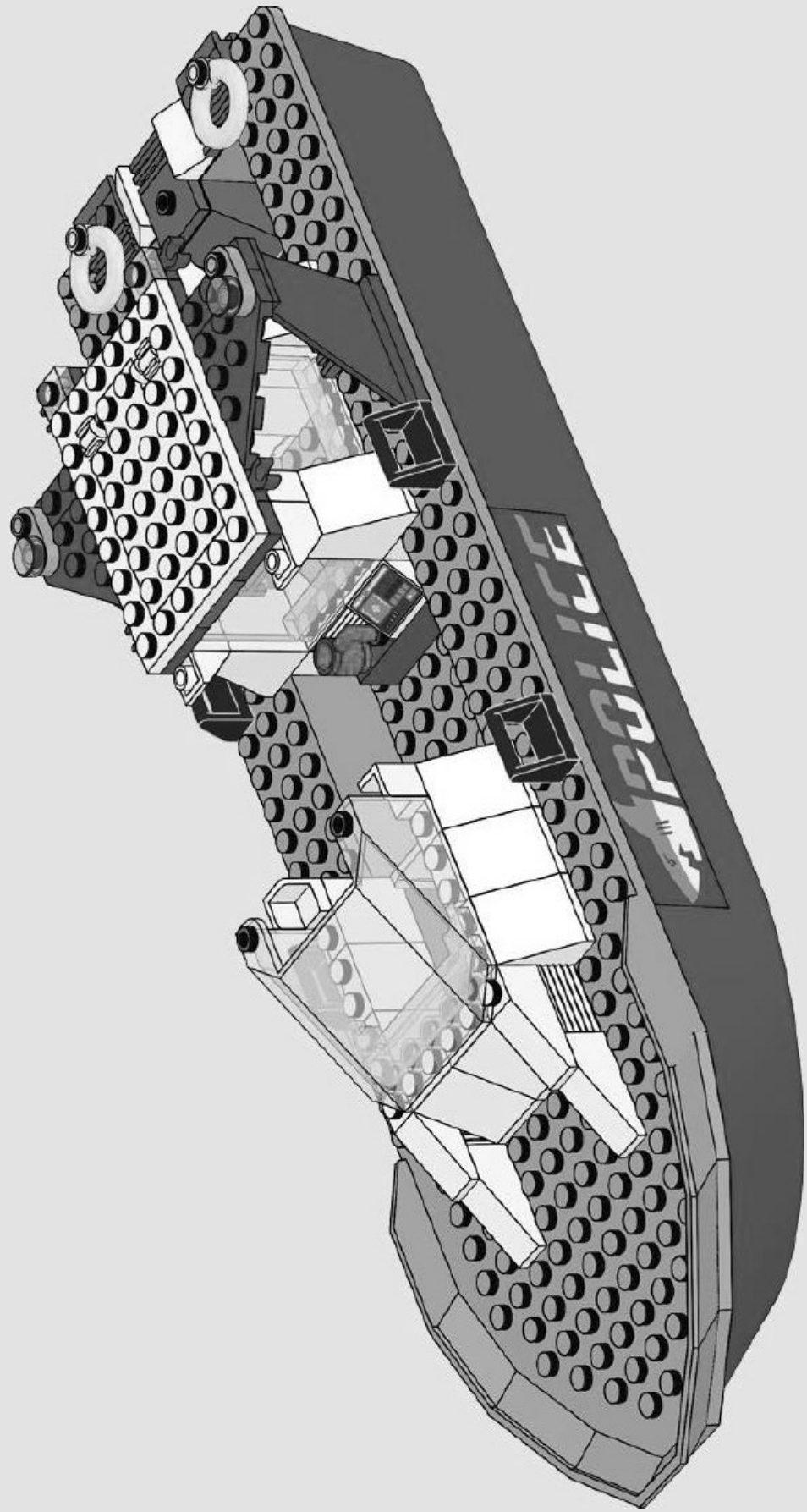

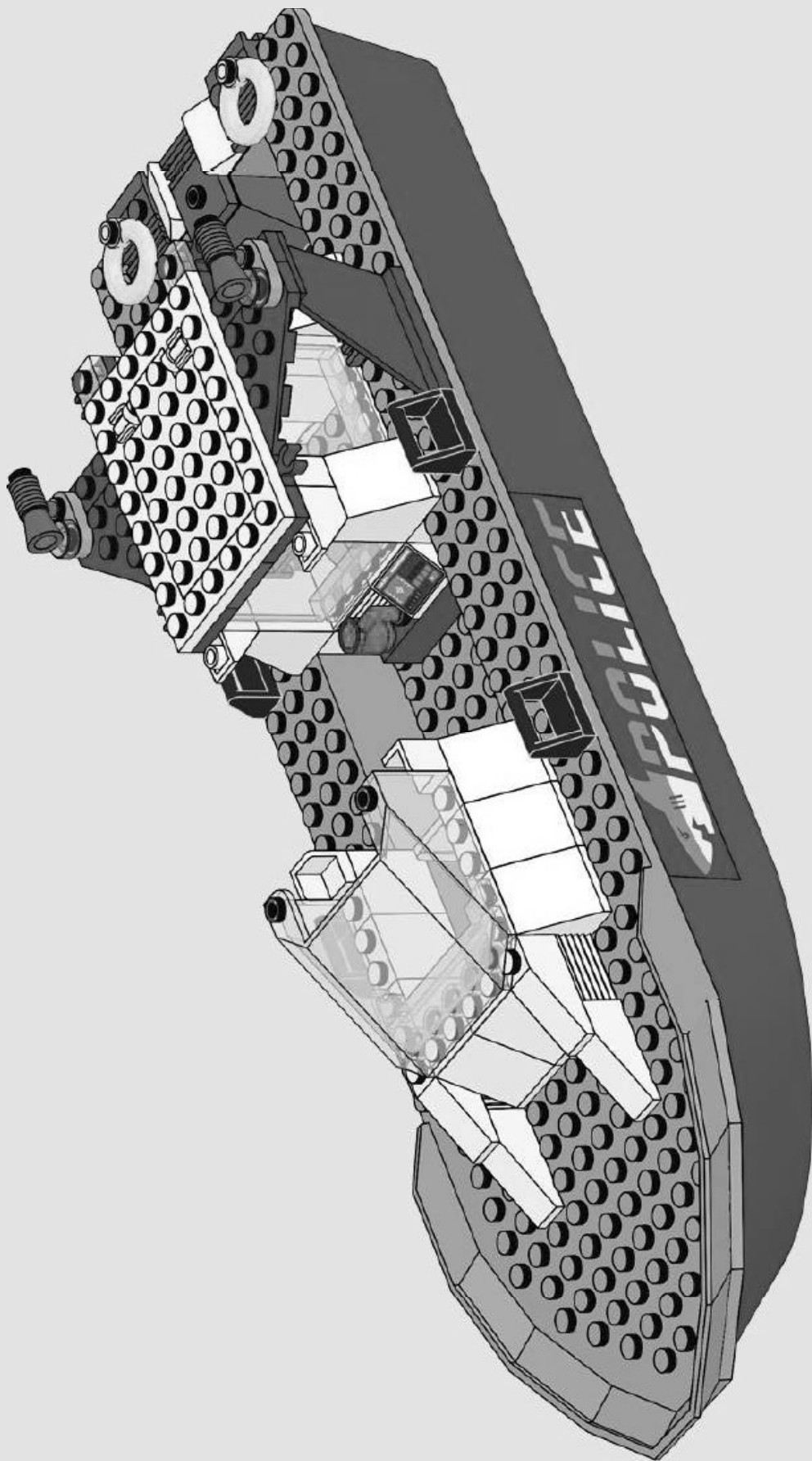
37





2x

38

-  1x
-  1x
-  2x
-  1x

39

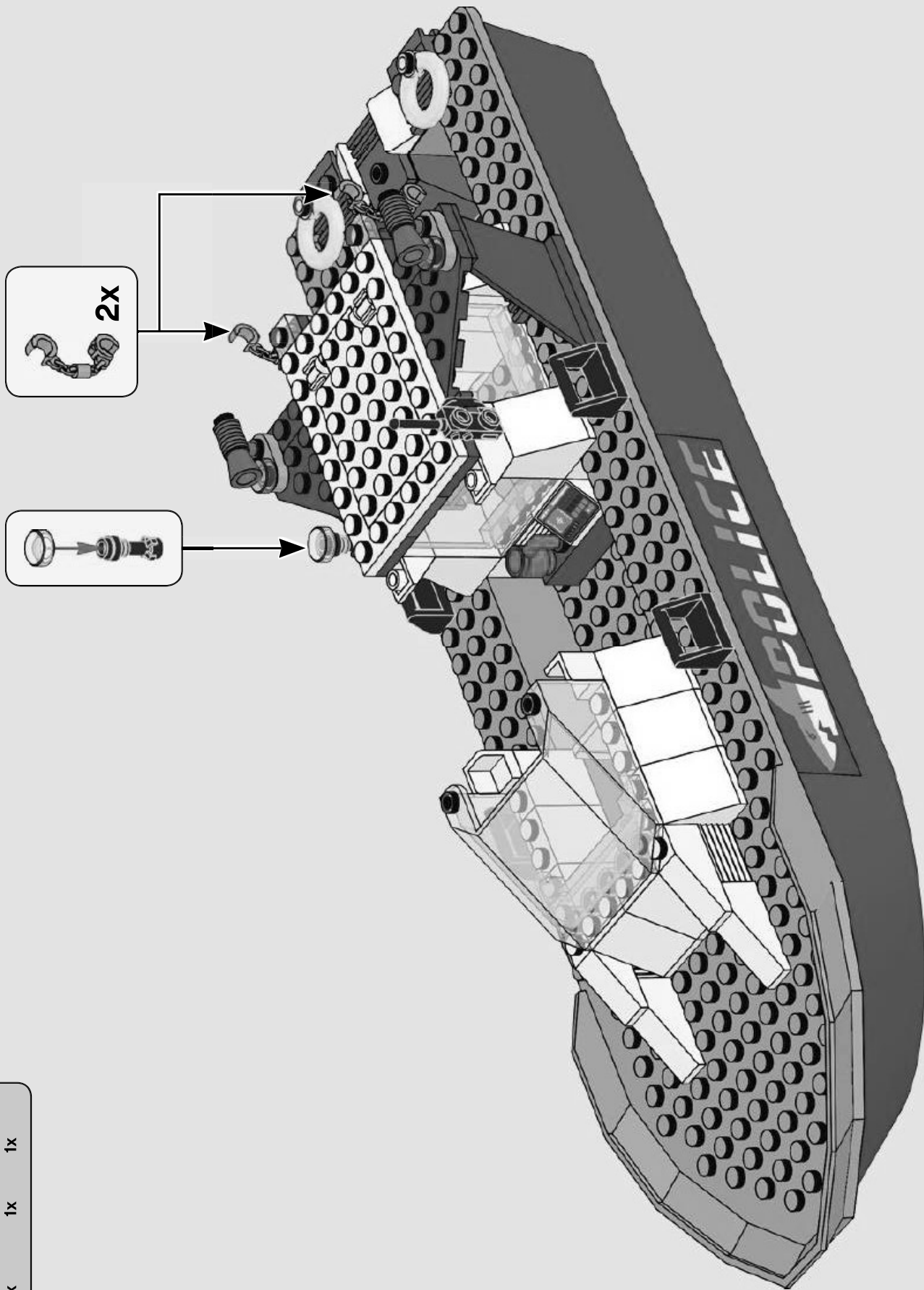

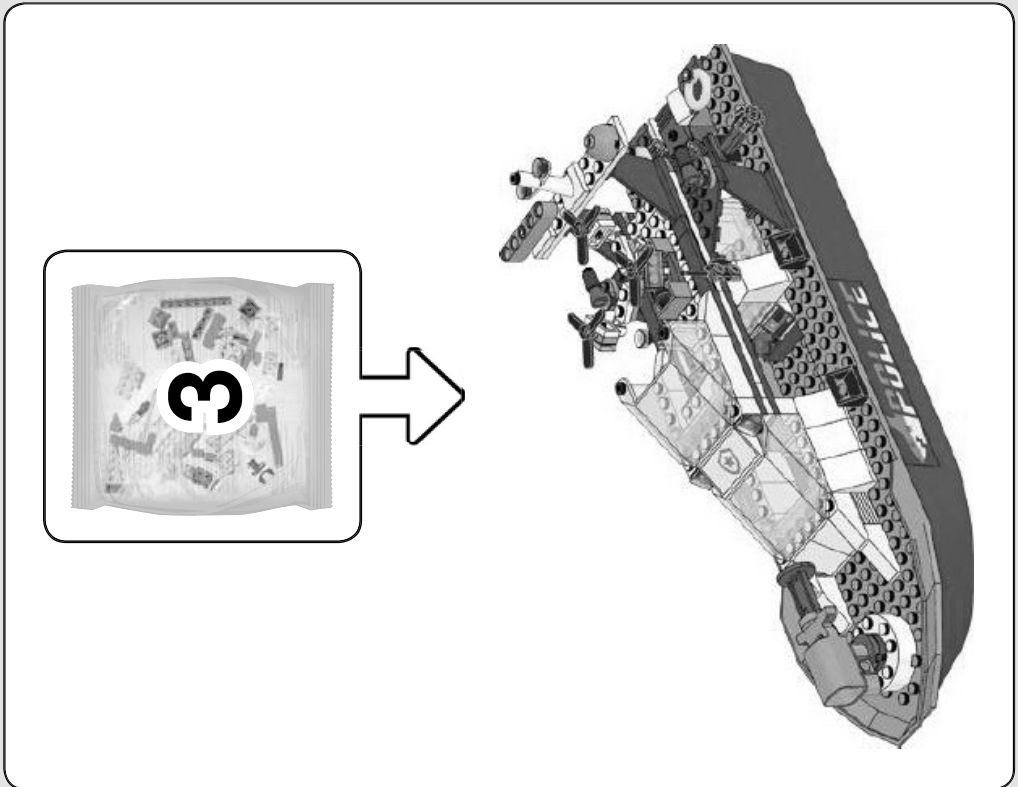

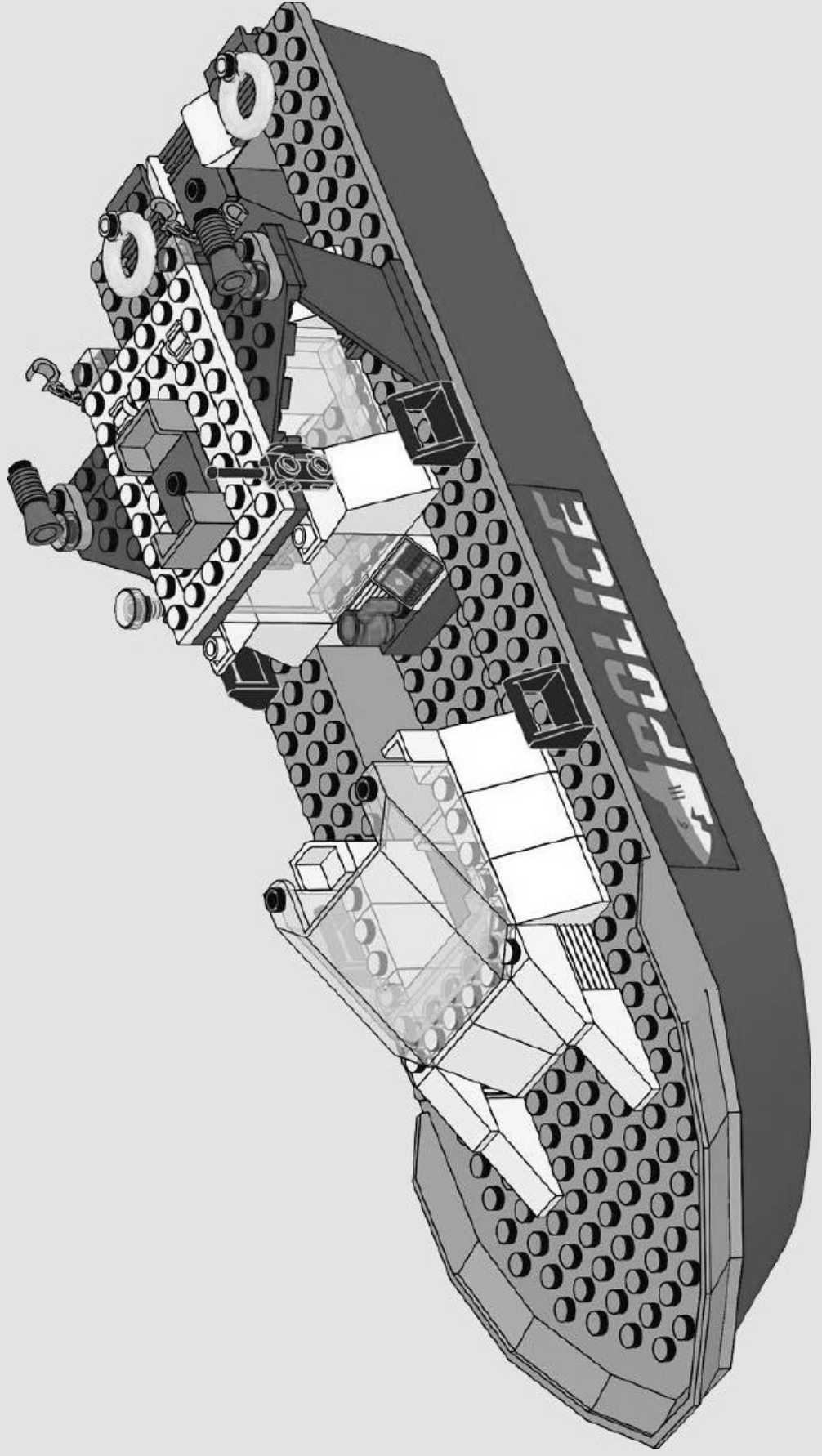

2x



1x

40

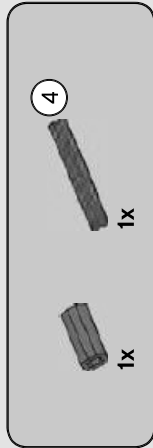
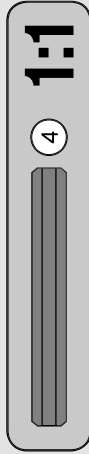
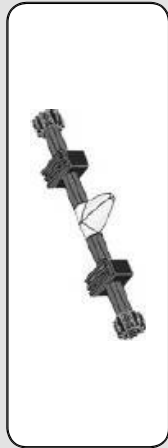

41



42



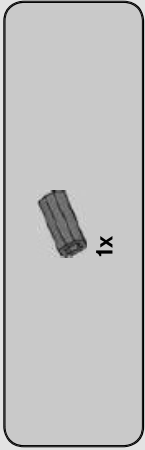

43

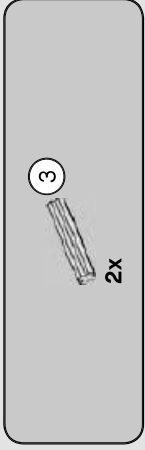

44

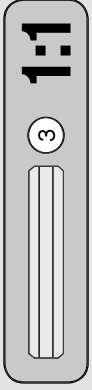

1:1

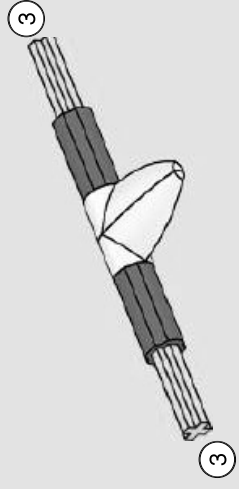

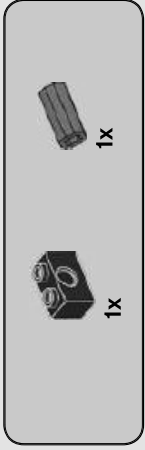

45

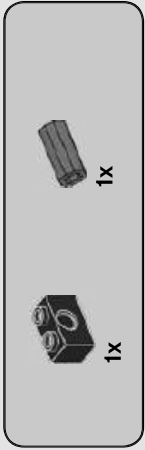
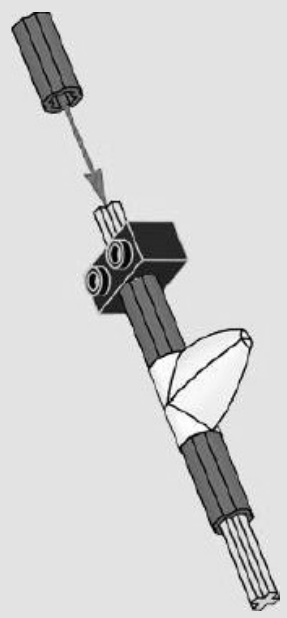

46

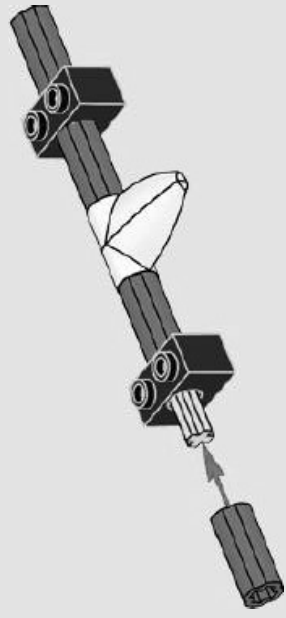

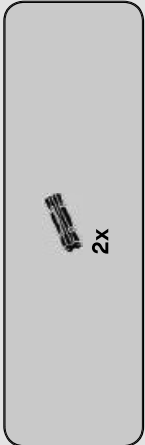

47

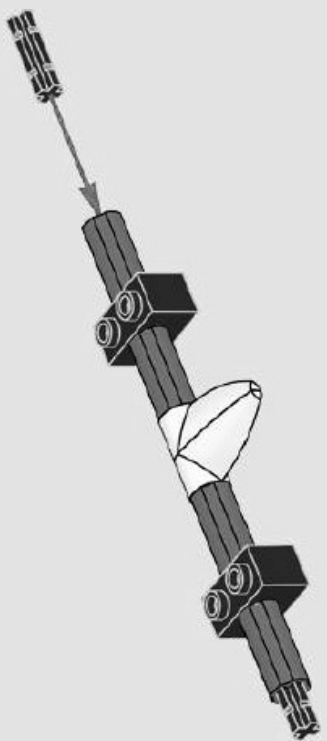



48

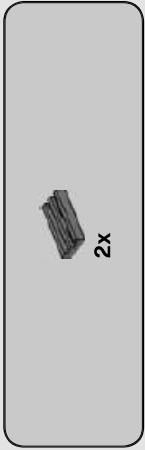
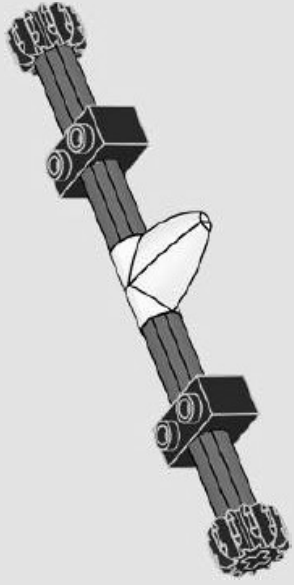

49

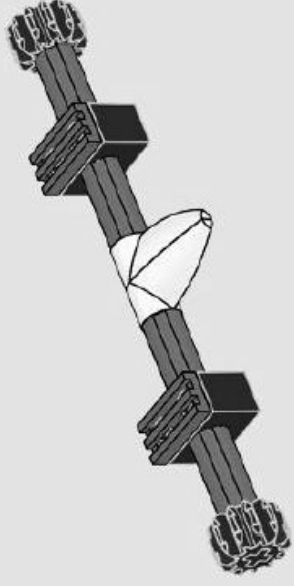

50

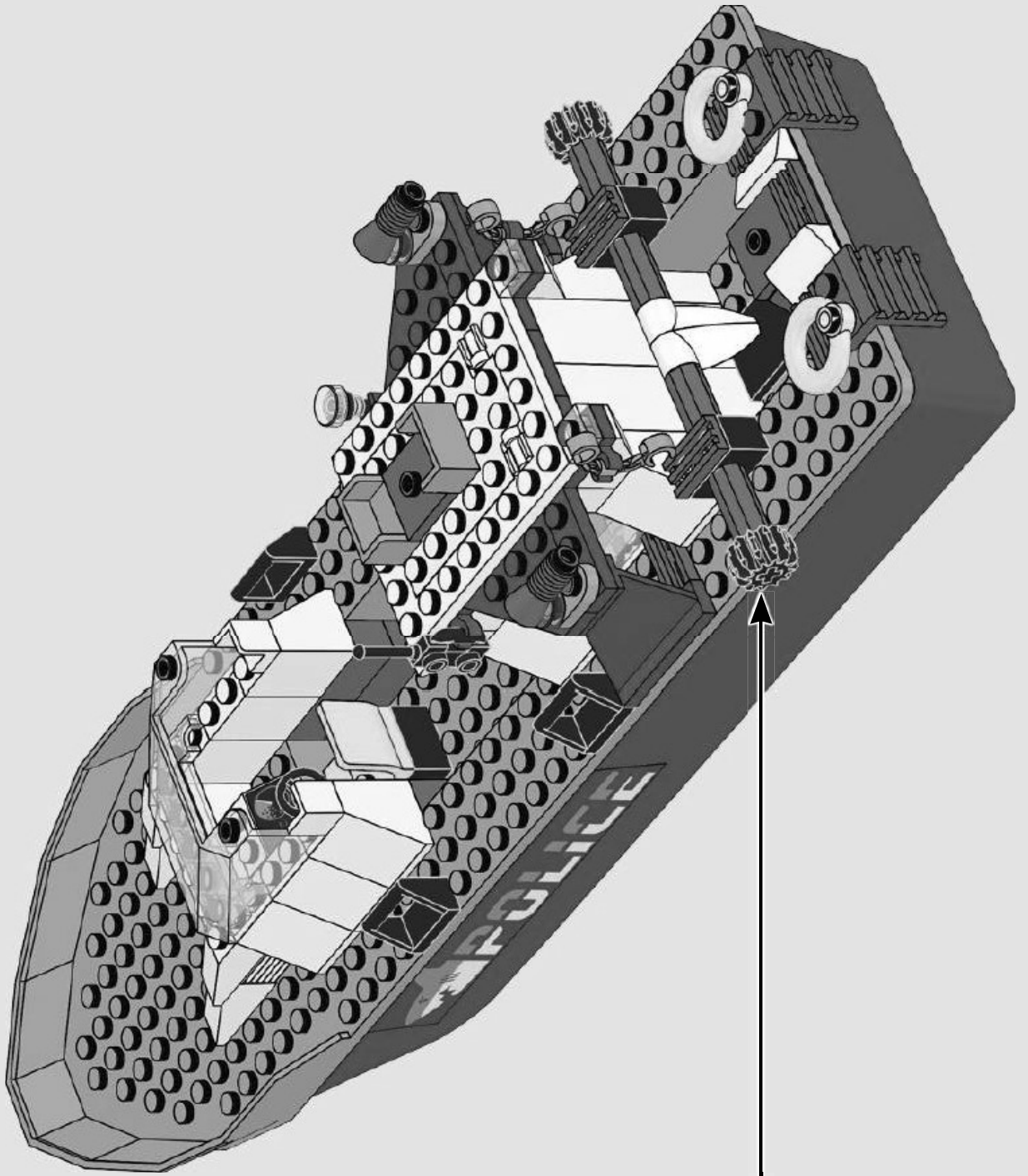

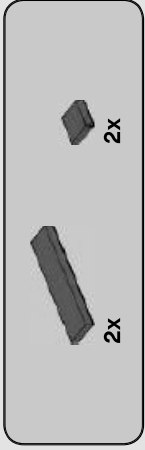

51

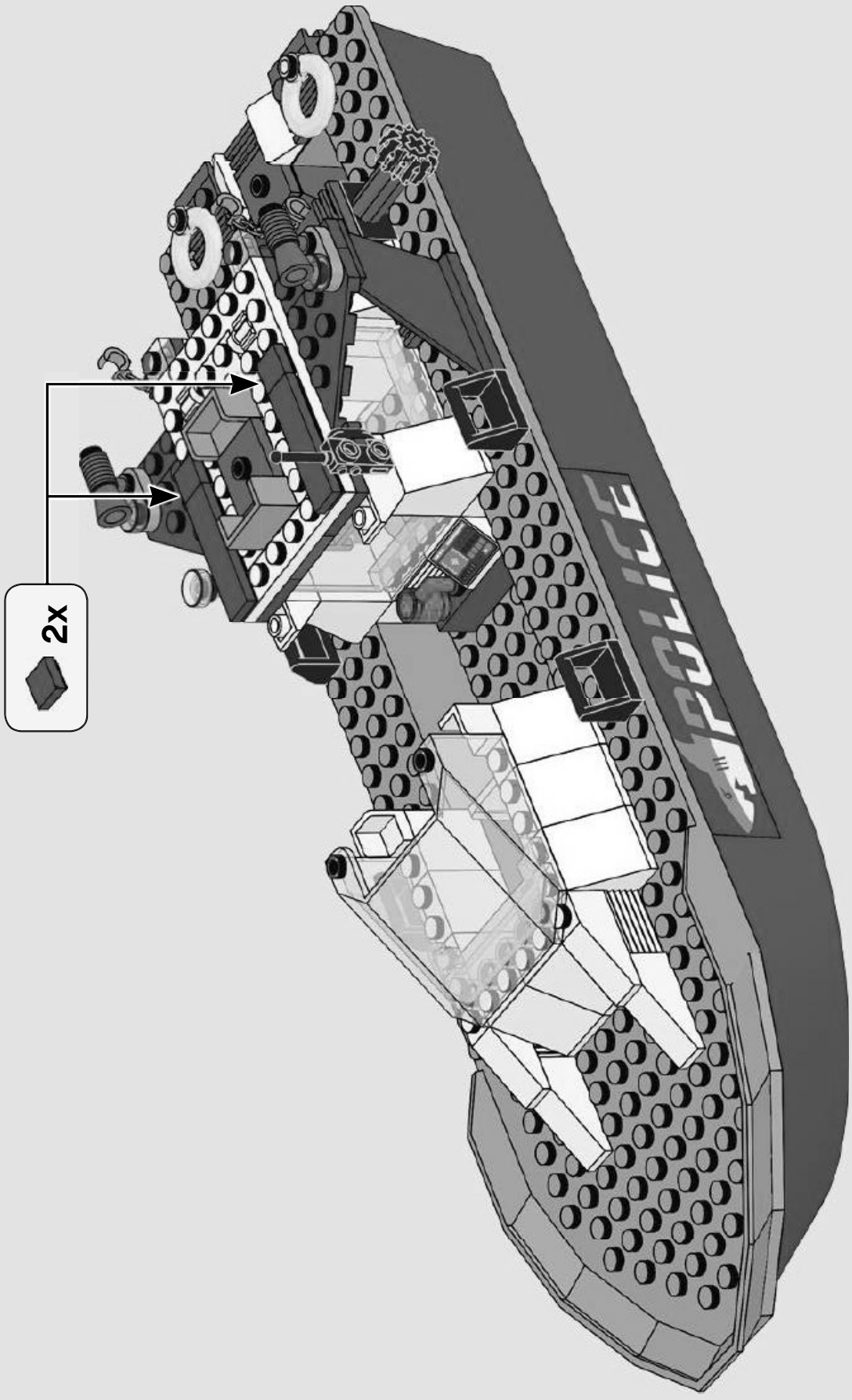

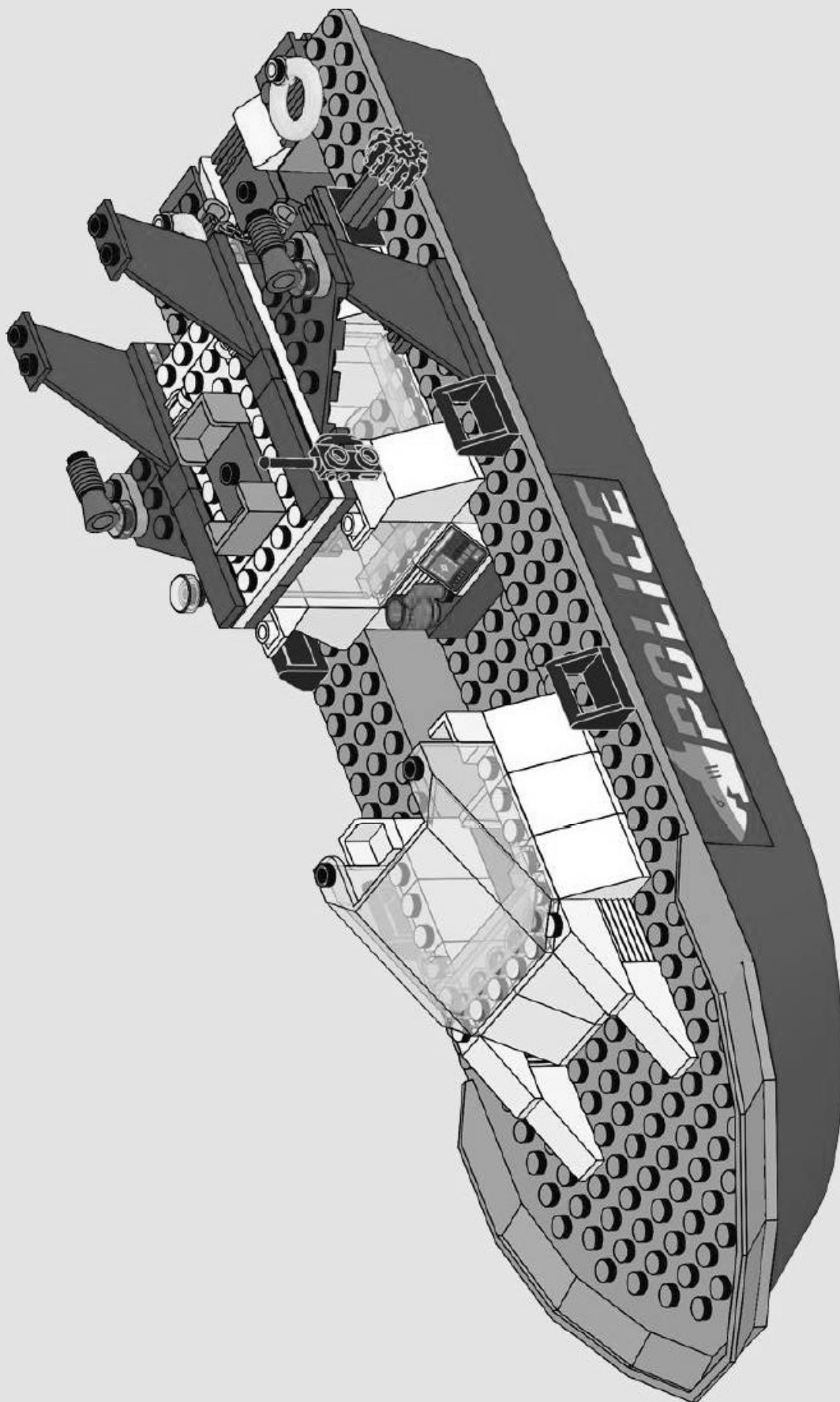

2x

52

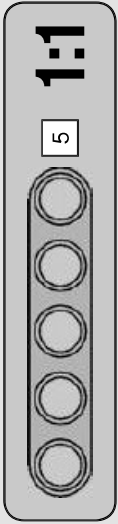
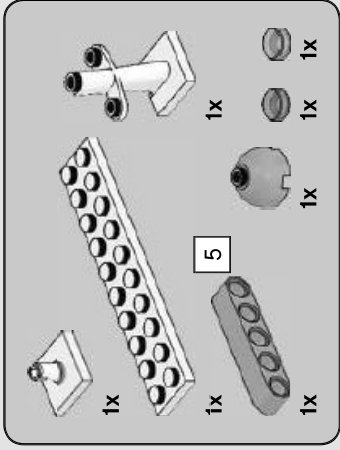

53

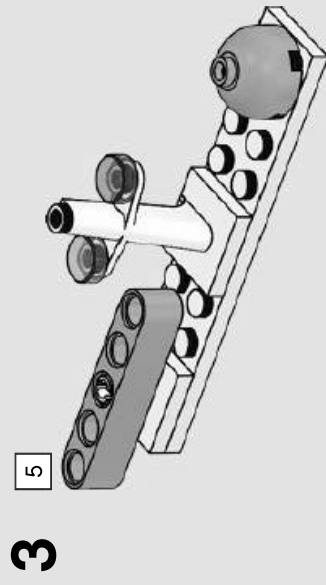
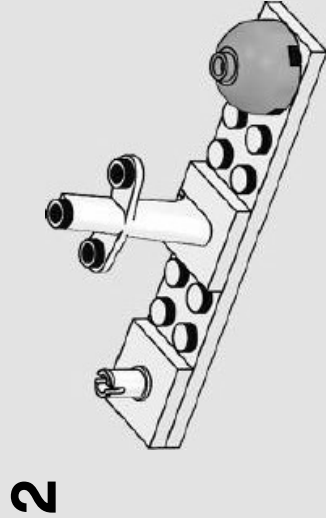
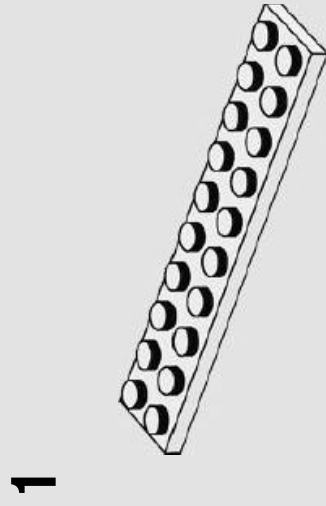

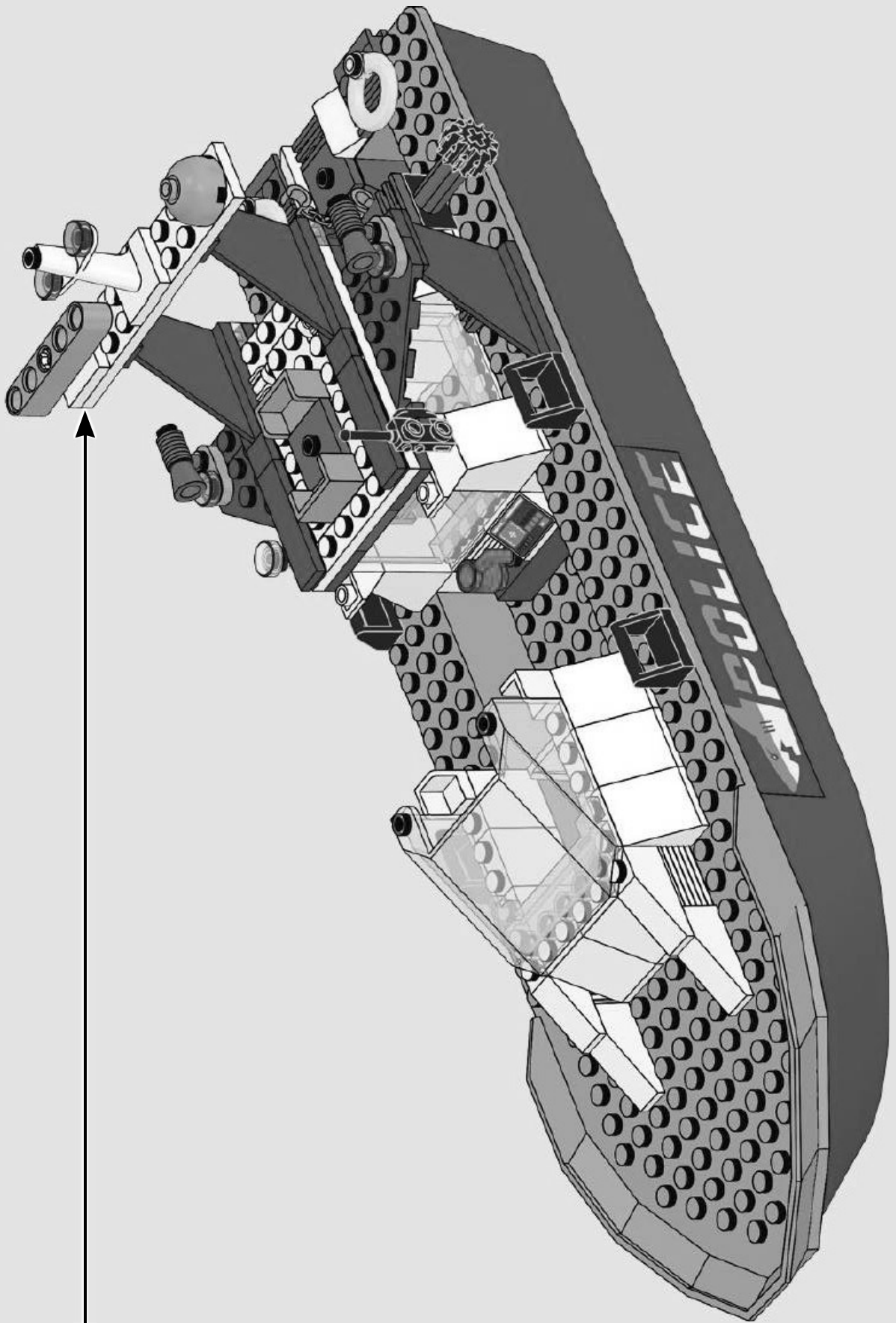

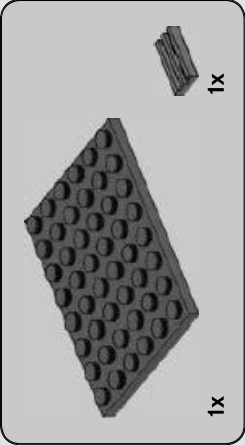

54

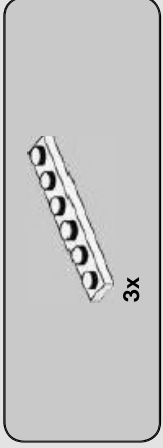

55

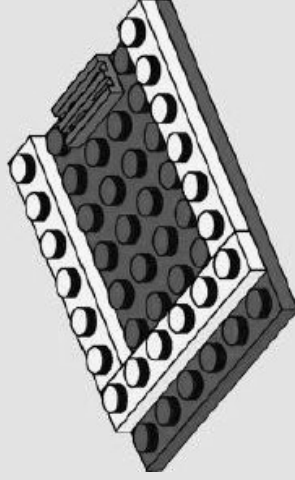



56

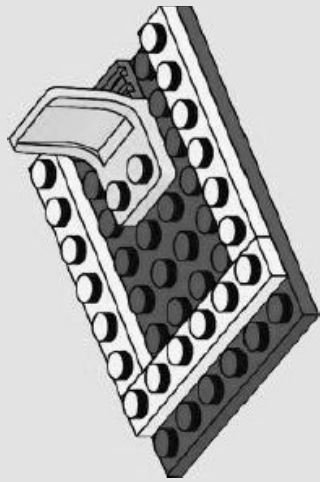

57

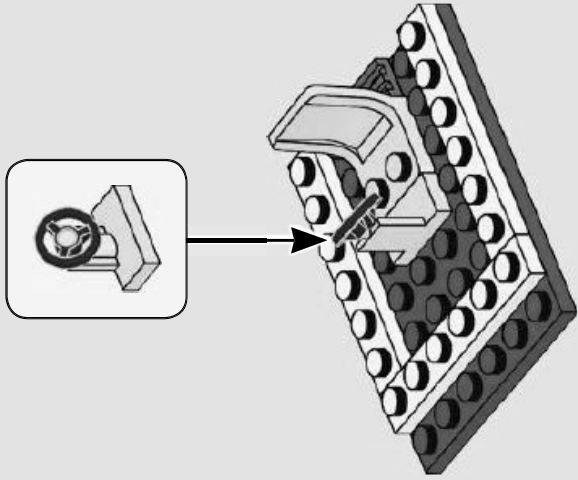

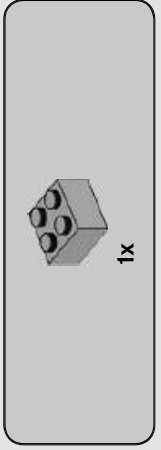

1x

58

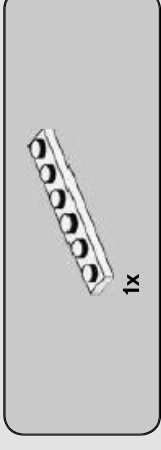
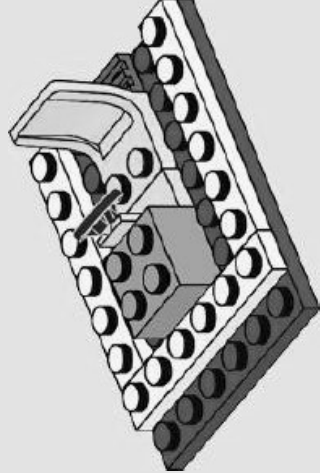

1x

59

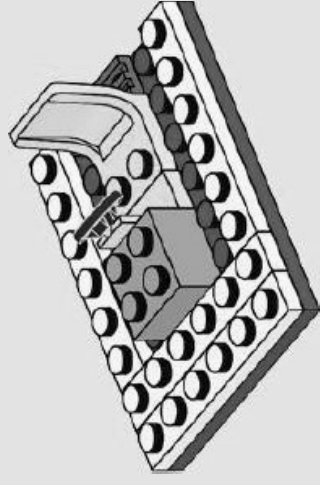

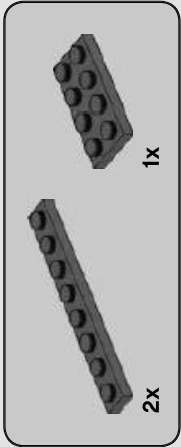

60

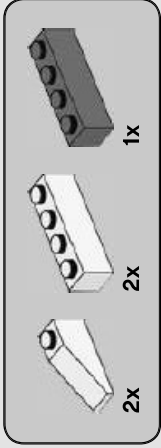
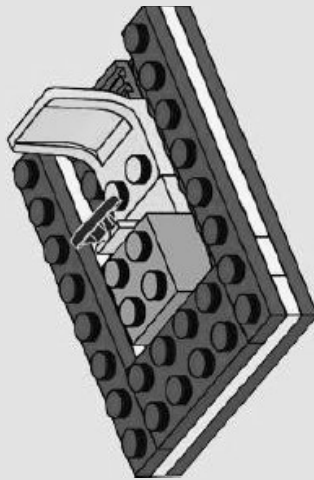

61

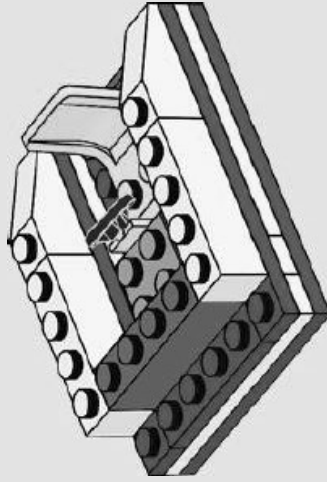



62

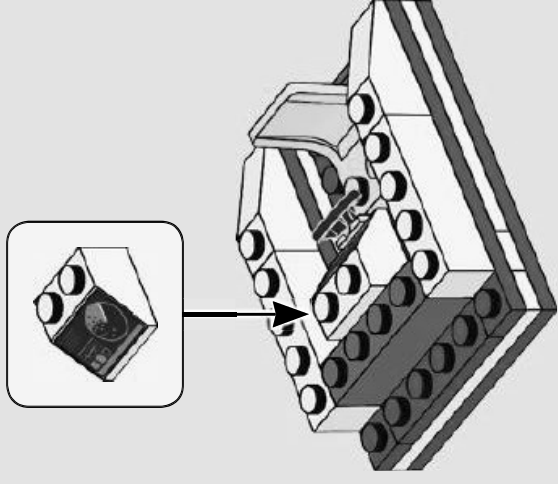

63

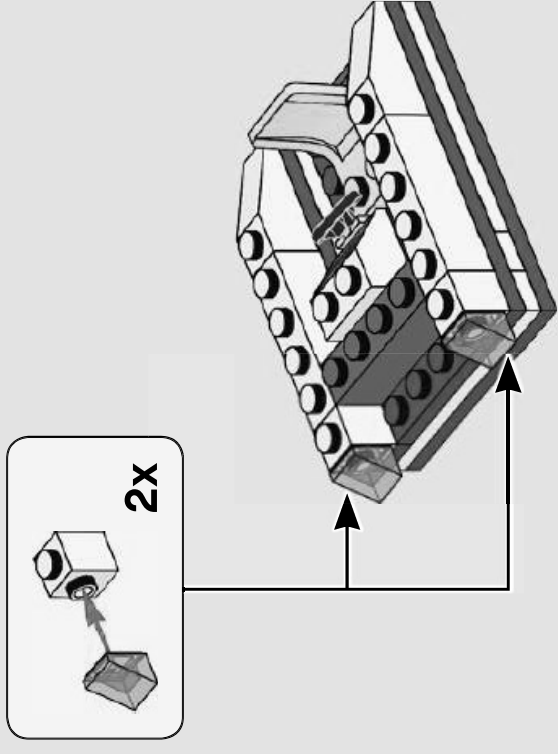

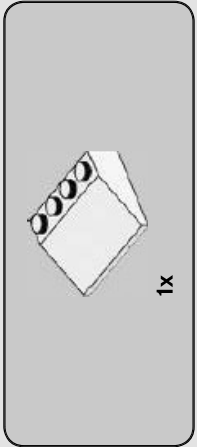

64

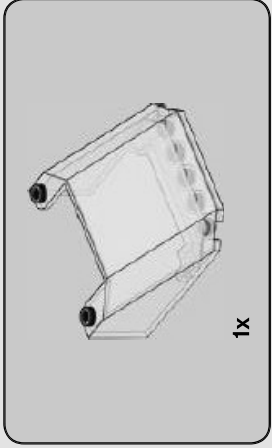
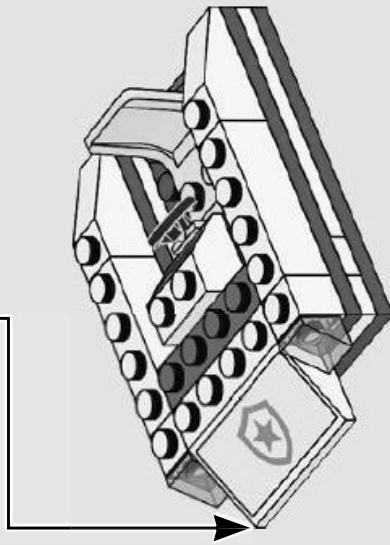
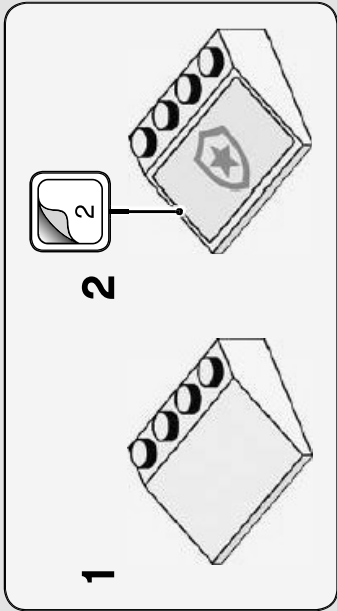

65

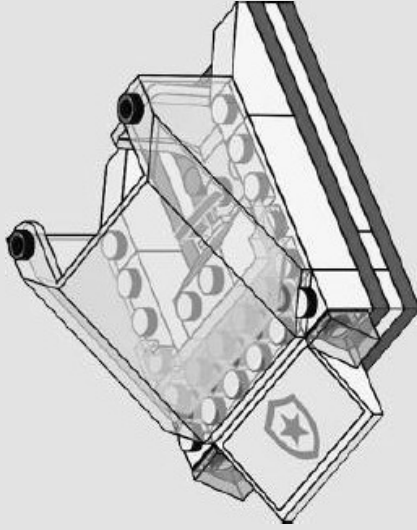

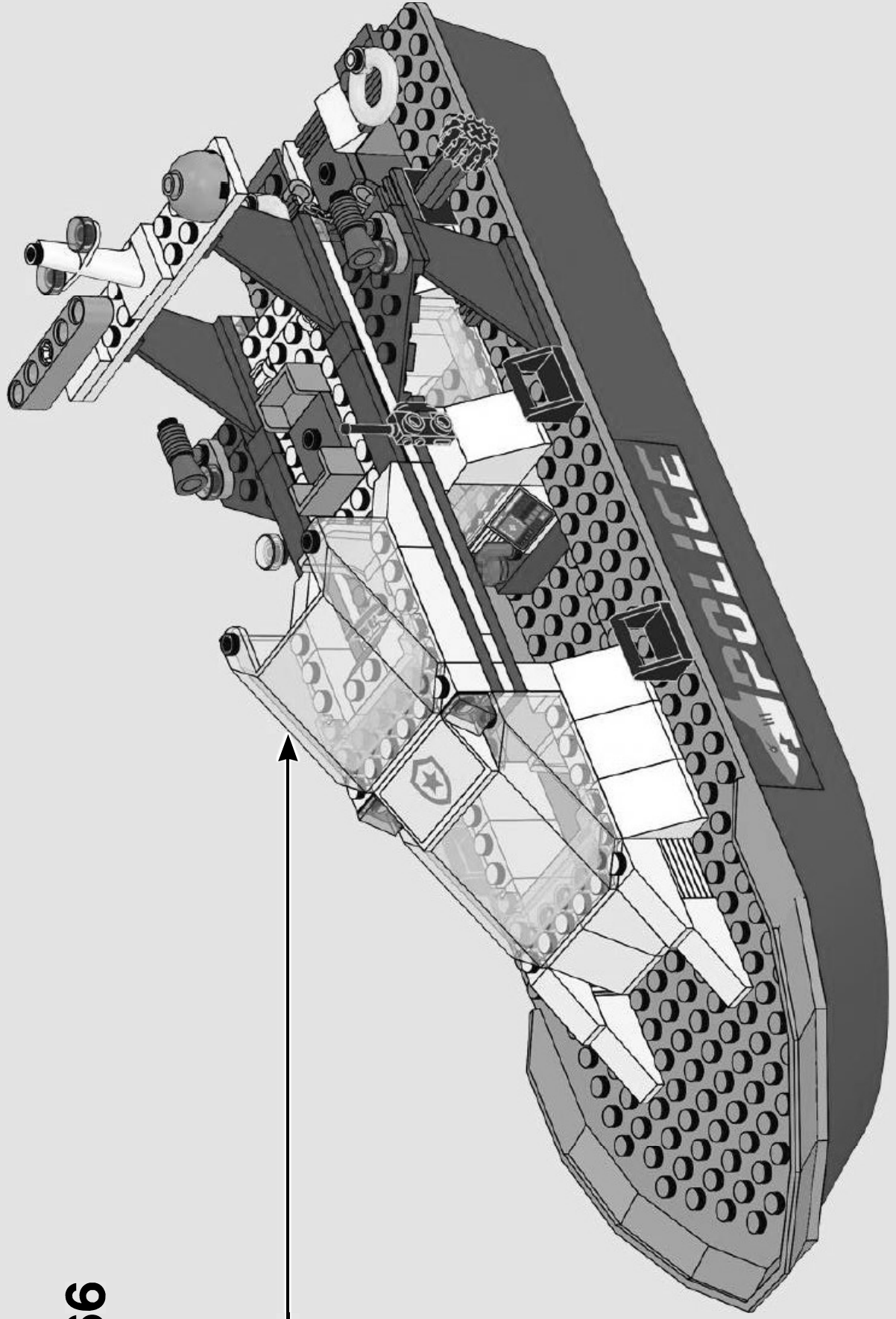

66

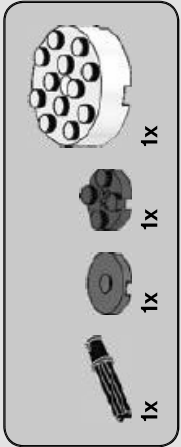

67

1



2

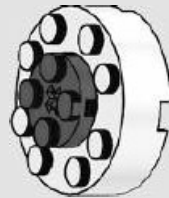

3

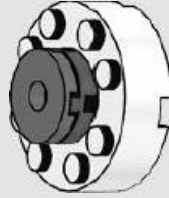

4

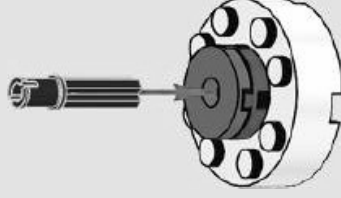

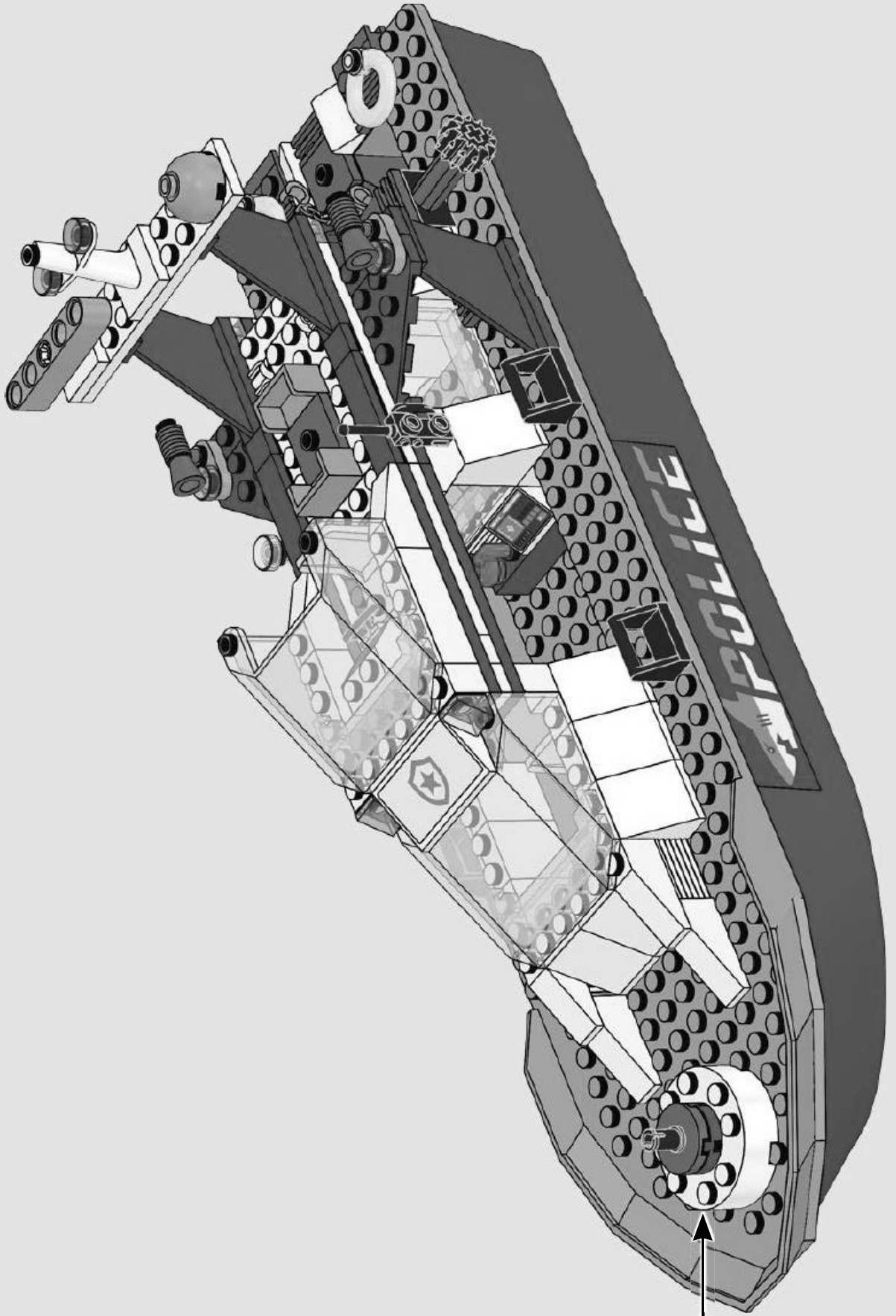

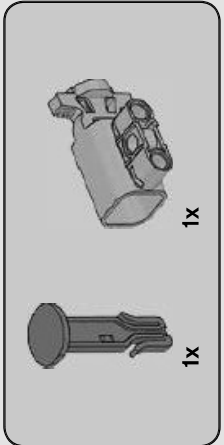
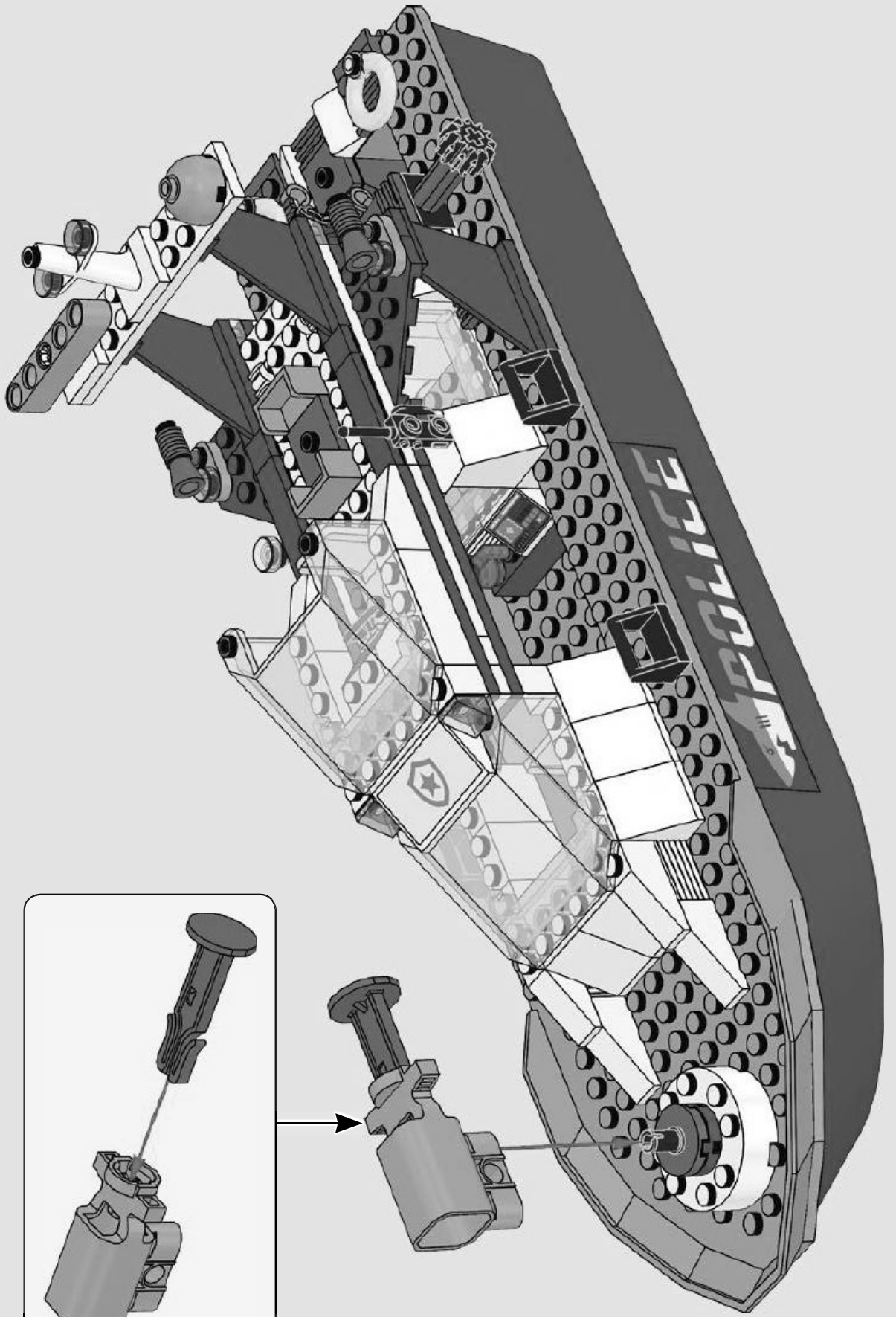

68



69



70

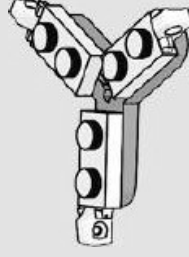



71

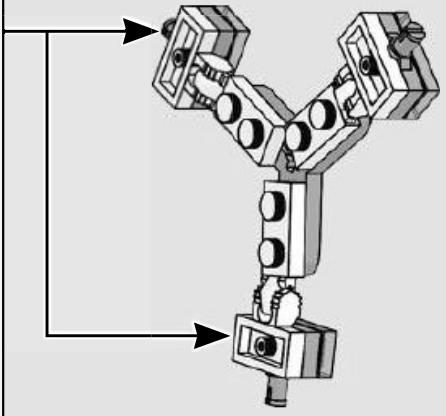
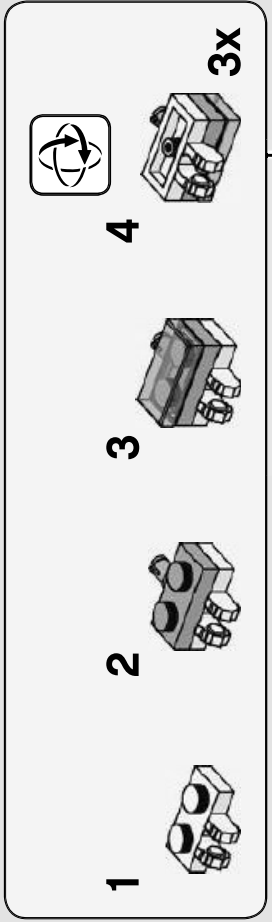

72

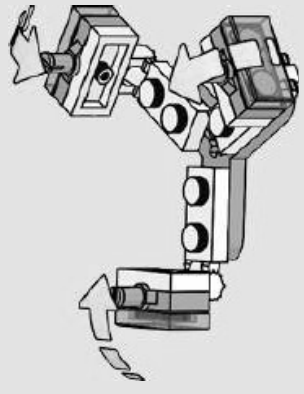



73

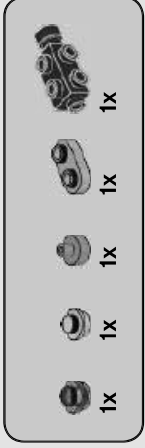
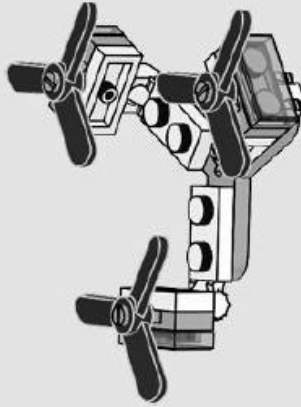

74

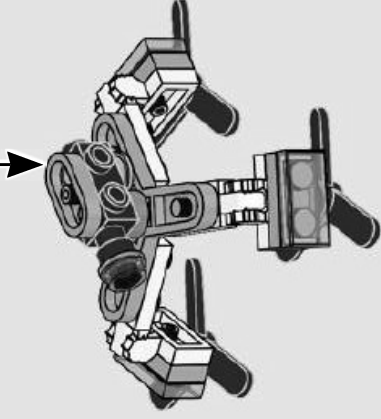

75

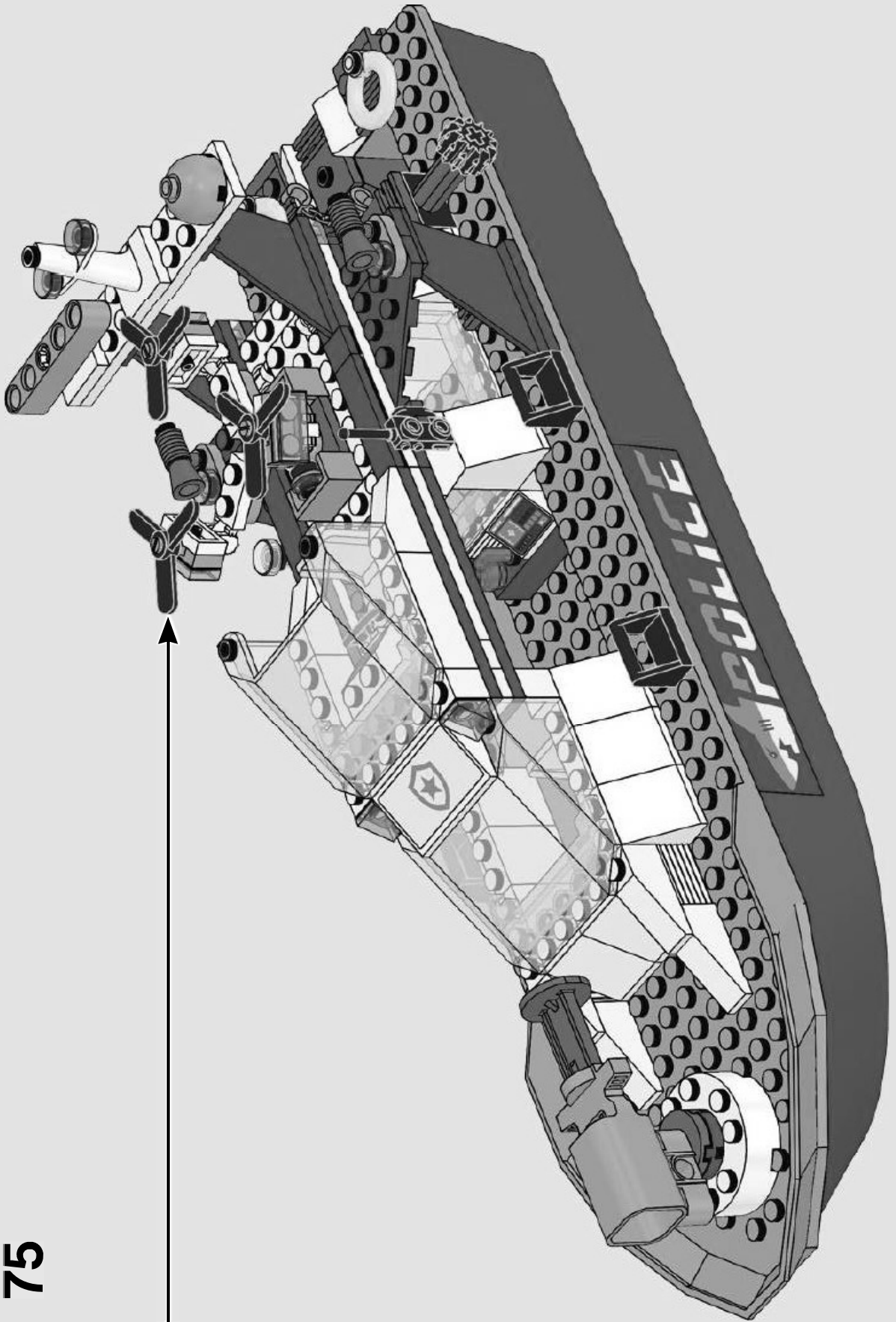

1

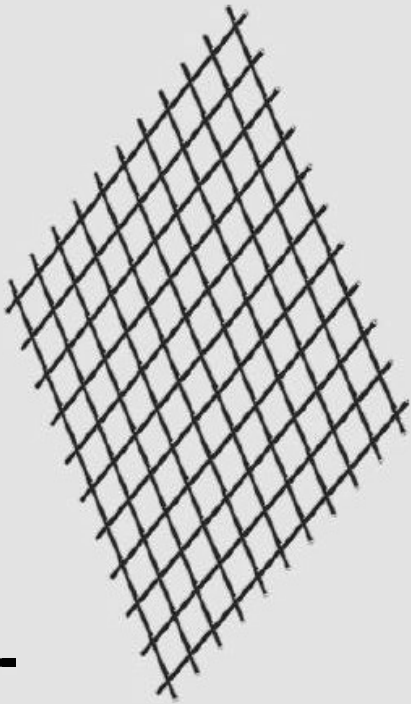

2

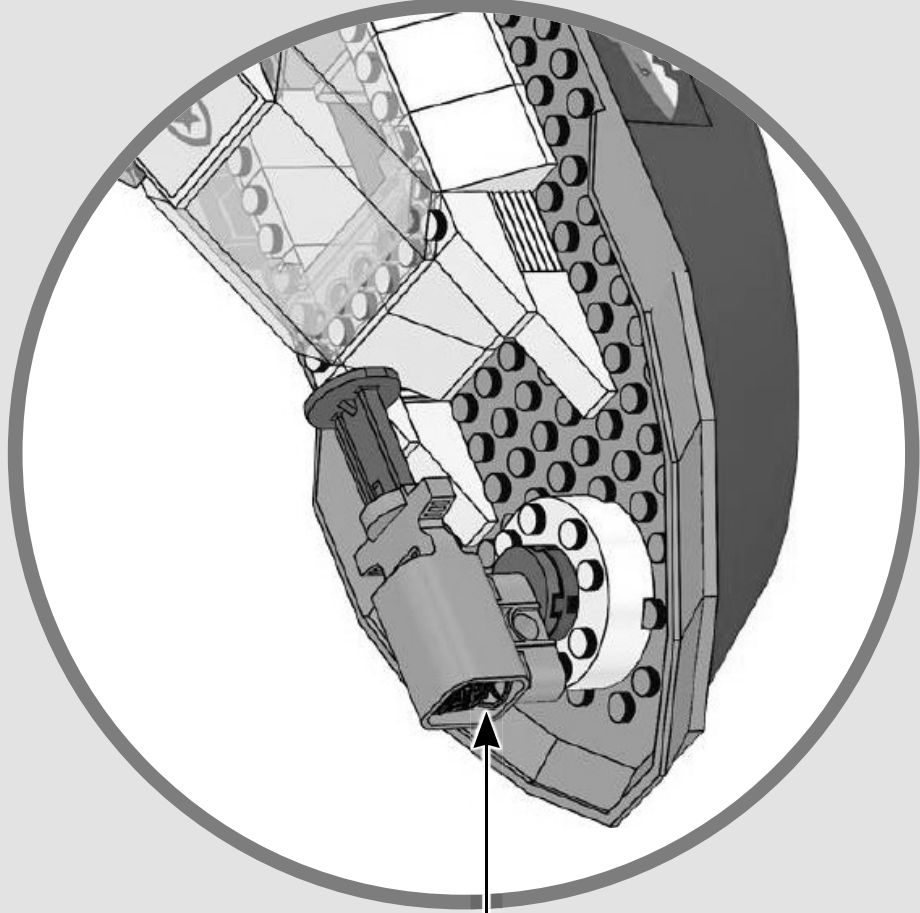

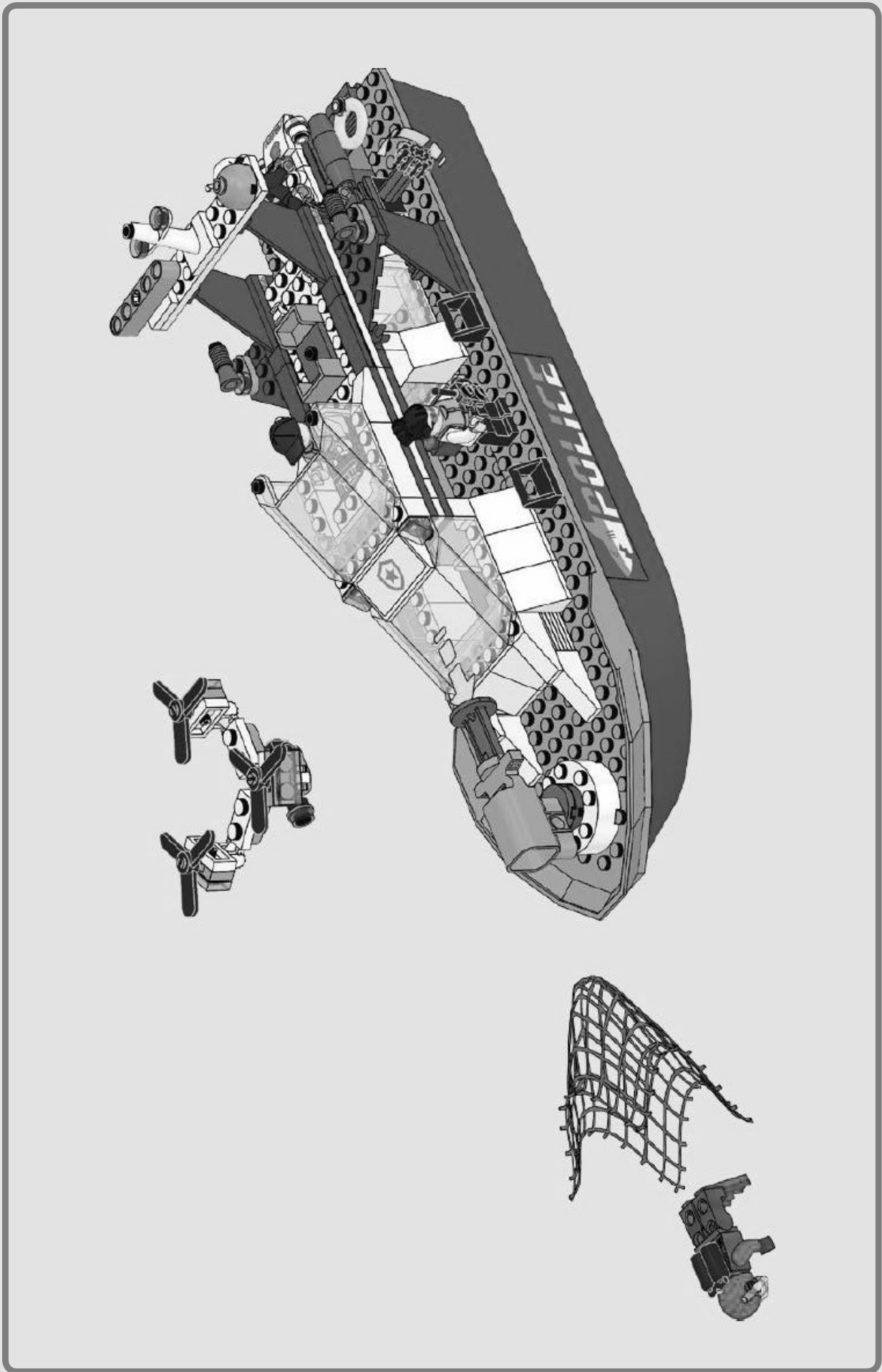

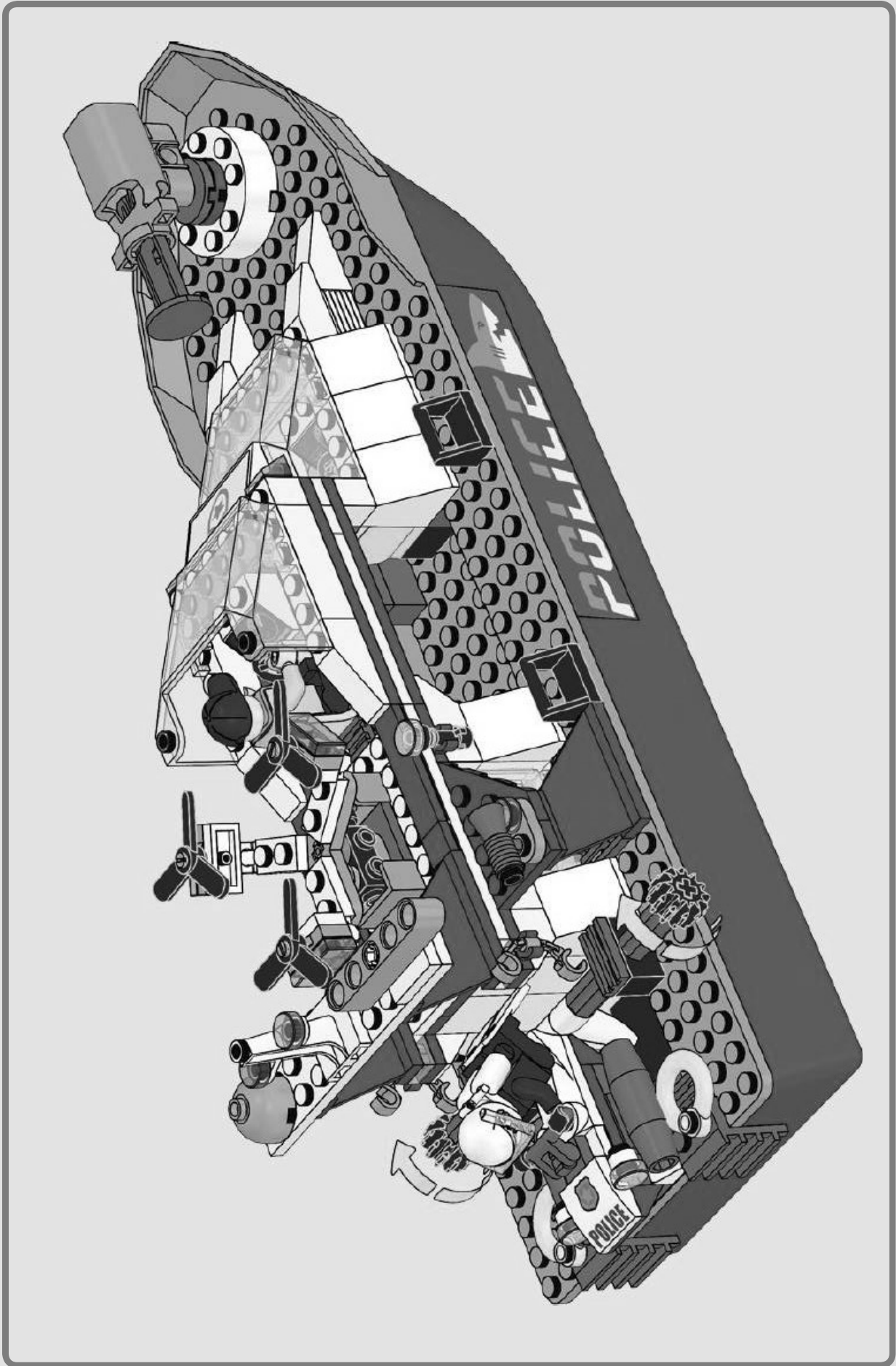

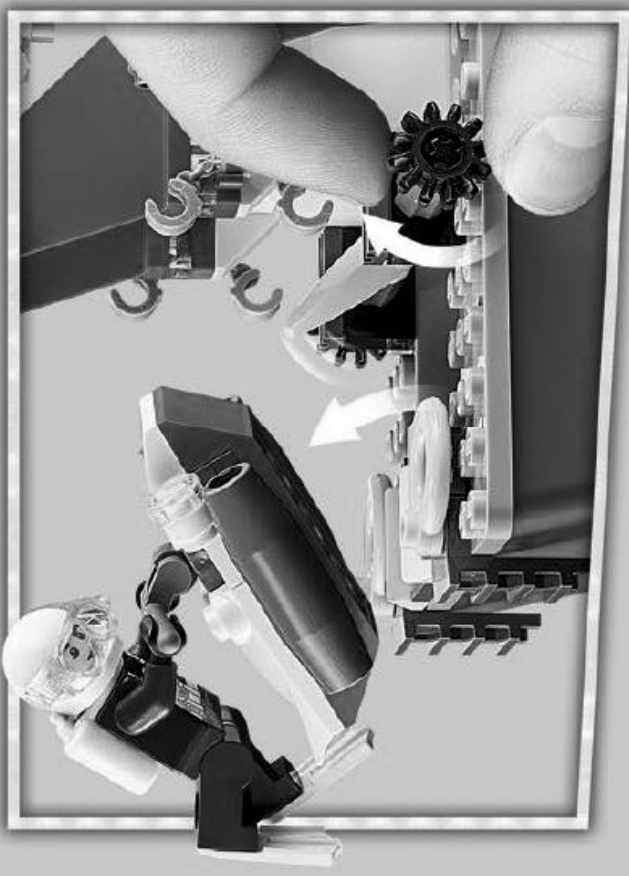
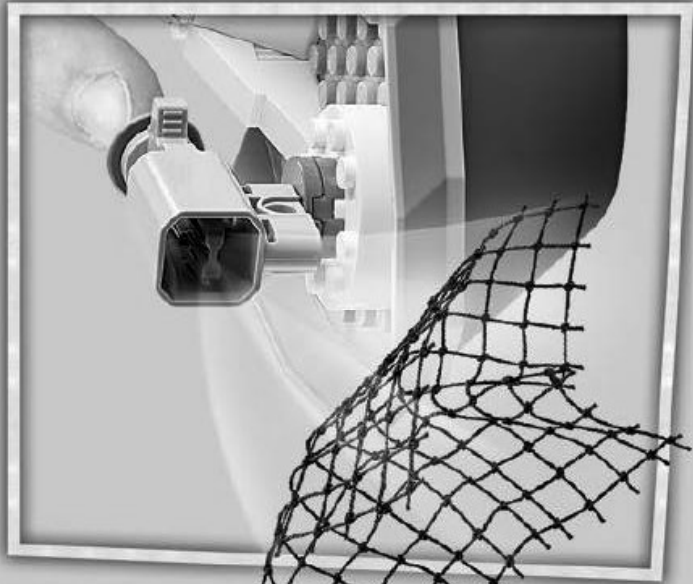



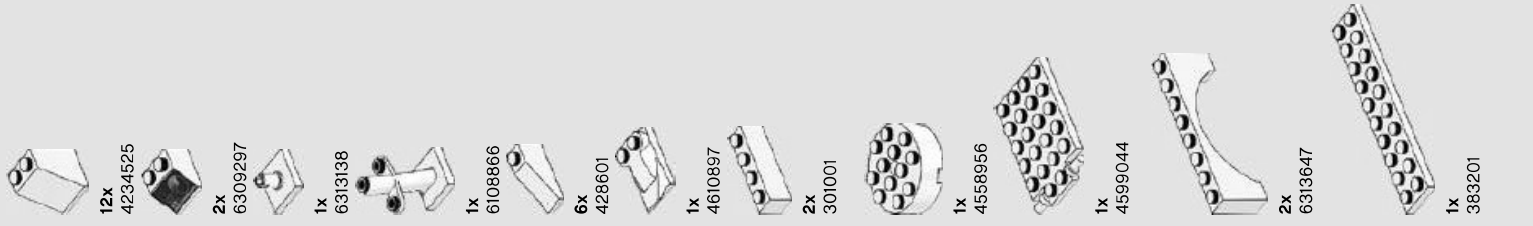
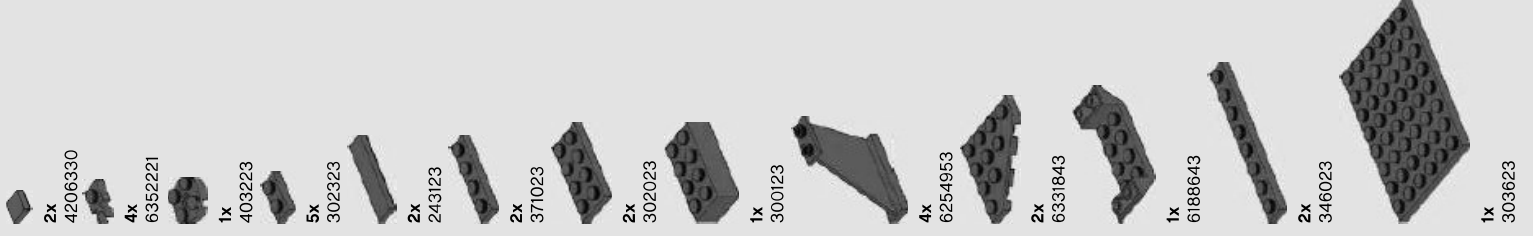

4

- 3x 6125569
- 4x 6248890
- 1x 4211637
- 2x 6248492
- 2x 4641048
- 1x 6126082
- 1x 4211387
- 1x 4610112
- 1x 6307999
- 1x 4211651
- 1x 6252349
- 1x 4211406
- 1x 6331215

- 1x 6142309
- 1x 6208450
- 2x 6258607
- 5x 6274740
- 2x 6252045
- 2x 6244761
- 3x 6245267
- 1x 6245240
- 2x 6332850

- 2x 6274742
- 1x 6288002
- 1x 6301547
- 1x 6021844
- 1x 6211710
- 1x 6328351
- 2x 9553
- 2x 4527354
- 2x 6130007
- 2x 407924
- 2x 6296510
- 2x 6331847
- 4x 6211356
- 1x 6331845

- 1x 6344022
- 2x 4210698
- 1x 6055313
- 1x 6217847
- 4x 4516546
- 1x 4222693
- 3x 4211063
- 1x 6197015
- 1x 6107827
- 2x 6107171
- 5x 4211103
- 1x 6044722
- 1x 6258887

- 8x 4210631
- 1x 4210811
- 3x 6285244
- 1x 4261908
- 2x 6126083
- 1x 4234534
- 2x 6231925
- 1x 6056241
- 2x 4162916
- 1x 6236969

- 1x 4633691
- 1x 6158322
- 1x 6301980
- 4x 6207933
- 3x 6300320
- 2x 6245256
- 3x 6251289
- 1x 6332161
- 1x 6302503
- 1x 6172536
- 1x 6332017

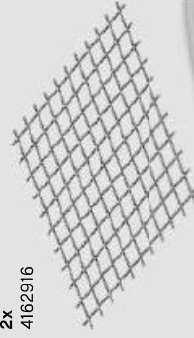

Customer Service
 Kundenservice
 Service Consommateurs
 Servicio Al Consumidor
LEGO.com/service or dial
 : 00800 5346 5555
 : 1-800-422-5346

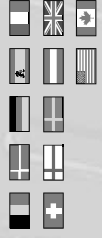

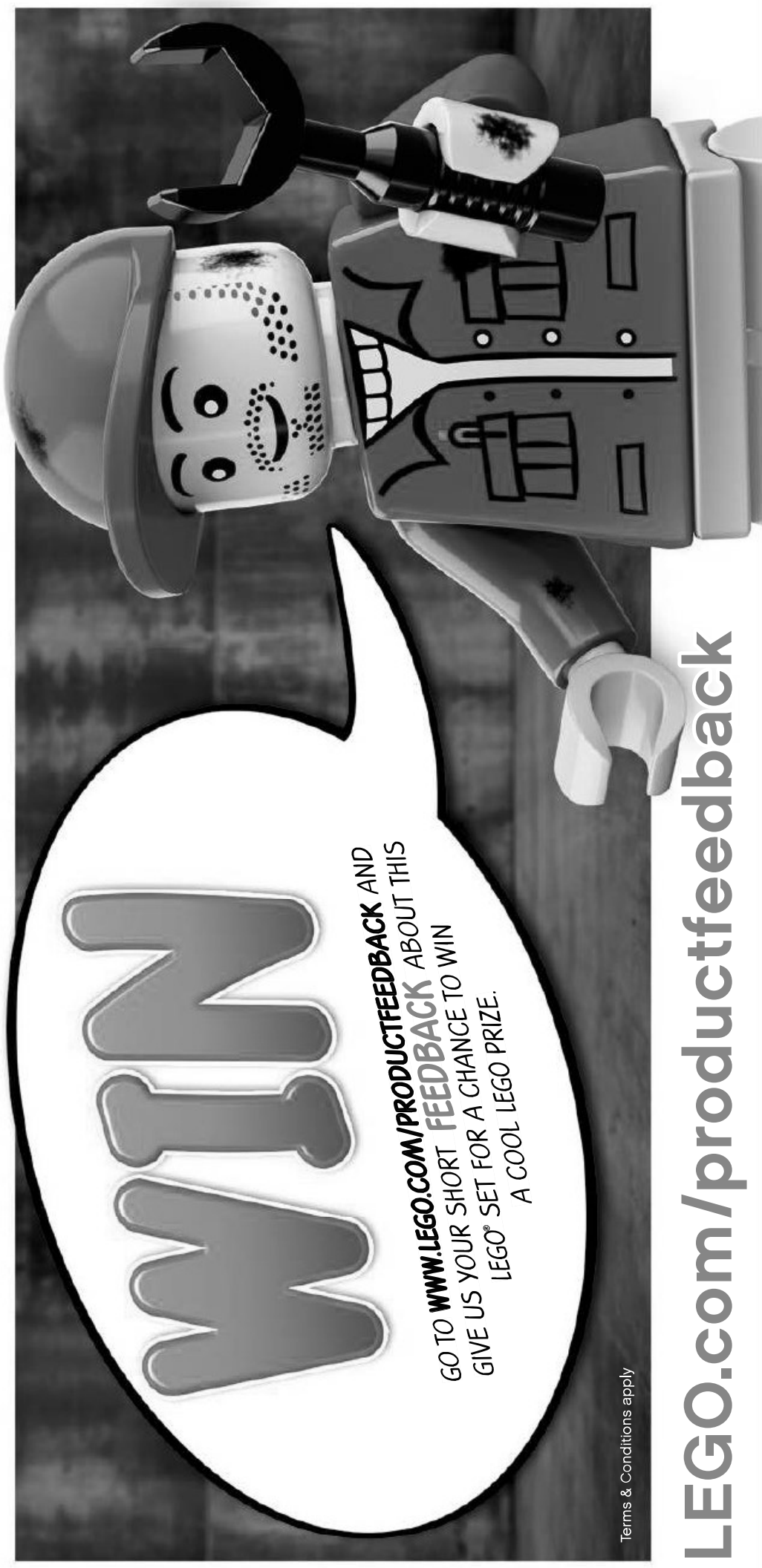

Terms & Conditions apply

LEGO.com/productfeedback

GEWINNE

Erzähle uns auf www.LEGO.com/productfeedback etwas über die Erfahrungen, die du mit diesem LEGO® Set gemacht hast, und sichere dir die Chance auf einen coolen LEGO Preis!
Es gelten die Teilnahmebedingungen

GAGNE

Rends-toi sur www.LEGO.com/productfeedback et donne-nous quelques commentaires sur ce produit LEGO® pour avoir une chance de gagner un prix LEGO !
Voir Conditions Générales

GANA

Visita www.LEGO.com/productfeedback y envíanos tu opinión acerca de este set LEGO®. ¡Participarás en el sorteo de un premio LEGO!
Términos y Condiciones aplicables

获取奖品

登录 www.LEGO.com/productfeedback 给出关于此乐高®套装的简短反馈，就有机会获得炫酷乐高奖品
《条款及条件》适用

경품 당첨 기회

www.LEGO.com/productfeedback
페이지로 이동하여 이 레고® 세트에 대한 간단한 피드백을 보내 주시고 멋진 레고 장품을 탈 수 있는 기회도 잡으십시오
약관 적용

ЗАПОЛНИ АНКЕТУ И ПОЛУЧИ ПРИЗ

Перейди по ссылке www.LEGO.com/productfeedback ответить всего на несколько вопросов об этом наборе LEGO®, и у тебя появится шанс выиграть замечательный приз от компании LEGO.
Применяются Условия и правила участия